

Sichuan AI-Link Technology Co., Ltd.

RF TEST REPORT

Report Type:

FCC Part 15.407 & ISED RSS-247 RF report

Model:

WF-M605-UWD1,WF-M605-UWD2,AL-7605B-WG-A

REPORT NUMBER:

211001862SHA-002

ISSUE DATE:

January 5, 2022

DOCUMENT CONTROL NUMBER:

TTRF15.407_V1 © 2018 Intertek



Applicant: Sichuan AI-Link Technology Co., Ltd.
Anzhou, Industrial park, Mianyang, Sichuan, China

Manufacturer: Sichuan AI-Link Technology Co., Ltd.
Anzhou, Industrial park, Mianyang, Sichuan, China

Product Name: WIFI Module

Type/Model: WF-M605-UWD1,WF-M605-UWD2,AL-7605B-WG-A

FCC ID: 2AOKI-AL7605B

IC: 23460-AL7605B

SUMMARY:

The equipment complies with the requirements according to the following standard(s) or Specification:

47CFR Part 15 (2019): Radio Frequency Devices (Subpart C)

ANSI C63.10 (2013): American National Standard of Procedures for Compliance Testing of Unlicensed Wireless Devices

RSS-247 Issue 2 (February 2017): Digital Transmission Systems (DTSS), Frequency Hopping Systems (FHSs) and Licence-Exempt Local Area Network (LE-LAN) Devices

RSS-Gen Issue 5 (March 2019) Amendment 1: General Requirements for Compliance of Radio Apparatus

PREPARED BY:

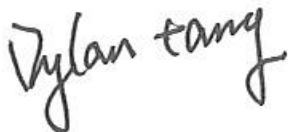

Project Engineer
Dylan Tang

REVIEWED BY:



Reviewer
Daniel Zhao

This report is for the exclusive use of Intertek's Client and is provided pursuant to the agreement between Intertek and its Client. Intertek's responsibility and liability are limited to the terms and conditions of the agreement. Intertek assumes no liability to any party, other than to the Client in accordance with the agreement, for any loss, expense or damage occasioned by the use of this report. Only the Client is authorized to permit copying or distribution of this report and then only in its entirety. Any use of the Intertek name or one of its marks for the sale or advertisement of the tested material, product or service must first be approved in writing by Intertek. The observations and test results in this report are relevant only to the sample tested. This report by itself does not imply that the material, product, or service is or has ever been under an Intertek certification program.

TEST REPORT

Content

REVISION HISTORY.....	5
MEASUREMENT RESULT SUMMARY	6
1 GENERAL INFORMATION	7
1.1 DESCRIPTION OF EQUIPMENT UNDER TEST (EUT)	7
1.2 TECHNICAL SPECIFICATION	7
1.3 WORKING FREQUENCIES FOR THIS REPORT	8
1.4 ANTENNA INFORMATION.....	9
1.5 DESCRIPTION OF TEST FACILITY	9
2 TEST SPECIFICATIONS.....	10
2.1 STANDARDS OR SPECIFICATION	10
2.2 MODE OF OPERATION DURING THE TEST.....	10
2.3 TEST SOFTWARE LIST	12
2.4 TEST PERIPHERALS LIST	12
2.5 TEST ENVIRONMENT CONDITION:.....	12
2.6 INSTRUMENT LIST	13
2.7 MEASUREMENT UNCERTAINTY	14
3 26 DB BANDWIDTH & 99% OCCUPIED BANDWIDTH	15
3.1 LIMIT	15
3.2 MEASUREMENT PROCEDURE	15
3.3 TEST CONFIGURATION	16
3.4 THE RESULTS OF 26 DB BANDWIDTH & 99% OCCUPIED BANDWIDTH	16
4 MINIMUM 6DB BANDWIDTH.....	17
4.1 LIMIT	17
4.2 MEASUREMENT PROCEDURE	17
4.3 TEST CONFIGURATION	17
4.4 THE RESULTS OF MINIMUM 6dB BANDWIDTH	17
5 MAXIMUM CONDUCTED OUTPUT POWER AND E.I.R.P.....	18
5.1 LIMIT	18
5.2 MEASUREMENT PROCEDURE	19
5.3 TEST CONFIGURATION	19
5.4 TEST RESULTS OF MAXIMUM CONDUCTED OUTPUT POWER AND E.I.R.P.....	19
6 POWER SPECTRUM DENSITY	20
6.1 LIMIT	20
6.2 MEASUREMENT PROCEDURE	21
6.3 TEST CONFIGURATION	22
6.4 TEST RESULTS OF POWER SPECTRUM DENSITY	22
7 RADIATED EMISSIONS	23
7.1 LIMIT	23
7.2 MEASUREMENT PROCEDURE	24
7.3 TEST CONFIGURATION	25
7.4 TEST RESULTS OF RADIATED EMISSIONS	27
8 POWER LINE CONDUCTED EMISSION.....	36
8.1 LIMIT	36

TEST REPORT

8.2	TEST CONFIGURATION	36
8.3	36
8.4	MEASUREMENT PROCEDURE	37
8.5	TEST RESULTS OF POWER LINE CONDUCTED EMISSION.....	38
9	FREQUENCY STABILITY	40
9.1	LIMIT	40
9.2	TEST RESULT.....	40
10	ANTENNA REQUIREMENT	41

Revision History

Report No.	Version	Description	Issued Date
211001862SHA-002	Rev. 01	Initial issue of report	January 5, 2022

Measurement result summary

TEST ITEM	FCC REFERENCE	IC REFERENCE	RESULT
26 dB Bandwidth & 99% Occupied Bandwidth	15.407(a)	RSS-247 Issue 2 Clause 6	Pass
Minimum 6dB Bandwidth	15.407(e)	RSS-247 Issue 2 Clause 6	Pass
Maximum Conducted Output Power	15.407(a)	RSS-247 Issue 2 Clause 6	Pass
Power spectral density	15.407(a)	RSS-247 Issue 2 Clause 6	Pass
Radiated emission	15.407(b) 15.205 15.209	RSS-247 Issue 2 Clause 6 RSS-Gen Issue 5 Clause 8.9&8.10	Pass
Power line conducted emission	15.407(b) 15.207	RSS-Gen Issue 5 Clause 8.8	Pass
Frequency Stability	15.407(g)	RSS-Gen Issue 5 Clause 8.11	Pass
Antenna requirement	15.203	-	Pass

Notes: 1: NA =Not Applicable

2. Determination of the test conclusion is based on IEC Guide 115 in consideration of measurement uncertainty.

3: Additions, Deviations and Exclusions from Standards: None.

1 GENERAL INFORMATION

1.1 Description of Equipment Under Test (EUT)

Product name:	WIFI Module
Type/Model:	WF-M605-UWD1,WF-M605-UWD2,AL-7605B-WG-A
Description of EUT:	The EUT is a WIFI module which supports 802.11a/b/g/n mode, there have three models and they are same except the connector. We choose WF-M605-UWD1 to test as representative.
Rating:	DC 3.3V
EUT type:	<input checked="" type="checkbox"/> Table top <input type="checkbox"/> Floor standing
Product Marketing Name:	WF-M605-UWD1,WF-M605-UWD2,AL-7605B-WG-A
HVIN:	WF-M605-UWD1,WF-M605-UWD2,AL-7605B-WG-A
Software Version:	UIV2.06
Hardware Version:	JUI7.820.1011
Serial numbers:	0211022-65-001(for radiation sample) 0211022-65-002(for conduction sample)
Sample received date:	October 31, 2021
Date of test:	November 3, 2021 ~ January 5, 2022

1.2 Technical Specification

FCC

Frequency Range:	5150 ~ 5250MHz 5250 ~ 5350MHz 5470 ~ 5725MHz 5725 ~ 5850MHz
Support Standards:	802.11a, 802.11n(HT20), 802.11n(HT40)
Type of Modulation:	OFDM (BPSK, QPSK, 16QAM, 64QAM, 256QAM)
Channel Number:	For 5180 ~ 5240MHz band: Channel 36 - 48 For 5260 ~ 5320MHz Band: Channel 52 - 64 For 5500 ~ 5700MHz Band: Channel 100 - 140 For 5745 ~ 5825MHz band: Channel 149 - 165

IC

Frequency Range:	5150 ~ 5250MHz 5250 ~ 5350MHz 5470 ~ 5600MHz 5650~ 5725MHz 5725 ~ 5850MHz
Support Standards:	802.11a, 802.11n(HT20), 802.11n(HT40)

TEST REPORT

Type of Modulation:	OFDM (BPSK, QPSK, 16QAM, 64QAM, 256QAM)
Channel Number:	For 5180 ~ 5240MHz band: Channel 36 - 48 For 5260 ~ 5320MHz Band: Channel 52 - 64 For 5500 ~ 5580MHz Band: Channel 100 - 116 For 5660 ~ 5700MHz Band: Channel 132 - 140 For 5745 ~ 5825MHz band: Channel 149 - 165

1.3 Working Frequencies for this report

FCC

802.11a/n(HT20)					
Channel	Frequency	Channel	Frequency	Channel	Frequency
36	5180MHz	40	5200MHz	44	5220MHz
48	5240MHz	52	5260 MHz	56	5280 MHz
60	5300 MHz	64	5320 MHz	100	5500 MHz
104	5520 MHz	108	5540 MHz	112	5560 MHz
116	5580 MHz	120	5600 MHz	124	5620 MHz
128	5640 MHz	132	5660 MHz	136	5680 MHz
140	5700 MHz	149	5745 MHz	153	5765 MHz
157	5785 MHz	161	5805 MHz	165	5825 MHz
802.11n(HT40)					
Channel	Frequency	Channel	Frequency	Channel	Frequency
38	5190MHz	46	5230MHz	54	5270 MHz
62	5310 MHz	102	5510 MHz	110	5550MHz
118	5590 MHz	126	5630 MHz	134	5670 MHz
151	5755 MHz	159	5795 MHz	-	-

IC

802.11a/n(HT20)					
Channel	Frequency	Channel	Frequency	Channel	Frequency
36	5180MHz	40	5200MHz	44	5220MHz
48	5240MHz	52	5260 MHz	56	5280 MHz
60	5300 MHz	64	5320 MHz	100	5500 MHz
104	5520 MHz	108	5540 MHz	112	5560 MHz
116	5580 MHz	132	5660 MHz	136	5680 MHz
140	5700 MHz	149	5745 MHz	153	5765 MHz
157	5785 MHz	161	5805 MHz	165	5825 MHz
802.11n(HT40)					
Channel	Frequency	Channel	Frequency	Channel	Frequency

TEST REPORT

38	5190MHz	46	5230MHz	54	5270 MHz
62	5310 MHz	102	5510 MHz	110	5550MHz
134	5670 MHz	151	5755 MHz	159	5795 MHz

1.4 Antenna information

Antenna information:			
No.	Antenna Type	Gain	Note
1	PIFA Antenna	3.68dBi	On Board type
2	PIFA Antenna	3.37dBi	External type
		2.57dBi	External optional type

Mode	Tx/Rx Function	Beamforming function	CDD function	Directional gain (dBi)
802.11a	1Tx/1Rx	NO	NO	-
802.11n(HT20)	2Tx/2Rx	NO	NO	-
802.11n(HT40)	2Tx/1Rx	NO	NO	-

Note: For 802.11a mode, it only supports 1TX.
 For 802.11n modes, it can support 2TX, all the two transmit signals are completely uncorrelated with each other, so the directional gain = $10 \log ((10^{G1/10} + 10^{G2/10} + \dots + 10^{Gn/10}) / N_{ANT})$

1.5 Description of Test Facility

Name:	Intertek Testing Services Shanghai
Address:	Building 86, No. 1198 Qinzhou Road(North), Shanghai 200233, P.R. China
Telephone:	86 21 61278200
Telefax:	86 21 54262353

The test facility is recognized, certified, or accredited by these organizations:	CNAS Accreditation Lab Registration No. CNAS L0139
	FCC Accredited Lab Designation Number: CN1175
	IC Registration Lab CAB identifier.: CN0051
	VCCI Registration Lab Registration No.: R-14243, G-10845, C-14723, T-12252
	A2LA Accreditation Lab Certificate Number: 3309.02

2 TEST SPECIFICATIONS

2.1 Standards or specification

47CFR Part 15 (2019)
 ANSI C63.10 (2013)
 RSS-247 Issue 2 (February 2017)
 RSS-Gen Issue 5 (March 2019) Amendment 1
 KDB 789033 D02 v02r01

2.2 Mode of operation during the test

There have three models EUT, the Radiation emission was chosen for pretest, after this pre-scan, we find the worst-case model is “WF-M605-UWD1”, and we choose this model for all test as representative.

While testing transmitting mode of EUT, the continuously transmission was applied by following software.

Software name	Manufacturer	Version	Supplied by
MT7663 QA		0.0.2.6	Client

The lowest, middle and highest channel for the following modes were tested as representatives.

Frequency Band (MHz)	Mode	Lowest (MHz)	Middle (MHz)	Highest (MHz)
5150 - 5250	802.11a	5180	5200	5240
	802.11n(HT20)	5180	5200	5240
	802.11n(HT40)	5190	/	5230
5250 - 5350	802.11a	5260	5300	5320
	802.11n(HT20)	5260	5300	5320
	802.11n(HT40)	5270	/	5310
5470 - 5725	802.11a	5500	5580	5700
	802.11n(HT20)	5500	5580	5700
	802.11n(HT40)	5510	5550	5670
5725 - 5850	802.11a	5745	5785	5825
	802.11n(HT20)	5745	5785	5825
	802.11n(HT40)	5755	/	5795

TEST REPORT

Data rate and Power setting:

The pre-scan for the conducted power with all data rates in each modulation and band was used, and the worst case was found and used in all test cases. After this pre-scan, we choose the following table of the data rate as the worst case.

Frequency Band (MHz)	Mode	Worst case data rate
5150 - 5250	802.11a	6Mbps
	802.11n(HT20)	MCS0
	802.11n(HT40)	MCS0
5250 - 5350	802.11a	6Mbps
	802.11n(HT20)	MCS0
	802.11n(HT40)	MCS0
5500 - 5725	802.11a	6Mbps
	802.11n(HT20)	MCS0
	802.11n(HT40)	MCS0
5725 - 5850	802.11a	6Mbps
	802.11n(HT20)	MCS0
	802.11n(HT40)	MCS0

TEST REPORT

2.3 Test software list

Test Items	Software	Manufacturer	Version
Conducted emission	ESxS-K1	R&S	V2.1.0
Radiated emission	ES-K1	R&S	V1.71

2.4 Test peripherals list

Item No.	Name	Band and Model	Description
1	Laptop computer	DELL 5480	-
2	RF cable	/	0.2m length; 0.5dB loss

2.5 Test environment condition:

Test items	Temperature	Humidity
26 dB Bandwidth & 99% Occupied Bandwidth	19°C	53% RH
Minimum 6dB Bandwidth		
Maximum Conducted Output Power		
Power spectral density		
Radiated Emissions in restricted frequency bands	20°C	53% RH
Power line conducted emission	20°C	53% RH

TEST REPORT

2.6 Instrument list

Conducted Emission					
Used	Equipment	Manufacturer	Type	Internal no.	Due date
<input checked="" type="checkbox"/>	Test Receiver	R&S	ESCS 30	EC 2107	2022-07-09
<input checked="" type="checkbox"/>	A.M.N.	R&S	ESH2-Z5	EC 3119	2022-11-10
<input type="checkbox"/>	A.M.N.	R&S	ENV4200	EC 3558	2022-10-11
<input checked="" type="checkbox"/>	Attenuator	Huaxiang	TS5-10dB-6G-B	21062303	2022-04-25
<input checked="" type="checkbox"/>	Shielded room	Zhongyu	-	EC 2838	2022-01-12
Radiated Emission					
Used	Equipment	Manufacturer	Type	Internal no.	Due date
<input checked="" type="checkbox"/>	Test Receiver	R&S	ESIB 26	EC 3045	2022-09-16
<input checked="" type="checkbox"/>	Test Receiver	Keysight	N9030B	EC 6078	2022-06-10
<input checked="" type="checkbox"/>	Bilog Antenna	TESEQ	CBL 6112D	EC 4206	2022-09-25
<input checked="" type="checkbox"/>	Horn antenna	R&S	HF 906	EC 3049	2022-01-17
<input checked="" type="checkbox"/>	Horn antenna	ETS	3117	EC 4792-1	2022-03-15
<input checked="" type="checkbox"/>	Horn antenna	ETS	3116C	EC 5955	2022-05-21
<input checked="" type="checkbox"/>	Horn antenna	TOYO	HAP18-26W	EC 4792-3	2022-07-09
<input checked="" type="checkbox"/>	Pre-amplifier	R&S	Pre-amp 18	EC5262	2022-06-11
<input checked="" type="checkbox"/>	Semi-anechoic chamber	Albatross project	-	EC 3048	2022-07-14
RF test					
Used	Equipment	Manufacturer	Type	Internal no.	Due date
<input checked="" type="checkbox"/>	PXA Signal Analyzer	Keysight	N9030A	EC 5338	2022-03-16
<input checked="" type="checkbox"/>	PXA Signal Analyzer	Keysight	N9030B	EC 6078	2022-06-10
<input checked="" type="checkbox"/>	Power sensor	Agilent	U2021XA	EC 5338-1	2022-03-16
<input checked="" type="checkbox"/>	Vector Signal Generator	Agilent	N5182B	EC 5175	2022-03-16
<input checked="" type="checkbox"/>	MXG Analog Signal Generator	Agilent	N5181A	EC 5338-2	2022-03-16
<input checked="" type="checkbox"/>	Test Receiver	R&S	ESCI 7	EC 4501	2022-09-16
<input type="checkbox"/>	Universal Radio Communication Tester	R&S	CMW500	EC5944	2022-12-09
<input type="checkbox"/>	Universal Radio Communication Tester	R&S	CMW500	Ec6209	2022-12-30
<input checked="" type="checkbox"/>	Signal generator	Agilent	N5182A	Ec6172	2022-08-21
<input checked="" type="checkbox"/>	Signal generator	Agilent	N5181A	Ec6171	2022-08-21
<input checked="" type="checkbox"/>	Climate chamber	GWS	MT3065	EC 6021	2022-03-05
Additional instrument					
Used	Equipment	Manufacturer	Type	Internal no.	Due date
<input checked="" type="checkbox"/>	Therom-Hygrograph	ZJ1-2A	S.M.I.F.	EC 3783	2022-03-03
<input checked="" type="checkbox"/>	Pressure meter	YM3	Shanghai Mengde	EC 4620	2022-09-09

2.7 Measurement uncertainty

The measurement uncertainty represents an expanded uncertainty expressed at approximately the 95% confidence level using a coverage factor of k=2.

Test item	Measurement uncertainty
Maximum peak output power	$\pm 0.74\text{dB}$
26 dB Bandwidth & 99% Occupied Bandwidth	
Minimum 6dB Bandwidth	
Power spectral density	
Radiated Emissions in restricted frequency bands below 1GHz	$\pm 4.90\text{dB}$
Radiated Emissions in restricted frequency bands above 1GHz	$\pm 5.02\text{dB}$
Emission outside the frequency band	$\pm 2.89\text{dB}$
Power line conducted emission	$\pm 3.19\text{dB}$

TEST REPORT**3 26 dB Bandwidth & 99% Occupied Bandwidth****Test result: Pass****3.1 Limit**

None

3.2 Measurement Procedure

The EUT was tested according to test procedure of "KDB789033 D02 General UNII Test Procedures New Rules"

26 dB Bandwidth

- a) Set RBW = approximately 1% of the emission bandwidth.
- b) Set the VBW > RBW.
- c) Detector = Peak.
- d) Trace mode = max hold.
- e) Measure the maximum width of the emission that is 26 dB down from the maximum of the emission. Compare this with the RBW setting of the analyzer. Readjust RBW and repeat measurement as needed until the RBW/EBW ratio is approximately 1%.

99% Occupied Bandwidth

The following procedure shall be used for measuring (99 %) power bandwidth:

1. Set center frequency to the nominal EUT channel center frequency.
2. Set span = 1.5 times to 5.0 times the OBW.
3. Set RBW = 1 % to 5 % of the OBW
4. Set VBW $\geq 3 \cdot$ RBW
5. Video averaging is not permitted. Where practical, a sample detection and single sweep mode shall be used. Otherwise, peak detection and max hold mode (until the trace stabilizes) shall be used.
6. Use the 99 % power bandwidth function of the instrument (if available).
7. If the instrument does not have a 99 % power bandwidth function, the trace data points are recovered and directly summed in power units. The recovered amplitude data points, beginning at the lowest frequency, are placed in a running sum until 0.5 % of the total is reached; that frequency is recorded as the lower frequency. The process is repeated until 99.5 % of the total is reached; that frequency is recorded as the upper frequency. The 99% occupied bandwidth is the difference between these two frequencies.

3.3 Test Configuration

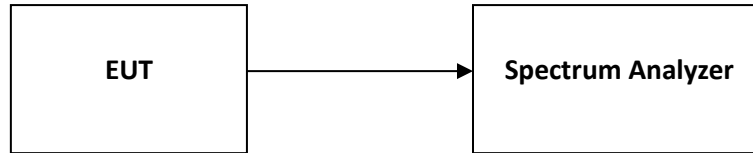

3.4 The results of 26 dB Bandwidth & 99% Occupied Bandwidth

Please refer to Appendix A

TEST REPORT

4 Minimum 6dB Bandwidth

Test result: Pass

4.1 Limit

For systems using digital modulation techniques that may operate in the 5725 - 5850 MHz band, the minimum 6 dB bandwidth shall be at least 500 kHz.

4.2 Measurement Procedure

The EUT was tested according to test procedure of “KDB789033 D02 General UNII Test Procedures New Rules”

- a) Set RBW = 100 kHz.
- b) Set the video bandwidth (VBW) $\geq 3 \times$ RBW.
- c) Detector = Peak.
- d) Trace mode = max hold.
- e) Sweep = auto couple.
- f) Allow the trace to stabilize.
- g) Measure the maximum width of the emission that is constrained by the frequencies associated with the two outermost amplitude points (upper and lower frequencies) that are attenuated by 6 dB relative to the maximum level measured in the fundamental emission.

Note: The automatic bandwidth measurement capability of a spectrum analyzer or EMI receiver may be employed if it implements the functionality described above.

4.3 Test Configuration

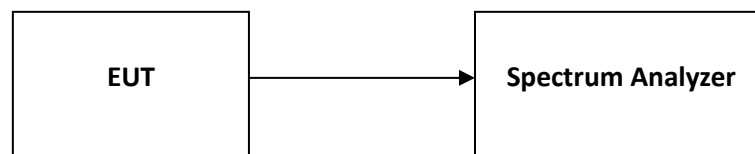

4.4 The results of Minimum 6dB Bandwidth

Please refer to Appendix A

5 Maximum conducted output power and e.i.r.p.

Test result: Pass

5.1 Limit

For an outdoor access point operating in the band 5.15-5.25GHz, the maximum conducted output power over the frequency band of operation shall not exceed 1W provided the maximum antenna gain does not exceed 6dBi.

The maximum e.i.r.p. at any elevation angle above 30 degrees from the horizon must not exceed 125mW (21 dBm).

For an indoor access point operating in the band 5.15-5.25GHz, the maximum conducted output power over the frequency band of operation shall not exceed 1 W provided the maximum antenna gain does not exceed 6dBi.

For fixed point-to-point access points operating in the band 5.15-5.25GHz, the maximum conducted output power over the frequency band of operation shall not exceed 1W.

For client devices in the 5.15-5.25GHz band, the maximum conducted output power over the frequency band of operation shall not exceed 250mW provided the maximum antenna gain does not exceed 6dBi. (FCC Limit)

For the 5.25-5.35GHz and 5.47-5.725GHz bands, the maximum conducted output power over the frequency bands of operation shall not exceed the lesser of 250mW or 11dBm + 10logB, where B is the 26dB emission bandwidth in megahertz. (FCC limit)

For the band 5.725-5.85GHz, the maximum conducted output power over the frequency band of operation shall not exceed 1W. (FCC limit)

For Frequency Band 5150-5250 MHz, the maximum e.i.r.p. shall not exceed 200 mW or 10 + 10 log10B, dBm, whichever power is less. B is the 99% emission bandwidth in megahertz. (IC limit)

For the 5.25-5.35 GHz and 5.47-5.725 GHz bands, the maximum conducted output power over the frequency bands of operation shall not exceed the lesser of 250 mW or 11 dBm + 10 log B, where B is the 99% emission bandwidth in megahertz. (IC limit)

For the 5.25-5.35 GHz and 5.47-5.725 GHz bands, the maximum e.i.r.p. shall not exceed 1.0 W or 17 + 10 log10B, dBm, whichever is less. B is the 99% emission bandwidth in megahertz. (IC limit)

For the band 5.725-5.85 GHz, the maximum conducted output power over the frequency band of operation shall not exceed 1 W. (IC limit)

If transmitting antennas of directional gain greater than 6dBi are used, the maximum conducted output power shall be reduced by the amount in dB that the directional gain of the antenna exceeds 6dBi.

TEST REPORT

5.2 Measurement Procedure

The EUT was tested according to test procedure of “KDB789033 D02 General UNII Test Procedures New Rules”

- (i) Set span to encompass the entire emission bandwidth (EBW) (or, alternatively, the entire 99% occupied bandwidth) of the signal.
- (ii) Set RBW = 1 MHz.
- (iii) Set VBW ≥ 3 MHz.
- (iv) Number of points in sweep $\geq 2 \times \text{span} / \text{RBW}$. (This ensures that bin-to-bin spacing is $\leq \text{RBW}/2$, so that narrowband signals are not lost between frequency bins.)
- (v) Sweep time = auto.
- (vi) Detector = power averaging (rms), if available. Otherwise, use sample detector mode.
- (vii) If transmit duty cycle < 98%, use a video trigger with the trigger level set to enable triggering only on full power pulses. Transmitter must operate at maximum power control level for the entire duration of every sweep. If the EUT transmits continuously (i.e., with no off intervals) or at duty cycle $\geq 98\%$, and if each transmission is entirely at the maximum power control level, then the trigger shall be set to “free run.”
- (viii) Trace average at least 100 traces in power averaging (rms) mode.
- (ix) Compute power by integrating the spectrum across the EBW (or, alternatively, the entire 99% occupied bandwidth) of the signal using the instrument’s band power measurement function with band limits set equal to the EBW (or occupied bandwidth) band edges. If the instrument does not have a band power function, sum the spectrum levels (in power units) at 1 MHz intervals extending across the EBW (or, alternatively, the entire 99% occupied bandwidth) of the spectrum.

5.3 Test Configuration

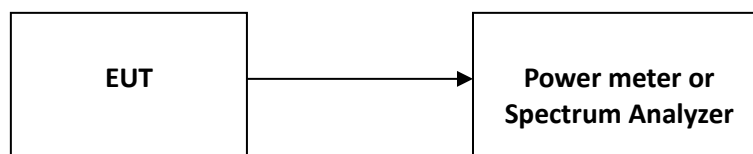

5.4 Test Results of Maximum conducted output power and e.i.r.p.

Please refer to Appendix A

TEST REPORT**6 Power spectrum density****Test result: Pass****6.1 Limit**

For an outdoor access point operating in the band 5.15-5.25GHz, the maximum power spectral density shall not exceed 17dBm in any 1 megahertz band.

For an indoor access point operating in the band 5.15-5.25GHz, the maximum power spectral density shall not exceed 17 dBm in any 1 megahertz band.

For client devices in the 5.15-5.25GHz band, the maximum power spectral density shall not exceed 11 dBm in any 1 megahertz band. (FCC limit)

For the 5.25-5.35 GHz and 5.47-5.725GHz bands, the maximum power spectral density shall not exceed 11 dBm in any 1 megahertz band. (FCC limit)

For the band 5.725-5.85GHz, the maximum power spectral density shall not exceed 30dBm in any 500kHz band. (FCC limit)

For the 5.15-5.25GHz band, the e.i.r.p. spectral density shall not exceed 10 dBm in any 1.0 MHz band. (IC limit)

For the 5.25-5.35 GHz and 5.47-5.725 GHz bands, the maximum power spectral density shall not exceed 11 dBm in any 1 megahertz band. (IC limit)

For the 5.725-5.85GHz band, the maximum power spectral density shall not exceed 30 dBm in any 500-kHz band. (IC limit)

If the transmitting antenna of directional gain greater than 6dBi is used, the power shall be reduced by the amount in dB that the directional gain of the antenna exceeds 6dBi. If there have a beam forming type, the limit should be the less of original and original + (6 - antenna gain - beamforming gain).

6.2 Measurement Procedure

The EUT was tested according to test procedure of “KDB789033 D02 General UNII Test Procedures New Rules”

1. Create an average power spectrum for the EUT operating mode being tested by following the instructions in II.E.2. for measuring maximum conducted output power using a spectrum analyzer or EMI receiver: select the appropriate test method (SA-1, SA-2, SA-3, or alternatives to each) and apply it up to, but not including, the step labeled, “Compute power....” (This procedure is required even if the maximum conducted output power measurement was performed using a power meter, method PM.)
2. Use the peak search function on the instrument to find the peak of the spectrum and record its value.
3. Make the following adjustments to the peak value of the spectrum, if applicable:
 - a) If Method SA-2 or SA-2 Alternative was used, add $10 \log (1/x)$, where x is the duty cycle, to the peak of the spectrum.
 - b) If Method SA-3 Alternative was used and the linear mode was used in step II.E.2.g)(viii), add 1 dB to the final result to compensate for the difference between linear averaging and power averaging.
4. The result is the Maximum PSD over 1 MHz reference bandwidth.
5. For devices operating in the bands 5.15 5.25 GHz, 5.25 5.35 GHz, and 5.47 5.725 GHz, the above procedures make use of 1 MHz RBW to satisfy directly the 1 MHz reference bandwidth specified in Section 15.407(a)(5). For devices operating in the band 5.725 5.85 GHz, the rules specify a measurement bandwidth of 500 kHz. Many spectrum analyzers do not have 500 kHz RBW, thus a narrower RBW may need to be used. The rules permit the use of a RBWs less than 1 MHz, or 500 kHz, “provided that the measured power is integrated over the full reference bandwidth” to show the total power over the specified measurement bandwidth (i.e., 1 MHz, or 500 kHz). If measurements are performed using a reduced resolution bandwidth (< 1 MHz, or < 500 kHz) and integrated over 1 MHz, or 500 kHz bandwidth, the following adjustments to the procedures apply:
 - a) Set $RBW \geq 1/T$, where T is defined in II.B.1.a).
 - b) Set $VBW \geq 3 RBW$.
 - c) If measurement bandwidth of Maximum PSD is specified in 500 kHz, add $10 \log (500 \text{ kHz}/RBW)$ to the measured result, whereas RBW (<500 kHz) is the reduced resolution bandwidth of the spectrum analyzer set during measurement.
 - d) If measurement bandwidth of Maximum PSD is specified in 1 MHz, add $10 \log (1\text{MHz}/RBW)$ to the measured result, whereas RBW (< 1 MHz) is the reduced resolution bandwidth of spectrum analyzer set during measurement.
 - e) Care must be taken to ensure that the measurements are performed during a period of continuous transmission or are corrected upward for duty cycle.

Note: As a practical matter, it is recommended to use reduced RBW of 100 kHz for steps 5.c) and 5.d) above, since RBW=100 KHZ is available on nearly all spectrum analyzers.

6.3 Test Configuration

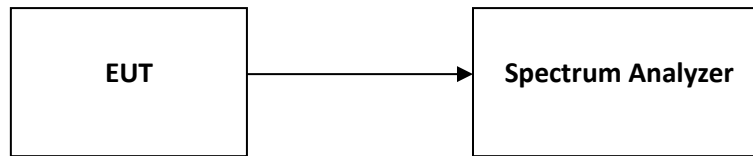

6.4 Test Results of Power spectrum density

Please refer to Appendix A

TEST REPORT

7 Radiated Emissions

Test result: Pass

7.1 Limit

The radiated emissions which fall in the restricted bands, and the radiated emissions below 1GHz, must comply with the radiated emission limits specified showed as below:

Frequencies (MHz)	Field Strength (microvolts/meter)	Measurement Distance (meters)
0.009 ~ 0.490	2400/F(kHz)	300
0.490 ~ 1.705	24000/F(kHz)	30
1.705 ~ 30.0	30	30
30 ~ 88	100	3
88 ~ 216	150	3
216 ~ 960	200	3
Above 960	500	3

The radiated emissions which fall outside the restrict bands, should comply with the EIRP limit as below:

For transmitters operating in the 5.15 - 5.25 / 5.25 - 5.35 / 5.47 - 5.725GHz band:

Frequency (MHz)	EIRP Limit (dBm)	Equivalent Field Strength (3m) (dBμV/m)
<5150	-27	68.20
>5350		
<5470		
>5725		

For transmitters operating in the 5.725 - 5.85GHz band:

Frequency (MHz)	EIRP Limit (dBm/MHz)	Equivalent Field Strength (3m) (dBμV/m)
<5650	-27	68.20
5650 ~ 5700	-27 ~ 10	68.20 ~ 105.20
5700 ~ 5720	10 ~ 15.6	105.20 ~ 110.80
5720 ~ 5725	15.6 ~ 27	110.80 ~ 122.20
5850 ~ 5855	27 ~ 15.6	122.20 ~ 110.80
5855 ~ 5875	15.6 ~ 10	110.80 ~ 105.20
5875 ~ 5925	10 ~ -27	105.20 ~ 68.20
>5925	-27	68.20

TEST REPORT**7.2 Measurement Procedure****For Radiated emission below 30MHz:**

- a) The EUT was placed on the top of a rotating table 0.8 meters above the ground at a 3 meters chamber room. The table was rotated 360 degrees to determine the position of the highest radiation.
- b) The EUT was set 3 meters away from the interference-receiving antenna, which was mounted on the top of a variable-height antenna tower.
- c) Both X and Y axes of the antenna are set to make the measurement.
- d) For each suspected emission, the EUT was arranged to its worst case and the rotatable table was turned from 0 degrees to 360 degrees to find the maximum reading.
- e) The test-receiver system was set to peak or quasi-peak detect function and specified bandwidth with maximum hold mode.

NOTE:

1. The resolution bandwidth and video bandwidth of test receiver/spectrum analyzer is 9kHz at frequency below 30MHz.

For Radiated emission above 30MHz:

- a) The EUT was placed on the top of a rotating table 0.8 meters (for 30MHz ~ 1GHz) / 1.5 meters (for above 1GHz) above the ground at 3 meters chamber room for test. The table was rotated 360 degrees to determine the position of the highest radiation.
- b) The EUT was set 3 meters away from the interference-receiving antenna, which was mounted on the top of a variable-height antenna tower.
- c) The height of antenna is varied from one meter to four meters above the ground to determine the maximum value of the field strength. Both horizontal and vertical polarizations of the antenna are set to make the measurement.
- d) For each suspected emission, the EUT was arranged to its worst case and then the antenna was tuned to heights from 1 meter to 4 meters and the rotatable table was turned from 0 degrees to 360 degrees to find the maximum reading.
- e) The test-receiver system was set to peak or quasi-peak detect function and specified bandwidth with maximum hold mode when the test frequency is below 1 GHz.
- f) The test-receiver system was set to peak and average detect function and specified bandwidth with maximum hold mode when the test frequency is above 1 GHz. If the peak reading value also meets average limit, measurement with the average detector is unnecessary.

Note:

1. The resolution bandwidth of test receiver/spectrum analyzer is 120kHz for peak or quasi-peak detection at frequency below 1GHz.
2. The resolution bandwidth of test receiver/spectrum analyzer is 1 MHz at frequency above 1GHz for peak detection above 1GHz.
3. The resolution bandwidth of test receiver/spectrum analyzer is 1 MHz and the video bandwidth is $\geq 1/T$ (Duty cycle < 98%) or 3 x RBW (Duty cycle $\geq 98\%$) for average detection (AV) at frequency above 1GHz.
4. All modes of operation were investigated and the worst-case emissions are reported.

TEST REPORT

7.3 Test Configuration

For Radiated emission below 30MHz:

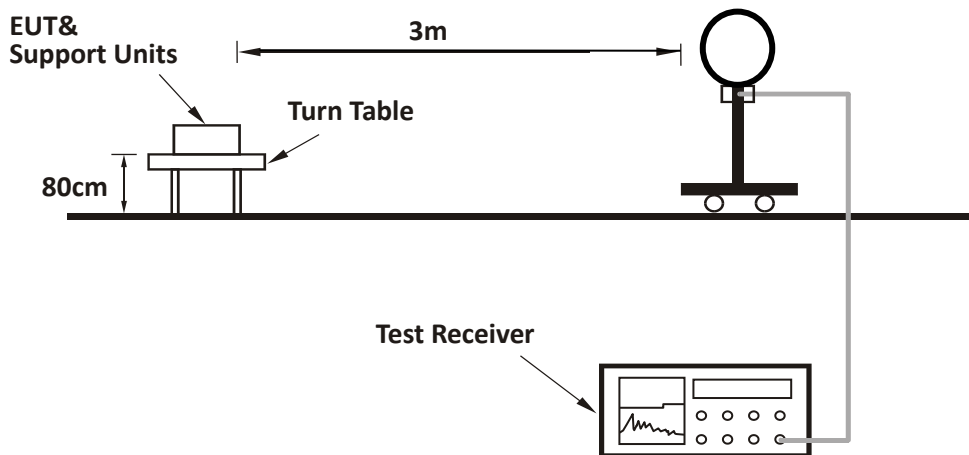

For Radiated emission 30MHz to 1GHz:

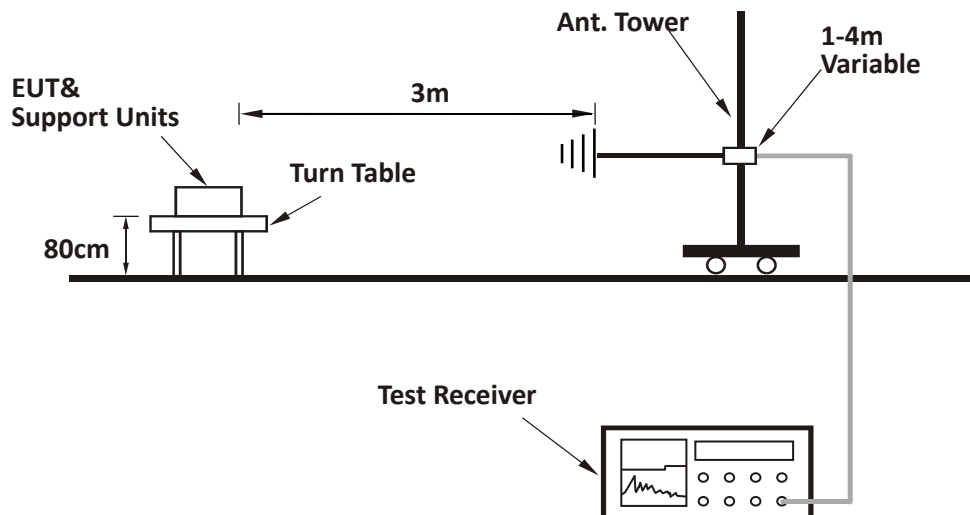

TEST REPORT

For Radiated emission above 1GHz:

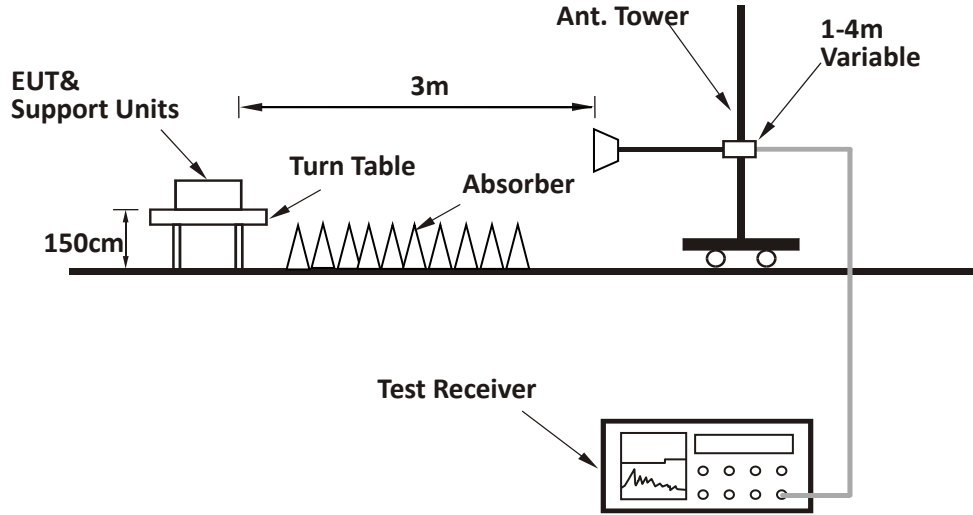

TEST REPORT

7.4 Test Results of Radiated Emissions

The low frequency, which started from 9 kHz to 30MHz, was pre-scanned and the result which was 20dB lower than the limit line per 15.31(o) was not reported.

Horizontal

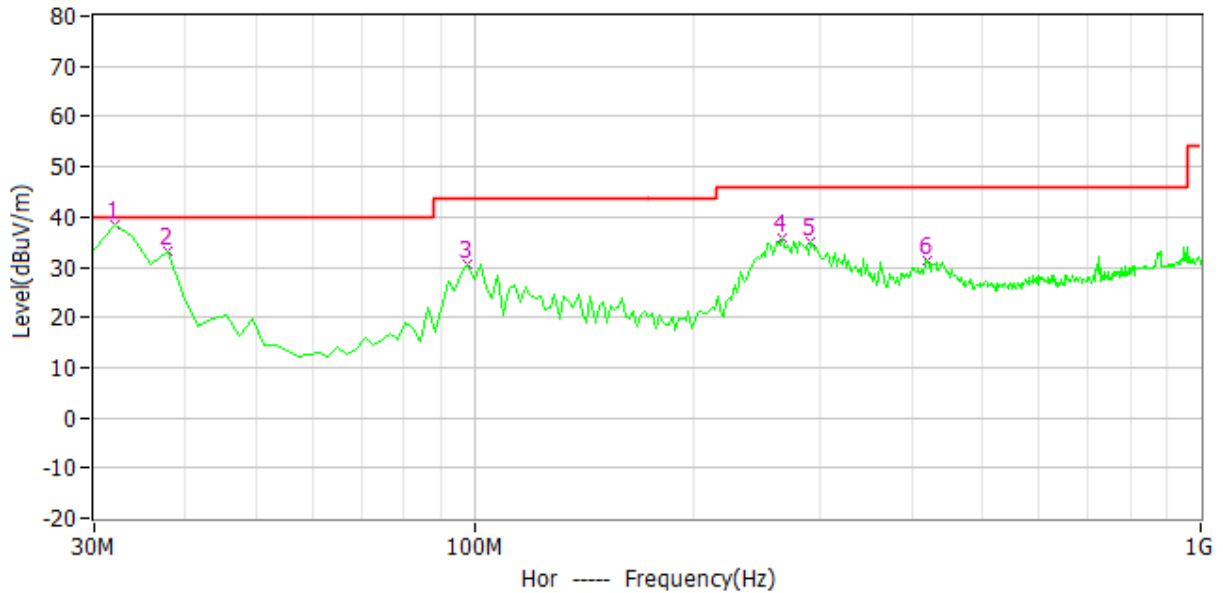

Vertical

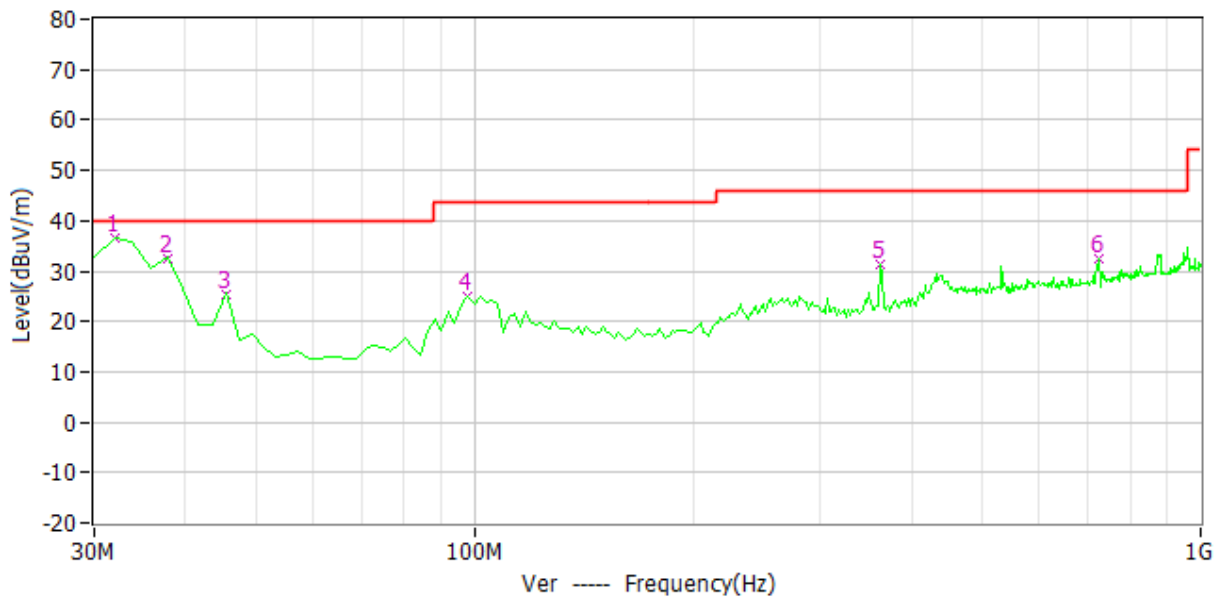

TEST REPORT

Test data below 1GHz

Antenna	Frequency (MHz)	Corrected Reading (dBuV/m)	Correct Factor (dB/m)	Limit (dBuV/m)	Margin (dB)	Detector
H	31.944	38.4	20.2	40.0	1.8	PK
H	37.776	33.3	16.5	40.0	6.7	PK
H	98.036	30.6	12.3	43.5	12.9	PK
H	265.210	35.7	15.6	46.0	10.3	PK
H	290.481	35.0	15.5	46.0	11.0	PK
H	420.721	31.3	18.8	46.0	14.7	PK
V	31.944	36.6	20.2	40.0	3.4	PK
V	37.776	32.6	16.5	40.0	7.4	PK
V	45.551	25.5	12.3	40.0	14.5	PK
V	98.036	25.1	12.3	43.5	18.4	PK
V	362.405	31.3	17.4	46.0	14.7	PK
V	725.912	32.5	22.9	46.0	13.5	PK

TEST REPORT

Test result above 1GHz:

The emission was conducted from 1GHz to 40GHz

U-NII-1 Band:

802.11a

Channel	Polarity	Frequency (MHz)	Correct Factor (dB/m)	Corrected Reading (dBuV/m)	Limit (dBuV/m)	Margin (dB)	Detector
L	H	5150.00	3.1	62.7	74.00	11.3	PK
	H	5150.00	3.1	52.3	54.00	1.7	AV
	V	5150.00	3.1	55.5	74.00	18.5	PK
	V	5150.00	3.1	50.5	54.00	3.5	AV
	H	10360.00	13.2	49.9	68.20	18.3	PK
	V	10360.00	13.2	50.3	68.20	17.9	PK
M	H	10440.00	13.2	50.4	68.20	17.8	PK
	H	15660.00	15.8	55.6	68.20	12.6	PK
	V	10440.00	13.2	50.4	68.20	17.8	PK
	V	15660.00	15.8	51.8	68.20	16.4	PK
H	H	10480.00	13.2	40.1	68.20	28.1	PK
	H	15720.00	16.2	50.6	68.20	17.6	PK
	V	10480.00	13.2	54.5	68.20	13.7	PK
	V	15720.00	16.2	53.8	68.20	14.4	PK

802.11n20

Channel	Polarity	Frequency (MHz)	Correct Factor (dB/m)	Corrected Reading (dBuV/m)	Limit (dBuV/m)	Margin (dB)	Detector
L	H	5150.00	3.1	59.0	74.00	15.0	PK
	H	5150.00	3.1	49.7	54.00	4.3	AV
	V	5150.00	3.1	53.4	74.00	20.6	PK
	H	10360.00	13.2	52.0	68.20	16.2	PK
	V	10360.00	13.2	53.7	68.20	14.5	PK
M	H	10440.00	13.2	50.4	68.20	17.8	PK
	V	10440.00	13.2	53.1	68.20	15.1	PK

TEST REPORT

H	H	10480.00	13.2	53.1	68.20	15.1	PK
	V	10480.00	13.2	50.4	68.20	17.8	PK

802.11n40

Channel	Polarity	Frequency (MHz)	Correct Factor (dB/m)	Corrected Reading (dBuV/m)	Limit (dBuV/m)	Margin (dB)	Detector
L	H	5150.00	3.1	64.4	74.00	9.6	PK
	H	5150.00	3.1	50.2	54.00	3.8	AV
	V	5150.00	3.1	61.2	74.00	12.8	PK
	V	5150.00	3.1	48.6	54.00	5.4	AV
	H	10380.00	13.2	51.0	68.20	17.2	PK
	V	10380.00	13.2	51.6	68.20	16.6	PK
H	H	10460.00	13.2	51.8	68.20	16.4	PK
	V	10460.00	13.2	52.5	68.20	15.7	PK

U-NII-2A Band:

802.11a

Channel	Polarity	Frequency (MHz)	Correct Factor (dB/m)	Corrected Reading (dBuV/m)	Limit (dBuV/m)	Margin (dB)	Detector
L	H	10520.00	13.1	49.0	68.20	19.2	PK
	H	15780.00	16.4	51.0	68.20	17.2	PK
	V	10520.00	13.1	54.4	68.20	13.8	PK
	V	15780.00	16.4	52.5	68.20	15.7	PK
M	H	10600.00	13.1	50.3	68.20	17.9	PK
	H	15900.00	16.8	51.8	68.20	16.4	PK
	V	10600.00	13.1	53.5	68.20	14.7	PK
	V	15900.00	16.8	51.5	68.20	16.7	PK
H	H	5350.00	2.9	60.3	74.00	13.7	PK
	H	5350.00	2.9	50.2	54.00	3.8	AV
	V	5350.00	2.9	53.8	74.00	20.2	PK
	H	10640.00	13.1	50.8	68.20	17.4	PK

TEST REPORT

	V	10640.00	13.1	54.1	68.20	14.1	PK
--	---	----------	------	------	-------	------	----

802.11n20

Channel	Polarity	Frequency (MHz)	Correct Factor (dB/m)	Corrected Reading (dBuV/m)	Limit (dBuV/m)	Margin (dB)	Detector
L	H	10520.00	13.1	51.4	68.20	16.8	PK
	H	15780.00	16.4	55.9	68.20	12.3	PK
	V	10520.00	13.1	55.3	68.20	12.9	PK
	V	15780.00	16.4	60.6	68.20	7.6	PK
M	H	10600.00	13.1	53.9	68.20	14.3	PK
	H	15900.00	16.8	53.7	68.20	14.5	PK
	V	10600.00	13.1	54.8	68.20	13.4	PK
	V	15900.00	16.8	59.5	68.20	8.7	PK
H	H	5350.00	2.9	60.7	74.00	13.3	PK
	H	5350.00	2.9	49.6	54.00	4.4	AV
	V	5350.00	2.9	56.4	74.00	17.6	PK
	V	5350.00	2.9	43.5	54.00	10.5	AV
	H	10640.00	13.1	52.4	68.20	15.8	PK
	V	10640.00	13.1	56.4	68.20	11.8	PK

802.11n40

Channel	Polarity	Frequency (MHz)	Correct Factor (dB/m)	Corrected Reading (dBuV/m)	Limit (dBuV/m)	Margin (dB)	Detector
L	H	10540.00	13.1	52.3	68.20	15.9	PK
	H	15810.00	16.4	56.8	68.20	11.4	PK
	V	10540.00	13.1	55.9	68.20	12.3	PK
	V	15810.00	16.4	61.2	68.20	7.0	PK
H	H	5350.00	2.9	65.9	74.00	8.1	PK
	H	5350.00	2.9	52.3	54.00	1.7	AV
	V	5350.00	2.9	62.5	74.00	11.5	PK
	V	5350.00	2.9	50.1	54.00	3.9	AV

TEST REPORT

	H	10620.00	13.1	52.9	68.20	15.3	PK
	V	10620.00	13.1	57.3	68.20	10.9	PK

U-NII-2C Band:
802.11a

Channel	Polarity	Frequency	Correct Factor	Corrected Reading	Limit	Margin	Detector
		(MHz)	(dB/m)	(dBuV/m)	(dBuV/m)	(dB)	
L	H	5460.00	2.8	59.0	74.00	15.0	PK
	H	5460.00	2.8	49.5	54.00	4.5	AV
	V	5460.00	2.8	53.1	74.00	20.9	PK
	H	16500.00	13.1	50.8	68.20	17.4	PK
	H	11000.00	18.3	50.2	68.20	18.0	PK
	V	16500.00	13.1	52.3	68.20	15.9	PK
	V	11000.00	18.3	50.7	68.20	17.5	PK
M	H	11160.00	14.0	51.8	68.20	16.4	PK
	H	16740.00	19.2	52.1	68.20	16.1	PK
	V	11160.00	14.0	57.4	68.20	10.8	PK
	V	16740.00	19.2	52.1	68.20	16.1	PK
	H	11400.00	13.8	52.4	68.20	15.8	PK
	H	17100.00	20.1	50.9	68.20	17.3	PK
	V	11400.00	13.8	54.7	68.20	13.5	PK
	V	17100.00	20.1	52.6	68.20	15.6	PK

802.11n20

Channel	Polarity	Frequency	Correct Factor	Corrected Reading	Limit	Margin	Detector
		(MHz)	(dB/m)	(dBuV/m)	(dBuV/m)	(dB)	
L	H	5460.00	2.8	59.5	74.00	14.5	PK
	H	5460.00	2.8	48.8	54.00	5.2	AV
	V	5460.00	2.8	53.5	74.00	20.5	PK
	H	11000.00	13.1	50.6	68.20	17.6	PK
	H	16500.00	18.3	51.5	68.20	16.7	PK

TEST REPORT

	V	11000.00	13.1	50.1	68.20	18.1	PK
	V	16500.00	18.3	51.6	68.20	16.6	PK
M	H	11160.00	13.4	60.8	68.20	7.4	PK
	H	16740.00	19.2	54.3	68.20	13.9	PK
	V	11160.00	13.4	63.5	68.20	4.7	PK
	V	16740.00	19.2	53.9	68.20	14.3	PK
H	H	11400.00	13.8	59.4	74.00	14.6	PK
	V	11400.00	20.1	51.2	74.00	22.8	PK
	H	17100.00	13.8	59.4	68.20	8.8	PK
	V	17100.00	20.1	52.1	68.20	16.1	PK

802.11n40

Channel	Polarity	Frequency (MHz)	Correct Factor (dB/m)	Corrected Reading (dBuV/m)	Limit (dBuV/m)	Margin (dB)	Detector
L	H	5460.00	2.8	63.3	74.00	10.7	PK
	H	5460.00	2.8	51.6	54.00	2.4	AV
	V	5460.00	2.8	56.8	74.00	17.2	PK
	V	5460.00	2.8	49.2	54.00	4.8	AV
	H	16530.00	13.4	61.9	68.20	6.3	PK
	V	16530.00	18.3	52.8	68.20	15.4	PK
M	H	11100.00	13.4	61.6	68.20	6.6	PK
	H	16650.00	18.3	52.1	68.20	16.1	PK
	V	11100.00	13.4	62.1	68.20	6.1	PK
	V	16650.00	18.3	51.9	68.20	16.3	PK
	H	17010.00	13.8	60.3	68.20	7.9	PK
	V	17010.00	20.1	53.1	68.20	15.1	PK

TEST REPORT

U-NII-3 Band:
802.11a

Channel	Polarity	Frequency (MHz)	Correct Factor (dB/m)	Corrected Reading (dBuV/m)	Limit (dBuV/m)	Margin (dB)	Detector
L	H	11490.00	13.8	50.15	68.20	18.05	PK
	H	17235.00	14.2	53.66	68.20	14.54	PK
	V	11490.00	13.8	55.53	68.20	12.67	PK
	V	17235.00	14.2	58.45	68.20	9.75	PK
M	H	11570.00	13.9	51.36	68.20	16.84	PK
	H	17355.00	14.3	55.16	68.20	13.04	PK
	V	11570.00	13.9	56.05	68.20	12.15	PK
	V	17355.00	14.3	57.95	68.20	10.25	PK
H	H	11650.00	14.0	52.22	68.20	15.98	PK
	H	17475.00	14.5	55.65	68.20	12.55	PK
	V	11650.00	14.0	53.66	68.20	14.54	PK
	V	17475.00	14.5	57.52	68.20	10.68	PK

802.11n20

Channel	Polarity	Frequency (MHz)	Correct Factor (dB/m)	Corrected Reading (dBuV/m)	Limit (dBuV/m)	Margin (dB)	Detector
L	H	11490.00	13.8	53.45	68.20	14.75	PK
	H	17235.00	14.2	56.73	68.20	11.47	PK
	V	11490.00	13.8	59.00	68.20	9.2	PK
	V	17235.00	14.2	62.16	68.20	6.04	PK
M	H	11570.00	13.9	55.11	68.20	13.09	PK
	H	17355.00	14.3	58.05	68.20	10.15	PK
	V	11570.00	13.9	61.22	68.20	6.98	PK
	V	17355.00	14.3	63.68	68.20	4.52	PK
H	H	11650.00	14.0	56.15	68.20	12.05	PK
	H	17475.00	14.5	58.95	68.20	9.25	PK

TEST REPORT

	V	11650.00	14.0	49.28	68.20	18.92	PK
	V	17475.00	14.5	61.84	68.20	6.36	PK

802.11n40

Channel	Polarity	Frequency (MHz)	Correct Factor (dB/m)	Corrected Reading (dBuV/m)	Limit (dBuV/m)	Margin (dB)	Detector
L	H	11510.00	13.9	52.45	68.20	15.75	PK
	H	17265.00	14.2	56.84	68.20	11.36	PK
	V	11510.00	13.9	53.18	68.20	15.02	PK
	V	17265.00	14.2	55.16	68.20	13.04	PK
H	H	11590.00	13.9	53.95	68.20	14.25	PK
	H	17385.00	14.3	54.07	68.20	14.13	PK
	V	11590.00	13.9	52.66	68.20	15.54	PK
	V	17385.00	14.3	56.15	68.20	12.05	PK

- Remark: 1. Correct Factor = Antenna Factor + Cable Loss (- Amplifier, for higher than 1GHz), the value was added to Original Receiver Reading by the software automatically.
 2. Corrected Reading = Original Receiver Reading + Correct Factor
 3. Margin = Limit - Corrected Reading
 4. If the PK Corrected Reading is lower than AV limit, the AV test can be elided.

Example: Assuming Antenna Factor = 30.20dB/m, Cable Loss = 2.00dB,
 Gain of Preamplifier = 32.00dB, Original Receiver Reading = 10.00dBuV,
 Limit = 40.00dBuV/m.
 Then Correct Factor = 30.20 + 2.00 – 32.00 = 0.20dB/m;
 Corrected Reading = 10dBuV + 0.20dB/m = 10.20dBuV/m;
 Margin = 40.00dBuV/m - 10.20dBuV/m = 29.80dB.

8 Power line conducted emission

Test result: Pass

8.1 Limit

Frequency of Emission (MHz)	Conducted Limit (dBuV)	
	QP	AV
0.15-0.5	66 to 56*	56 to 46 *
0.5-5	56	46
5-30	60	50

* Decreases with the logarithm of the frequency.

8.2 Test Configuration

8.3

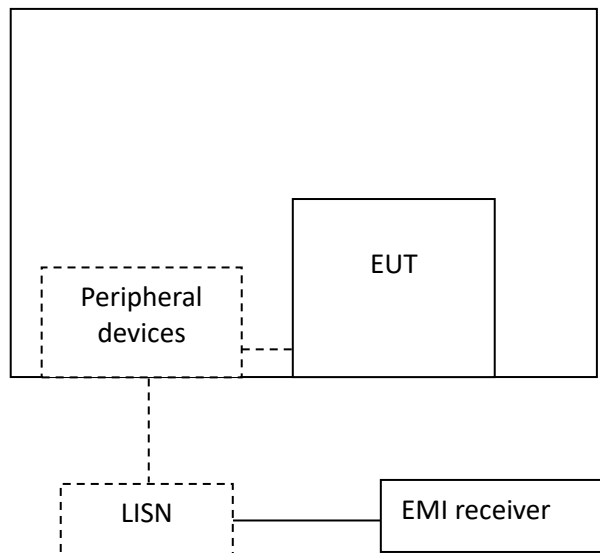

TEST REPORT**8.4 Measurement Procedure**

Measured levels of ac power-line conducted emission shall be the emission voltages from the voltage probe, where permitted, or across the 50 Ω LISN port (to which the EUT is connected), where permitted, terminated into a 50 Ω measuring instrument. All emission voltage and current measurements shall be made on each current-carrying conductor at the plug end of the EUT power cord by the use of mating plugs and receptacles on the LISN, if used. Equipment shall be tested with power cords that are normally supplied or recommended by the manufacturer and that have electrical and shielding characteristics that are the same as those cords normally supplied or recommended by the manufacturer. For those measurements using a LISN, the 50 Ω measuring port is terminated by a measuring instrument having 50 Ω input impedance. All other ports are terminated in 50 Ω loads.

Tabletop devices shall be placed on a platform of nominal size 1 m by 1.5 m, raised 80 cm above the reference ground plane. The vertical conducting plane or wall of an RF-shielded (screened) room shall be located 40 cm to the rear of the EUT. Floor-standing devices shall be placed either directly on the reference ground-plane or on insulating material as described in ANSI C63.4. All other surfaces of tabletop or floor-standing EUTs shall be at least 80 cm from any other grounded conducting surface, including the case or cases of one or more LISNs.

The bandwidth of the test receiver is set at 9 kHz.

TEST REPORT

8.5 Test Results of Power line conducted emission

Test Voltage: 120V/60Hz

L line

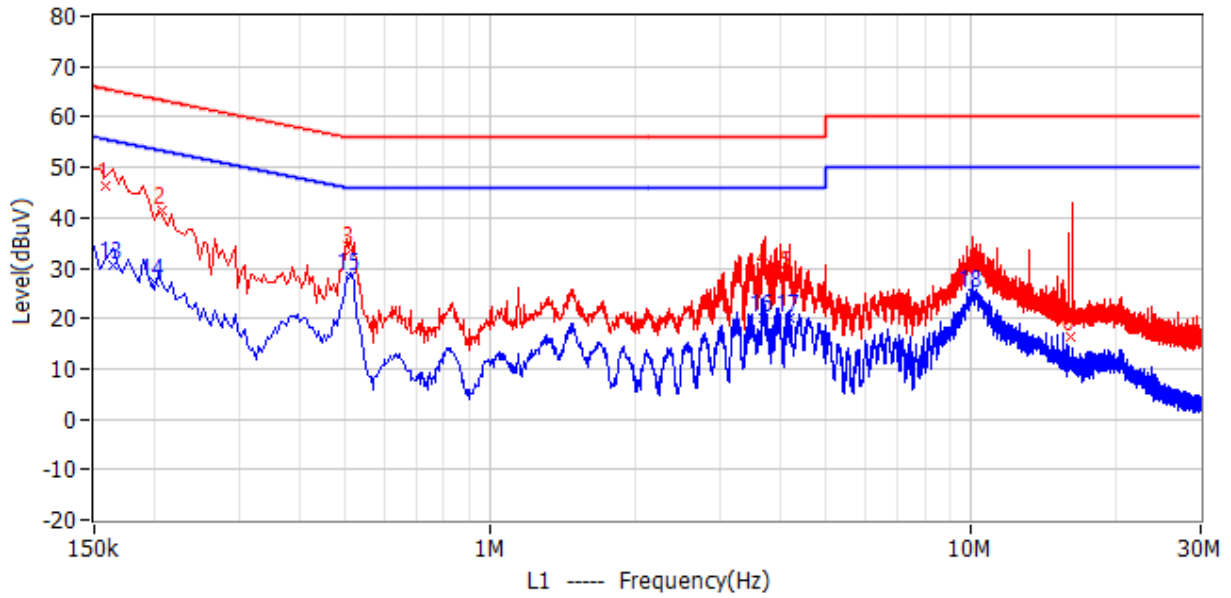

N line

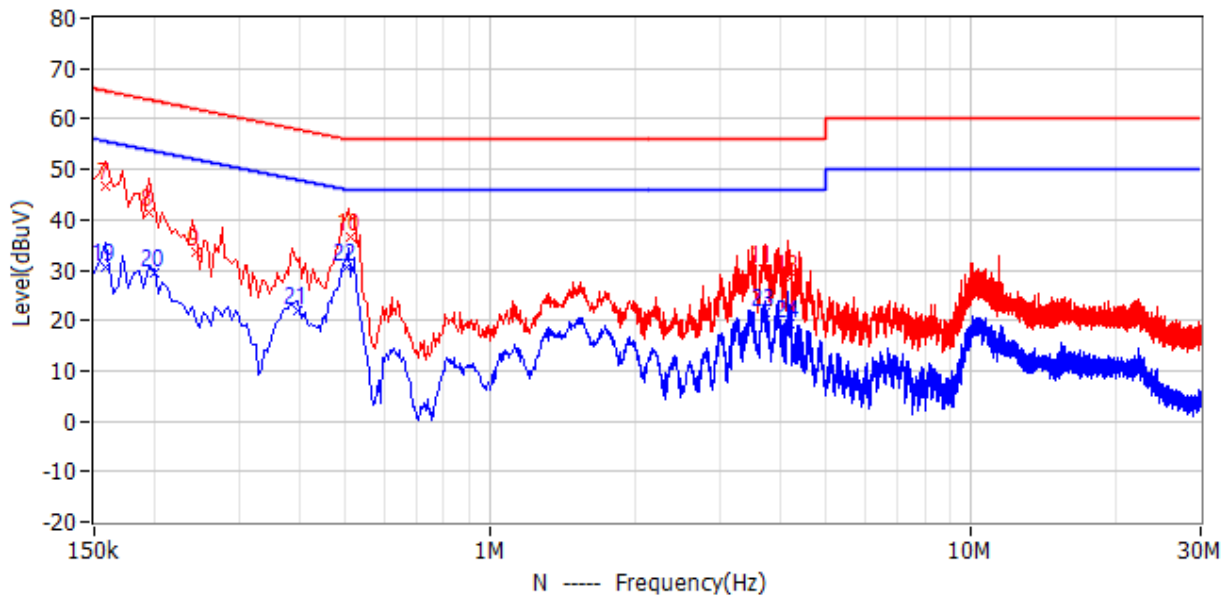

TEST REPORT

Test Data:

No.	Frequency	Limit dBuV	Level dBuV	Margin dB	Reading dBuV	Factor dB	Detector	Phase
1	159.000kHz	65.5	46.4	19.1	36.0	10.4	QP	L1
2	208.500kHz	63.3	41.3	22.0	30.9	10.4	QP	L1
3	510.000kHz	56.0	33.5	22.5	23.2	10.3	QP	L1
4	3.719MHz	56.0	29.3	26.7	18.9	10.4	QP	L1
5	4.164MHz	56.0	28.8	27.2	18.4	10.4	QP	L1
6	16.103MHz	60.0	16.3	43.7	5.3	11.0	QP	L1
7	159.000kHz	65.5	46.8	18.8	36.4	10.4	QP	N
8	195.000kHz	63.8	41.5	22.3	31.1	10.4	QP	N
9	244.500kHz	61.9	33.5	28.5	23.1	10.4	QP	N
10	510.000kHz	56.0	36.4	19.6	26.1	10.3	QP	N
11	3.701MHz	56.0	30.2	25.8	19.8	10.4	QP	N
12	4.196MHz	56.0	28.5	27.5	18.1	10.4	QP	N
13	163.500kHz	55.3	30.6	24.7	20.3	10.3	AV	L1
14	199.500kHz	53.6	27.3	26.3	16.9	10.4	AV	L1
15	510.000kHz	46.0	28.5	17.5	18.2	10.3	AV	L1
16	3.683MHz	46.0	19.9	26.1	9.5	10.4	AV	L1
17	4.182MHz	46.0	20.0	26.0	9.6	10.4	AV	L1
18	10.073MHz	50.0	24.8	25.2	13.9	10.9	AV	L1
19	159.000kHz	55.5	30.7	24.8	20.3	10.4	AV	N
20	199.500kHz	53.6	29.6	24.1	19.2	10.4	AV	N
21	397.500kHz	47.9	22.1	25.8	11.8	10.3	AV	N
22	501.000kHz	46.0	30.7	15.3	20.4	10.3	AV	N
23	3.719MHz	46.0	21.6	24.4	11.2	10.4	AV	N
24	4.178MHz	46.0	19.5	26.5	9.1	10.4	AV	N

- Remark: 1. Factor = LISN Factor + Cable Loss, the value was added to Original Receiver Reading by the software automatically.*
- 2. Level = Reading + Factor*
- 3. Margin = Limit - Level*
- 4. If the PK Corrected Reading is lower than AV limit, the AV test can be elided.*

9 Frequency Stability

Test result: Pass

9.1 Limit

The frequency stability shall be sufficient to ensure that an emission is maintained within the band of operation under all conditions of normal operation as specified in the user's manual.

9.2 Test Result

Frequency Error - Temperature Variation

Supply Voltage DC (V)	Temperature (°C)	Frequency Deviation (ppm)
		Channel (5180MHz)
3.3	-20	7.722008
	-10	0
	0	3.861004
	10	7.722008
	20	7.722008
	30	0
	40	3.861004
	50	3.861004

Frequency Error - Voltage Variation

Supply Voltage DC (V)	Temperature (°C)	Frequency Deviation (ppm)
		Channel (5180MHz)
2.97	20	3.861004
3.3		7.722008
3.63		3.861004

TEST REPORT

10 Antenna requirement

Requirement:

An intentional radiator shall be designed to ensure that no antenna other than that furnished by the responsible party shall be used with the device. The use of a permanently attached antenna or of an antenna that uses a unique coupling to the intentional radiator shall be considered sufficient to comply with the provisions of this section.

Result:

EUT use of a permanently attached antenna and a unique coupling to the intentional radiator, so it can comply with the provisions of this section.

***** END *****