

FCC TEST REPORT

Client Name : Anker Innovations Limited
Address : Room 1318-19, Hollywood Plaza, 610 Nathan Road,
Mongkok, Kowloon, Hong Kong
Product Name : PowerWave 10 Stand with 2 USB-A Ports
Date : Jun. 01, 2019

Shenzhen Anbotek Compliance Laboratory Limited

Contents

1. General Information.....	4
1.1. Client Information.....	4
1.2. Description of Device (EUT).....	4
1.3. Auxiliary Equipment Used During Test.....	4
1.4. Description of Test Modes.....	5
1.5. Description Of Test Setup.....	6
1.6. Test Equipment List.....	7
1.7. Measurement Uncertainty.....	8
1.8. Description of Test Facility.....	8
2. Summary of Test Results.....	9
3. Conducted Emission Test.....	10
3.1. Test Standard and Limit.....	10
3.2. Test Setup.....	10
3.3. Test Procedure.....	10
3.4. Test Data.....	10
4. Radiation Spurious Emission and Band Edge.....	15
4.1. Test Standard and Limit.....	15
4.2. Test Setup.....	15
4.3. Test Procedure.....	16
4.4. Test Data.....	17
5. Antenna Requirement.....	23
5.1. Test Standard and Requirement.....	23
5.2. Antenna Connected Construction.....	23
APPENDIX I -- TEST SETUP PHOTOGRAPH.....	错误！未定义书签。
APPENDIX II -- EXTERNAL PHOTOGRAPH.....	错误！未定义书签。
APPENDIX III -- INTERNAL PHOTOGRAPH.....	错误！未定义书签。

TEST REPORT

Applicant : Anker Innovations Limited
Manufacturer : Anker Innovations Limited
Product Name : PowerWave 10 Stand with 2 USB-A Ports
Model No. : A2573
Trade Mark : ANKER
Input: DC 12V, 3A
Rating(s) : Wireless Output: 7W/7.5W/10W
USB Output: DC 5V, 2.4A(Max)
Test Standard(s) : **FCC Part15 Subpart C 2018, Paragraph 15.209**
Test Method(s) : **ANSI C63.10: 2013**

The device described above is tested by Shenzhen Anbotek Compliance Laboratory Limited to determine the maximum emission levels emanating from the device and the severe levels of the device can endure and its performance criterion. The measurement results are contained in this test report and Shenzhen Anbotek Compliance Laboratory Limited is assumed full of responsibility for the accuracy and completeness of these measurements. Also, this report shows that the EUT (Equipment Under Test) is technically compliant with the FCC Part 15 Subpart C requirements.

This report applies to above tested sample only and shall not be reproduced in part without written approval of Shenzhen Anbotek Compliance Laboratory Limited.

Date of Receipt

May 16, 2019

Date of Test

May 16~27, 2019

Prepared By



Oliay Yang

(Engineer / Oliay Yang)

Reviewer

Snowy Meng

(Supervisor / Snowy Meng)

Approved & Authorized Signer

Sally Zhang

(Manager / Sally Zhang)

1. General Information

1.1. Client Information

Applicant	:	Anker Innovations Limited
Address	:	Room 1318-19, Hollywood Plaza, 610 Nathan Road, Mongkok, Kowloon, Hong Kong
Manufacturer	:	Anker Innovations Limited
Address	:	Room 1318-19, Hollywood Plaza, 610 Nathan Road, Mongkok, Kowloon, Hong Kong
Factory	:	Hinen Electronics(Shenzhen)Co., Ltd
Address	:	3/F, Building C and 4F, Building B and Building M, Licheng Technology Park, Shajing Sub-district, Bao'an District, Shenzhen City, Guangdong Province, China

1.2. Description of Device (EUT)

Product Name	:	PowerWave 10 Stand with 2 USB-A Ports
Model No.	:	A2573
Trade Mark	:	ANKER
Test Power Supply	:	AC 240V, 60Hz for adapter/ AC 120V, 60Hz for adapter
Test Sample No.	:	1-2-1(Normal Sample), 1-2-2(Engineering Sample)
Product Description	Operation Frequency:	111-205KHz
	Modulation Type:	MSK
	Antenna Type:	Inductive loop coil Antenna
	Antenna Gain(Peak):	0 dBi
Remark: 1) For a more detailed features description, please refer to the manufacturer's specifications or the User's Manual.		

1.3. Auxiliary Equipment Used During Test

Adapter	:	MODEL: ASSA79A-120300 INPUT: 100-240V~ 50/60Hz, 1.2A OUTPUT: 12.0V== 3.0A
---------	---	---

1.4. Description of Test Modes

To investigate the maximum EMI emission characteristics generates from EUT, the test system was pre-scanning tested base on the consideration of following EUT operation mode or test configuration mode which possible have effect on EMI emission level. Each of these EUT operation mode(s) or test configuration mode(s) mentioned above was evaluated respectively.

Pretest Mode	Description
Mode 1	Full load, Dual wireless charger module

For Conducted Emission	
Final Test Mode	Description
Mode 1	Full load, Dual wireless charger module

For Radiated Emission	
Final Test Mode	Description
Mode 1	Full load, Dual wireless charger module

Note: (1)Test channel is 0.1404MHz.

(2)All the situation(full load, half load and empty load) has been tested,only the worst situation (full load) was recorded in the report.

1.5. Description Of Test Setup

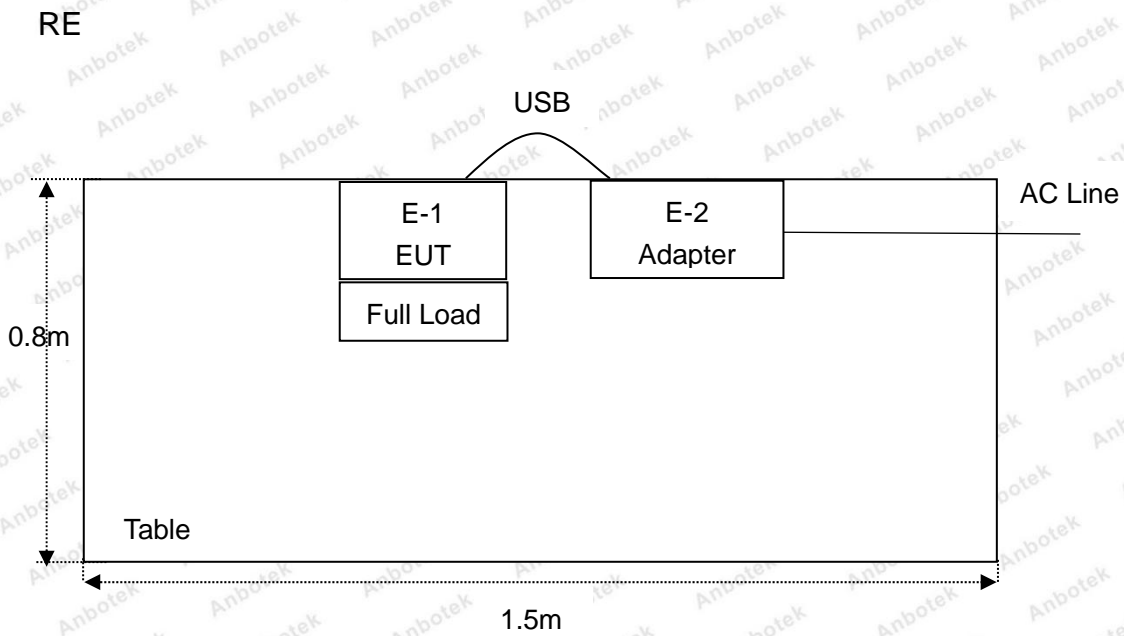
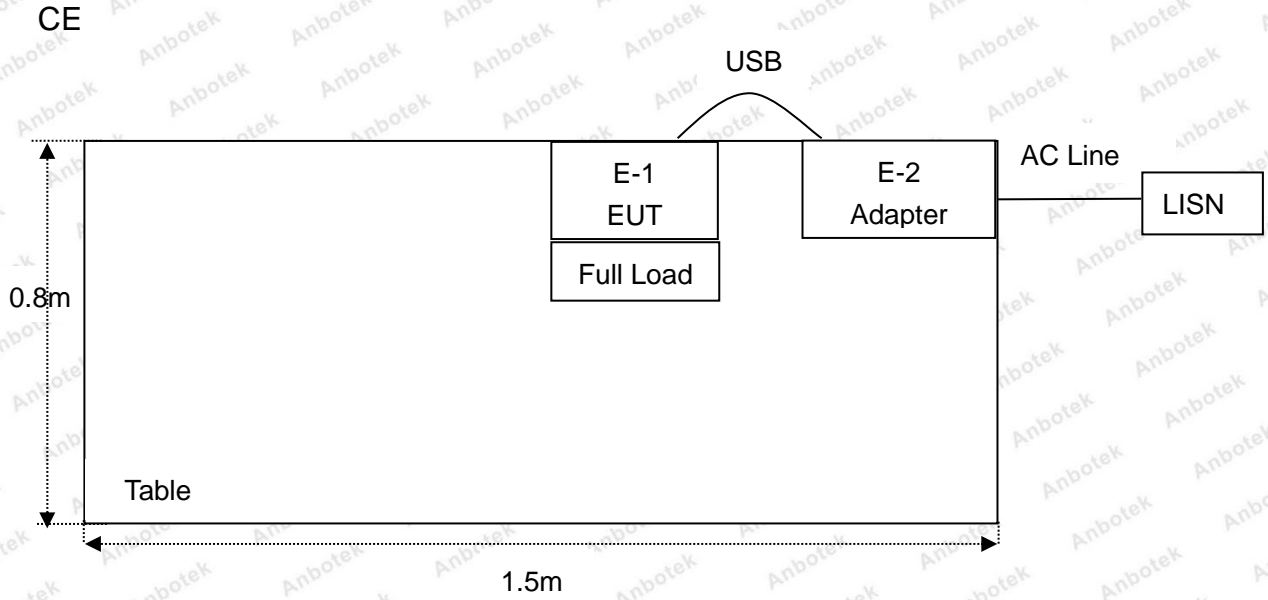

1.6. Test Equipment List

Item	Equipment	Manufacturer	Model No.	Serial No.	Last Cal.	Cal. Interval
1.	L.I.S.N. Artificial Mains Network	Rohde & Schwarz	ENV216	100055	Nov. 05, 2018	1 Year
2.	EMI Test Receiver	Rohde & Schwarz	ESPI3	101604	Nov. 05, 2018	1 Year
3.	RF Switching Unit	Compliance Direction	RSU-M2	38303	Nov. 05, 2018	1 Year
4.	Spectrum Analysis	Agilent	E4407B	US39390582	Nov. 05, 2018	1 Year
5.	MAX Spectrum Analysis	Agilent	N9020A	MY51170037	Nov. 05, 2018	1 Year
6.	Preamplifier	SKET Electronic	BK1G18G30 D	KD17503	Nov. 05, 2018	1 Year
7.	Double Ridged Horn Antenna	Instruments corporation	GTH-0118	351600	Nov. 20, 2018	1 Year
8.	Bilog Broadband Antenna	Schwarzbeck	VULB9163	VULB 9163-289	Nov. 19, 2018	1 Year
9.	Loop Antenna	Schwarzbeck	FMZB1519B	00053	Nov. 20, 2018	1 Year
10.	Horn Antenna	A-INFO	LB-180400- KF	J211060628	Nov. 20, 2018	1 Year
11.	Pre-amplifier	SONOMA	310N	186860	Nov. 05, 2018	1 Year
12.	EMI Test Software EZ-EMC	SHURPLE	N/A	N/A	N/A	N/A
13.	RF Test Control System	YIHENG	YH3000	2017430	Nov. 05, 2018	1 Year
14.	Power Sensor	DAER	RPR3006W	15I00041SN045	Nov. 05, 2018	1 Year
15.	Power Sensor	DAER	RPR3006W	15I00041SN046	Nov. 05, 2018	1 Year
16.	MXA Spectrum Analysis	Agilent	N9020A	MY51170037	Nov. 05, 2018	1 Year
17.	MXG RF Vector Signal Generator	Agilent	N5182A	MY48180656	Nov. 05, 2018	1 Year
18.	Signal Generator	Agilent	E4421B	MY41000743	Nov. 05, 2018	1 Year
19.	DC Power Supply	LW	TPR-6420D	374470	Oct. 31, 2018	1 Year
20.	Constant Temperature Humidity Chamber	ZHONGJIAN	ZJ-KHWS80 B	N/A	Nov. 01, 2018	1 Year

1.7. Measurement Uncertainty

Radiation Uncertainty	:	Ur = 3.9 dB (Horizontal)
		Ur = 3.8 dB (Vertical)
Conduction Uncertainty	:	Uc = 3.4 dB

1.8. Description of Test Facility

The test facility is recognized, certified, or accredited by the following organizations:

FCC-Registration No.: 184111

Shenzhen Anbotek Compliance Laboratory Limited, EMC Laboratory has been registered and fully described in a report filed with the (FCC) Federal Communications Commission. The acceptance letter from the FCC is maintained in our files. Registration No. 184111, July 31, 2017.

ISED-Registration No.: 8058A-1

Shenzhen Anbotek Compliance Laboratory Limited, EMC Laboratory has been registered and fully described in a report filed with the (ISED) Innovation, Science and Economic Development Canada. The acceptance letter from the ISED is maintained in our files. Registration 8058A-1, June 13, 2016.

Test Location

Shenzhen Anbotek Compliance Laboratory Limited.

1/F, Building D, Sogood Science and Technology Park, Sanwei community, Hangcheng Street, Bao'an District, Shenzhen, Guangdong, China.518102

2. Summary of Test Results

Standard Section	Test Item	Result
FCC Part 15, Paragraph 15.207	Conducted Emission Test	PASS
FCC Part 15, Paragraph 15.209(a)(f)	Spurious Emission	PASS
Part 15.203	Antenna Requirement	PASS



3. Conducted Emission Test

3.1. Test Standard and Limit

Test Standard	FCC Part15 Section 15.207		
Test Limit	Frequency	Maximum RF Line Voltage (dBuV)	
		Quasi-peak Level	Average Level
	150kHz~500kHz	66 ~ 56 *	56 ~ 46 *
	500kHz~5MHz	56	46
	5MHz~30MHz	60	50
Remark: (1) *Decreasing linearly with logarithm of the frequency. (2) The lower limit shall apply at the transition frequency.			

3.2. Test Setup

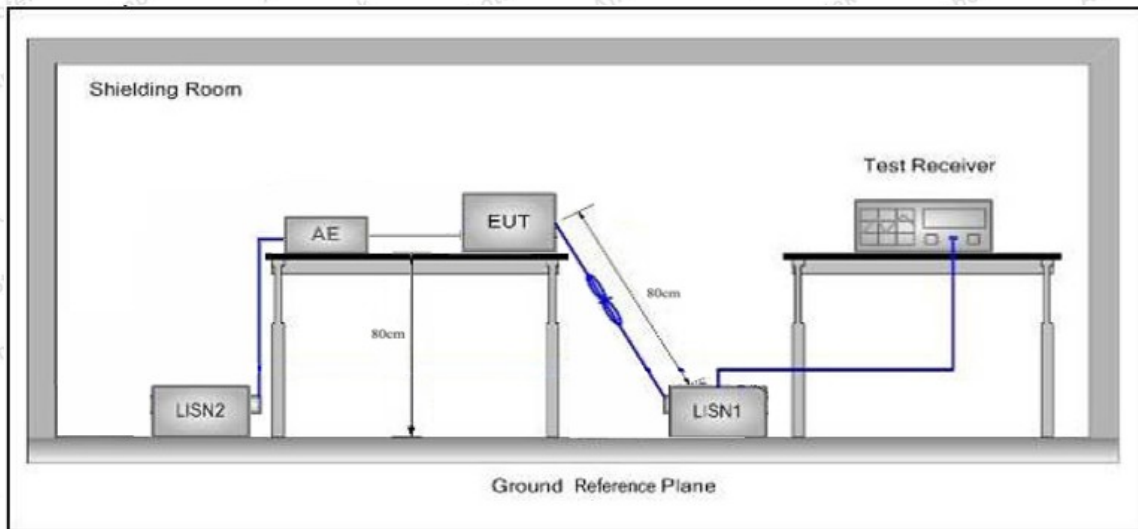

3.3. Test Procedure

The EUT system is connected to the power mains through a line impedance stabilization network (L.I.S.N.). This provides a 50ohm coupling impedance for the EUT system. Please refer the block diagram of the test setup and photographs. Both sides of AC line are checked to find out the maximum conducted emission. In order to find the maximum emission levels, the relative positions of equipment and all of the interface cables shall be changed according to FCC ANSI C63.10-2013 on Conducted Emission Measurement.

The bandwidth of test receiver (ESCI) set at 9kHz.

The frequency range from 150kHz to 30MHz is checked.

3.4. Test Data

Please to see the following pages

Conducted Emission Test Data

Test Site: 1# Shielded Room
 Operating Condition: Mode 1
 Test Specification: AC 240V, 60Hz for adapter
 Comment: Live Line
 Tem.: 21.9°C Hum.: 58%

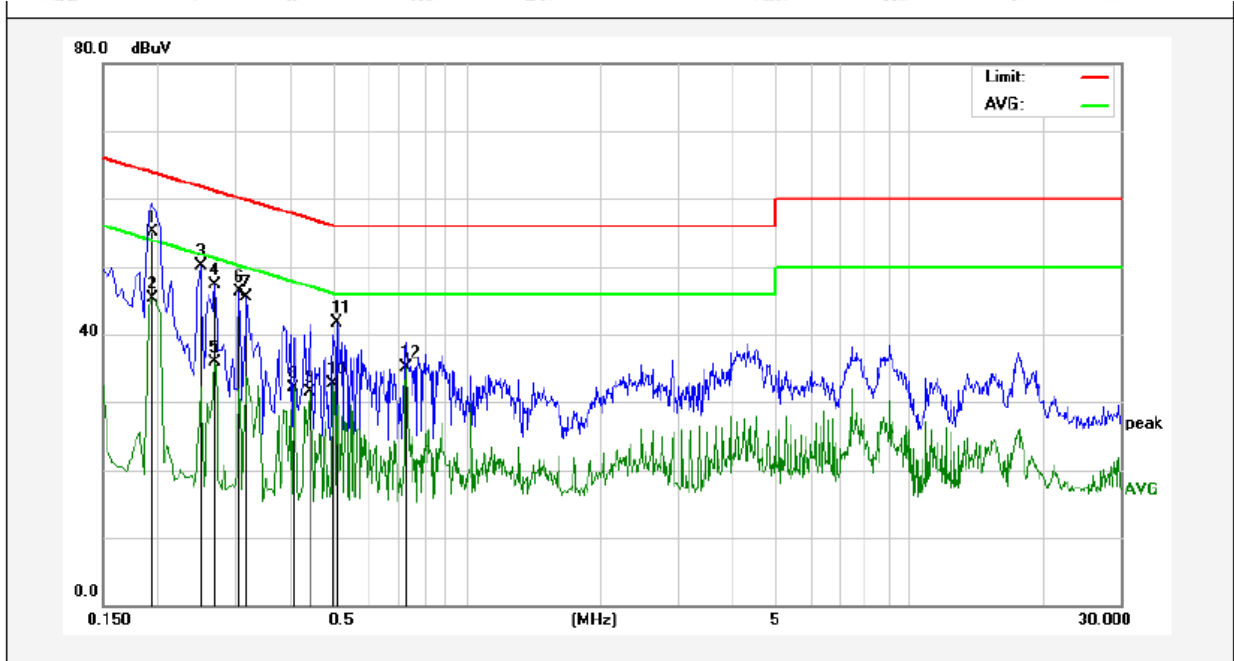

No.	Freq. (MHz)	Reading (dBuV)	Factor (dB)	Result (dBuV)	Limit dBuV	Over Limit (dB)	Detector	Remark
1	0.1940	35.28	19.90	55.18	63.86	-8.68	QP	
2	0.1940	25.44	19.90	45.34	53.86	-8.52	AVG	
3	0.2500	30.14	19.89	50.03	61.75	-11.72	QP	
4	0.2700	27.51	19.89	47.40	61.12	-13.72	QP	
5	0.2700	15.98	19.89	35.87	51.12	-15.25	AVG	
6	0.3060	26.32	19.89	46.21	60.08	-13.87	QP	
7	0.3180	25.60	19.90	45.50	59.76	-14.26	QP	
8	0.4060	12.08	19.94	32.02	47.73	-15.71	AVG	
9	0.4420	11.49	19.95	31.44	47.02	-15.58	AVG	
10	0.4980	12.78	19.98	32.76	46.03	-13.27	AVG	
11	0.5100	21.64	19.98	41.62	56.00	-14.38	QP	
12	0.7300	15.03	20.05	35.08	46.00	-10.92	AVG	

Conducted Emission Test Data

Test Site: 1# Shielded Room
 Operating Condition: Mode 1
 Test Specification: AC 240V, 60Hz for adapter
 Comment: Neutral Line
 Tem.: 21.9°C Hum.: 58%

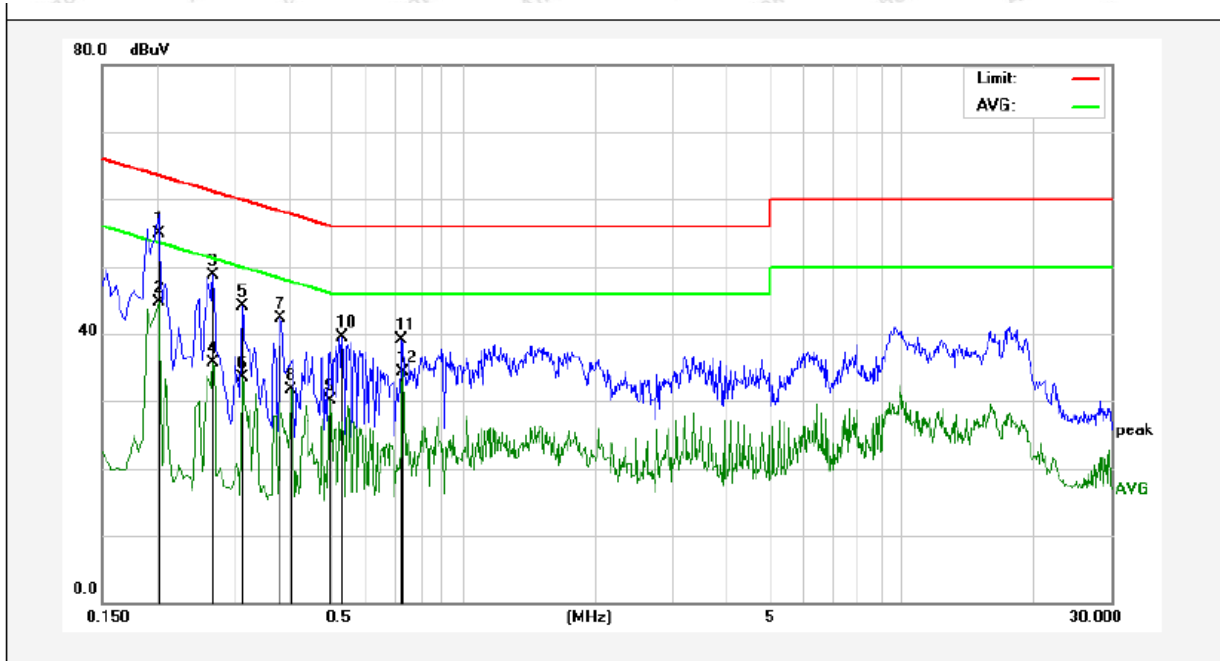

No.	Freq. (MHz)	Reading (dBuV)	Factor (dB)	Result (dBuV)	Limit dBuV	Over Limit (dB)	Detector	Remark
1	0.2020	34.92	19.90	54.82	63.52	-8.70	QP	
2	0.2020	24.80	19.90	44.70	53.52	-8.82	AVG	
3	0.2700	28.87	19.89	48.76	61.12	-12.36	QP	
4	0.2700	15.75	19.89	35.64	51.12	-15.48	AVG	
5	0.3140	24.16	19.90	44.06	59.86	-15.80	QP	
6	0.3140	13.65	19.90	33.55	49.86	-16.31	AVG	
7	0.3820	22.34	19.93	42.27	58.23	-15.96	QP	
8	0.4060	11.70	19.94	31.64	47.73	-16.09	AVG	
9	0.4980	10.08	19.98	30.06	46.03	-15.97	AVG	
10	0.5299	19.46	19.99	39.45	56.00	-16.55	QP	
11	0.7260	19.11	20.05	39.16	56.00	-16.84	QP	
12	0.7300	14.26	20.05	34.31	46.00	-11.69	AVG	

Conducted Emission Test Data

Test Site: 1# Shielded Room
 Operating Condition: Mode 1
 Test Specification: AC 120V, 60Hz for adapter
 Comment: Live Line
 Tem.: 21.9°C Hum.: 58%

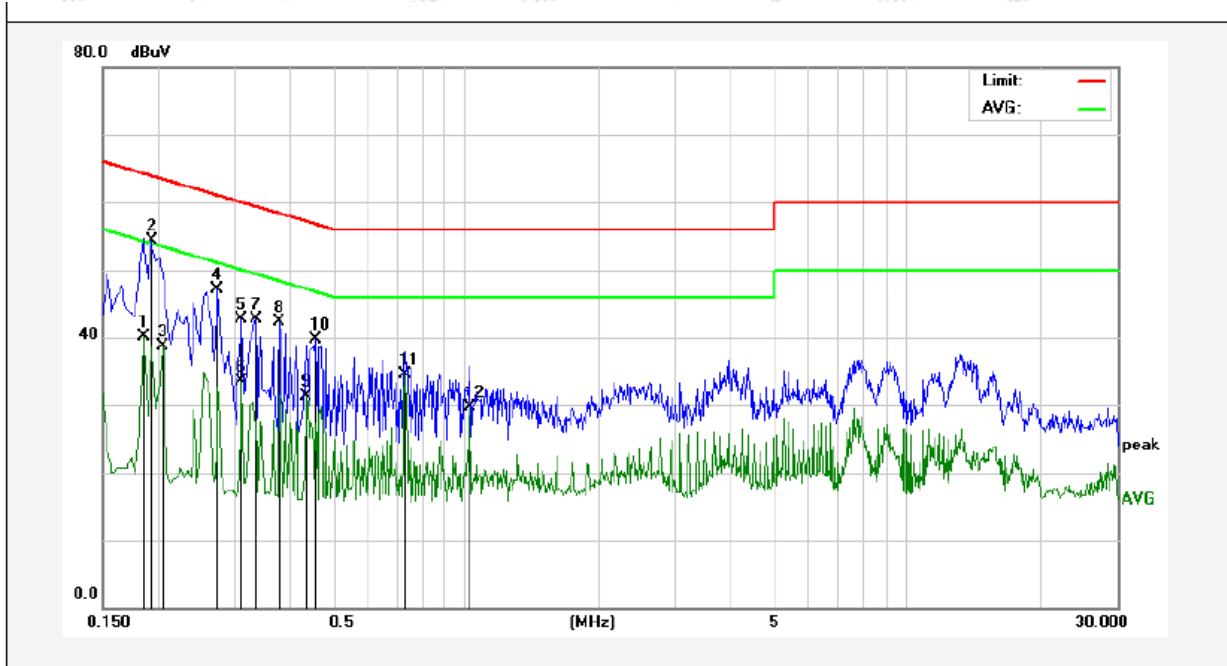

No.	Freq. (MHz)	Reading (dBuV)	Factor (dB)	Result (dBuV)	Limit dBuV	Over Limit (dB)	Detector	Remark
1	0.1860	20.18	19.90	40.08	54.21	-14.13	AVG	
2	0.1940	34.47	19.90	54.37	63.86	-9.49	QP	
3	0.2060	18.75	19.90	38.65	53.36	-14.71	AVG	
4	0.2740	27.30	19.89	47.19	60.99	-13.80	QP	
5	0.3100	22.73	19.89	42.62	59.97	-17.35	QP	
6	0.3100	13.59	19.89	33.48	49.97	-16.49	AVG	
7	0.3339	22.81	19.91	42.72	59.35	-16.63	QP	
8	0.3780	22.35	19.93	42.28	58.32	-16.04	QP	
9	0.4340	11.26	19.95	31.21	47.18	-15.97	AVG	
10	0.4580	19.71	19.96	39.67	56.73	-17.06	QP	
11	0.7300	14.50	20.05	34.55	46.00	-11.45	AVG	
12	1.0220	9.55	20.12	29.67	46.00	-16.33	AVG	

Conducted Emission Test Data

Test Site: 1# Shielded Room
 Operating Condition: Mode 1
 Test Specification: AC 120V, 60Hz for adapter
 Comment: Neutral Line
 Tem.: 21.9°C Hum.: 58%

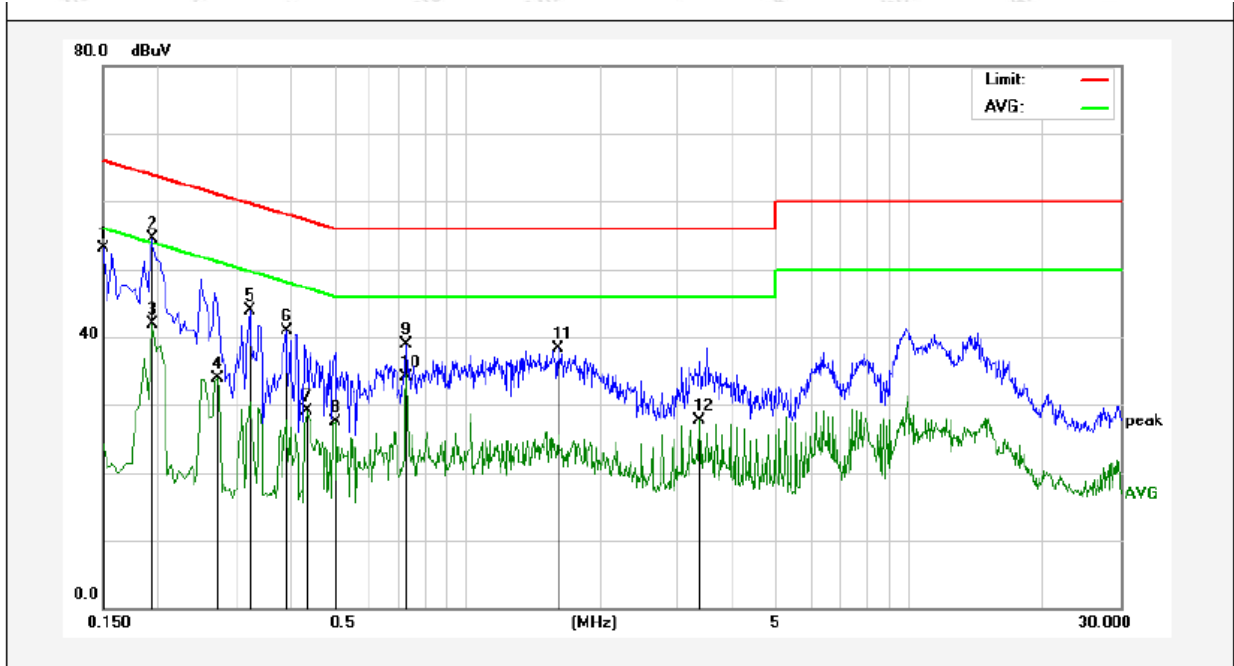

No.	Freq. (MHz)	Reading (dBuV)	Factor (dB)	Result (dBuV)	Limit dBuV	Over Limit (dB)	Detector	Remark
1	0.1500	33.15	19.90	53.05	65.99	-12.94	QP	
2	0.1940	34.54	19.90	54.44	63.86	-9.42	QP	
3	0.1940	22.05	19.90	41.95	53.86	-11.91	AVG	
4	0.2740	14.09	19.89	33.98	50.99	-17.01	AVG	
5	0.3220	24.05	19.90	43.95	59.65	-15.70	QP	
6	0.3899	20.88	19.93	40.81	58.06	-17.25	QP	
7	0.4340	9.10	19.95	29.05	47.18	-18.13	AVG	
8	0.5020	7.45	19.98	27.43	46.00	-18.57	AVG	
9	0.7300	18.90	20.05	38.95	56.00	-17.05	QP	
10	0.7300	14.15	20.05	34.20	46.00	-11.80	AVG	
11	1.6060	18.19	20.13	38.32	56.00	-17.68	QP	
12	3.3540	7.62	20.17	27.79	46.00	-18.21	AVG	

4. Radiation Spurious Emission and Band Edge

4.1. Test Standard and Limit

Test Standard	FCC Part15 C Section 15.209 and 15.205				
Test Limit	Frequency (MHz)	Field strength (microvolt/meter)	Limit (dBuV/m)	Remark	Measurement distance (m)
	0.009MHz~0.490MHz	2400/F(kHz)	-	-	300
	0.490MHz-1.705MHz	24000/F(kHz)	-	-	30
	1.705MHz-30MHz	30	-	-	30
	30MHz~88MHz	100	40.0	Quasi-peak	3
	88MHz~216MHz	150	43.5	Quasi-peak	3
	216MHz~960MHz	200	46.0	Quasi-peak	3
	960MHz~1000MHz	500	54.0	Quasi-peak	3
	Above 1000MHz	500	54.0	Average	3
-		74.0	Peak	3	

Remark:

- (1)The lower limit shall apply at the transition frequency.
- (2) 15.35(b), Unless otherwise specified, the limit on peak radio frequency emissions is 20dB above the maximum permitted average emission limit applicable to the equipment under test. This peak limit applies to the total peak emission level radiated by the device.

4.2. Test Setup

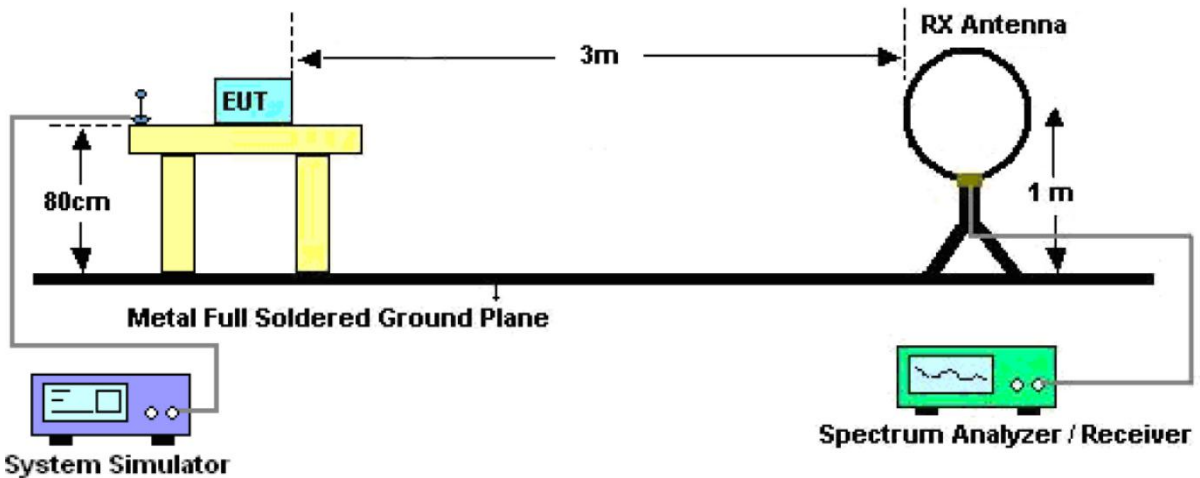

Figure 1. Below 30MHz

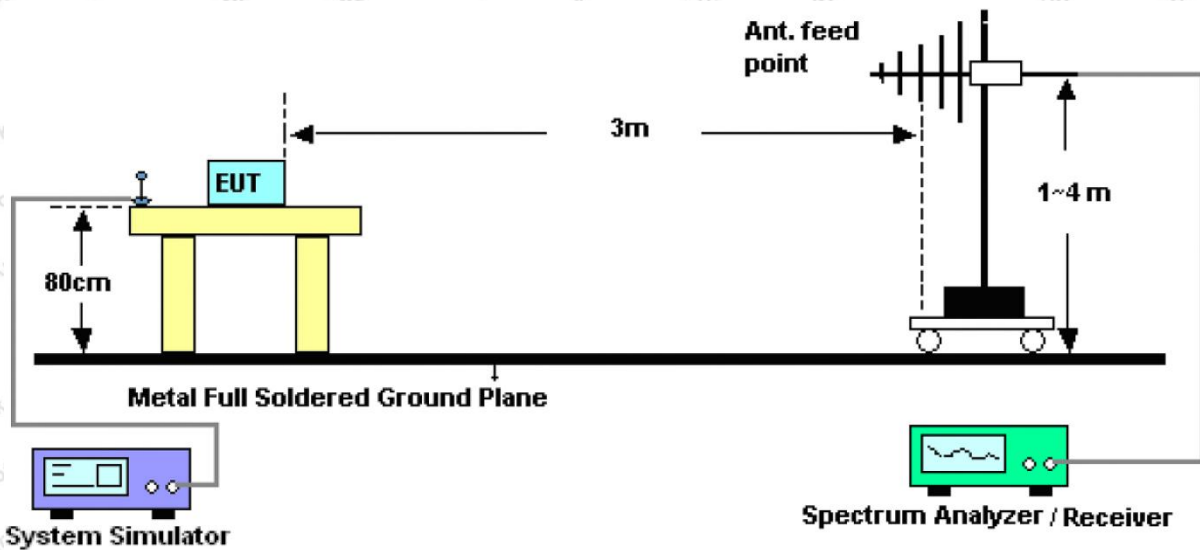

Figure 2. 30MHz to 1GHz

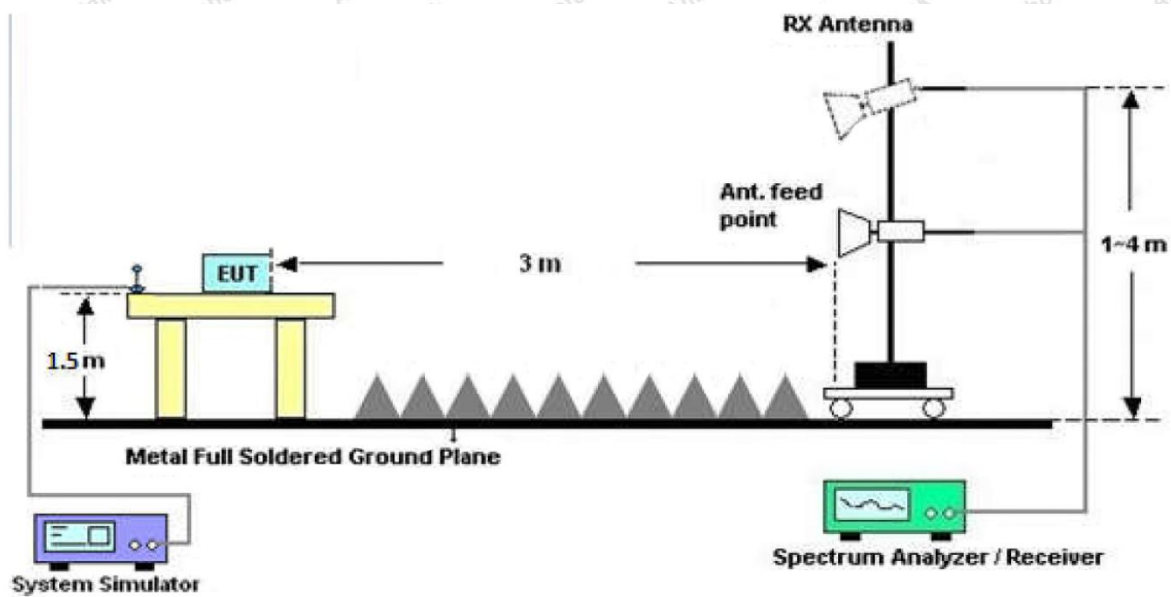

Figure 3. Above 1 GHz

4.3. Test Procedure

For below 1GHz: The EUT is placed on a turntable, which is 0.8m above the ground plane.

For above 1GHz: The EUT is placed on a turntable, which is 1.5m above the ground plane.

The turn table can rotate 360 degrees to determine the position of the maximum emission level. The EUT is set 3 meters away from the receiving antenna which is mounted on a antenna tower. The antenna can be moved up and down from 1 to 4 meters to find out the maximum emission level. Rotated the EUT through three orthogonal axes to determine the maximum emissions, both horizontal and vertical polarization of the antenna are set on test. The EUT is tested in 9*6*6 Chamber. The device is evaluated in xyz orientation.

For 9kHz to 150kHz, Set the spectrum analyzer as:

RBW = 200Hz, VBW = 1kHz, Detector= Quasi-Peak, Trace mode= Max hold, Sweep- auto couple.

For 150kHz to 30MHz, Set the spectrum analyzer as:

RBW = 9kHz, VBW = 30kHz, Detector= Quasi-Peak, Trace mode= Max hold, Sweep- auto couple.

For 30MHz to 1000MHz, Set the spectrum analyzer as:

RBW = 100kHz, VBW = 300kHz, Detector= Quasi-Peak, Trace mode= Max hold, Sweep- auto couple.

4.4. Test Data

PASS

Note: The data is in TX mode, and this is the worst mode.

Test Results

(Between 9KHz – 30MHz)

Job No.: SZAWW190516003-01
Standard: FCC PART15 C_3m **Power Source:** AC 120V, 60Hz for adapter
Test item: Radiation Test **Temp.(C)/Hum.(%RH):** 21.9°C/58%RH
Test Mode: Mode 1 **Distance:** 3m



Frequency (MHz)	Read Level (dBuV)	Antenna Factor (dB/m)	Cable Loss (dB)	Preamp Factor (dB)	Level (dBuV/m)	Limit (dBuV/m)	Over Limit (dB)	Detector	degree (dge)
0.0352	51.73	19.28	2.53	0	73.54	136.55	-63.01	Peak	30
0.0352	41.77	19.28	2.53	0	63.58	116.55	-52.97	AV	30
0.1408	60.18	19.38	2.55	0	82.11	124.57	-42.46	Peak	180
0.1408	50.54	19.38	2.55	0	72.47	104.57	-32.10	AV	180
0.2872	44.01	19.40	2.57	0	65.98	118.41	-52.43	Peak	110
0.2872	32.09	19.40	2.57	0	54.06	98.41	-44.35	AV	110
0.4259	47.20	19.40	2.64	0	69.24	115.01	-45.77	Peak	90
0.4259	37.56	19.40	2.64	0	59.60	95.01	-35.41	AV	90
0.6975	25.96	19.50	2.64	0	48.10	70.73	-22.63	QP	65
2.9700	19.83	19.65	2.74	0	42.22	69.54	-27.32	QP	41

Remark: According to FCC PART 15.209 (d), the emission limits for the frequency bands 9–90 kHz, 110–490 kHz and above 1000 MHz, Radiated emission limits in these three bands are based on measurements employing an average detector.

(Between 30MHz –1000 MHz)

Job No.:	SZAWW190516003-01	Polarization:	Horizontal
Standard:	FCC PART15 C_3m	Power Source:	AC 120V, 60Hz for adapter
Test item:	Radiation Test	Temp.(C)/Hum.(%RH):	23.4°C/55.1%RH
Test Mode:	Mode 1	Distance:	3m

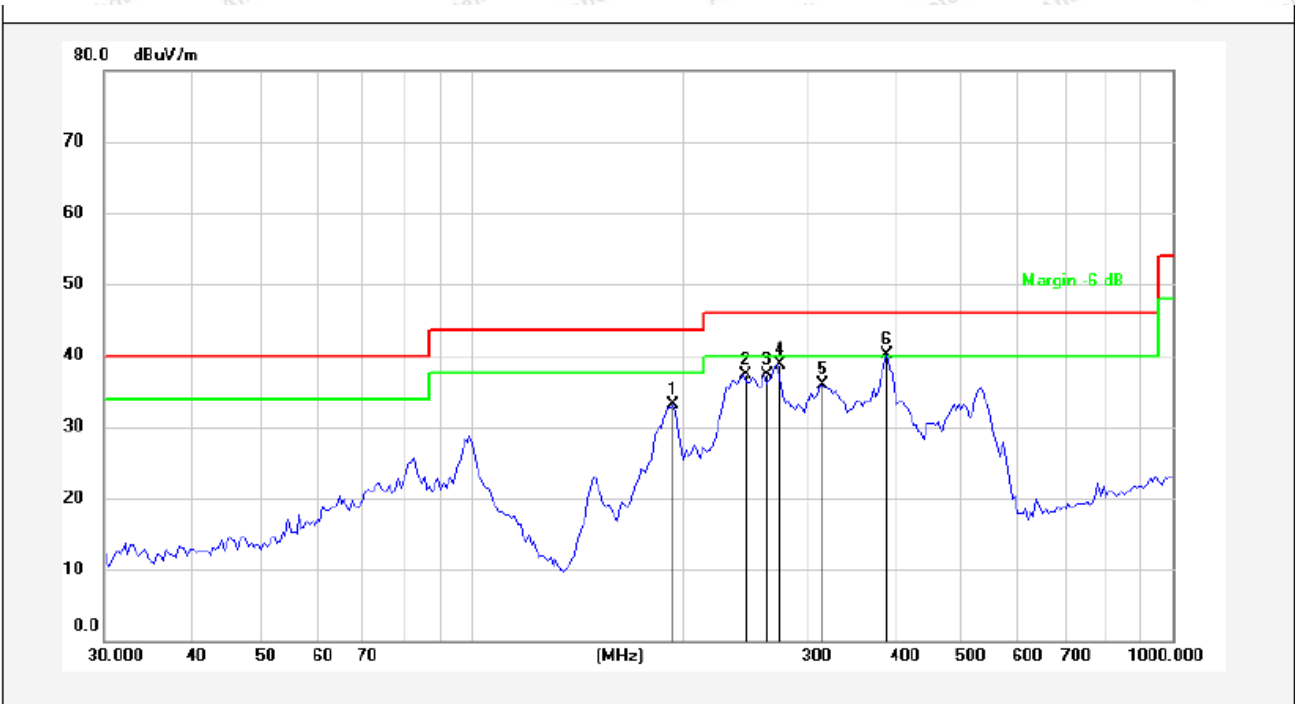

No.	Freq. (MHz)	Reading (dBuV)	Factor ()	Result (dBuV/m)	Limit (dBuV/m)	Over Limit (dB)	Detector	Height (cm)	degree (deg)	Remark
1	194.1128	54.59	-21.43	33.16	43.50	-10.34	QP	300	0	
2	243.8043	56.29	-19.05	37.24	46.00	-8.76	QP	300	54	
3	261.5164	57.03	-19.76	37.27	46.00	-8.73	QP	300	121	
4	273.2341	58.18	-19.38	38.80	46.00	-7.20	QP	300	222	
5	314.3765	53.06	-17.12	35.94	46.00	-10.06	QP	300	333	
6	391.4082	54.78	-14.76	40.02	46.00	-5.98	QP	300	360	

Job No.:	SZAWW190516003-01	Polarization:	Vertical
Standard:	FCC PART15 C_3m	Power Source:	AC 120V, 60Hz for adapter
Test item:	Radiation Test	Temp.(C)/Hum.(%RH):	23.4°C/55.1%RH
Test Mode:	Mode 1	Distance:	3m



No.	Freq. (MHz)	Reading (dBuV)	Factor ()	Result (dBuV/m)	Limit (dBuV/m)	Over Limit (dB)	Detector	Height (cm)	degree (deg)	Remark
1	192.4186	48.59	-16.85	31.74	43.50	-11.76	QP	300	0	
2	204.5961	44.70	-16.65	28.05	43.50	-15.45	QP	300	47	
3	237.4760	55.17	-15.03	40.14	46.00	-5.86	QP	300	97	
4	466.4165	49.21	-13.87	35.34	46.00	-10.66	QP	300	106	
5	500.3011	50.97	-12.99	37.98	46.00	-8.02	QP	300	352	
6	531.9635	48.33	-12.21	36.12	46.00	-9.88	QP	300	360	

Job No.:	SZAWW190516003-01	Polarization:	Horizontal
Standard:	FCC PART15 C_3m	Power Source:	AC 240V, 60Hz for adapter
Test item:	Radiation Test	Temp.(C)/Hum.(%RH):	23.4°C/55.1%RH
Test Mode:	Mode 1	Distance:	3m

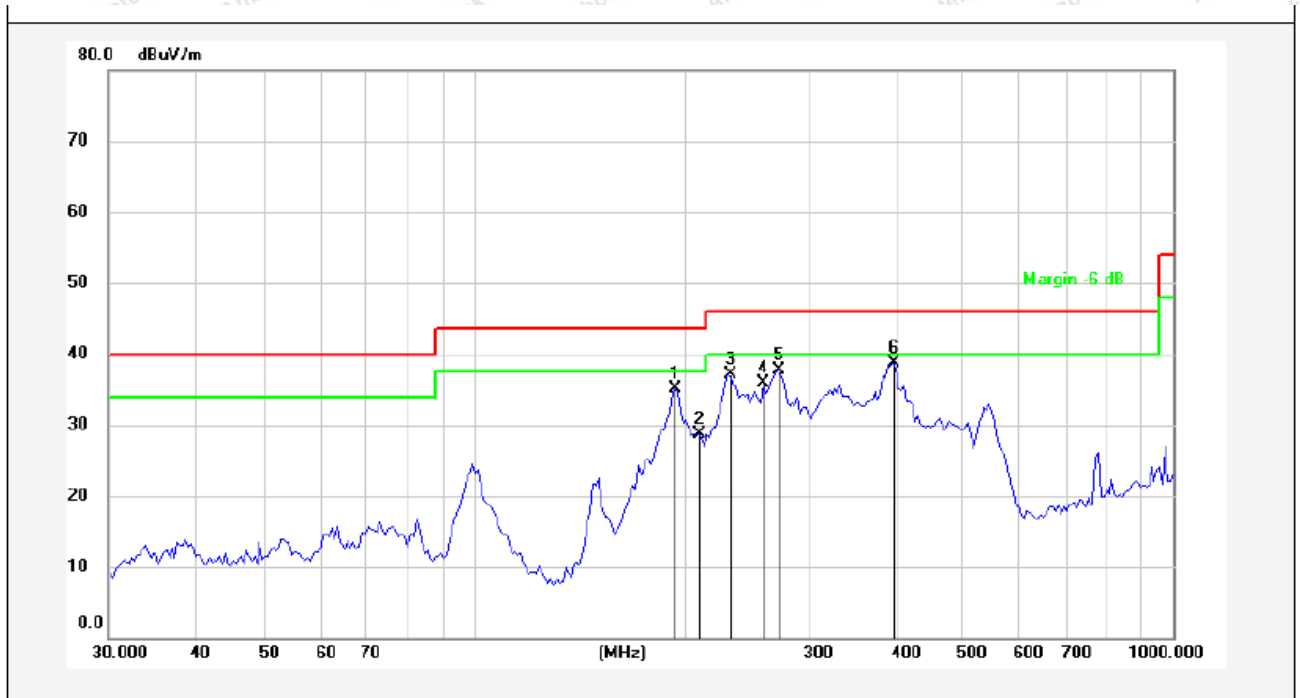

No.	Freq. (MHz)	Reading (dBuV)	Factor ()	Result (dBuV/m)	Limit (dBuV/m)	Over Limit (dB)	Detector	Height (cm)	degree (deg)	Remark
1	194.1126	56.57	-21.43	35.14	43.50	-8.36	QP	300	0	
2	210.0482	49.67	-20.93	28.74	43.50	-14.76	QP	300	77	
3	231.3120	56.89	-19.80	37.09	46.00	-8.91	QP	300	103	
4	259.2338	55.70	-19.77	35.93	46.00	-10.07	QP	300	141	
5	270.8493	57.08	-19.46	37.62	46.00	-8.38	QP	300	297	
6	398.3312	53.28	-14.67	38.61	46.00	-7.39	QP	300	360	

Job No.: SZAWW190516003-01 **Polarization:** Vertical
Standard: FCC PART15 C_3m **Power Source:** AC 240V, 60Hz for adapter
Test item: Radiation Test **Temp.(C)/Hum.(%RH):** 23.4°C/55.1%RH
Test Mode: Mode 1 **Distance:** 3m

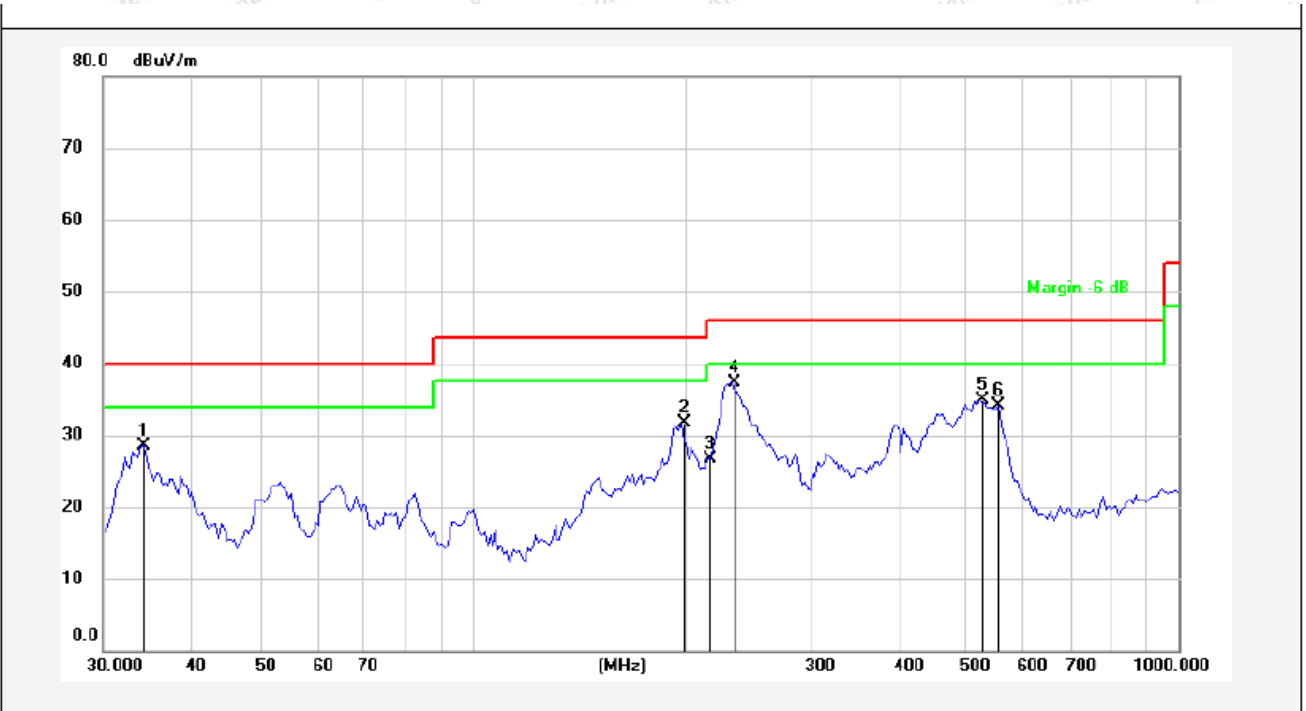

No.	Freq. (MHz)	Reading (dBuV)	Factor ()	Result (dBuV/m)	Limit (dBuV/m)	Over Limit (dB)	Detector	Height (cm)	degree (deg)	Remark
1	34.2160	44.53	-16.02	28.51	40.00	-11.49	QP	300	0	
2	197.5462	48.49	-16.84	31.65	43.50	-11.85	QP	300	67	
3	215.6456	42.88	-16.19	26.69	43.50	-16.81	QP	300	127	
4	233.3487	52.63	-15.27	37.36	46.00	-8.64	QP	300	263	
5	522.7180	47.31	-12.45	34.86	46.00	-11.14	QP	300	297	
6	555.7990	45.75	-11.65	34.10	46.00	-11.90	QP	300	360	

5. Antenna Requirement

5.1. Test Standard and Requirement

Test Standard	FCC Part15 Section 15.203
Requirement	An intentional radiator shall be designed to ensure that no antenna other than that furnished by the responsible party shall be used with the device. The use of a permanently attached antenna or of an antenna that uses a unique coupling to the intentional radiator, the manufacturer may design the unit so that a broken antenna can be replaced by the user, but the use of a standard antenna jack or electrical connector is prohibited.

5.2. Antenna Connected Construction

The antenna is a Inductive loop coil Antenna which permanently attached, and the best case gain of the antenna is 0 dBi. It complies with the standard requirement.



----- End of Report -----