



LTE Band 12 16QAM 3MHz CH-Low, 100%RB



LTE Band 12 16QAM 3MHz CH-High, 100%RB



LTE Band 12 16QAM 5MHz CH-Low, 1 RB

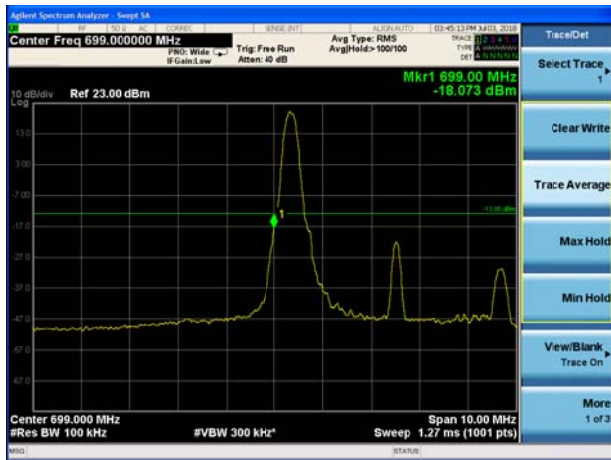

LTE Band 12 16QAM 5MHz CH-High, 1 RB

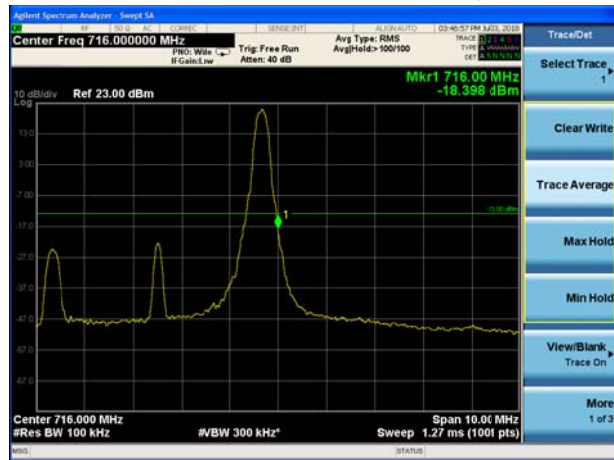

LTE Band 12 16QAM 5MHz CH-Low, 100%RB



LTE Band 12 16QAM 5MHz CH-High, 100%RB





LTE Band 12 16QAM 10MHz CH-Low, 1 RB

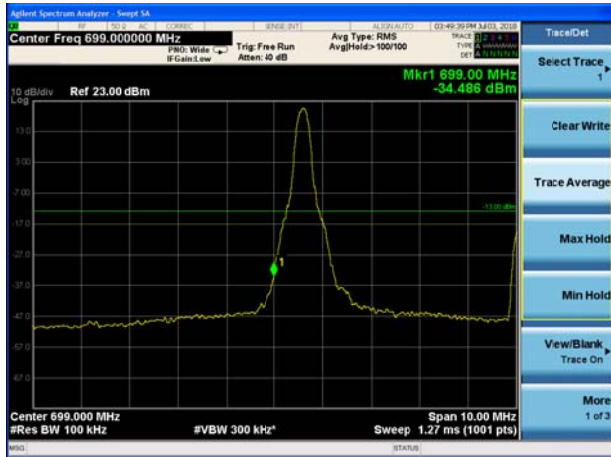

LTE Band 12 16QAM 10MHz CH-High, 1 RB

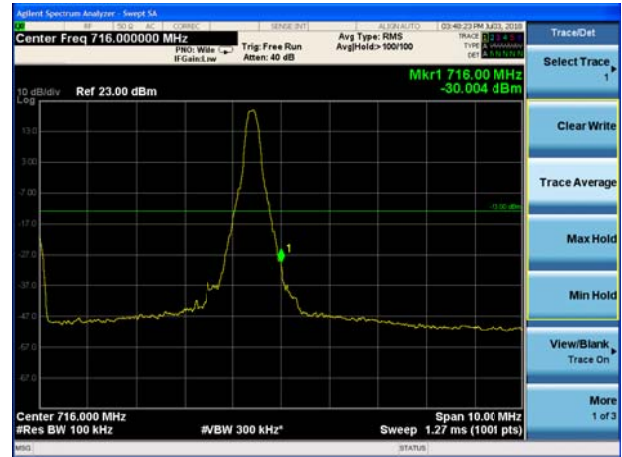

LTE Band 12 16QAM 10MHz CH-Low, 100%RB



LTE Band 12 16QAM 10MHz CH-High, 100%RB



LTE Band 13 QPSK 5MHz CH-Low, 1 RB (763MHz ~775MHz)



LTE Band 13 QPSK 5MHz CH-High, 1 RB (775MHz ~777MHz)

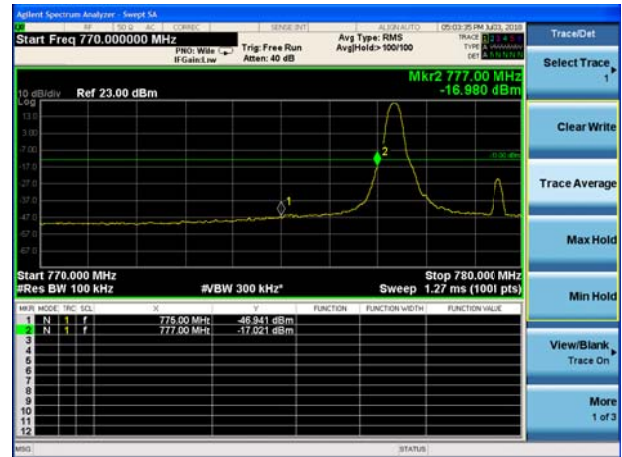



LTE Band 13 QPSK 5MHz CH-High, 1 RB (787MHz ~793MHz)

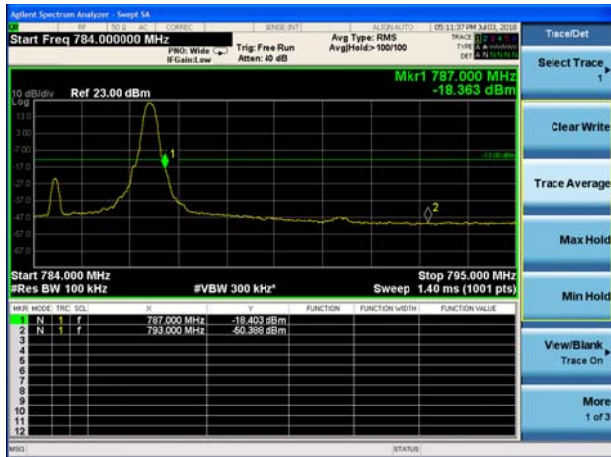

LTE Band 13 QPSK 5MHz CH-High, 1 RB (793MHz ~805MHz)

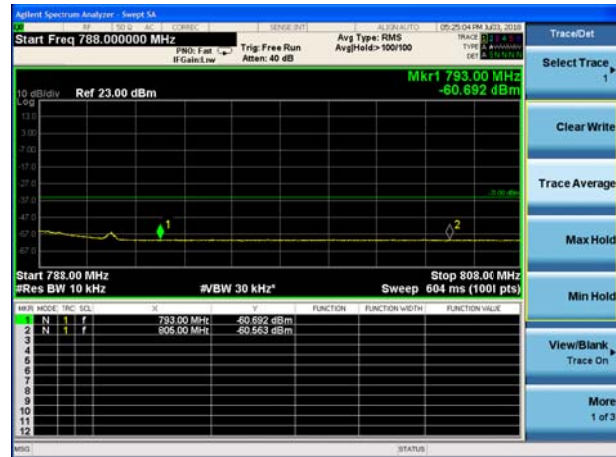

LTE Band 13 QPSK 5MHz CH-Low, 100%RB (763MHz ~775MHz)



LTE Band 13 QPSK 5MHz CH-Low, 100%RB (775MHz ~777MHz)



LTE Band 13 QPSK 5MHz CH-High, 100%RB (787MHz ~793MHz)



LTE Band 13 QPSK 5MHz CH-High, 100%RB (793MHz ~805MHz)





LTE Band 13 QPSK 10MHz CH-Low, 1 RB  
(763MHz ~775MHz)



LTE Band 13 QPSK 10MHz CH-Low, 1 RB  
(775MHz ~777MHz)

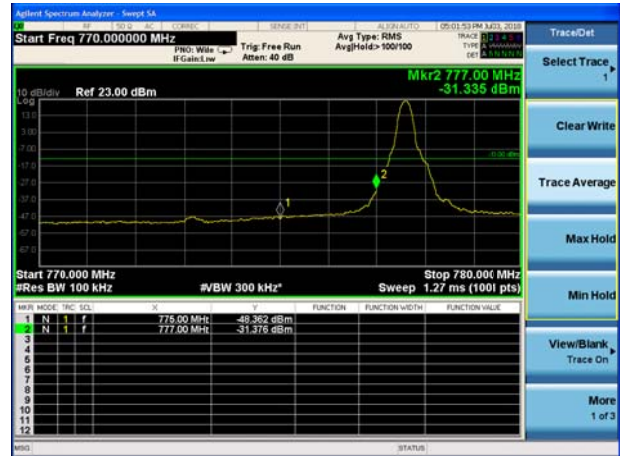

LTE Band 13 QPSK 10MHz CH-High, 1 RB  
(787MHz ~793MHz)

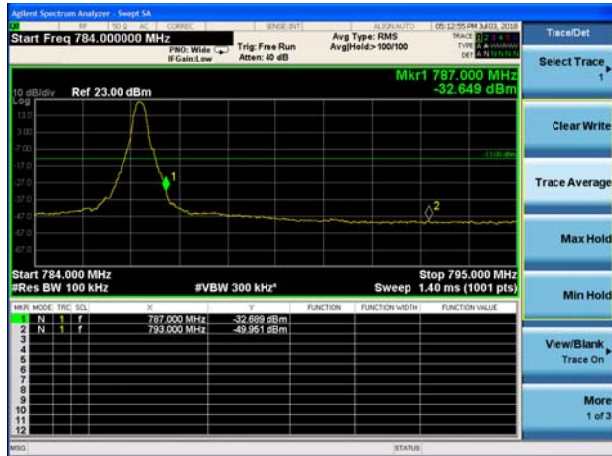

LTE Band 13 QPSK 10MHz CH-High, 1 RB  
(793MHz ~805MHz)



LTE Band 13 QPSK 10MHz CH-Low, 100%RB  
(763MHz ~775MHz)



LTE Band 13 QPSK 10MHz CH-Low, 100%RB  
(775MHz ~777MHz)





LTE Band 13 QPSK 10MHz CH-High, 100%RB (787MHz ~793MHz)



LTE Band 13 QPSK 10MHz CH-High, 100%RB (793MHz ~805MHz)



LTE Band 13 16QAM 5MHz CH-Low, 1 RB (763MHz ~775MHz)

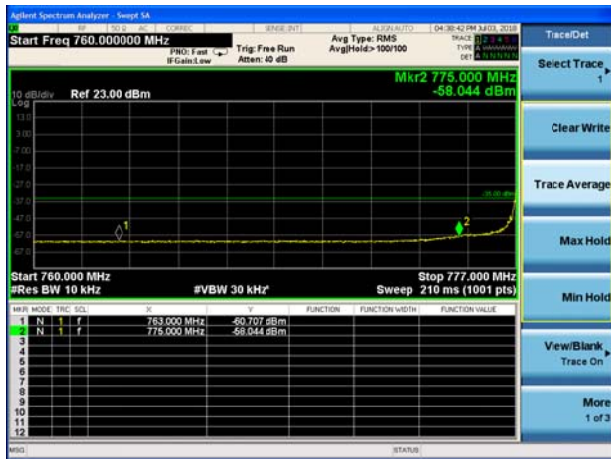

LTE Band 13 16QAM 5MHz CH-Low, 1 RB (775MHz ~777MHz)

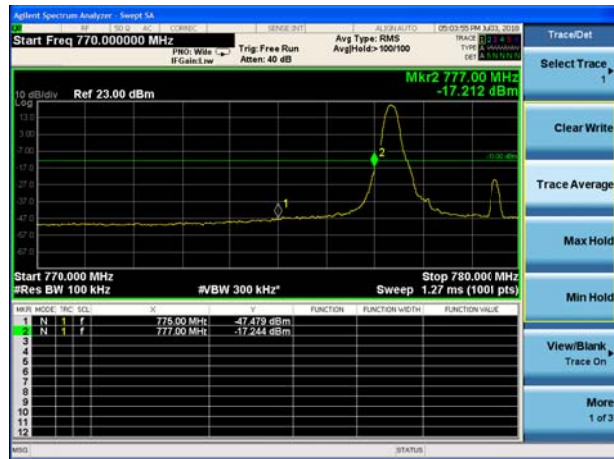

LTE Band 13 16QAM 5MHz CH-High, 1 RB (787MHz ~793MHz)

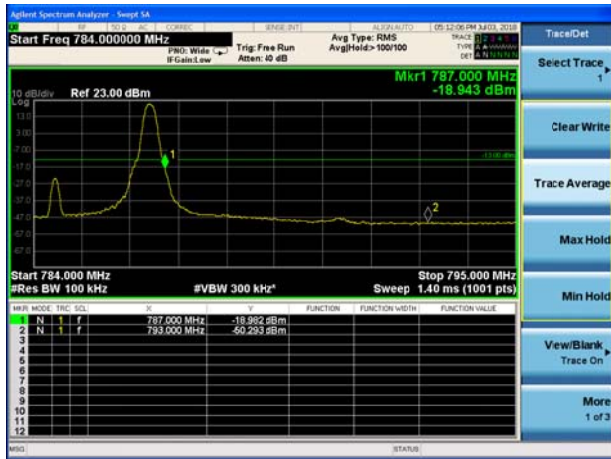

LTE Band 13 16QAM 5MHz CH-High, 1 RB (793MHz ~805MHz)



LTE Band 13 16QAM 5MHz CH-Low, 100%RB  
(763MHz ~775MHz)



LTE Band 13 16QAM 5MHz CH-Low, 100%RB  
(775MHz ~777MHz)



LTE Band 13 16QAM 5MHz CH-High, 100%RB  
(787MHz ~793MHz)



LTE Band 13 16QAM 5MHz CH-High, 100%RB  
(793MHz ~805MHz)



LTE Band 13 16QAM 10MHz CH-Low, 1 RB  
(763MHz ~775MHz)

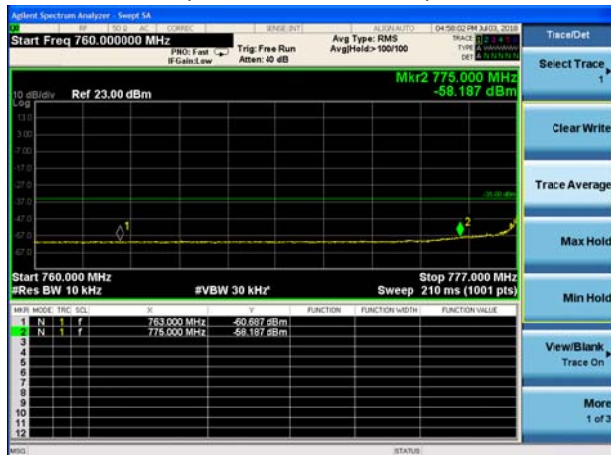

LTE Band 13 16QAM 10MHz CH-Low, 1 RB  
(775MHz ~777MHz)

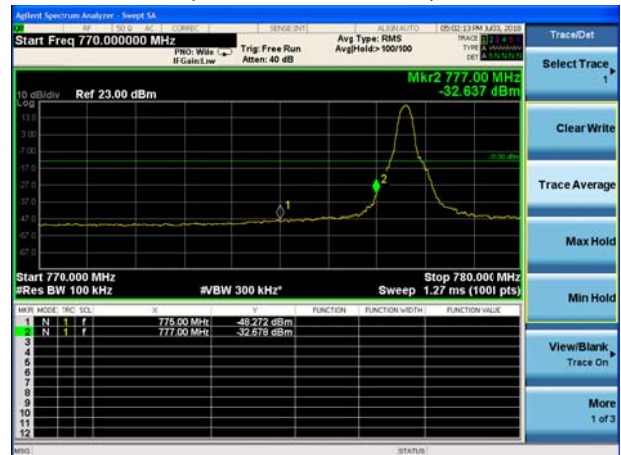



LTE Band 13 16QAM 10MHz CH-High, 1 RB (787MHz ~793MHz)

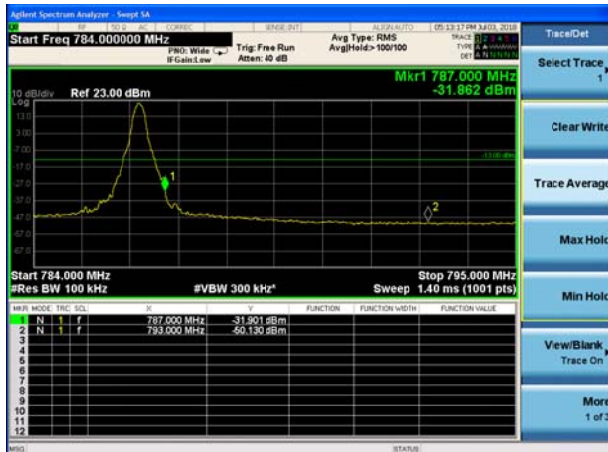

LTE Band 13 16QAM 10MHz CH-High, 1 RB (793MHz ~805MHz)



LTE Band 13 16QAM 10MHz CH-Low, 100%RB (763MHz ~775MHz)



LTE Band 13 16QAM 10MHz CH-Low, 100%RB (775MHz ~777MHz)



LTE Band 13 16QAM 10MHz CH-High, 100%RB (787MHz ~793MHz)



LTE Band 13 16QAM 10MHz CH-High, 100%RB (793MHz ~805MHz)





LTE Band 66 QPSK 1.4MHz CH-Low, 1 RB

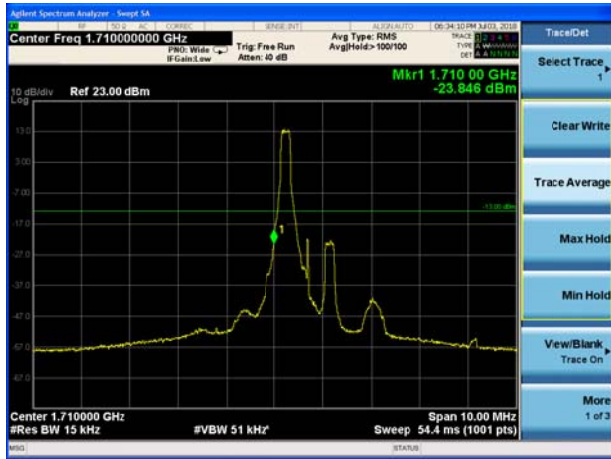

LTE Band 66 QPSK 1.4MHz CH-High, 1 RB



LTE Band 66 QPSK 1.4MHz CH-Low, 100%RB



LTE Band 66 QPSK 1.4MHz CH-High, 100%RB



LTE Band 66 QPSK 3MHz CH-Low, 1 RB

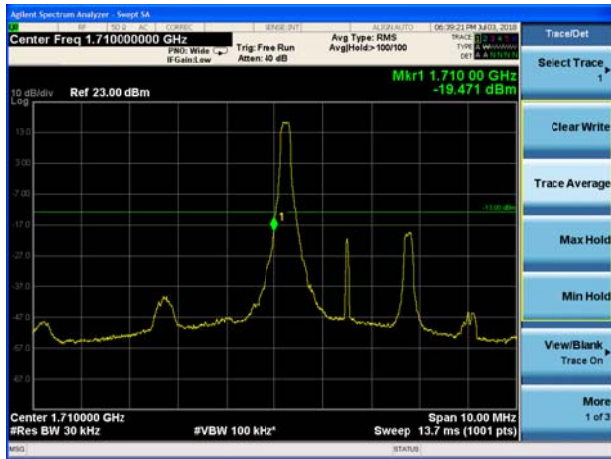

LTE Band 66 QPSK 3MHz CH-High, 1 RB

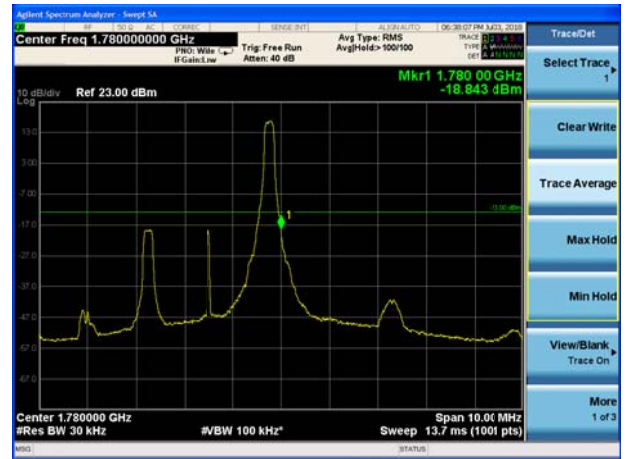





LTE Band 66 QPSK 3MHz CH-Low, 100%RB



LTE Band 66 QPSK 3MHz CH-High, 100%RB



LTE Band 66 QPSK 5MHz CH-Low, 1 RB

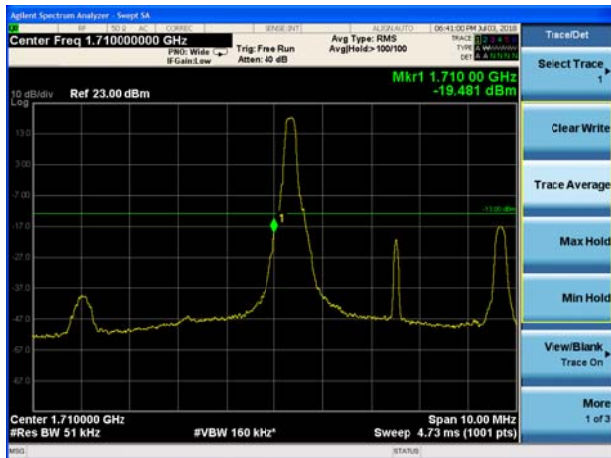

LTE Band 66 QPSK 5MHz CH-High, 1 RB

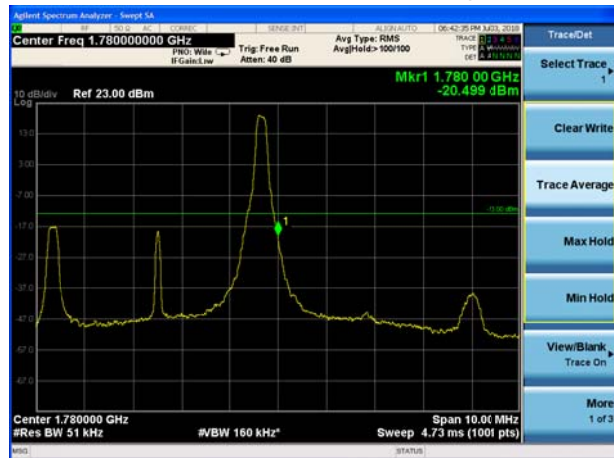

LTE Band 66 QPSK 5MHz CH-Low, 100%RB

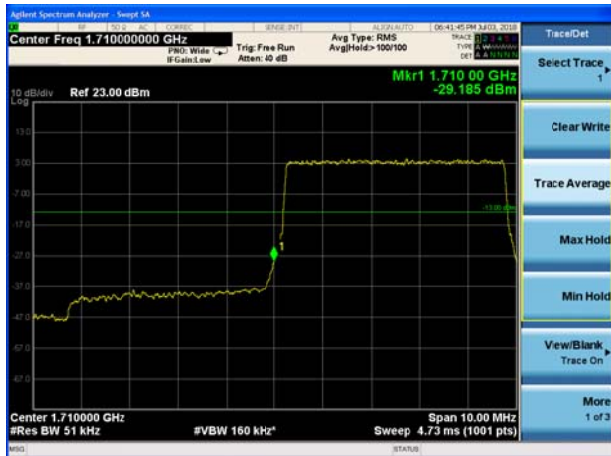

LTE Band 66 QPSK 5MHz CH-High, 100%RB





LTE Band 66 QPSK 10MHz CH-Low, 1 RB

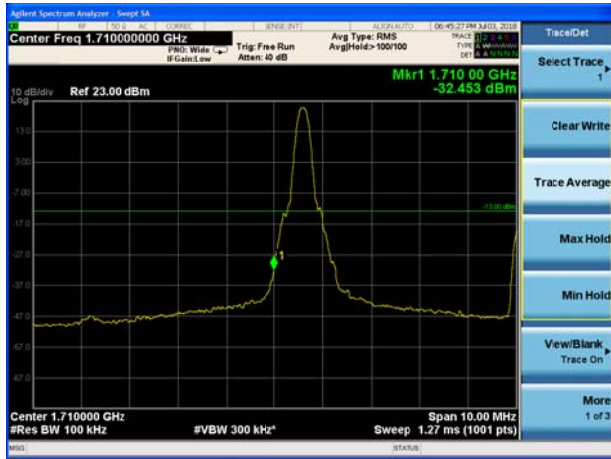

LTE Band 66 QPSK 10MHz CH-High, 1 RB

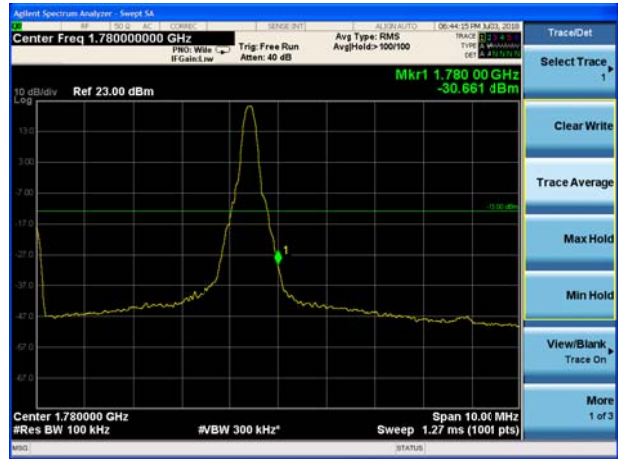

LTE Band 66 QPSK 10MHz CH-Low, 100%RB

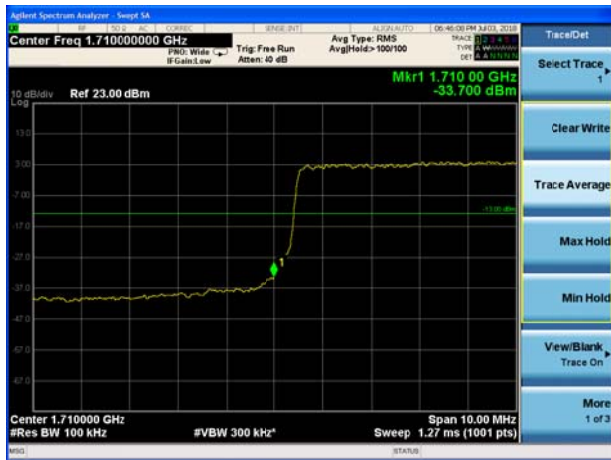

LTE Band 66 QPSK 10MHz CH-High, 100%RB



LTE Band 66 QPSK 15MHz CH-Low, 1 RB

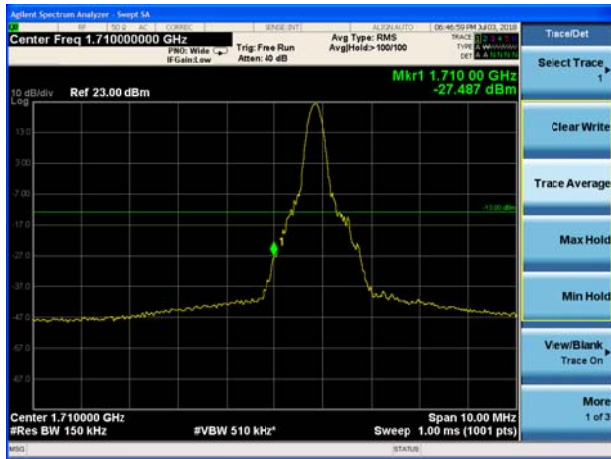

LTE Band 66 QPSK 15MHz CH-High, 1 RB

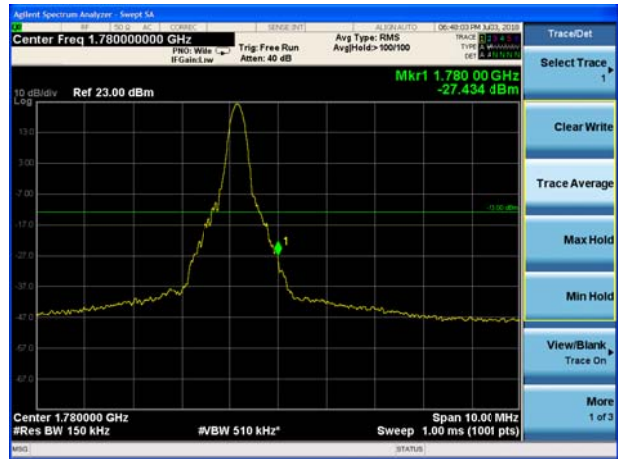



LTE Band 66 QPSK 15MHz CH-Low, 100%RB



LTE Band 66 QPSK 15MHz CH-High, 100%RB

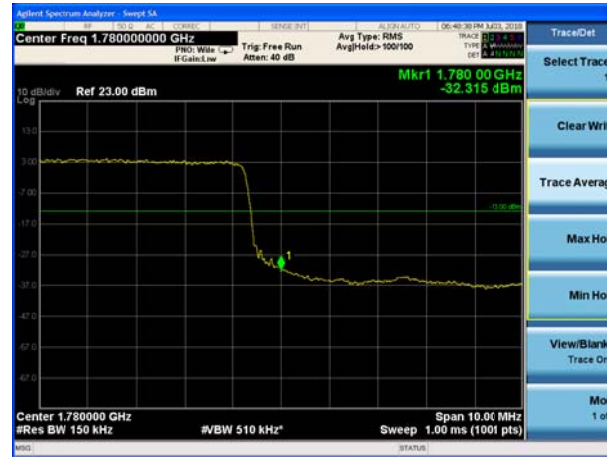

LTE Band 66 QPSK 20MHz CH-Low, 1 RB

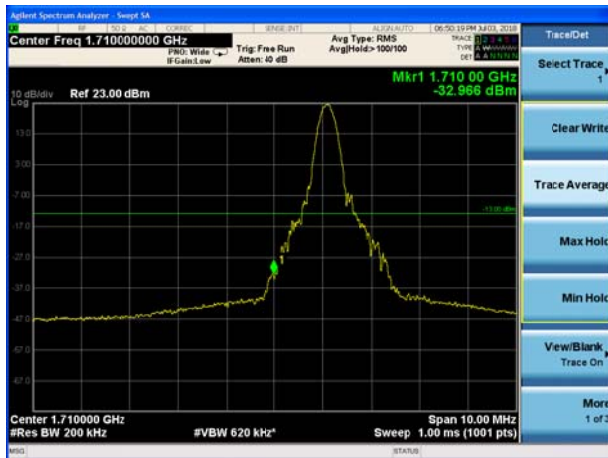

LTE Band 66 QPSK 20MHz CH-High, 1 RB

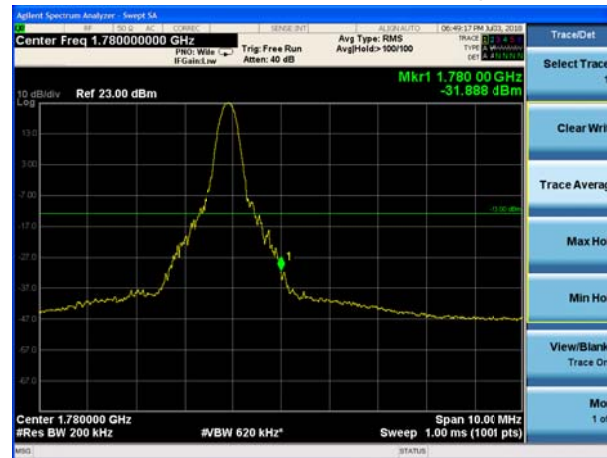

LTE Band 66 QPSK 20MHz CH-Low, 100%RB



LTE Band 66 QPSK 20MHz CH-High, 100%RB

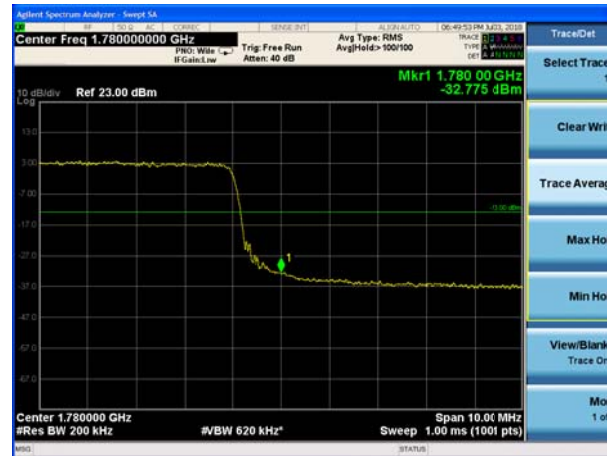



LTE Band 66 16QAM 1.4MHz CH-Low, 1 RB

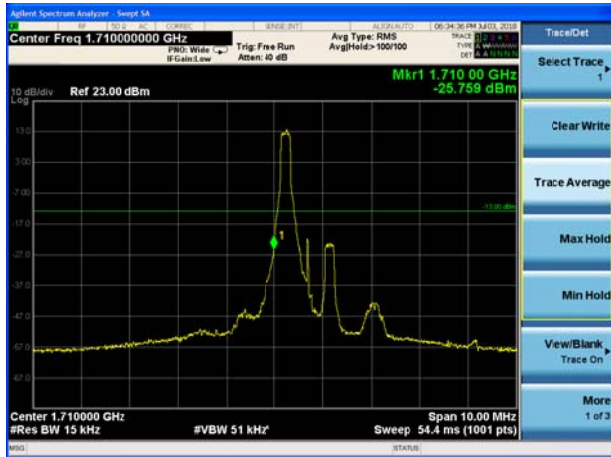

LTE Band 66 16QAM 1.4MHz CH-High, 1 RB

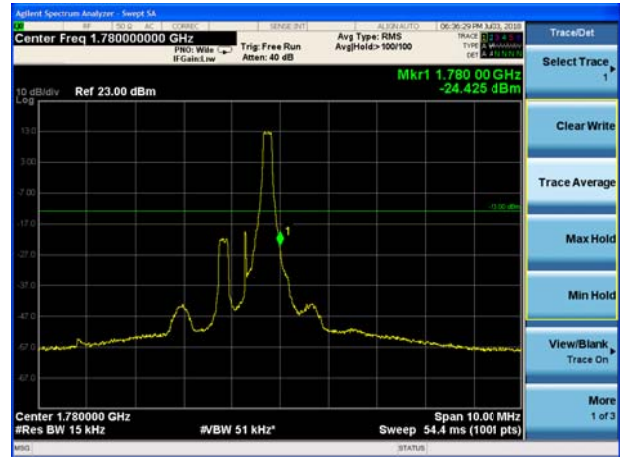

LTE Band 66 16QAM 1.4MHz CH-Low, 100%RB

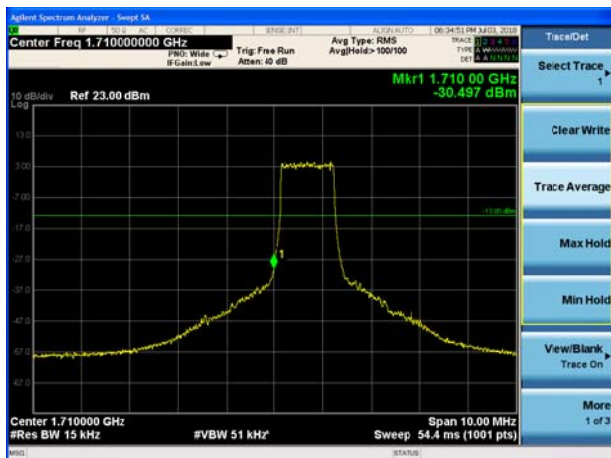

LTE Band 66 16QAM 1.4MHz CH-High, 100%RB

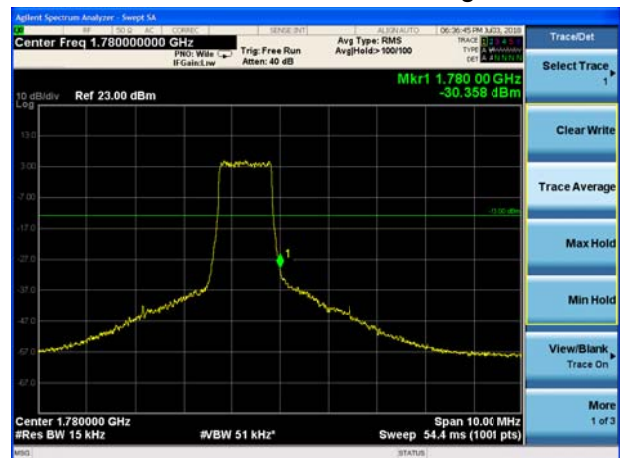

LTE Band 66 16QAM 3MHz CH-Low, 1 RB

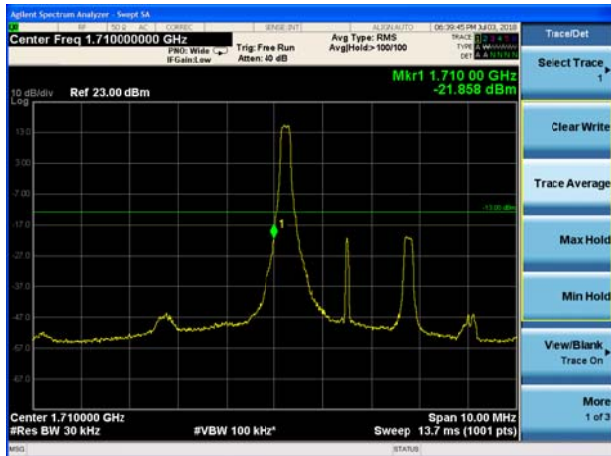

LTE Band 66 16QAM 3MHz CH-High, 1 RB

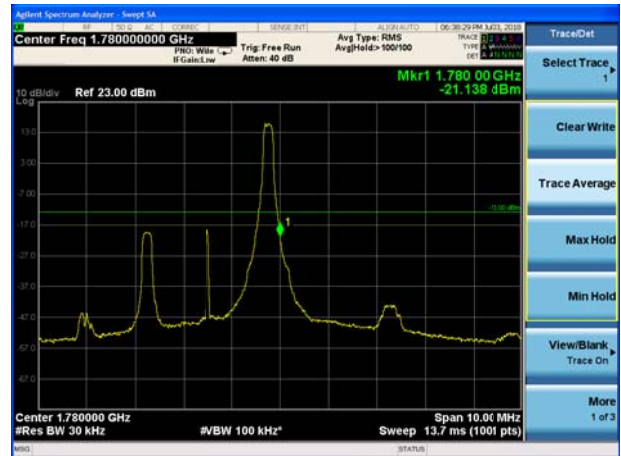



LTE Band 66 16QAM 3MHz CH-Low, 100%RB



LTE Band 66 16QAM 3MHz CH-High, 100%RB



LTE Band 66 16QAM 5MHz CH-Low, 1 RB

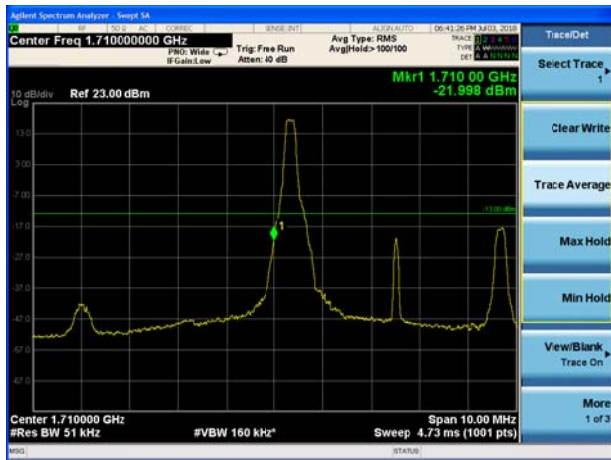

LTE Band 66 16QAM 5MHz CH-High, 1 RB

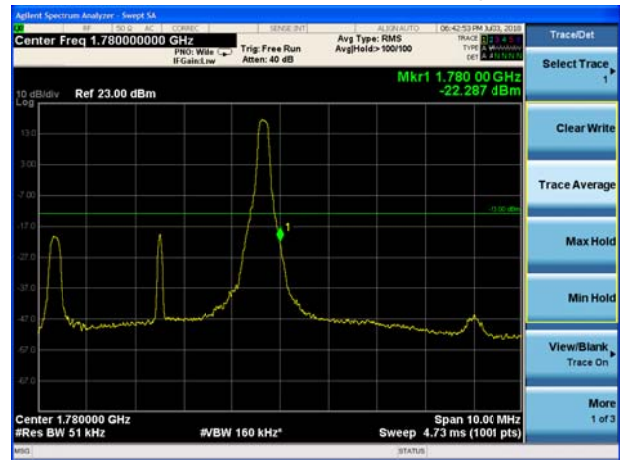

LTE Band 66 16QAM 5MHz CH-Low, 100%RB



LTE Band 66 16QAM 5MHz CH-High, 100%RB





LTE Band 66 16QAM 10MHz CH-Low, 1 RB

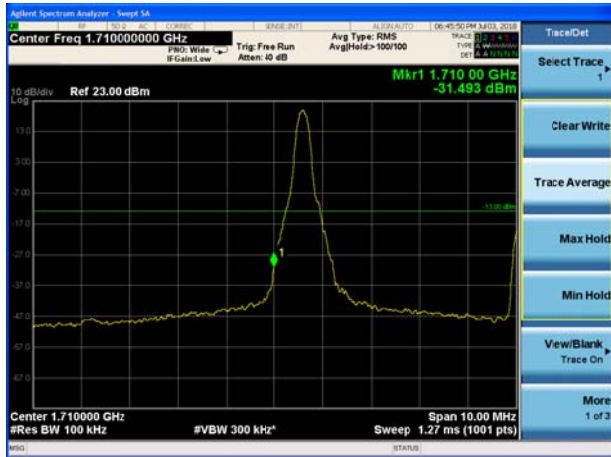

LTE Band 66 16QAM 10MHz CH-High, 1 RB

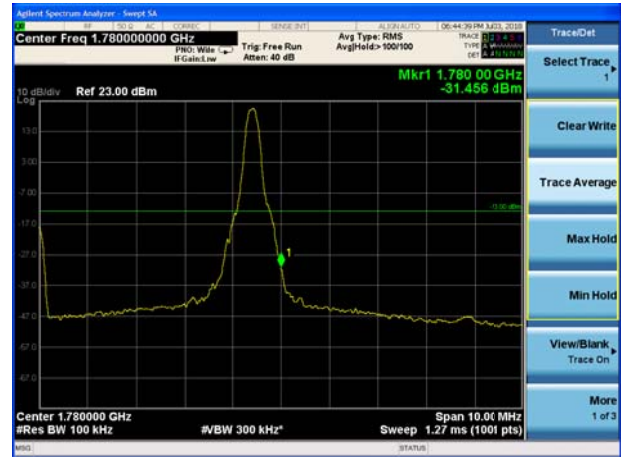

LTE Band 66 16QAM 10MHz CH-Low, 100%RB

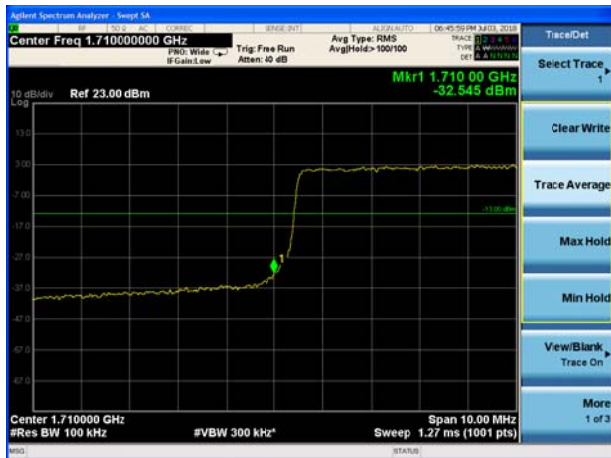

LTE Band 66 16QAM 10MHz CH-High, 100%RB



LTE Band 66 16QAM 15MHz CH-Low, 1 RB

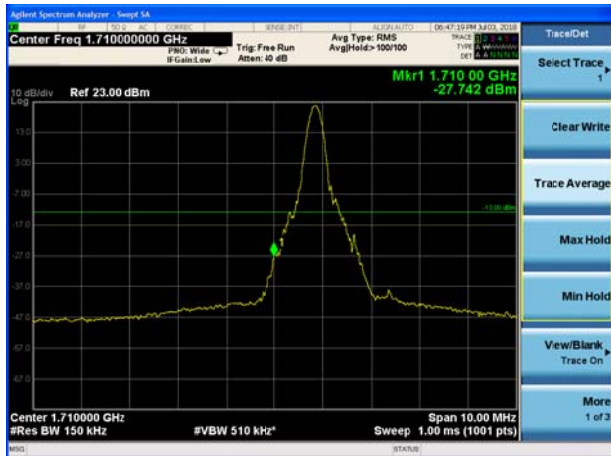

LTE Band 66 16QAM 15MHz CH-High, 1 RB

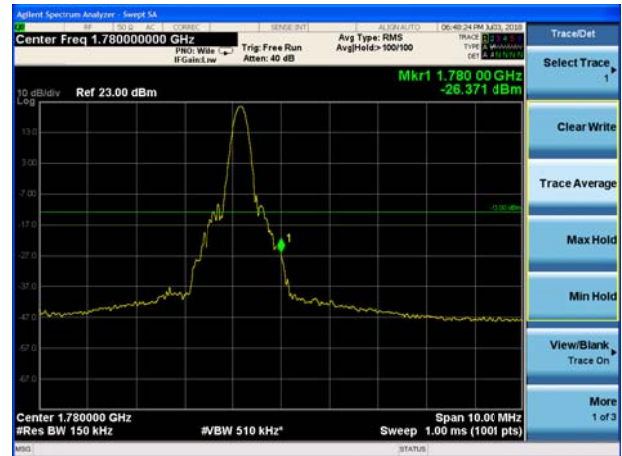



LTE Band 66 16QAM 15MHz CH-Low, 100%RB



LTE Band 66 16QAM 15MHz CH-High, 100%RB



LTE Band 66 16QAM 20MHz CH-Low, 1 RB

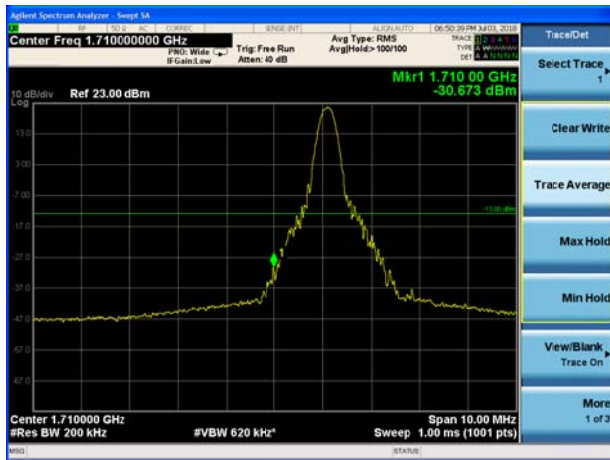

LTE Band 66 16QAM 20MHz CH-High, 1 RB

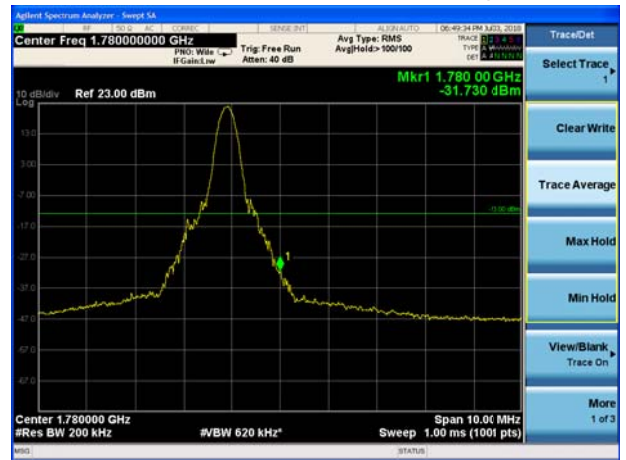

LTE Band 66 16QAM 20MHz CH-Low, 100%RB



LTE Band 66 16QAM 20MHz CH-High, 100%RB



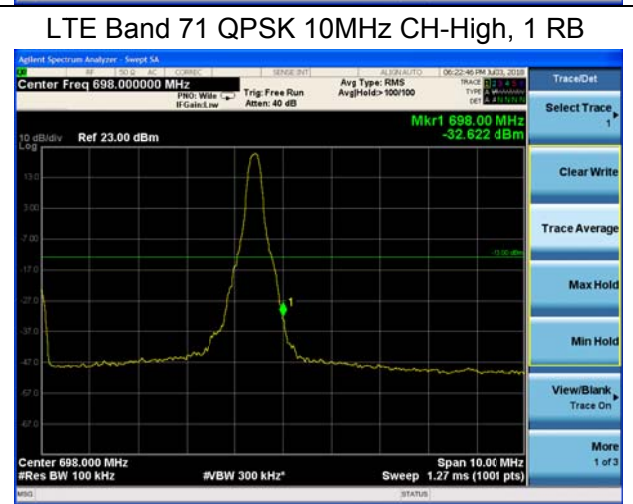
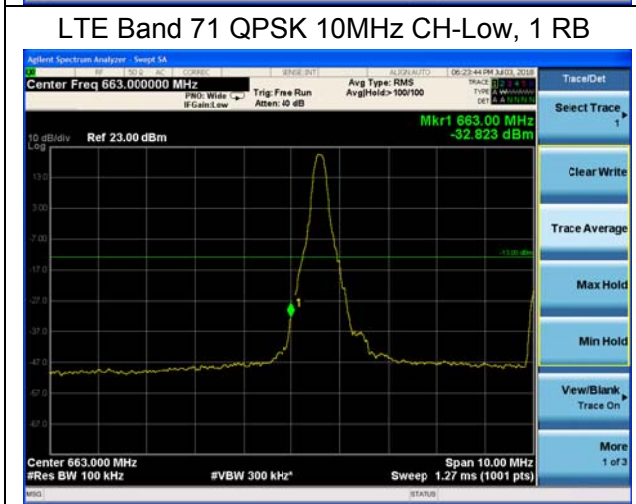
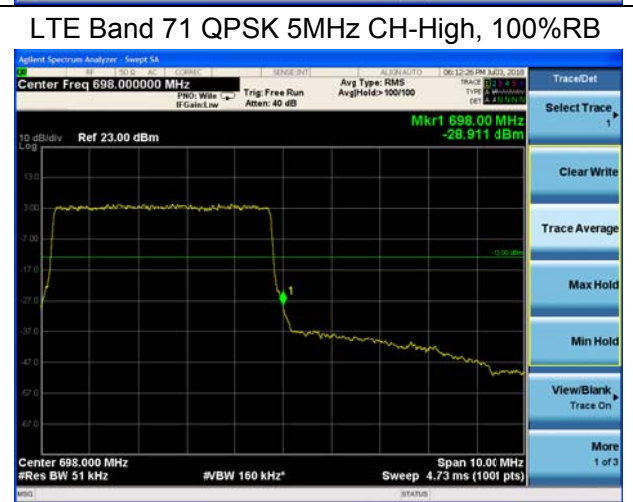
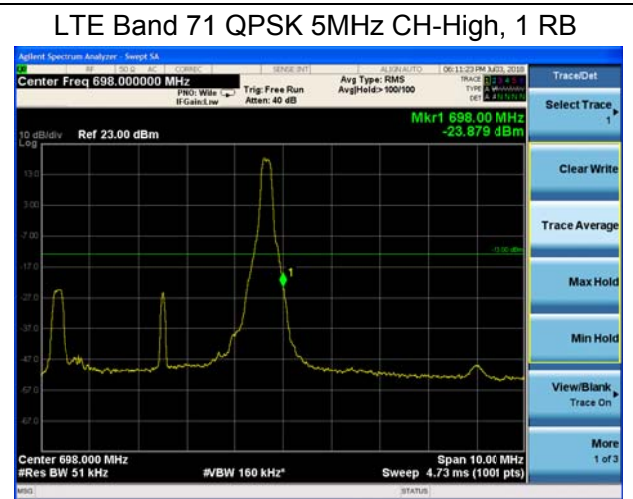
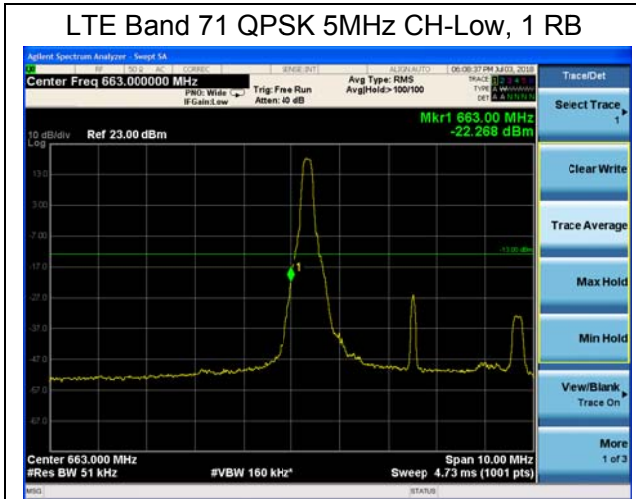





LTE Band 71 QPSK 10MHz CH-Low, 100%RB



LTE Band 71 QPSK 10MHz CH-High, 100%RB



LTE Band 71 QPSK 15MHz CH-Low, 1 RB

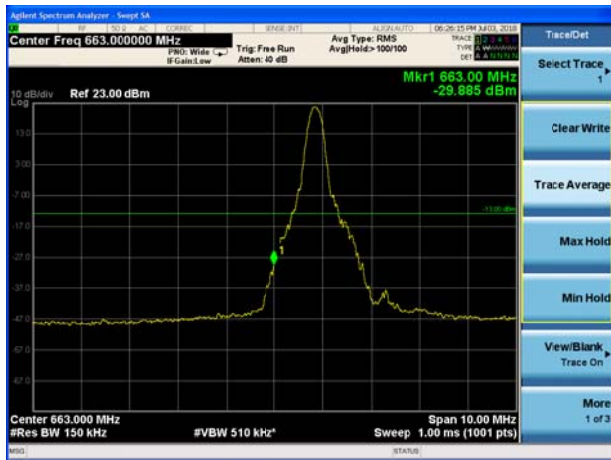

LTE Band 71 QPSK 15MHz CH-High, 1 RB

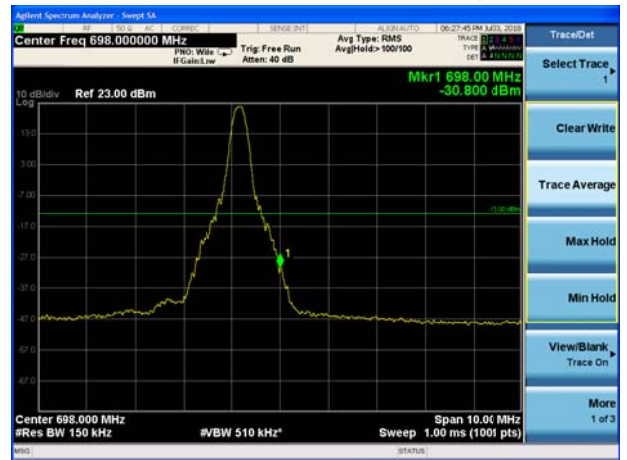

LTE Band 71 QPSK 15MHz CH-Low, 100%RB

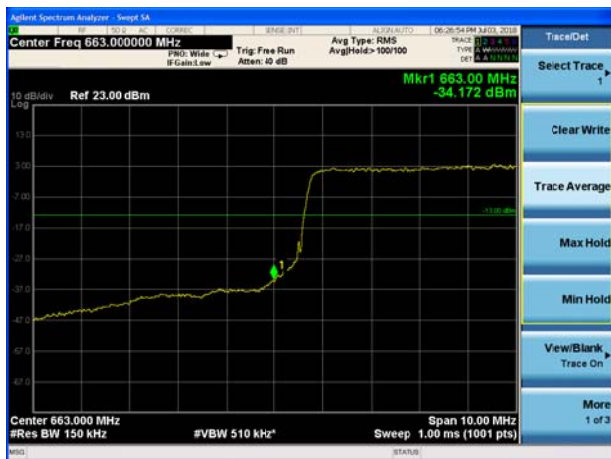

LTE Band 71 QPSK 15MHz CH-High, 100%RB

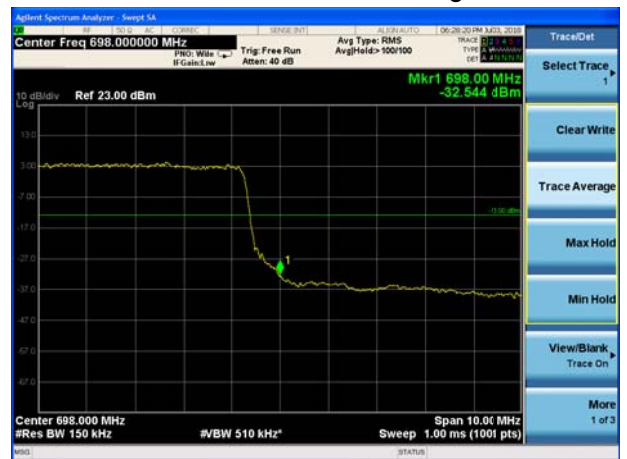



LTE Band 71 QPSK 20MHz CH-Low, 1 RB

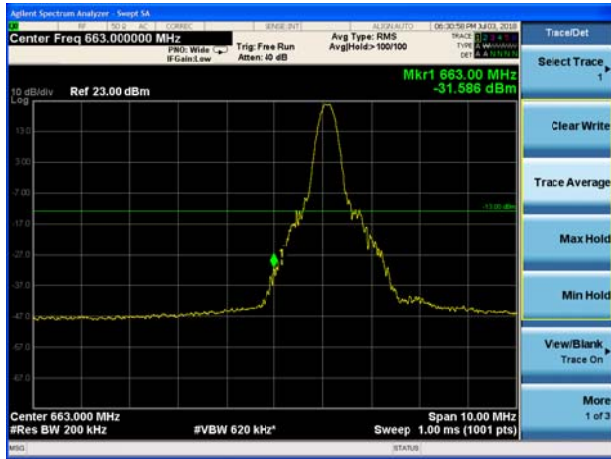

LTE Band 71 QPSK 20MHz CH-High, 1 RB

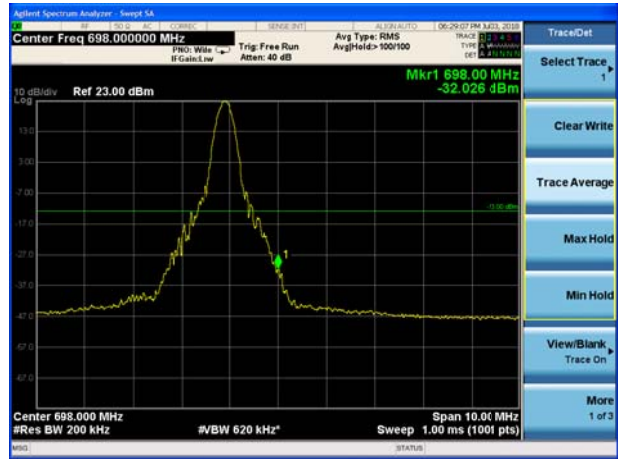

LTE Band 71 QPSK 20MHz CH-Low, 100%RB



LTE Band 71 QPSK 20MHz CH-High, 100%RB



LTE Band 71 16QAM 5MHz CH-Low, 1 RB

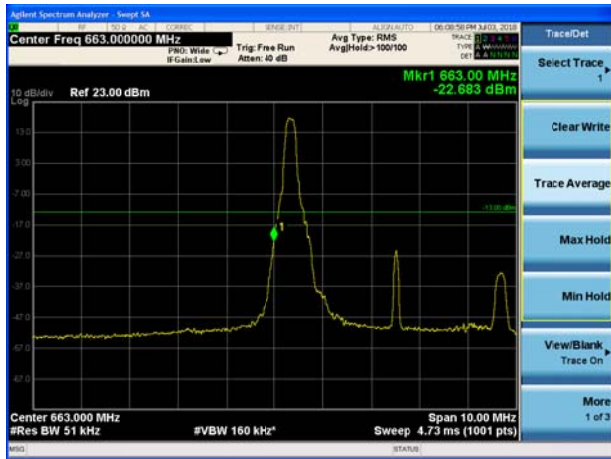

LTE Band 71 16QAM 5MHz CH-High, 1 RB

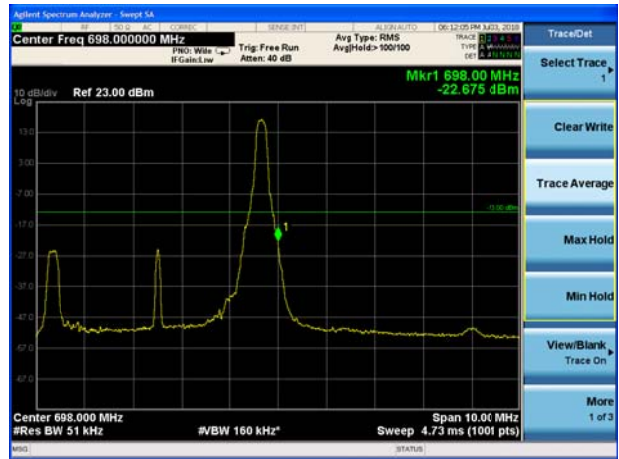



LTE Band 71 16QAM 5MHz CH-Low, 100%RB



LTE Band 71 16QAM 5MHz CH-High, 100%RB



LTE Band 71 16QAM 10MHz CH-Low, 1 RB

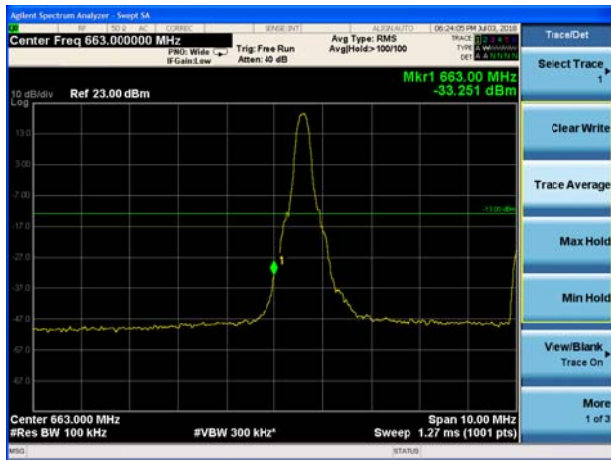

LTE Band 71 16QAM 10MHz CH-High, 1 RB

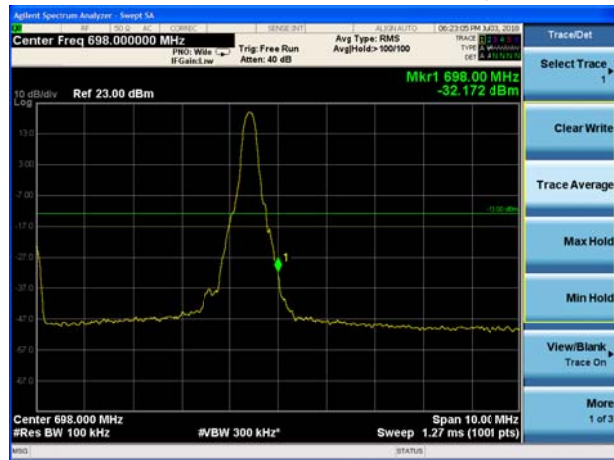

LTE Band 71 16QAM 10MHz CH-Low, 100%RB



LTE Band 71 16QAM 10MHz CH-High, 100%RB





LTE Band 71 16QAM 15MHz CH-Low, 1 RB

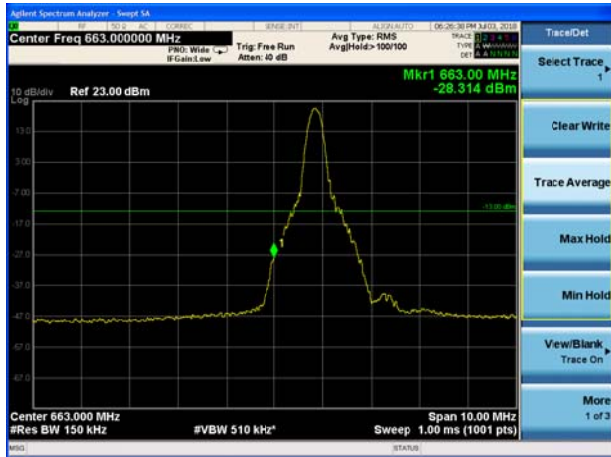

LTE Band 71 16QAM 15MHz CH-High, 1 RB

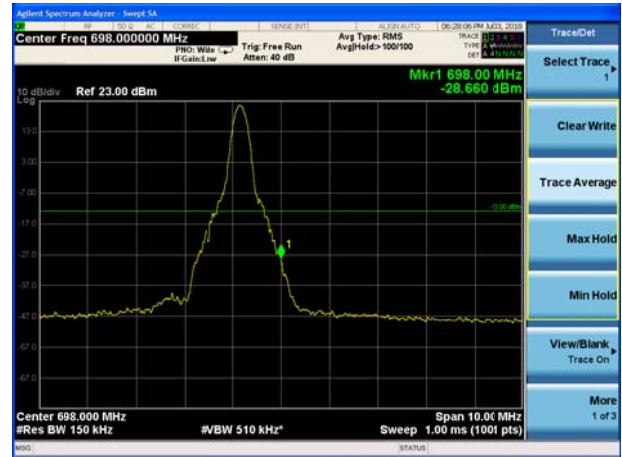

LTE Band 71 16QAM 15MHz CH-Low, 100%RB



LTE Band 71 16QAM 15MHz CH-High, 100%RB



LTE Band 71 16QAM 20MHz CH-Low, 1 RB

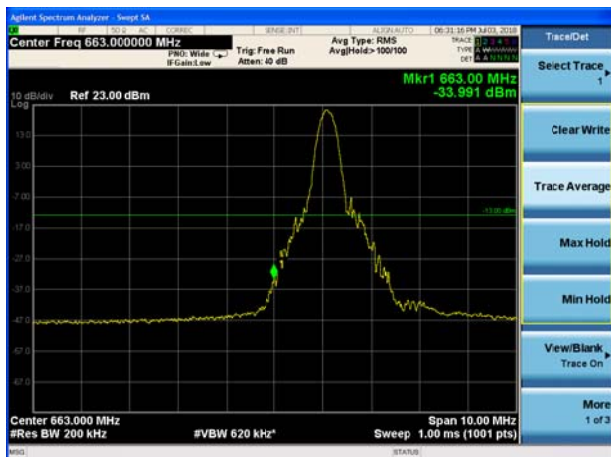

LTE Band 71 16QAM 20MHz CH-High, 1 RB

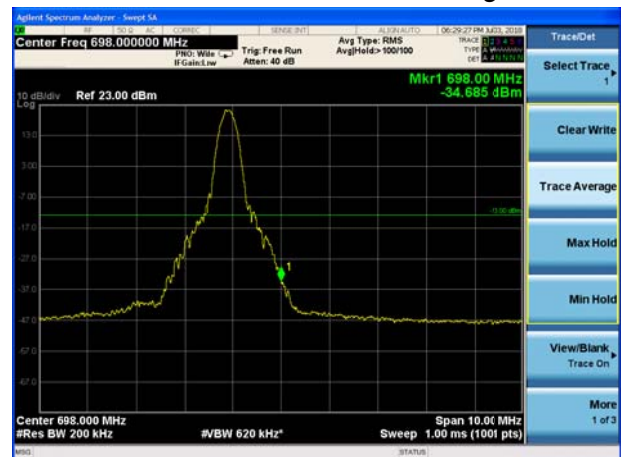



LTE Band 71 16QAM 20MHz CH-Low, 100%RB

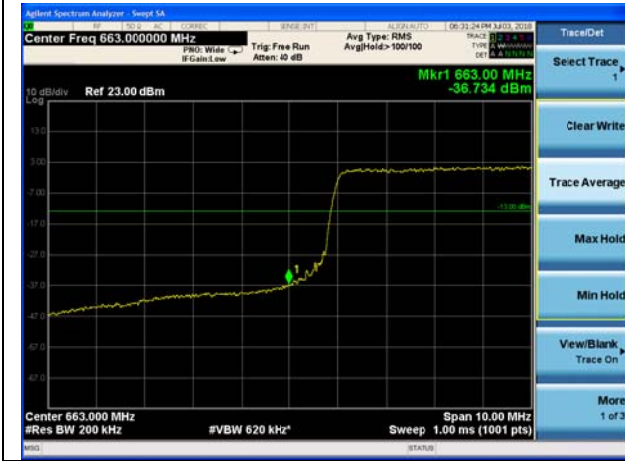

LTE Band 71 16QAM 20MHz CH-High, 100%RB



### 5.5 Peak-to-Average Power Ratio (PAPR)

#### Ambient condition

Temperature	Relative humidity	Pressure
23°C ~25°C	45%~50%	101.5kPa

#### Methods of Measurement

Measure the total peak power and record as PPk. And measure the total average power and record as PAvg. Both the peak and average power levels must be expressed in the same logarithmic units (e.g., dBm). Determine the PAPR from:

$$PAPR (dB) = PPk (dBm) - PAvg (dBm).$$

#### Test Setup

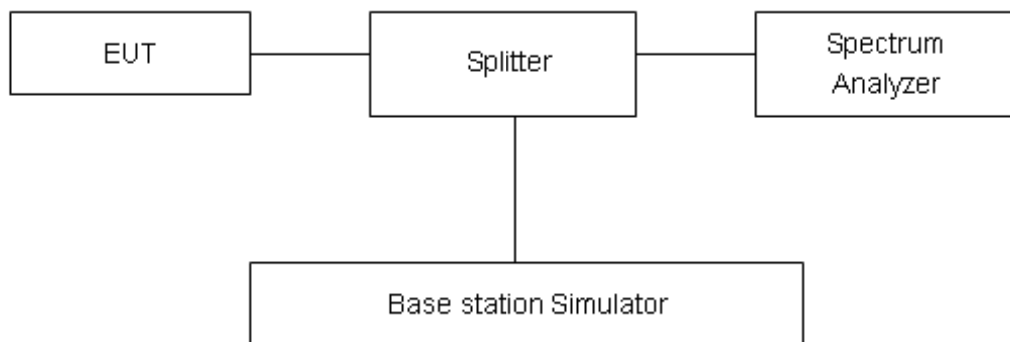

#### Limits

Rule Part 27.50(d)(5) Equipment employed must be authorized in accordance with the provisions of 24.51. Power measurements for transmissions by stations authorized under this section may be made either in accordance with a Commission-approved average power technique or in compliance with paragraph (d)(6) of this section. In measuring transmissions in this band using an average power technique, the peak-to-average ratio (PAR) of the transmission may not exceed 13 dB.

#### Measurement Uncertainty

The assessed measurement uncertainty to ensure 95% confidence level for the normal distribution is with the coverage factor k = 2, U= 0.4 dB.

**Test Results**

WCDMA Band IV	Channel	Frequency (MHz)	Peak (dBm)	Avg (dBm)	PAPR (dB)	Limit (dB)	Conclusion
<b>RMC</b>	1312	1712.4	26.51	23.46	3.05	≤13	PASS
	1413	1732.6	26.30	23.35	2.95	≤13	PASS
	1513	1752.6	26.19	23.37	2.82	≤13	PASS

<b>LTE Band 4</b>								
Modulation	Bandwidth (MHz)	Channel	Frequency (MHz)	Peak (dBm)	Avg (dBm)	PAPR (dB)	Limit (dB)	Conclusion
<b>QPSK</b>	1.4	19957	1710.7	27.15	22.30	4.85	≤13	PASS
		20175	1732.5	27.21	22.40	4.81	≤13	PASS
		20393	1754.3	27.12	22.64	4.48	≤13	PASS
	3	19965	1711.5	27.30	22.33	4.97	≤13	PASS
		20175	1732.5	27.37	22.44	4.93	≤13	PASS
		20385	1753.5	27.37	22.67	4.70	≤13	PASS
	5	19975	1712.5	27.31	22.31	5.00	≤13	PASS
		20175	1732.5	27.33	22.43	4.90	≤13	PASS
		20375	1752.5	27.29	22.65	4.64	≤13	PASS
	10	20000	1715	27.34	22.39	4.95	≤13	PASS
		20175	1732.5	27.28	22.45	4.83	≤13	PASS
		20350	1750	27.31	22.69	4.62	≤13	PASS
	15	20025	1717.5	27.40	22.37	5.03	≤13	PASS
		20175	1732.5	27.27	22.41	4.86	≤13	PASS
		20325	1747.5	27.20	22.64	4.56	≤13	PASS
	20	20050	1720	27.26	22.34	4.92	≤13	PASS
		20175	1732.5	27.14	22.36	4.78	≤13	PASS
		20300	1745	27.23	22.60	4.63	≤13	PASS
<b>16QAM</b>	1.4	19957	1710.7	27.03	21.34	5.69	≤13	PASS
		20175	1732.5	27.07	21.48	5.59	≤13	PASS
		20393	1754.3	26.99	21.68	5.31	≤13	PASS
	3	19965	1711.5	27.15	21.37	5.78	≤13	PASS
		20175	1732.5	27.21	21.52	5.69	≤13	PASS
		20385	1753.5	27.21	21.71	5.50	≤13	PASS
	5	19975	1712.5	27.11	21.35	5.76	≤13	PASS
		20175	1732.5	27.16	21.48	5.68	≤13	PASS
		20375	1752.5	27.05	21.66	5.39	≤13	PASS
	10	20000	1715	27.14	21.38	5.76	≤13	PASS
		20175	1732.5	27.18	21.53	5.65	≤13	PASS
		20350	1750	27.14	21.70	5.44	≤13	PASS



	15	20025	1717.5	27.12	21.35	5.77	≤13	PASS
		20175	1732.5	27.08	21.48	5.60	≤13	PASS
		20325	1747.5	26.95	21.66	5.29	≤13	PASS
	20	20050	1720	27.04	21.33	5.71	≤13	PASS
		20175	1732.5	27.03	21.44	5.59	≤13	PASS
		20300	1745	27.03	21.63	5.40	≤13	PASS

LTE Band 12								
Modulation	Bandwidth (MHz)	Channel	Frequency (MHz)	Peak (dBm)	Avg (dBm)	PAPR (dB)	Limit (dB)	Conclusion
QPSK	1.4	23017	699.7	27.71	22.61	5.10	≤13	PASS
		23095	707.5	27.72	22.57	5.15	≤13	PASS
		23173	715.3	27.70	22.65	5.05	≤13	PASS
	3	23025	700.5	27.83	22.64	5.19	≤13	PASS
		23095	707.5	27.82	22.61	5.21	≤13	PASS
		23165	714.5	27.87	22.68	5.19	≤13	PASS
	5	23035	701.5	27.87	22.68	5.19	≤13	PASS
		23095	707.5	27.75	22.58	5.17	≤13	PASS
		23155	713.5	27.86	22.65	5.21	≤13	PASS
	10	23060	704	27.83	22.65	5.18	≤13	PASS
		23095	707.5	27.60	22.53	5.07	≤13	PASS
		23130	711	27.76	22.61	5.15	≤13	PASS
16QAM	1.4	23017	699.7	27.73	21.71	6.02	≤13	PASS
		23095	707.5	27.57	21.63	5.94	≤13	PASS
		23173	715.3	27.73	21.84	5.89	≤13	PASS
	3	23025	700.5	27.78	21.74	6.04	≤13	PASS
		23095	707.5	27.71	21.67	6.04	≤13	PASS
		23165	714.5	27.89	21.87	6.02	≤13	PASS
	5	23035	701.5	27.70	21.72	5.98	≤13	PASS
		23095	707.5	27.59	21.63	5.96	≤13	PASS
		23155	713.5	27.81	21.82	5.99	≤13	PASS
	10	23060	704	27.68	21.70	5.98	≤13	PASS
		23095	707.5	27.50	21.59	5.91	≤13	PASS
		23130	711	27.76	21.79	5.97	≤13	PASS

LTE Band 13								
Modulation	Bandwidth (MHz)	Channel	Frequency (MHz)	Peak (dBm)	Avg (dBm)	PAPR (dB)	Limit (dB)	Conclusion
QPSK	5	23205	779.5	27.81	22.81	5.00	≤13	PASS





16QAM	10	23230	782	27.79	22.74	5.05	≤13	PASS
		23255	784.5	27.89	22.80	5.09	≤13	PASS
		23230	782	27.75	22.74	5.01	≤13	PASS
	5	23205	779.5	27.57	21.74	5.83	≤13	PASS
		23230	782	27.81	21.96	5.85	≤13	PASS
		23255	784.5	27.47	21.62	5.85	≤13	PASS
10	23230	782	27.65	21.82	5.83	≤13	PASS	

LTE Band 66								
Modulation	Bandwidth (MHz)	Channel	Frequency (MHz)	Peak (dBm)	Avg (dBm)	PAPR (dB)	Limit (dB)	Conclusion
QPSK	1.4	131979	1710.7	27.40	22.51	4.89	≤13	PASS
		132322	1745	27.22	22.73	4.49	≤13	PASS
		132665	1779.3	27.31	22.34	4.97	≤13	PASS
	3	131987	1711.5	27.51	22.54	4.97	≤13	PASS
		132322	1745	27.47	22.77	4.70	≤13	PASS
		132657	1778.5	27.48	22.37	5.11	≤13	PASS
	5	131997	1712.5	27.52	22.52	5.00	≤13	PASS
		132322	1745	27.40	22.76	4.64	≤13	PASS
		132647	1777.5	27.38	22.35	5.03	≤13	PASS
	10	132022	1715	27.54	22.60	4.94	≤13	PASS
		132322	1745	27.34	22.78	4.56	≤13	PASS
		132622	1775	27.37	22.39	4.98	≤13	PASS
	15	132047	1717.5	27.57	22.58	4.99	≤13	PASS
		132322	1745	27.25	22.74	4.51	≤13	PASS
		132597	1772.5	27.36	22.34	5.02	≤13	PASS
	20	132072	1720	27.46	22.55	4.91	≤13	PASS
		132322	1745	27.25	22.69	4.56	≤13	PASS
		132572	1770	27.21	22.30	4.91	≤13	PASS
16QAM	1.4	131979	1710.7	27.34	21.65	5.69	≤13	PASS
		132322	1745	27.08	21.84	5.24	≤13	PASS
		132665	1779.3	27.26	21.45	5.81	≤13	PASS
	3	131987	1711.5	27.44	21.68	5.76	≤13	PASS
		132322	1745	27.35	21.88	5.47	≤13	PASS
		132657	1778.5	27.37	21.48	5.89	≤13	PASS
	5	131997	1712.5	27.41	21.66	5.75	≤13	PASS
		132322	1745	27.20	21.84	5.36	≤13	PASS
		132647	1777.5	27.23	21.43	5.80	≤13	PASS



	10	132022	1715	27.48	21.69	5.79	≤13	PASS
		132322	1745	27.25	21.89	5.36	≤13	PASS
		132622	1775	27.28	21.47	5.81	≤13	PASS
	15	132047	1717.5	27.39	21.66	5.73	≤13	PASS
		132322	1745	27.08	21.84	5.24	≤13	PASS
		132597	1772.5	27.17	21.43	5.74	≤13	PASS
	20	132072	1720	27.33	21.64	5.69	≤13	PASS
		132322	1745	27.16	21.80	5.36	≤13	PASS
		132572	1770	27.10	21.40	5.70	≤13	PASS

LTE Band 71								
Modulation	Bandwidth (MHz)	Channel	Frequency (MHz)	Peak (dBm)	Avg (dBm)	PAPR (dB)	Limit (dB)	Conclusion
	5	133147	665.5	27.25	22.17	5.08	≤13	PASS
		133297	680.5	27.48	22.40	5.08	≤13	PASS
		133447	695.5	27.35	22.20	5.15	≤13	PASS
	10	133172	668	27.33	22.25	5.08	≤13	PASS
		133297	680.5	27.47	22.42	5.05	≤13	PASS
		133422	693	27.31	22.24	5.07	≤13	PASS
	15	133197	670.5	27.45	22.23	5.22	≤13	PASS
		133297	680.5	27.28	22.11	5.17	≤13	PASS
		133397	690.5	27.40	22.19	5.21	≤13	PASS
	20	133222	673	27.24	22.20	5.04	≤13	PASS
		133322	683	27.36	22.33	5.03	≤13	PASS
		133372	688	27.23	22.15	5.08	≤13	PASS
	5	133147	665.5	27.14	21.32	5.82	≤13	PASS
		133297	680.5	27.36	21.50	5.86	≤13	PASS
		133447	695.5	27.22	21.31	5.91	≤13	PASS
	10	133172	668	27.22	21.35	5.87	≤13	PASS
		133297	680.5	27.37	21.55	5.82	≤13	PASS
		133422	693	27.24	21.35	5.89	≤13	PASS
	15	133197	670.5	27.25	21.32	5.93	≤13	PASS
		133297	680.5	26.98	21.11	5.87	≤13	PASS
		133397	690.5	27.25	21.31	5.94	≤13	PASS
	20	133222	673	27.16	21.30	5.86	≤13	PASS
		133322	683	27.29	21.46	5.83	≤13	PASS
		133372	688	27.16	21.28	5.88	≤13	PASS

## 5.6 Frequency Stability

### Ambient condition

Temperature	Relative humidity	Pressure
23°C ~25°C	45%~50%	101.5kPa

### Method of Measurement

#### Frequency Stability (Temperature Variation)

The temperature inside the climate chamber is varied from -40°C to +85°C in 10°C step size.

(1) With all power removed, the temperature was decreased to -10°C and permitted to stabilize for three hours.

(2) Measure the carrier frequency with the test equipment in a “call mode”. These measurements should be made within 1 minute of powering up the mobile station, to prevent significant self warming.

(3) Repeat the above measurements at 10°C increments from -40°C to +85°C. Allow at least 1.5 hours at each temperature, un-powered, before making measurements.

#### Frequency Stability (Voltage Variation)

The frequency stability shall be measured with variation of primary supply voltage as follows:

(1) Vary primary supply voltage from 85 to 115 percent of the nominal value for other than hand carried battery equipment.

(2) For hand carried, battery powered equipment, reduce primary supply voltage to the battery-operating end point which shall be specified by the manufacturer.

This transceiver is specified to operate with an input voltage of between 3.3 V and 4.3 V, with a nominal voltage of 3.8V.

### Test setup

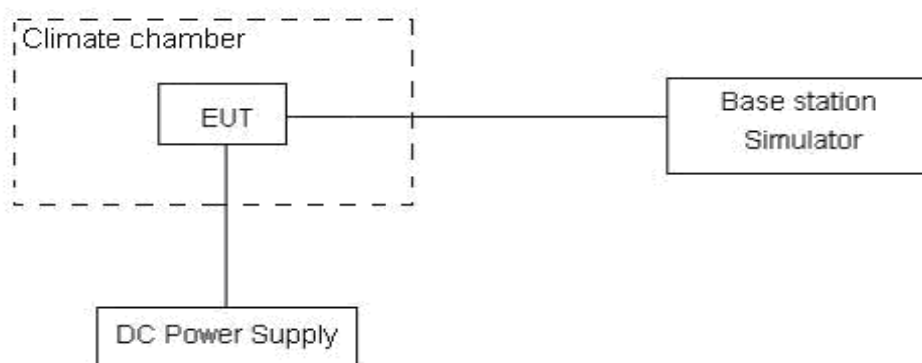

### Limits

No specific frequency stability requirements in part 27.54

### Measurement Uncertainty

The assessed measurement uncertainty to ensure 99.75% confidence level for the normal distribution is with the coverage factor  $k = 3, U=0.01\text{ppm}$ .

**Test Result**

WCDMA Band IV

WCDMA Band IV					
Condition		1710	1755	Delta(Hz)	Frequency Stability(ppm)
Temperature	Voltage	F low@-13dBm(MHz)	F high@-13dBm(MHz)		
Normal (25°C)	Normal	1710.0279	1754.9113	2.13	0.00113
Extreme (85°C)		1710.0281	1754.9112	-3.16	-0.00168
Extreme (80°C)		1710.0276	1754.9116	0.59	0.00031
Extreme (70°C)		1710.0291	1754.9101	-5.54	-0.00295
Extreme (60°C)		1710.0272	1754.9122	-1.17	-0.00062
Extreme (50°C)		1710.0269	1754.9123	0.16	0.00009
Extreme (40°C)		1710.0284	1754.9108	-5.52	-0.00294
Extreme (30°C)		1710.0273	1754.9119	-3.36	-0.00179
Extreme (20°C)		1710.0271	1754.9122	0.69	0.00037
Extreme (10C)		1710.0286	1754.9106	0.89	0.00047
Extreme (0°C)		1710.0277	1754.9115	3.19	0.00170
Extreme (-10°C)		1710.0291	1754.9122	0.39	0.00021
Extreme (-20°C)		1710.0323	1754.9153	3.56	0.00189
Extreme (-30°C)		1710.0339	1754.9175	0.19	0.00010
Extreme (-40°C)		1710.0345	1754.9187	2.80	0.00149
25C	LV	1710.0316	1754.9147	2.96	0.00157
	HV	1710.0303	1754.9156	0.49	0.00026

LTE Band 4					
(QPSK, 20MHz BANDWIDTH)					
Condition		1710	1755	Delta(Hz)	Frequency Stability(ppm)
Temperature	Voltage	F low@-13dBm(MHz)	F high@-13dBm(MHz)		
Normal (25°C)	Normal	1710.6538	1754.4302	1.44	0.00083
Extreme (85°C)		1710.6549	1754.4314	0.86	0.00050
Extreme (80°C)		1710.6516	1754.4275	-2.69	-0.00155
Extreme (70°C)		1710.6529	1754.4294	-1.82	-0.00105
Extreme (60°C)		1710.6515	1754.4285	2.10	0.00121
Extreme (50°C)		1710.6521	1754.4286	0.86	0.00050
Extreme (40°C)		1710.6534	1754.4299	-0.07	-0.00004
Extreme (30°C)		1710.6541	1754.4306	0.35	0.00020
Extreme (20°C)		1710.6523	1754.4285	-0.40	-0.00023
Extreme (10C)		1710.6532	1754.4297	-0.20	-0.00012
Extreme (0°C)		1710.6519	1754.4284	0.56	0.00032



Extreme (-10°C)		1710.6514	1754.4279	-2.60	-0.00150
Extreme (-20°C)		1710.6525	1754.4291	-0.42	-0.00024
Extreme (-30°C)		1710.6558	1754.4323	1.26	0.00073
Extreme (-40°C)		1710.6576	1754.4335	3.50	0.00202
25°C	LV	1710.6522	1754.4287	-1.15	-0.00066
	HV	1710.6528	1754.4293	0.97	0.00056
(16QAM, 20MHz BANDWIDTH)					
Condition		1710	1755	Delta(Hz)	Frequency Stability(ppm)
Temperature	Voltage	F low@-13dBm(MHz)	F high@-13dBm(MHz)		
Normal (25°C)	Normal	1710.6387	1754.5105	-6.99	-0.00403
Extreme (85°C)		1710.6369	1754.5094	3.06	0.00177
Extreme (80°C)		1710.6408	1754.5133	-3.56	-0.00205
Extreme (70°C)		1710.6389	1754.5114	-5.22	-0.00301
Extreme (60°C)		1710.6403	1754.5128	-3.92	-0.00226
Extreme (50°C)		1710.6397	1754.5122	-2.16	-0.00125
Extreme (40°C)		1710.6384	1754.5109	-2.64	-0.00152
Extreme (30°C)		1710.6377	1754.5102	0.55	0.00032
Extreme (20°C)		1710.6398	1754.5123	0.33	0.00019
Extreme (10C)		1710.6386	1754.5111	-2.00	-0.00115
Extreme (0°C)		1710.6399	1754.5124	0.06	0.00003
Extreme (-10°C)		1710.6404	1754.5129	4.07	0.00235
Extreme (-20°C)		1710.6393	1754.5118	-0.53	-0.00031
Extreme (-30°C)		1710.6363	1754.5085	2.99	0.00173
Extreme (-40°C)			1710.6348	1754.5073	0.55
25°C	LV	1710.6396	1754.5121	0.15	0.00009
	HV	1710.6391	1754.5115	3.19	0.00184

LTE Band 12					
(QPSK, 10MHz BANDWIDTH)					
Condition		699	716	Delta(Hz)	Frequency Stability(ppm)
Temperature	Voltage	F low@-13dBm(MHz)	F high@-13dBm(MHz)		
Normal (25°C)	Normal	699.2572	715.7323	-0.91	-0.00109
Extreme (85°C)		699.2583	715.7311	-3.35	-0.00400
Extreme (80°C)		699.2544	715.7272	-3.47	-0.00415
Extreme (70°C)		699.2563	715.7291	-6.40	-0.00765
Extreme (60°C)		699.2549	715.7277	-5.64	-0.00674
Extreme (50°C)		699.2555	715.7283	-0.38	-0.00045
Extreme (40°C)		699.2568	715.7296	-1.02	-0.00122
Extreme (30°C)		699.2575	715.7303	-1.09	-0.00130



Extreme (20°C)		699.2554	715.7282	3.16	0.00378
Extreme (10C)		699.2566	715.7294	1.15	0.00137
Extreme (0°C)		699.2553	715.7281	-3.64	-0.00435
Extreme (-10°C)		699.2548	715.7276	-4.34	-0.00519
Extreme (-20°C)		699.2559	715.7287	-0.35	-0.00042
Extreme (-30°C)		699.2592	715.7324	2.28	0.00273
Extreme (-40°C)		699.2604	715.7332	-3.92	-0.00469
25°C	LV	699.2556	715.7284	-5.58	-0.00667
	HV	699.2562	715.7295	0.20	0.00024
(16QAM, 10MHz BANDWIDTH)					
Condition		699	716	Delta(Hz)	Frequency Stability(ppm)
Temperature	Voltage	F low@-13dBm(MHz)	F high@-13dBm(MHz)		
Normal (25°C)	Normal	699.3118	715.6805	0.85	0.00102
Extreme (85°C)		699.3107	715.6794	-0.85	-0.00102
Extreme (80°C)		699.3146	715.6833	-0.21	-0.00025
Extreme (70°C)		699.3127	715.6814	-1.63	-0.00195
Extreme (60°C)		699.3141	715.6828	-1.10	-0.00132
Extreme (50°C)		699.3135	715.6822	0.86	0.00103
Extreme (40°C)		699.3122	715.6809	-1.34	-0.00160
Extreme (30°C)		699.3115	715.6802	-3.09	-0.00369
Extreme (20°C)		699.3136	715.6823	-2.91	-0.00348
Extreme (10C)		699.3124	715.6811	-2.10	-0.00251
Extreme (0°C)		699.3137	715.6824	0.08	0.00010
Extreme (-10°C)		699.3142	715.6829	2.56	0.00306
Extreme (-20°C)		699.3131	715.6818	-1.21	-0.00145
Extreme (-30°C)		699.3098	715.6785	-1.31	-0.00157
Extreme (-40°C)		699.3086	715.6773	0.69	0.00082
25°C	LV	699.3134	715.6821	3.45	0.00412
	HV	699.3128	715.6815	4.51	0.00539

LTE Band 13					
(QPSK, 10MHz BANDWIDTH)					
Condition		777	787	Delta(Hz)	Frequency Stability(ppm)
Temperature	Voltage	F low@-13dBm(MHz)	F high@-13dBm(MHz)		
Normal (25°C)	Normal	777.4363	786.5756	2.53	0.00302
Extreme (85°C)		777.4364	786.5755	-5.60	-0.00669
Extreme (80°C)		777.4360	786.5759	12.94	0.01547
Extreme (70°C)		777.4375	786.5744	-4.47	-0.00534
Extreme (60°C)		777.4356	786.5763	0.11	0.00013



Extreme (50°C)		777.4353	786.5766	0.59	0.00071
Extreme (40°C)		777.4368	786.5751	-0.47	-0.00056
Extreme (30°C)		777.4357	786.5762	3.15	0.00377
Extreme (20°C)		777.4354	786.5765	6.52	0.00779
Extreme (10C)		777.4370	786.5749	5.15	0.00616
Extreme (0°C)		777.4361	786.5758	1.84	0.00220
Extreme (-10°C)		777.4356	786.5751	-0.64	-0.00077
Extreme (-20°C)		777.4362	786.5765	-1.12	-0.00134
Extreme (-30°C)		777.4356	786.5763	-1.60	-0.00191
Extreme (-40°C)		777.4362	786.5757	-3.90	-0.00466
25°C	LV	777.4356	786.5755	5.91	0.00707
	HV	777.4362	786.5744	3.58	0.00428
(16QAM, 10MHz BANDWIDTH)					
Condition		777	787	Delta(Hz)	Frequency Stability(ppm)
Temperature	Voltage	F low@-13dBm(MHz)	F high@-13dBm(MHz)		
Normal (25°C)	Normal	777.5179	786.5012	-11.34	-0.01356
Extreme (85°C)		777.5180	786.5011	7.20	0.00861
Extreme (80°C)		777.5176	786.5015	-10.21	-0.01221
Extreme (70°C)		777.5191	786.5131	-5.63	-0.00673
Extreme (60°C)		777.5172	786.5019	-5.15	-0.00616
Extreme (50°C)		777.5169	786.5022	-6.21	-0.00742
Extreme (40°C)		777.5184	786.5007	-2.59	-0.00310
Extreme (30°C)		777.5173	786.5018	0.78	0.00093
Extreme (20°C)		777.5170	786.5021	-0.59	-0.00071
Extreme (10C)		777.5186	786.5005	-3.90	-0.00466
Extreme (0°C)		777.5177	786.5014	-6.38	-0.00763
Extreme (-10°C)		777.5176	786.5011	-6.86	-0.00820
Extreme (-20°C)		777.5169	786.5131	-7.34	-0.00877
Extreme (-30°C)		777.5173	786.5018	-9.64	-0.01152
Extreme (-40°C)			777.5186	786.5005	0.17
25°C	LV	777.5172	786.5019	-7.34	-0.00877
	HV	777.5178	786.5013	-2.76	-0.00330

LTE Band 66					
(QPSK, 20MHz BANDWIDTH)					
Condition		1710	1780	Delta(Hz)	Frequency Stability(ppm)
Temperature	Voltage	F low@-13dBm(MHz)	F high@-13dBm(MHz)		
Normal (25°C)	Normal	1710.3406	1779.6709	3.51	0.00201
Extreme (85°C)		1710.3405	1779.6708	4.90	0.00281
Extreme (80°C)		1710.3403	1779.6703	-2.65	-0.00152
Extreme (70°C)		1710.3421	1779.6723	-1.64	-0.00094
Extreme (60°C)		1710.3418	1779.6721	3.59	0.00206
Extreme (50°C)		1710.3409	1779.6712	-7.62	-0.00437
Extreme (40°C)		1710.3394	1779.6697	-2.49	-0.00143
Extreme (30°C)		1710.3413	1779.6716	-1.06	-0.00061
Extreme (20°C)		1710.3416	1779.6719	6.30	0.00361
Extreme (10C)		1710.3401	1779.6704	-9.93	-0.00569
Extreme (0°C)		1710.3412	1779.6715	5.59	0.00320
Extreme (-10°C)		1710.3415	1779.6718	3.51	0.00201
Extreme (-20°C)		1710.3399	1779.6702	-9.02	-0.00517
Extreme (-30°C)		1710.3409	1779.6712	-7.21	-0.00413
Extreme (-40°C)		1710.3408	1779.6711	-8.13	-0.00466
25°C	LV	1710.3413	1779.6716	3.89	0.00223
	HV	1710.3407	1779.6713	6.47	0.00371
(16QAM, 20MHz BANDWIDTH)					
Condition		1710	1780	Delta(Hz)	Frequency Stability(ppm)
Temperature	Voltage	F low@-13dBm(MHz)	F high@-13dBm(MHz)		
Normal (25°C)	Normal	1710.4049	1779.7132	-1.97	-0.00113
Extreme (85°C)		1710.4051	1779.7131	-2.98	-0.00171
Extreme (80°C)		1710.4069	1779.7131	-6.40	-0.00367
Extreme (70°C)		1710.4047	1779.7144	-4.42	-0.00253
Extreme (60°C)		1710.4042	1779.7145	0.08	0.00005
Extreme (50°C)		1710.4046	1779.7135	-0.67	-0.00038
Extreme (40°C)		1710.4061	1779.7123	-8.29	-0.00475
Extreme (30°C)		1710.4042	1779.7139	-1.03	-0.00059
Extreme (20°C)		1710.4039	1779.7142	0.28	0.00016
Extreme (10C)		1710.4054	1779.7127	-4.34	-0.00249
Extreme (0°C)		1710.4043	1779.7138	-2.64	-0.00151
Extreme (-10°C)		1710.4043	1779.7141	-2.85	-0.00163
Extreme (-20°C)		1710.4056	1779.7125	-6.34	-0.00363
Extreme (-30°C)		1710.4046	1779.7135	-2.06	-0.00118
Extreme (-40°C)		1710.4047	1779.7134	-5.29	-0.00303





25°C	LV	1710.4042	1779.7139	-3.54	-0.00203
	HV	1710.4048	1779.7133	-7.00	-0.00401

LTE Band 71					
(QPSK, 20MHz BANDWIDTH)					
Condition		663	698	Delta(Hz)	Frequency Stability(ppm)
Temperature	Voltage	F low@-13dBm(MHz)	F high@-13dBm(MHz)		
Normal (25°C)	Normal	663.5332	697.4977	4.02	0.00230
Extreme (85°C)		663.6528	697.6175	6.14	0.00352
Extreme (80°C)		663.5318	697.4965	-2.23	-0.00128
Extreme (70°C)		663.5432	697.5079	-1.56	-0.00089
Extreme (60°C)		663.5391	697.5038	6.49	0.00372
Extreme (50°C)		663.5361	697.5008	-5.08	-0.00291
Extreme (40°C)		663.5318	697.4965	-1.82	-0.00104
Extreme (30°C)		663.5432	697.5079	-0.55	-0.00032
Extreme (20°C)		663.5391	697.5038	7.17	0.00411
Extreme (10C)		663.5321	697.4968	-9.32	-0.00534
Extreme (0°C)		663.5375	697.5022	7.40	0.00424
Extreme (-10°C)		663.5387	697.5034	4.78	0.00274
Extreme (-20°C)		663.5345	697.4992	-8.13	-0.00466
Extreme (-30°C)		663.5361	697.5008	-6.09	-0.00349
Extreme (-40°C)		663.5311	697.4958	-7.05	-0.00404
25°C		LV	663.5326	697.4973	6.36
	HV	663.5361	697.5008	7.38	0.00423
(16QAM, 20MHz BANDWIDTH)					
Condition		663	698	Delta(Hz)	Frequency Stability(ppm)
Temperature	Voltage	F low@-13dBm(MHz)	F high@-13dBm(MHz)		
Normal (25°C)	Normal	663.5258	697.4905	0.97	0.00056
Extreme (85°C)		663.4064	697.3707	3.93	0.00225
Extreme (80°C)		663.5282	697.4926	1.26	0.00072
Extreme (70°C)		663.5161	697.4808	3.21	0.00184
Extreme (60°C)		663.5199	697.4846	4.58	0.00262
Extreme (50°C)		663.5227	697.4874	2.22	0.00127
Extreme (40°C)		663.5273	697.4917	1.50	0.00086
Extreme (30°C)		663.5156	697.4803	0.31	0.00018
Extreme (20°C)		663.5197	697.4844	3.52	0.00202
Extreme (10C)		663.5267	697.4914	-1.33	-0.00076
Extreme (0°C)		663.5213	697.4867	1.95	0.00112
Extreme (-10°C)		663.5201	697.4848	1.46	0.00084



Extreme (-20°C)		663.5243	697.4891	0.63	0.00036
Extreme (-30°C)		663.5227	697.4874	2.25	0.00129
Extreme (-40°C)		663.5277	697.4924	2.07	0.00119
25°C	LV	663.5262	697.4909	2.96	0.00170
	HV	663.5227	697.4874	0.84	0.00048

## 5.7 Spurious Emissions at Antenna Terminals

### Ambient condition

Temperature	Relative humidity	Pressure
23°C ~25°C	45%~50%	101.5kPa

### Method of Measurement

The EUT was connected to Spectrum Analyzer and Base Station Simulator via power Splitter. The measurement is carried out using a spectrum analyzer. The spectrum analyzer scans from 9kHz to the 10th harmonic of the carrier. The peak detector is used.

RBW is set to 100kHz, VBW is set to 300kHz for 30MHz~1GHz

RBW is set to 1MHz, VBW is set to 3MHz for above 1GHz, Sweep is set to ATUO.

Of those disturbances below (limit – 20 dB), the mark is not required for the EUT.

The modulation mode and RB allocation refer to section 5.1, using the maximum output power configuration.

### Test setup

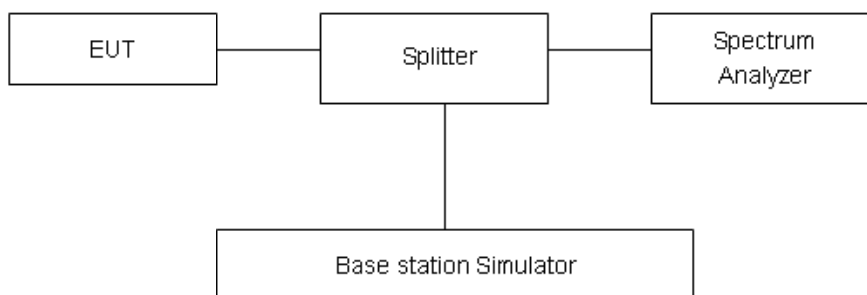

### Limits

LTE -4 Rule Part 27.53(h) specifies that “for operations in the 1695-1710 MHz, 1710-1755 MHz, 1755-1780 MHz, 1915-1920 MHz, 1995-2000 MHz, 2000-2020 MHz, 2110-2155 MHz, 2155-2180 MHz, and 2180-2200 bands, the power of any emission outside a licensee's frequency block shall be attenuated below the transmitter power (P) in watts by at least 43 + 10 log<sub>10</sub> (P) dB..”

LTE -12 Rule Part 27.53 (g) For operations in the 600 MHz band and the 698-746 MHz band, the power of any emission outside a licensee's frequency band(s) of operation shall be attenuated below the transmitter power (P) within the licensed band(s) of operation, measured in watts, by at least 43 + 10 log (P) dB. Compliance with this provision is based on the use of measurement instrumentation employing a resolution bandwidth of 100 kilohertz or greater. However, in the 100 kilohertz bands immediately outside and adjacent to a licensee's frequency block, a resolution bandwidth of at least 30 kHz may be employed.

LTE -13 Rule Part 27.53(f) For operations in the 746-758 MHz, 775-788 MHz, and 805-806 MHz bands, emissions in the band 1559-1610 MHz shall be limited to –70 dBW/MHz equivalent



isotropically radiated power (EIRP) for wideband signals, and  $-80$  dBW EIRP for discrete emissions of less than 700 Hz bandwidth. For the purpose of equipment authorization, a transmitter shall be tested with an antenna that is representative of the type that will be used with the equipment in normal operation.

LTE 13- Part 27.53 (c) For operations in the 746-758 MHz band and the 776-788 MHz band, the power of any emission outside the licensee's frequency band(s) of operation shall be attenuated below the transmitter power (P) within the licensed band(s) of operation, measured in watts, in accordance with the following:

- (1) On any frequency outside the 746-758 MHz band, the power of any emission shall be attenuated outside the band below the transmitter power (P) by at least  $43 + 10 \log (P)$  dB;
- (2) On any frequency outside the 776-788 MHz band, the power of any emission shall be attenuated outside the band below the transmitter power (P) by at least  $43 + 10 \log (P)$  dB;
- (3) On all frequencies between 763-775 MHz and 793-805 MHz, by a factor not less than  $76 + 10 \log (P)$  dB in a 6.25 kHz band segment, for base and fixed stations;
- (4) On all frequencies between 763-775 MHz and 793-805 MHz, by a factor not less than  $65 + 10 \log (P)$  dB in a 6.25 kHz band segment, for mobile and portable stations;
- (5) Compliance with the provisions of paragraphs (c)(1) and (c)(2) of this section is based on the use of measurement instrumentation employing a resolution bandwidth of 100 kHz or greater. However, in the 100 kHz bands immediately outside and adjacent to the frequency block, a resolution bandwidth of at least 30 kHz may be employed;

Part 27.53(a)/(h)/(g) Limit		-13 dBm
Part 27.53(f) Limit	Limit out of the band 1559-1610 MHz	-13 dBm
	Limit in the band 1559-1610 MHz	-40 dBm

### Measurement Uncertainty

The assessed measurement uncertainty to ensure 99.75% confidence level for the normal distribution is with the coverage factor  $k = 1.96$ .

Frequency	Uncertainty
9kHz-1GHz	0.684 dB
1GHz-27GHz	1.407 dB

**Test Result**

Sweep the whole frequency band through the range from 9kHz to the 10th harmonic of the carrier, the emissions more than 20 dB below the limit are not reported.

The signal beyond the limit is carrier.

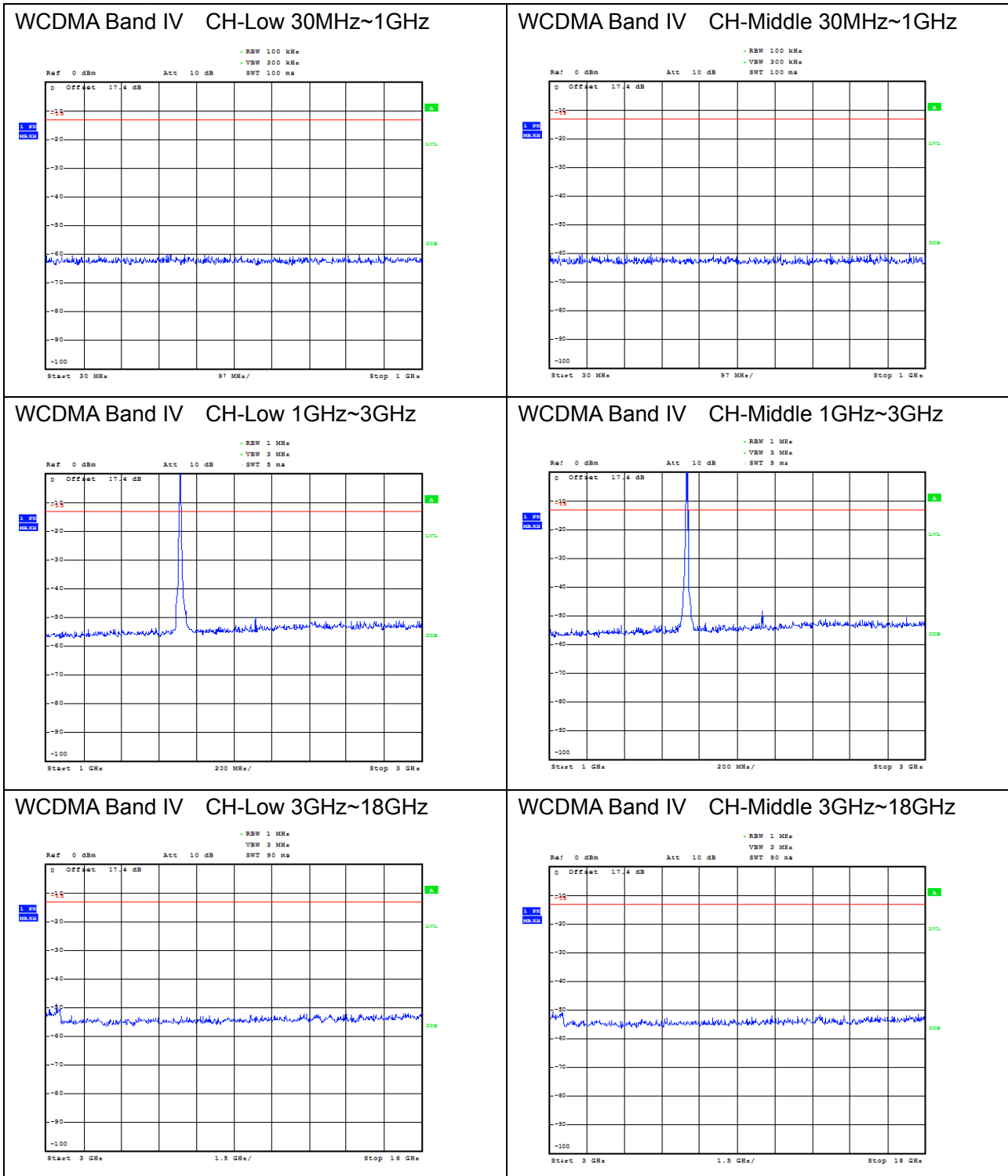



### WCDMA Band IV CH-High 30MHz~1GHz

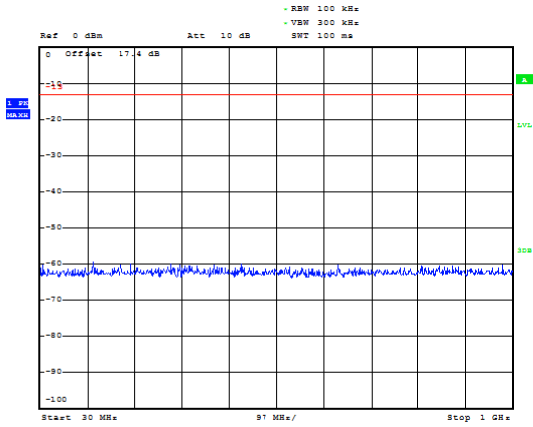

### WCDMA Band IV CH-High 1GHz~3GHz

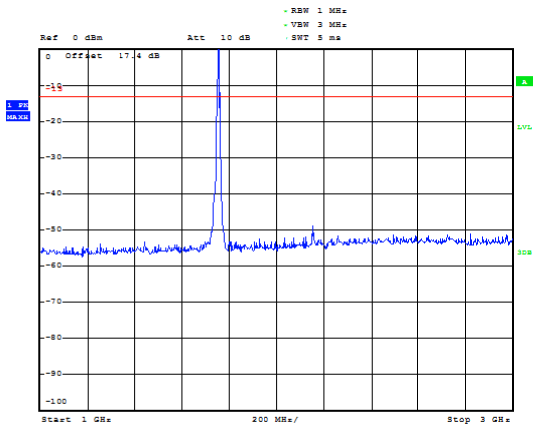

### WCDMA Band IV CH-High 3GHz~18GHz

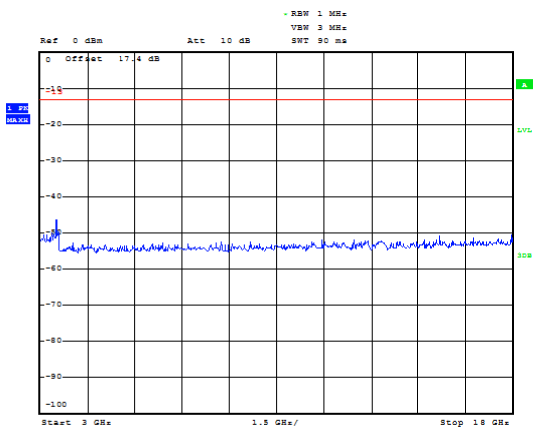



LTE Band 4 1.4MHz CH-Low 30MHz~1GHz

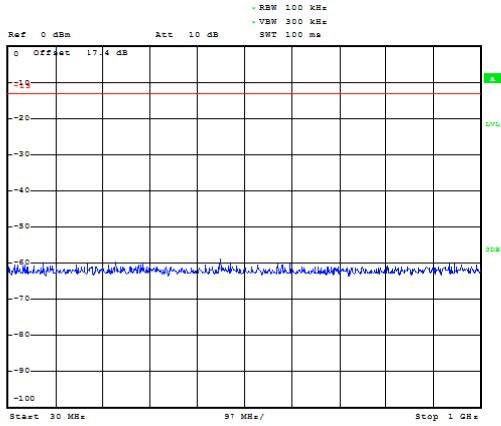

LTE Band 4 1.4MHz CH-Middle 30MHz~1GHz

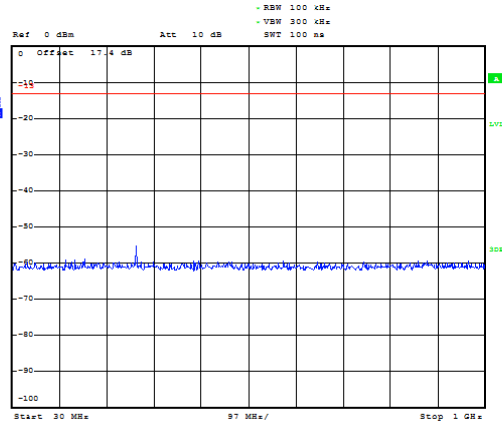

LTE Band 4 1.4MHz CH-Low 1GHz~3GHz

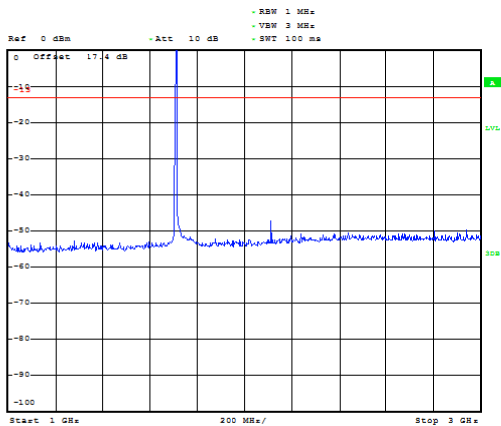

LTE Band 4 1.4MHz CH-Middle 1GHz~3GHz

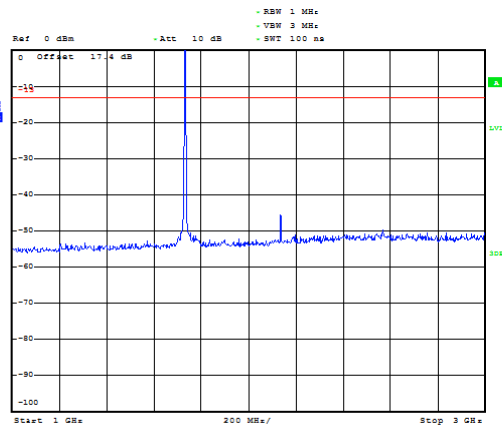

LTE Band 4 1.4MHz CH-Low 3GHz~18GHz

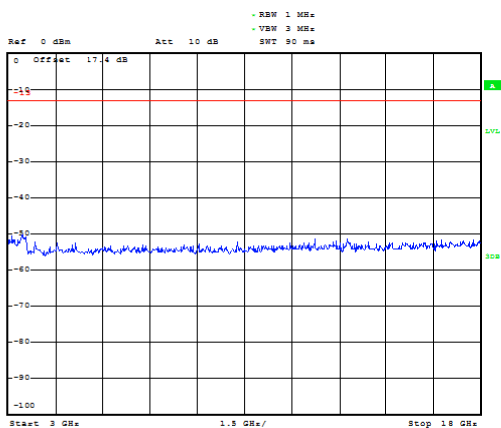

LTE Band 4 1.4MHz CH-Middle 3GHz~18GHz

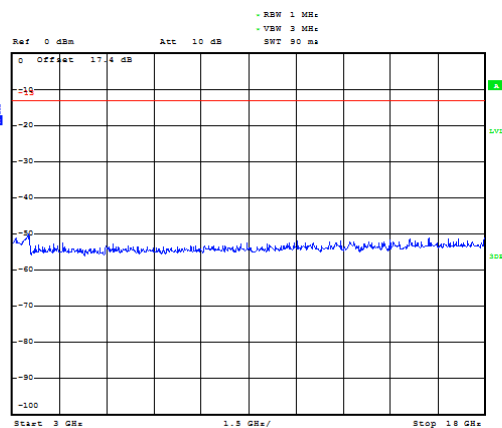



### LTE Band 4 1.4MHz CH-High 30MHz~1GHz

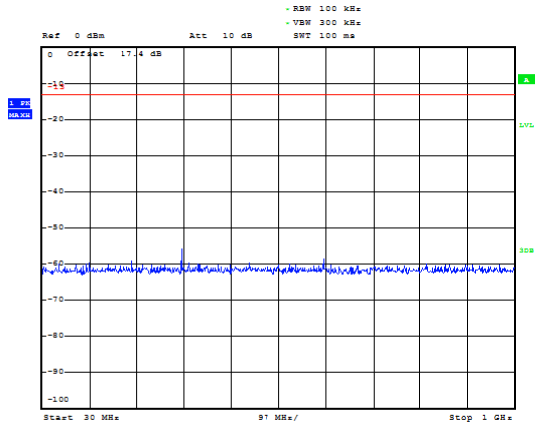

### LTE Band 4 3MHz CH-Low 30MHz~1GHz

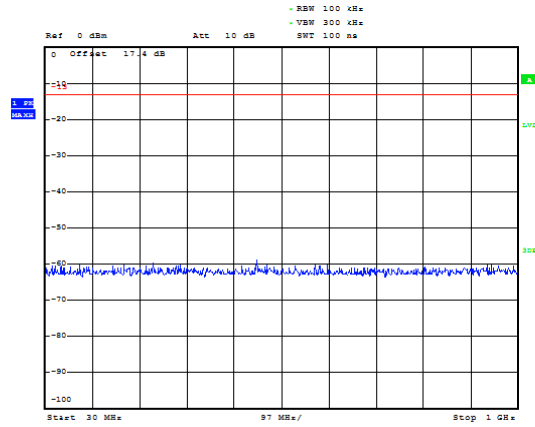

### LTE Band 4 1.4MHz CH-High 1GHz~3GHz

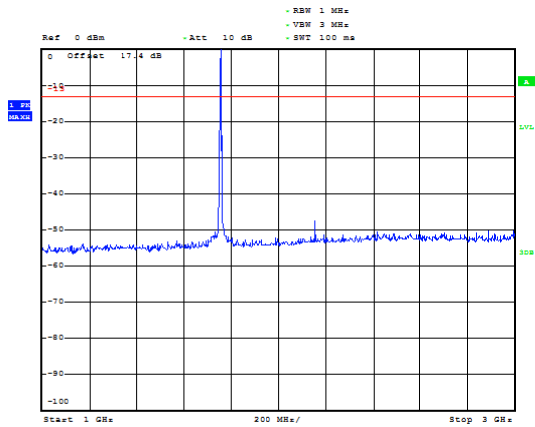

### LTE Band 4 3MHz CH-Low 1GHz~3GHz

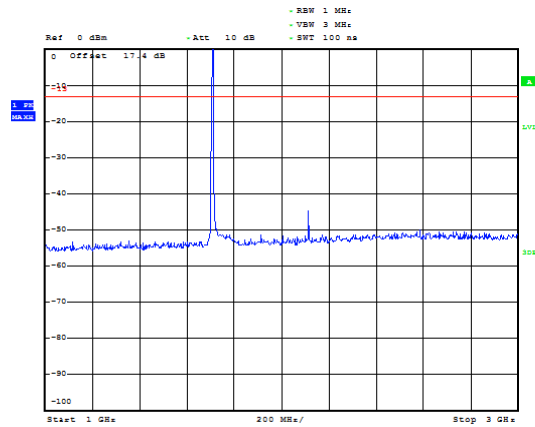

### LTE Band 4 1.4MHz CH-High 3GHz~18GHz

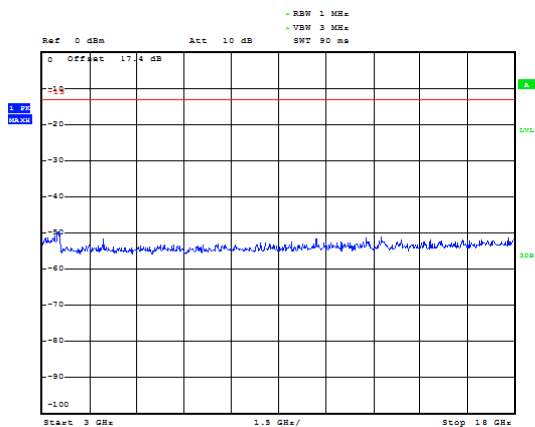

### LTE Band 4 3MHz CH-Low 3GHz~18GHz

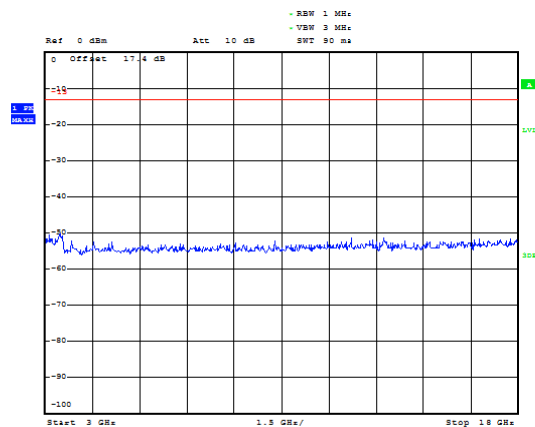





### LTE Band 4 3MHz CH-Middle 30MHz~1GHz

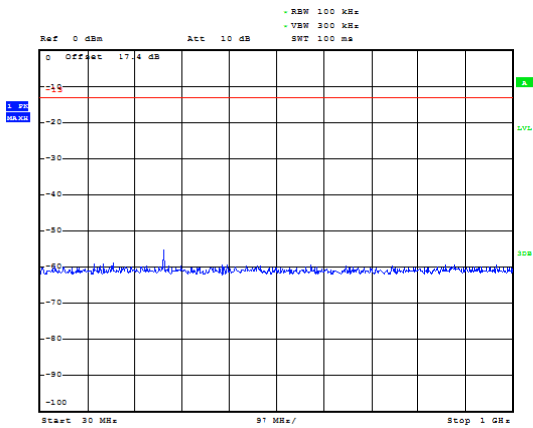

### LTE Band 4 3MHz CH-High 30MHz~1GHz

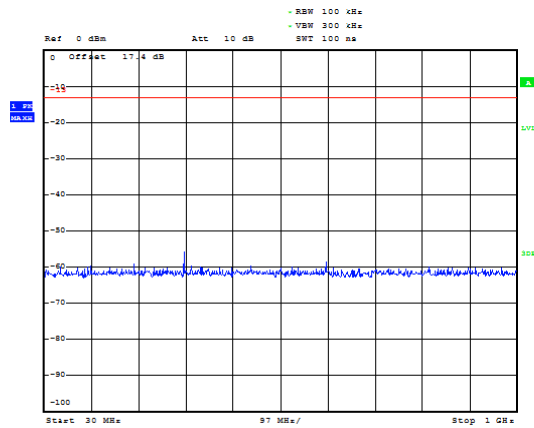

### LTE Band 4 3MHz CH-Middle 1GHz~3GHz

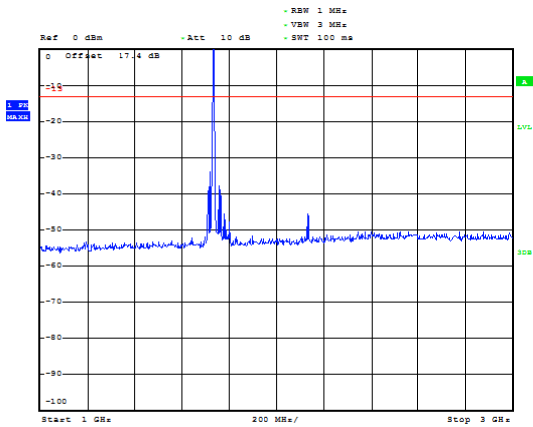

### LTE Band 4 3MHz CH-High 1GHz~3GHz

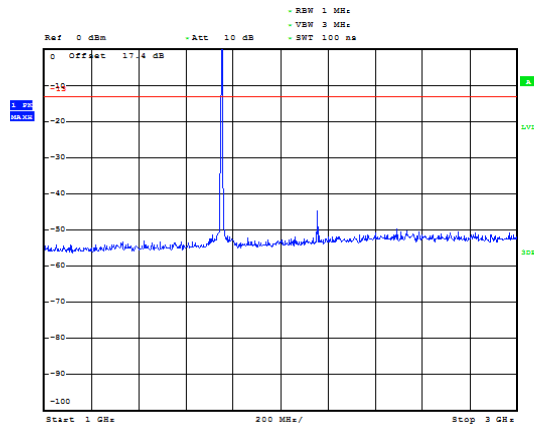

### LTE Band 4 3MHz CH-Middle 3GHz~18GHz

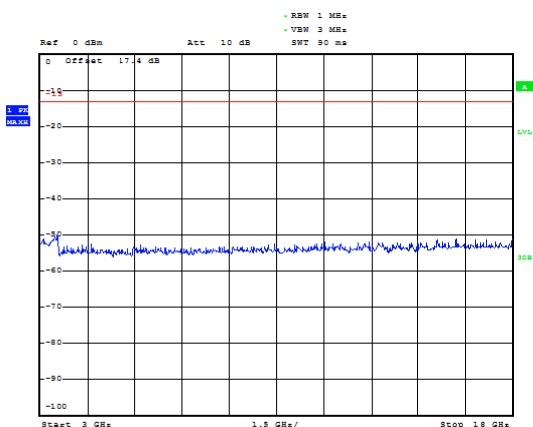

### LTE Band 4 3MHz CH-High 3GHz~18GHz

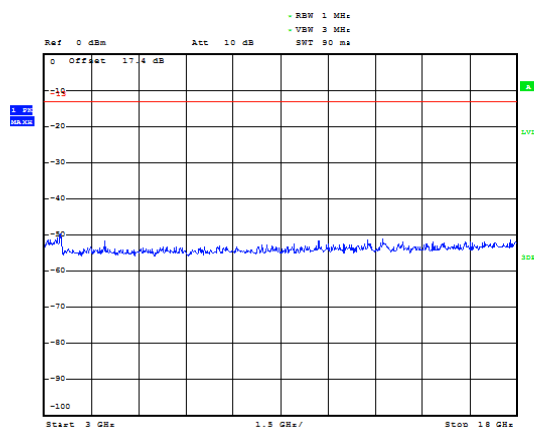



### LTE Band 4 5MHz CH-Low 30MHz~1GHz

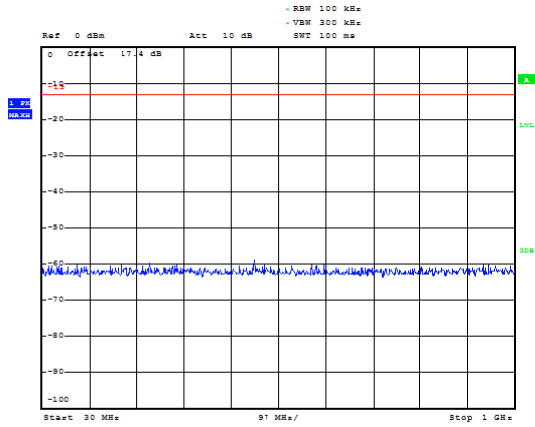

### LTE Band 4 5MHz CH-Middle 30MHz~1GHz

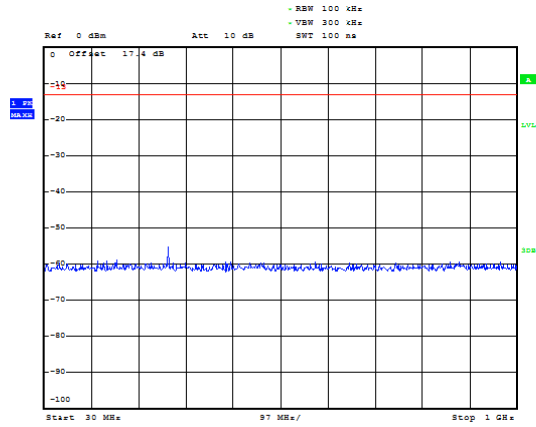

### LTE Band 4 5MHz CH-Low 1GHz~3GHz

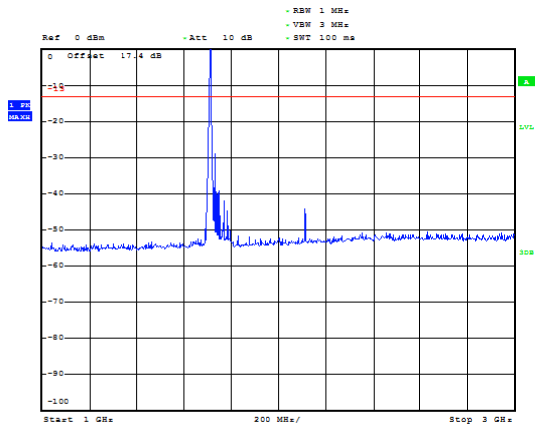

### LTE Band 4 5MHz CH-Middle 1GHz~3GHz

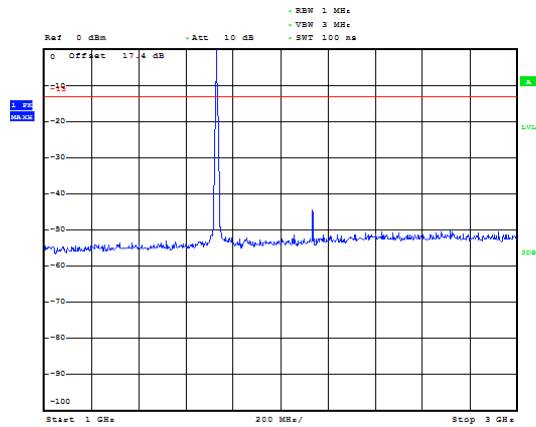

### LTE Band 4 5MHz CH-Low 3GHz~18GHz

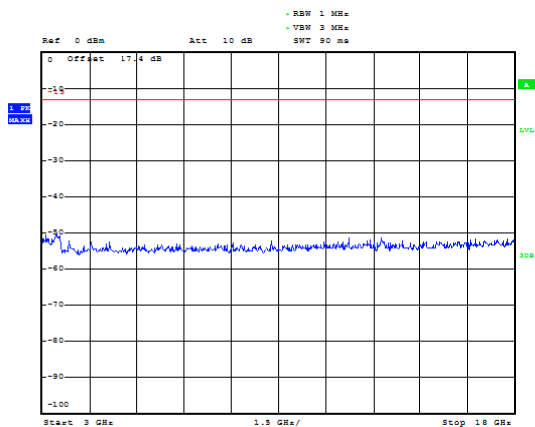

### LTE Band 4 5MHz CH-Middle 3GHz~18GHz

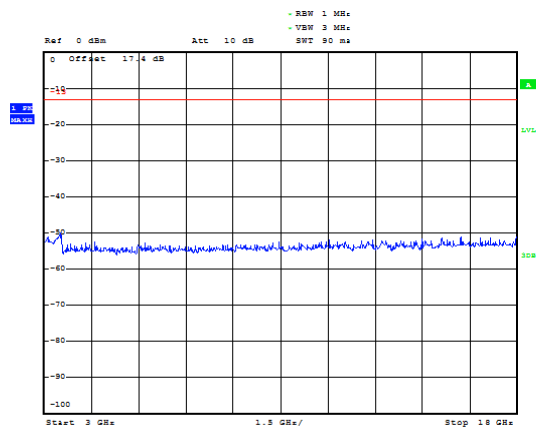



### LTE Band 4 5MHz CH-High 30MHz~1GHz

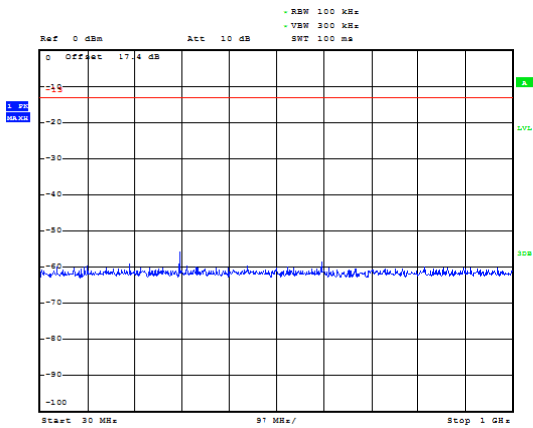

### LTE Band 4 10MHz CH-Low 30MHz~1GHz

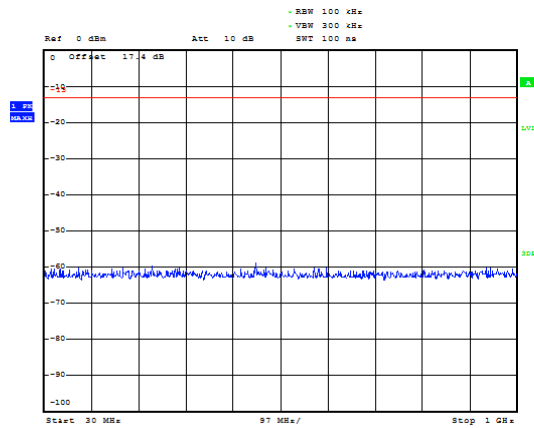

### LTE Band 4 5MHz CH-High 1GHz~3GHz

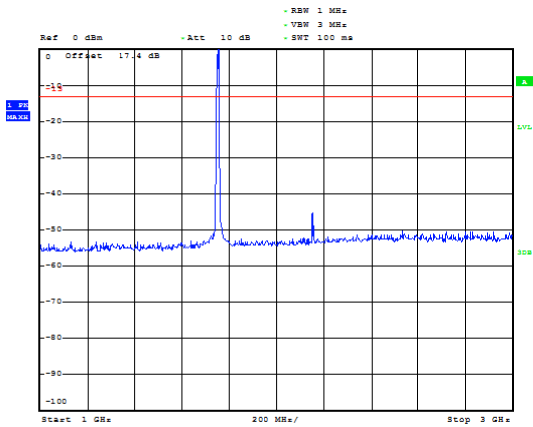

### LTE Band 4 10MHz CH-Low 1GHz~3GHz

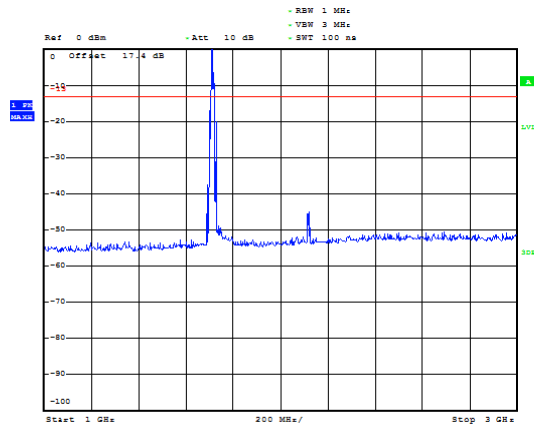

### LTE Band 4 5MHz CH-High 3GHz~18GHz

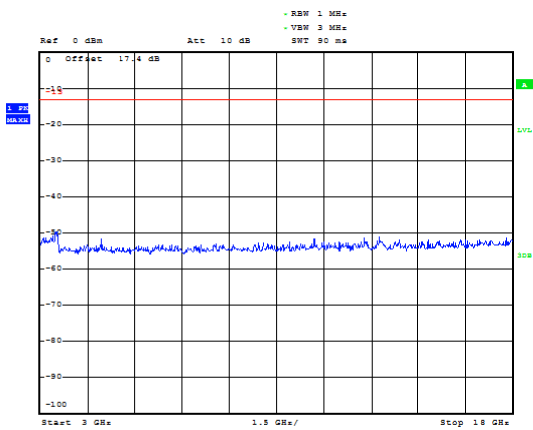

### LTE Band 4 10MHz CH-Low 3GHz~18GHz

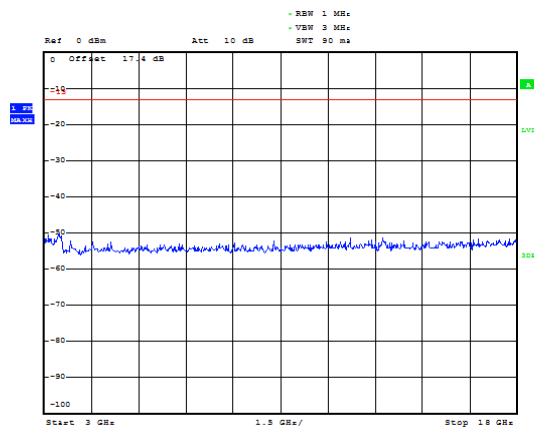



### LTE Band 4 10MHz CH-Middle 30MHz~1GHz

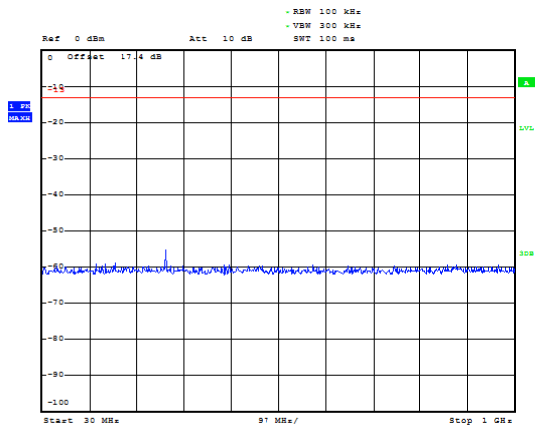

### LTE Band 4 10MHz CH-High 30MHz~1GHz

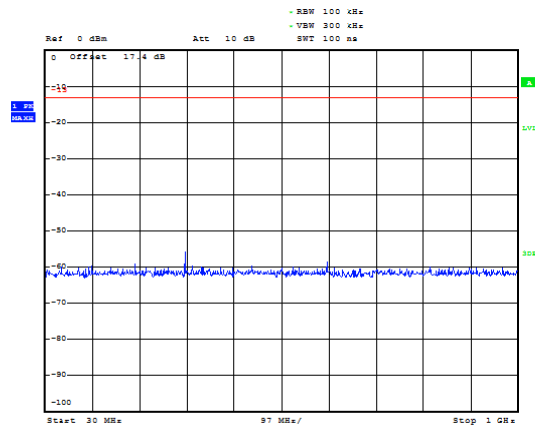

### LTE Band 4 10MHz CH-Middle 1GHz~3GHz

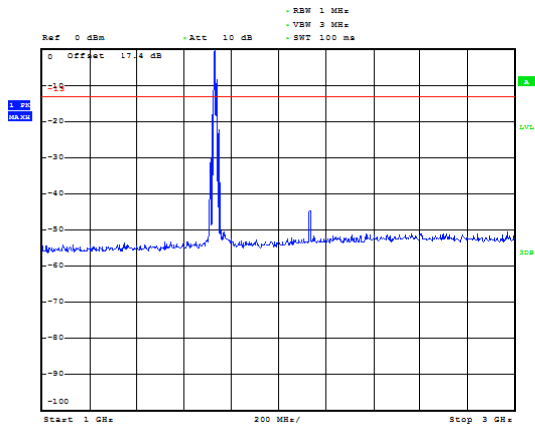

### LTE Band 4 10MHz CH-High 1GHz~3GHz

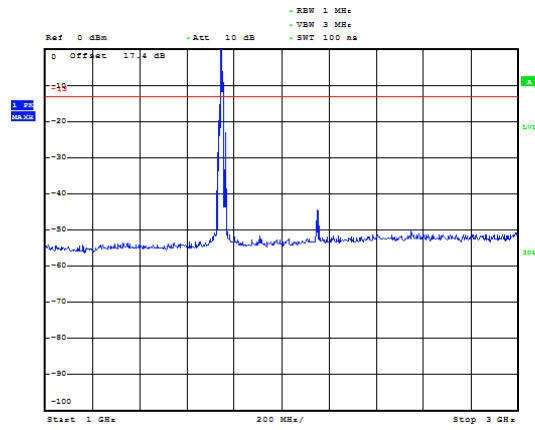

### LTE Band 4 10MHz CH-Middle 3GHz~18GHz

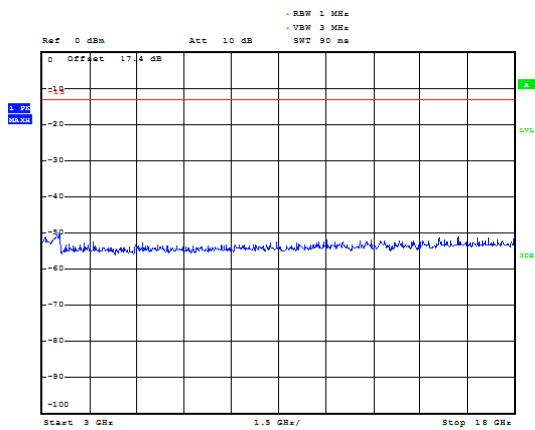

### LTE Band 4 10MHz CH-High 3GHz~18GHz

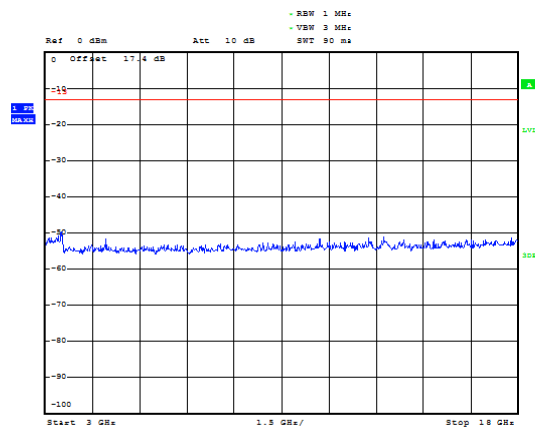



LTE Band 4 15MHz CH-Low 30MHz~1GHz

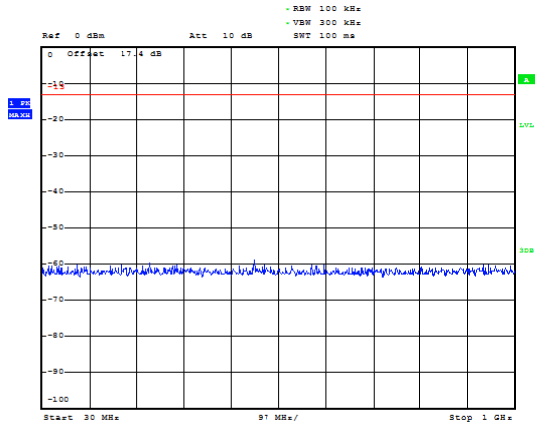

LTE Band 4 15MHz CH-Middle 30MHz~1GHz

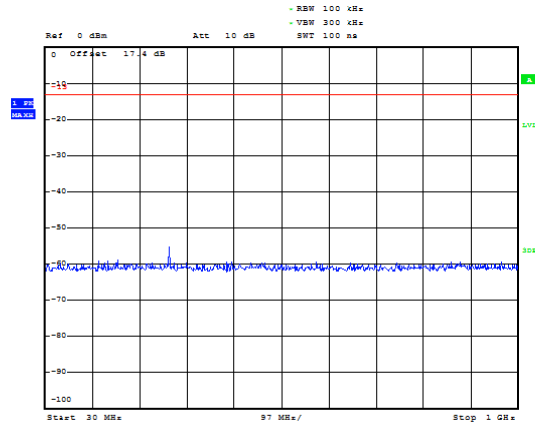

LTE Band 4 15MHz CH-Low 1GHz~3GHz

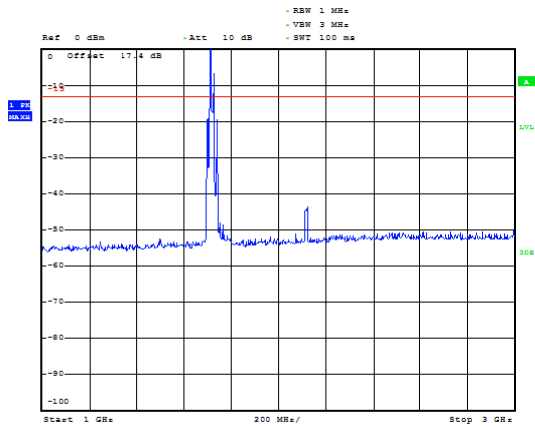

LTE Band 4 15MHz CH-Middle 1GHz~3GHz

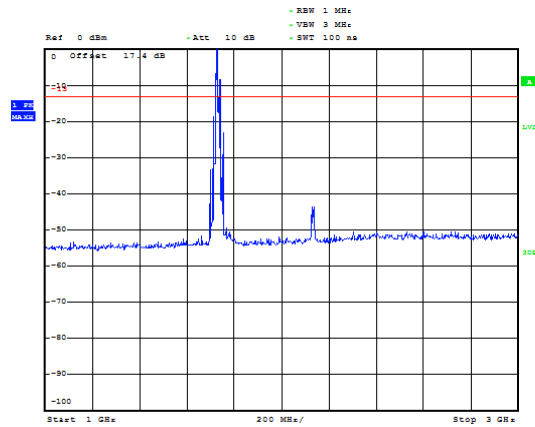

LTE Band 4 15MHz CH-Low 3GHz~18GHz

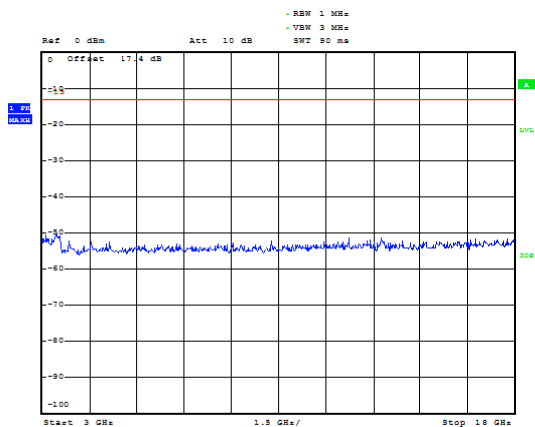

LTE Band 4 15MHz CH-Middle 3GHz~18GHz

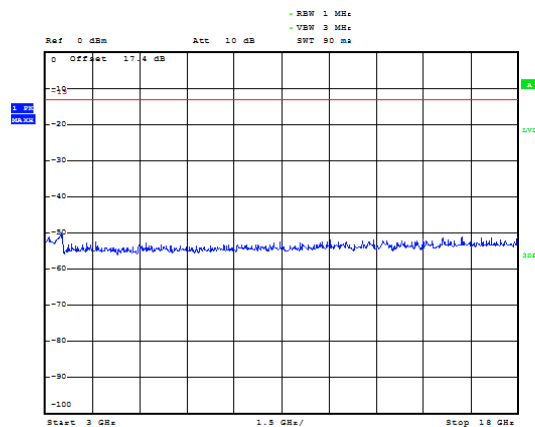



### LTE Band 4 15MHz CH-High 30MHz~1GHz

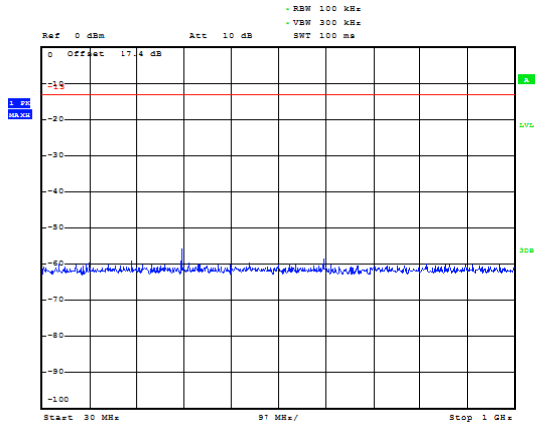

### LTE Band 4 20MHz CH-Low 30MHz~1GHz

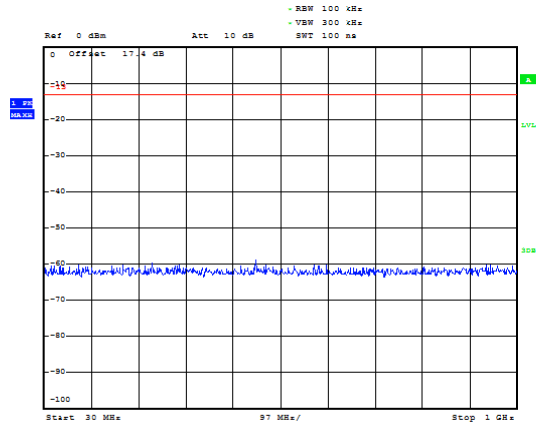

### LTE Band 4 15MHz CH-High 1GHz~3GHz

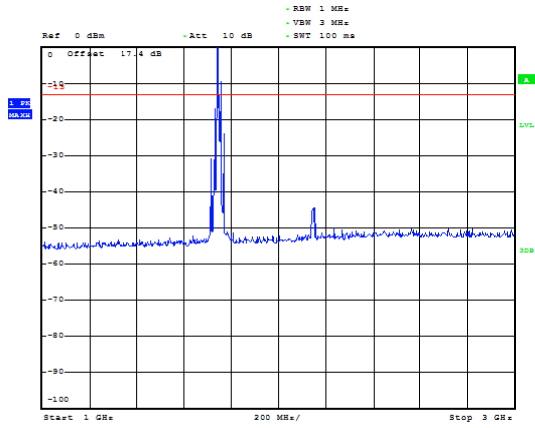

### LTE Band 4 20MHz CH-Low 1GHz~3GHz

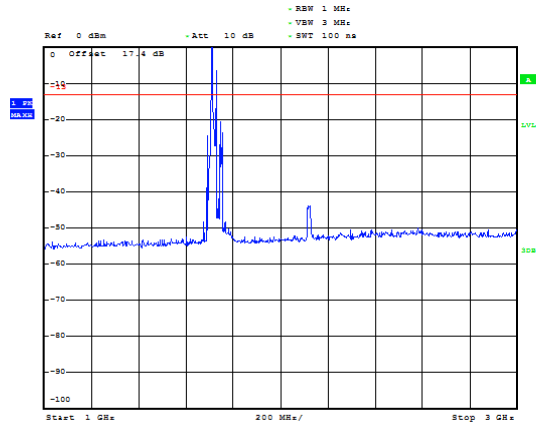

### LTE Band 4 15MHz CH-High 3GHz~18GHz

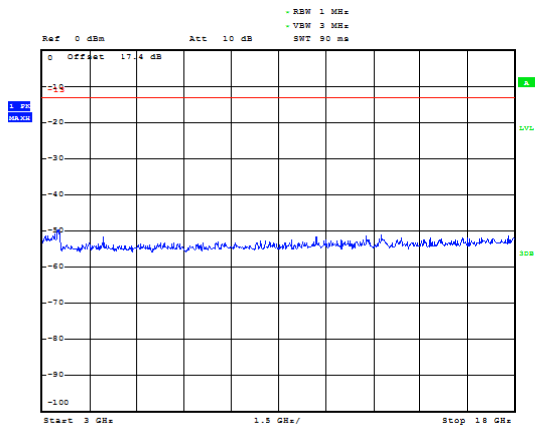

### LTE Band 4 20MHz CH-Low 3GHz~18GHz

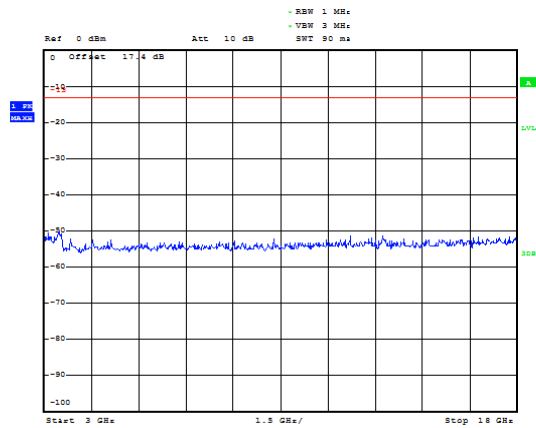



### LTE Band 4 20MHz CH-Middle 30MHz~1GHz

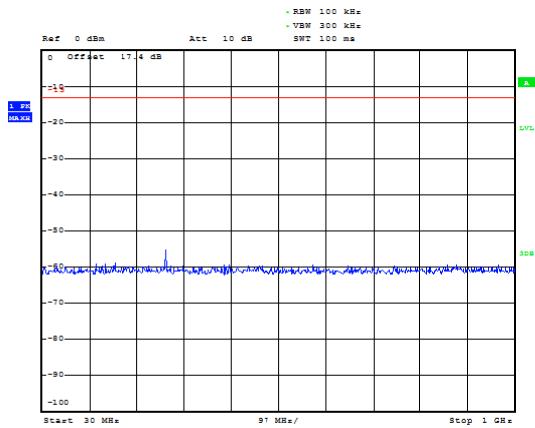

### LTE Band 4 20MHz CH-High 30MHz~1GHz

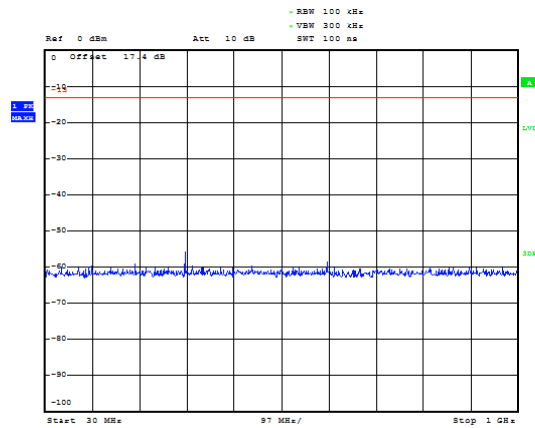

### LTE Band 4 20MHz CH-Middle 1GHz~3GHz

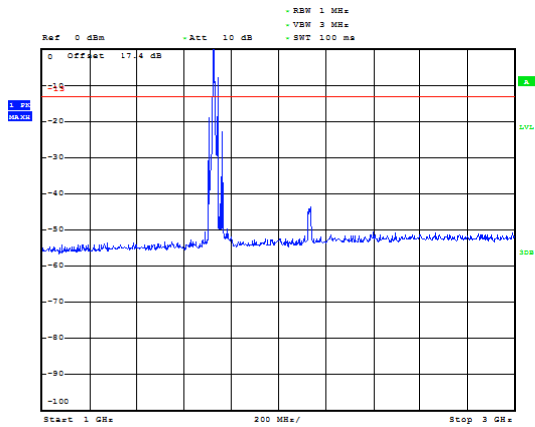

### LTE Band 4 20MHz CH-High 1GHz~3GHz

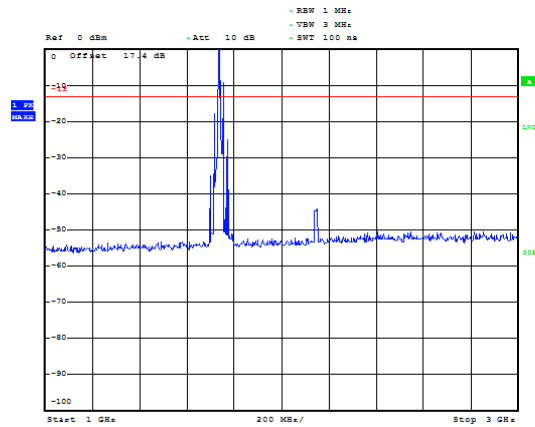

### LTE Band 4 20MHz CH-Middle 3GHz~18GHz

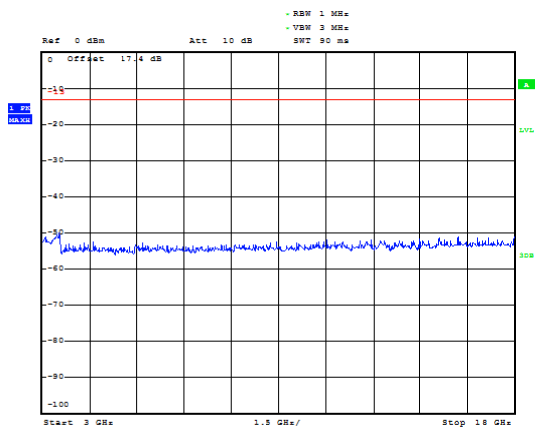

### LTE Band 4 20MHz CH-High 3GHz~18GHz

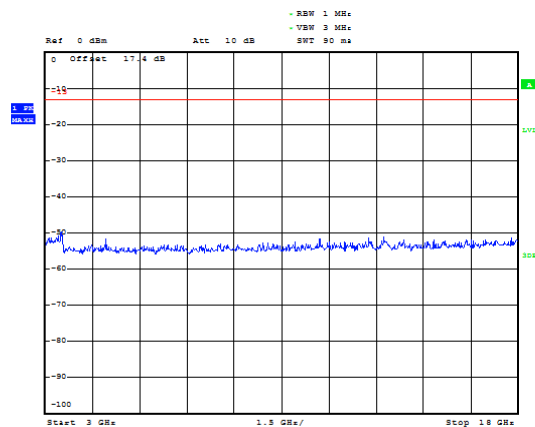



LTE Band 12 1.4MHz CH-Low 30MHz~1GHz

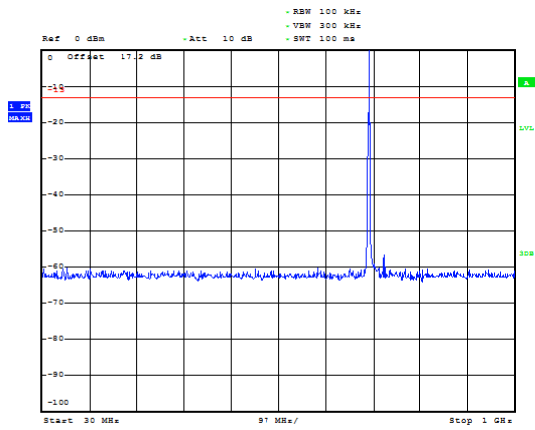

LTE Band 12 1.4MHz CH-Low 1GHz~9GHz

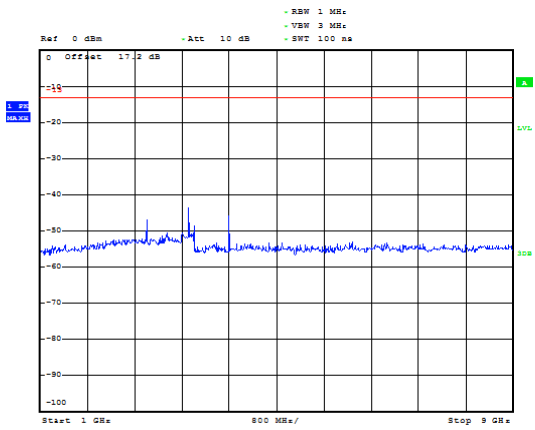

LTE Band 12 1.4MHz CH- Middle 30MHz~1GHz

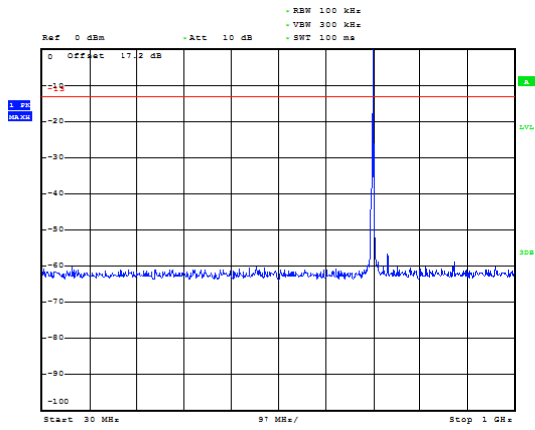

LTE Band 12 1.4MHz CH- Middle 1GHz~9GHz

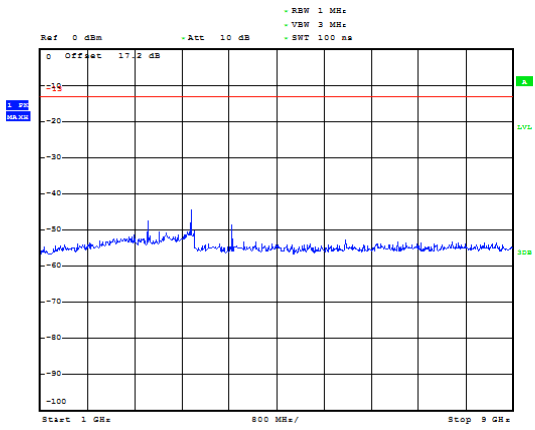

LTE Band 12 1.4MHz CH-High 30MHz~1GHz

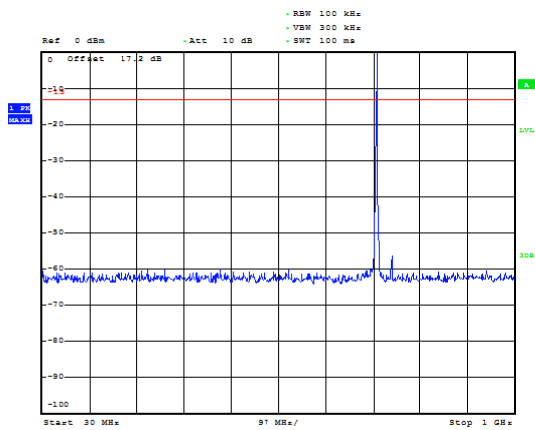

LTE Band 12 1.4MHz CH-High 1GHz~9GHz

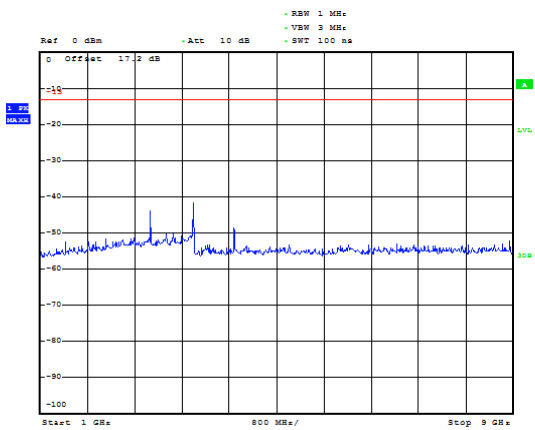





### LTE Band 12 3MHz CH-Low 30MHz~1GHz

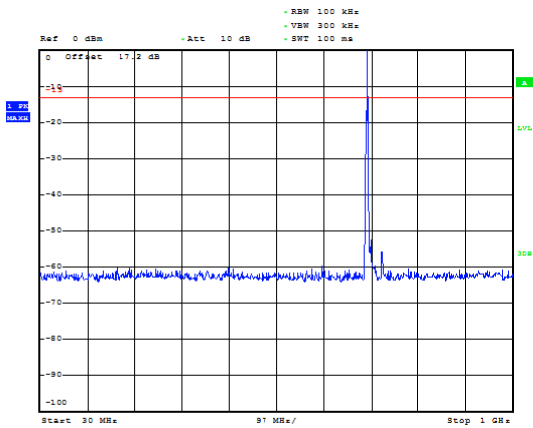

### LTE Band 12 3MHz CH-Low 1GHz~9GHz

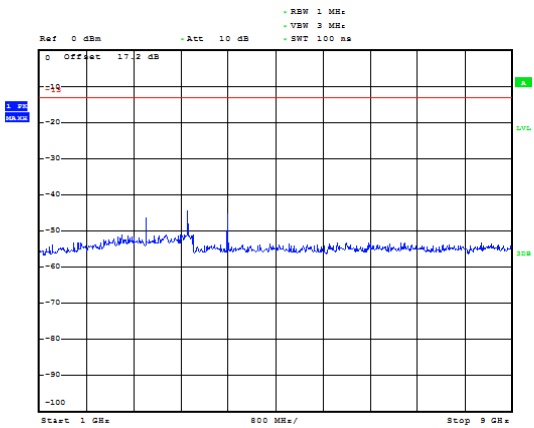

### LTE Band 12 3MHz CH- Middle 30MHz~1GHz

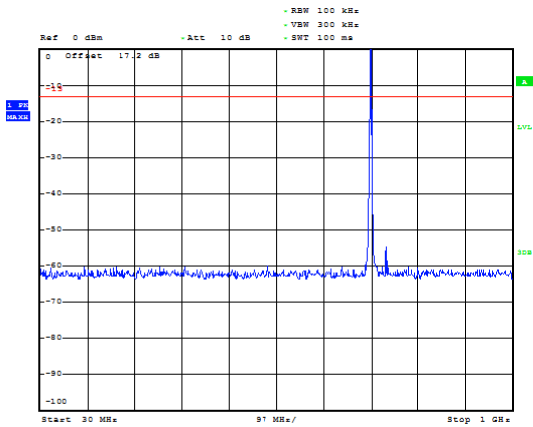

### LTE Band 12 3MHz CH- Middle 1GHz~9GHz

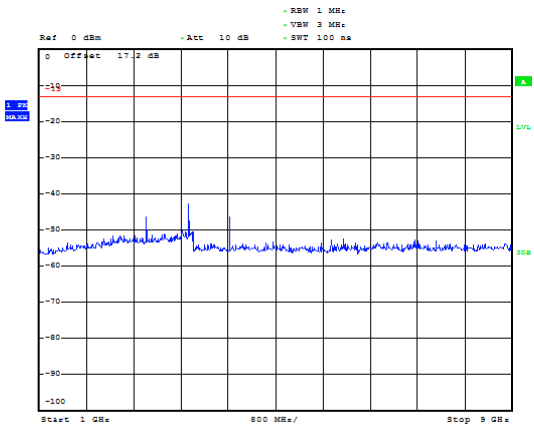

### LTE Band 12 3MHz CH-High 30MHz~1GHz

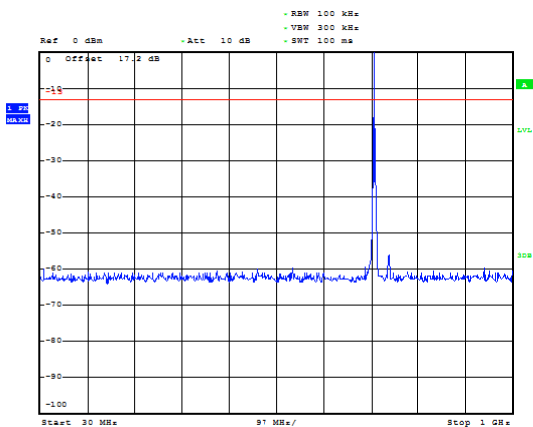

### LTE Band 12 3MHz CH-High 1GHz~9GHz

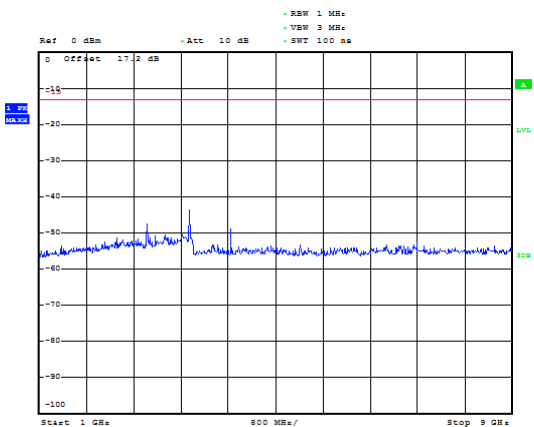



### LTE Band 12 5MHz CH-Low 30MHz~1GHz

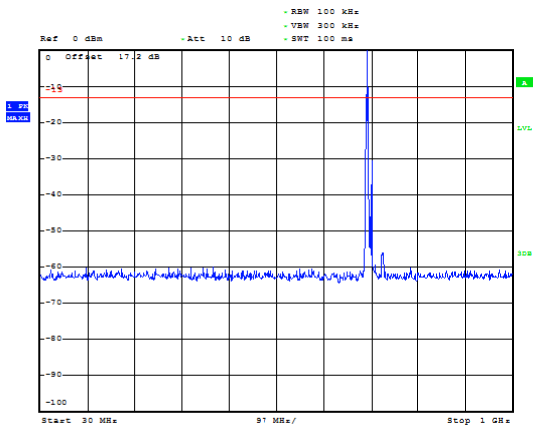

### LTE Band 12 5MHz CH-Low 1GHz~9GHz

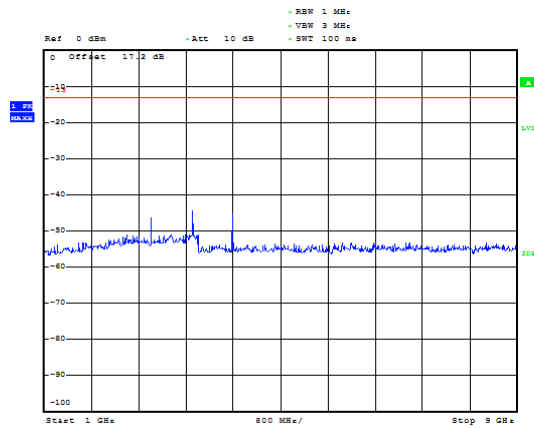

### LTE Band 12 5MHz CH- Middle 30MHz~1GHz

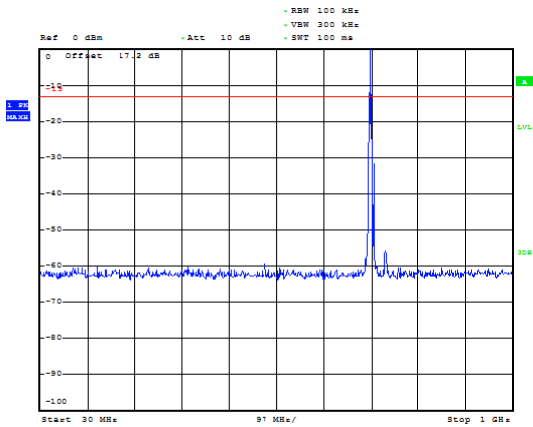

### LTE Band 12 5MHz CH- Middle 1GHz~9GHz

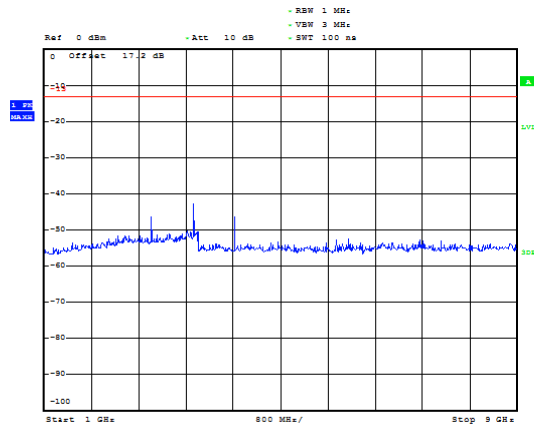

### LTE Band 12 5MHz CH-High 30MHz~1GHz

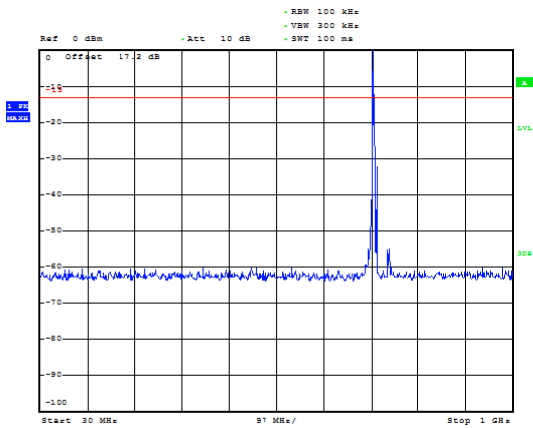

### LTE Band 12 5MHz CH-High 1GHz~9GHz

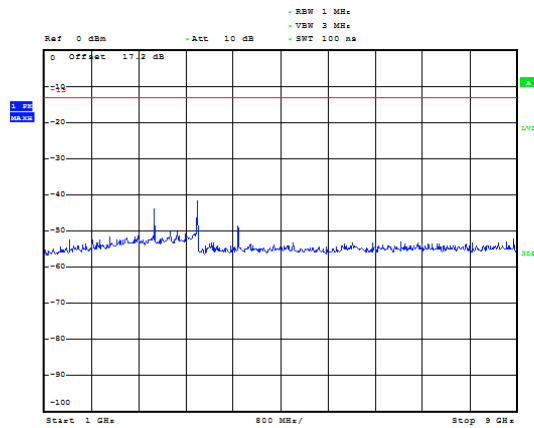



### LTE Band 12 10MHz CH-Low 30MHz~1GHz

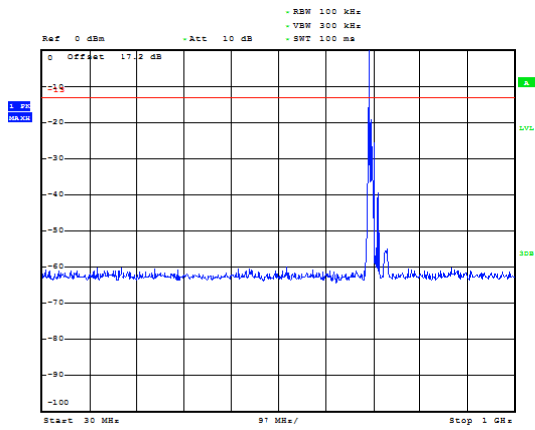

### LTE Band 12 10MHz CH-Low 1GHz~9GHz

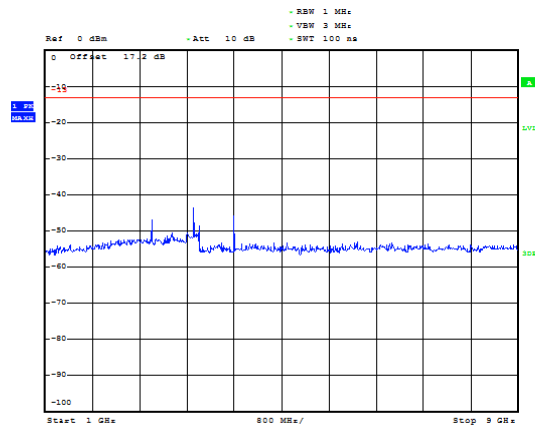

### LTE Band 12 10MHz CH- Middle 30MHz~1GHz

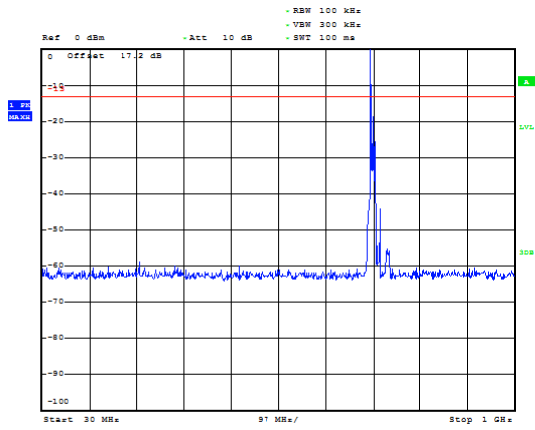

### LTE Band 12 10MHz CH- Middle 1GHz~9GHz

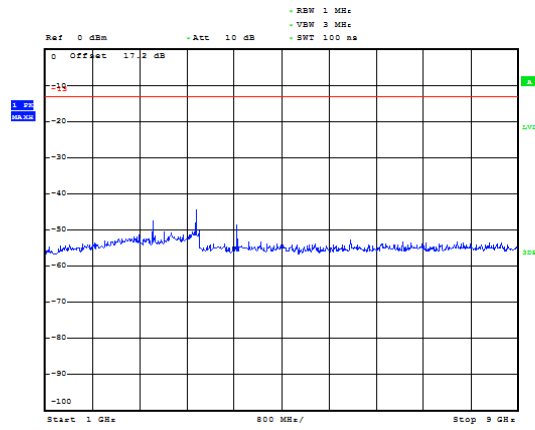

### LTE Band 12 10MHz CH-High 30MHz~1GHz

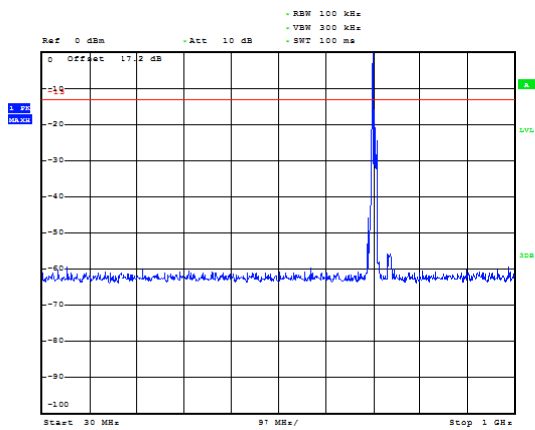

### LTE Band 12 10MHz CH-High 1GHz~9GHz

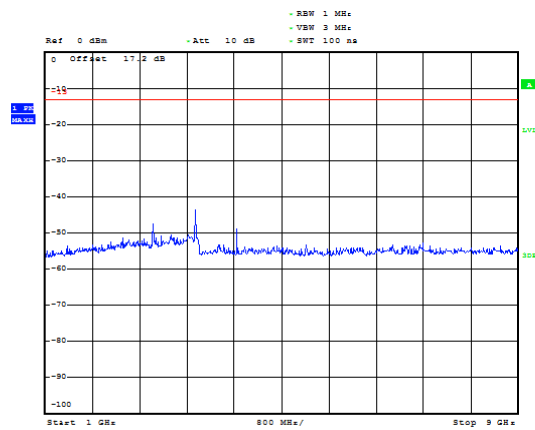



### LTE Band 13 5MHz CH-Low 30MHz~1GHz

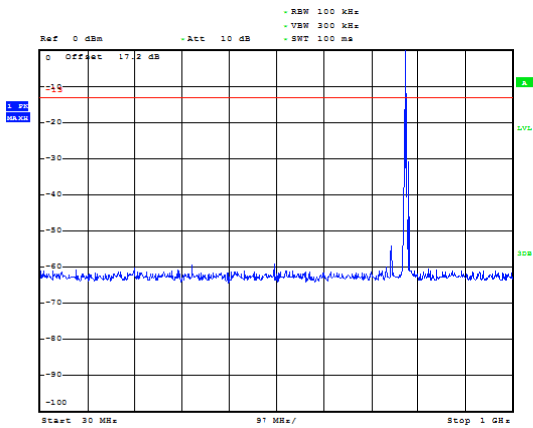

### LTE Band 13 5MHz CH-Low 1GHz~9GHz

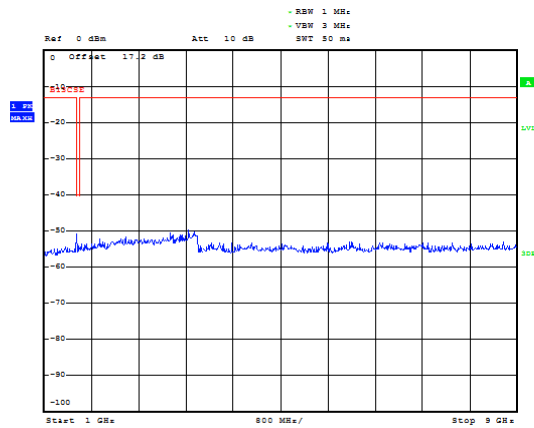

### LTE Band 13 5MHz CH-Middle 30MHz~1GHz

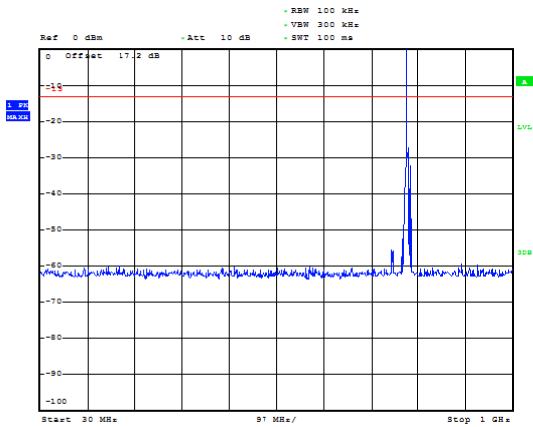

### LTE Band 13 5MHz CH-Middle 1GHz~9GHz

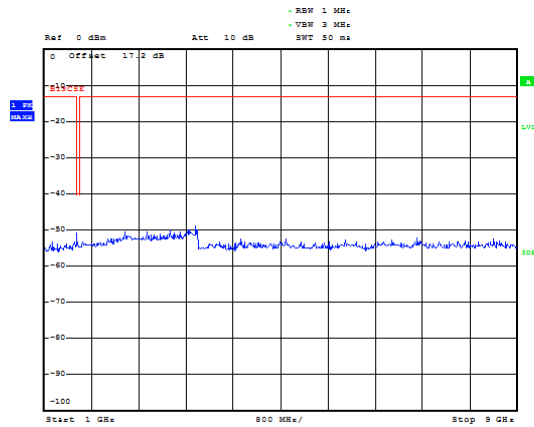

### LTE Band 13 5MHz CH-High 30MHz~1GHz

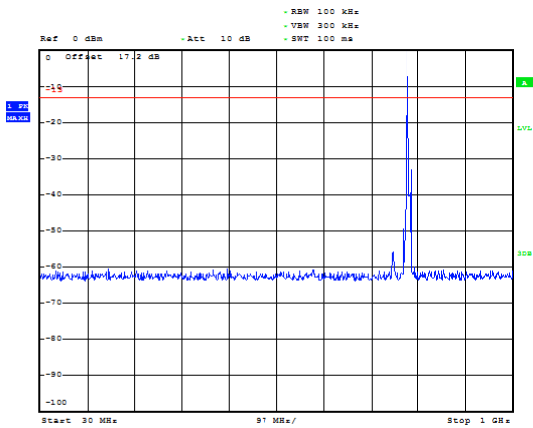

### LTE Band 13 5MHz CH-High 1GHz~9GHz

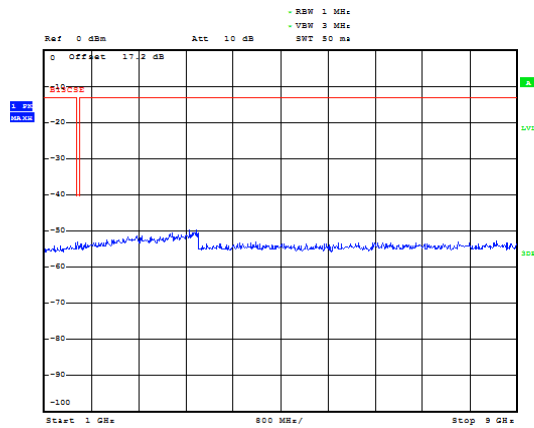



### LTE Band 13 10MHz CH-Middle 30MHz~1GHz

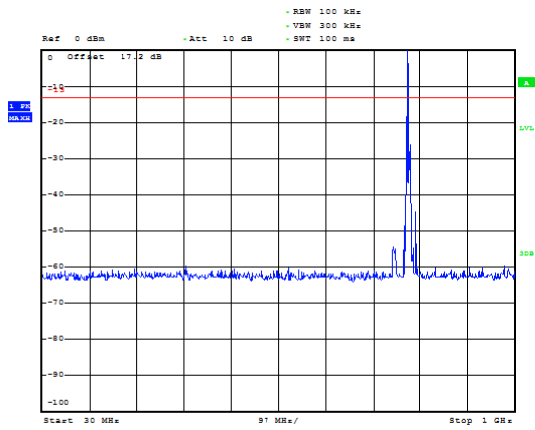

### LTE Band 13 10MHz CH-Middle 1GHz~9GHz

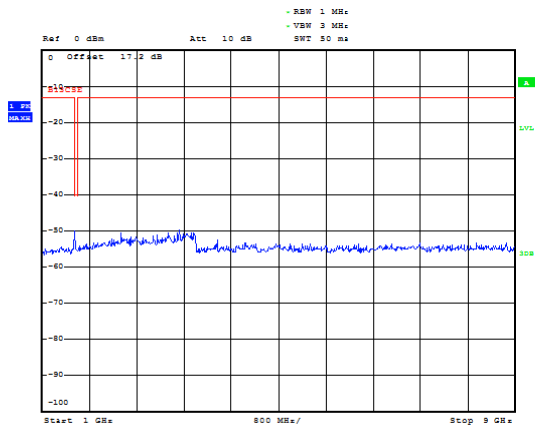



LTE Band 66 1.4MHz CH-Low 30MHz~1GHz

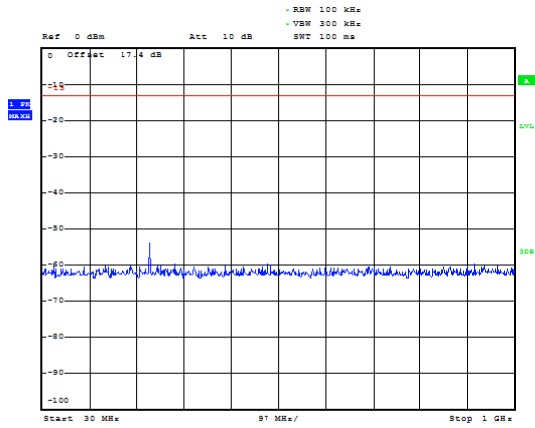

LTE Band 66 1.4MHz CH-Middle 30MHz~1GHz

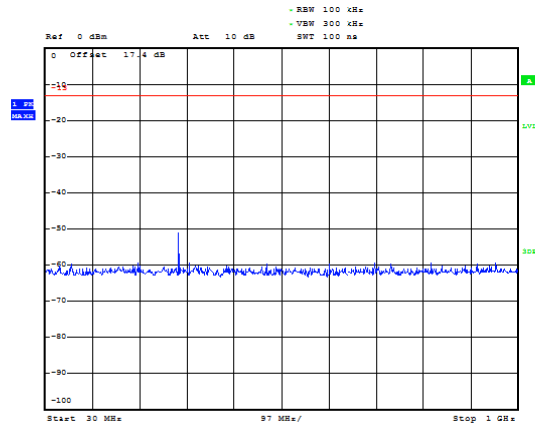

LTE Band 66 1.4MHz CH-Low 1GHz~3GHz

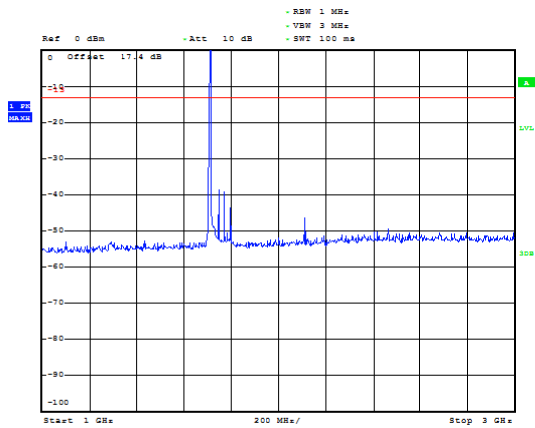

LTE Band 66 1.4MHz CH-Middle 1GHz~3GHz

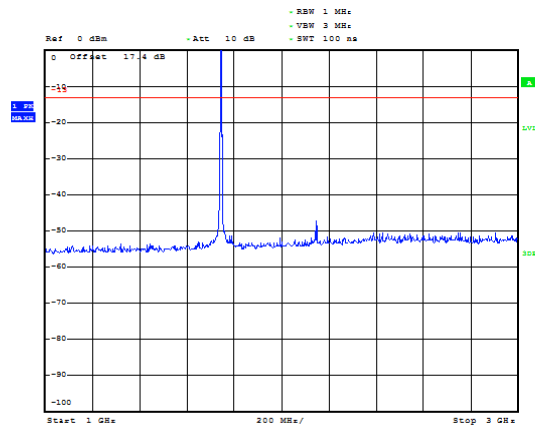

LTE Band 66 1.4MHz CH-Low 3GHz~18GHz

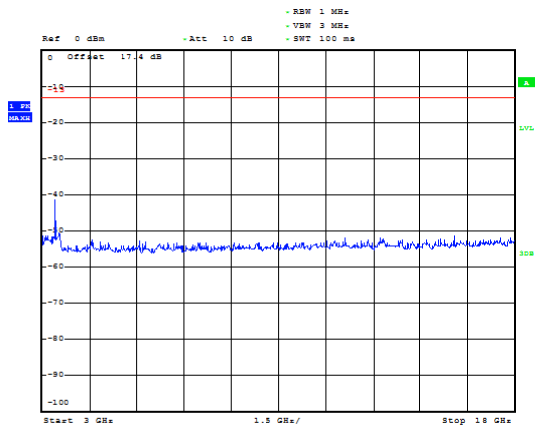

LTE Band 66 1.4MHz CH-Middle 3GHz~18GHz

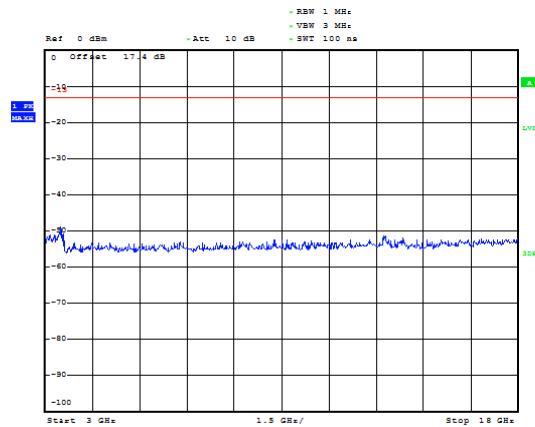



### LTE Band 66 1.4MHz CH-High 30MHz~1GHz

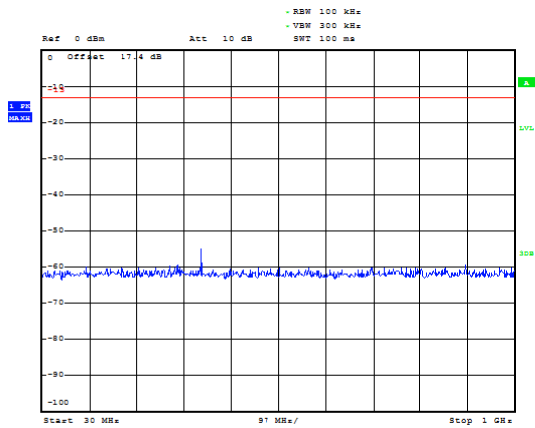

### LTE Band 66 3MHz CH-Low 30MHz~1GHz

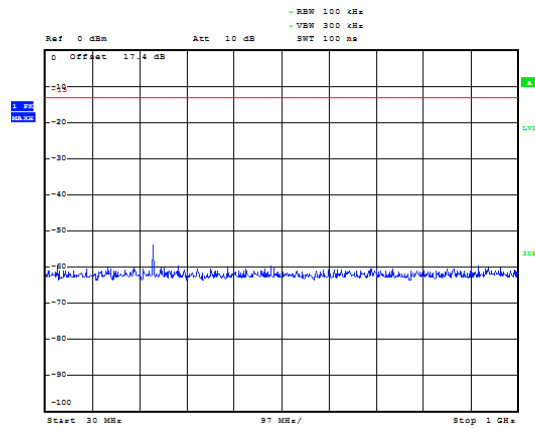

### LTE Band 66 1.4MHz CH-High 1GHz~3GHz

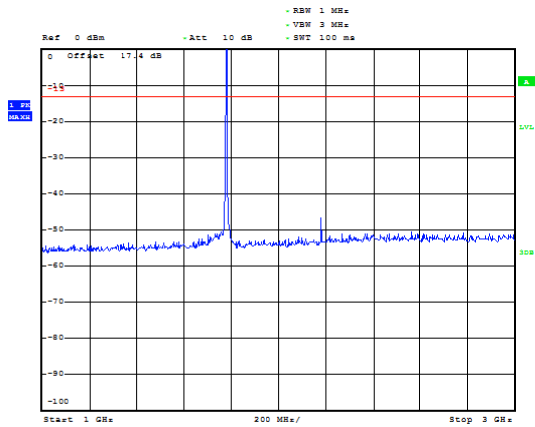

### LTE Band 66 3MHz CH-Low 1GHz~3GHz

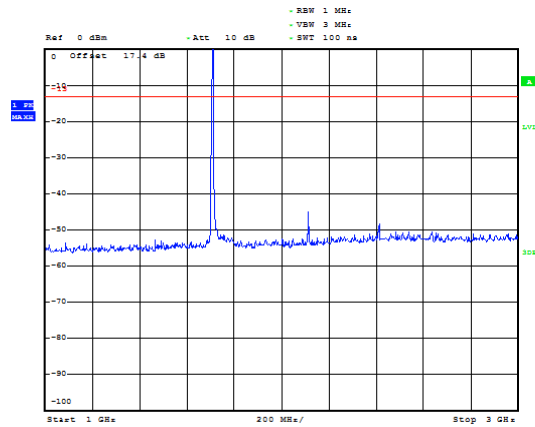

### LTE Band 66 1.4MHz CH-High 3GHz~18GHz

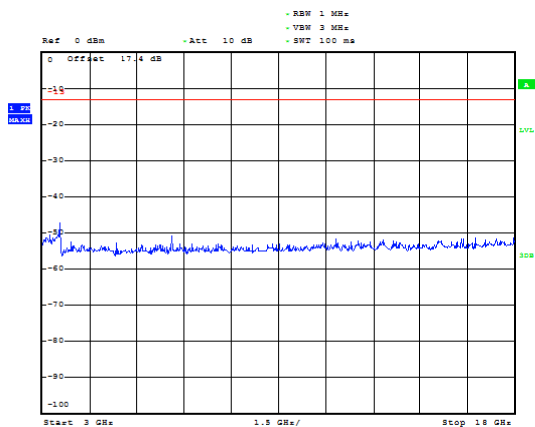

### LTE Band 66 3MHz CH-Low 3GHz~18GHz

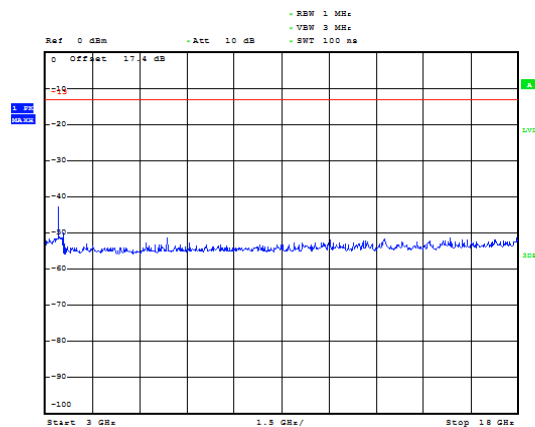



### LTE Band 66 3MHz CH-Middle 30MHz~1GHz

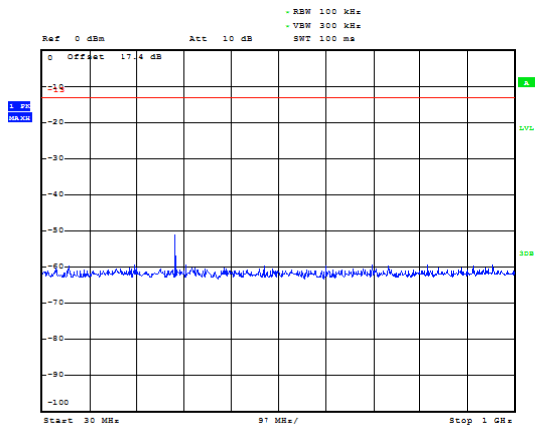

### LTE Band 66 3MHz CH-High 30MHz~1GHz

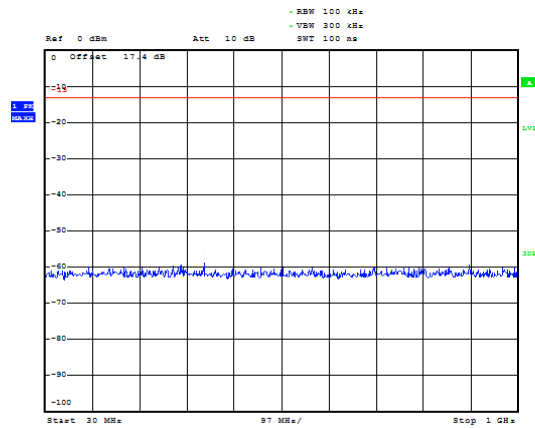

### LTE Band 66 3MHz CH-Middle 1GHz~3GHz

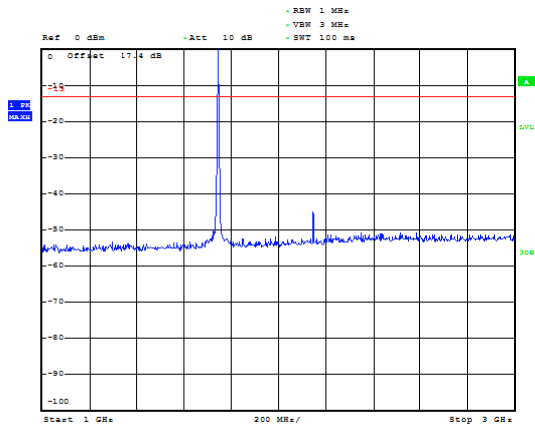

### LTE Band 66 3MHz CH-High 1GHz~3GHz

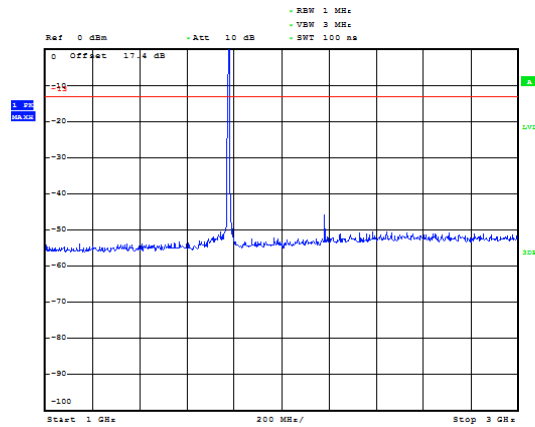

### LTE Band 66 3MHz CH-Middle 3GHz~18GHz

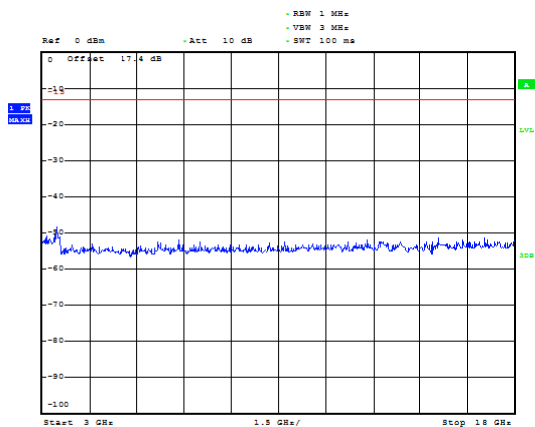

### LTE Band 66 3MHz CH-High 3GHz~18GHz

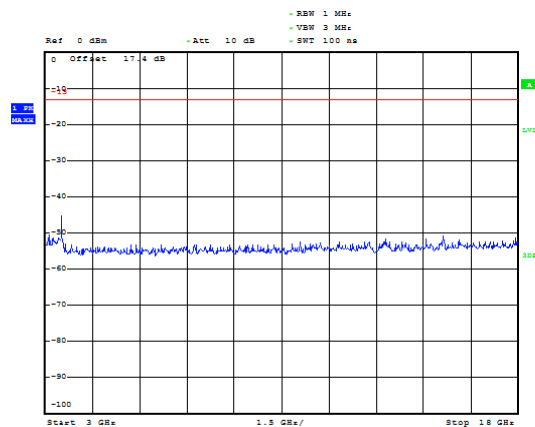





### LTE Band 66 5MHz CH-Low 30MHz~1GHz

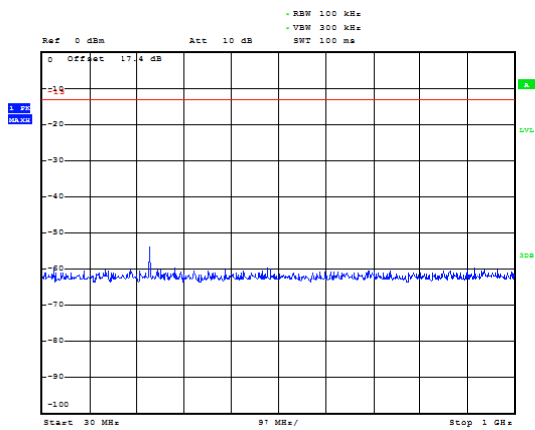

### LTE Band 66 5MHz CH-Middle 30MHz~1GHz

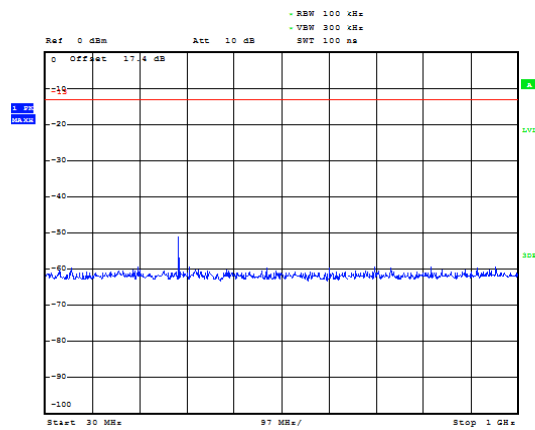

### LTE Band 66 5MHz CH-Low 1GHz~3GHz

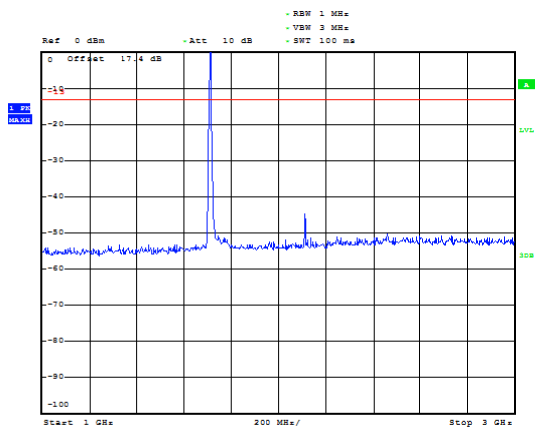

### LTE Band 66 5MHz CH-Middle 1GHz~3GHz

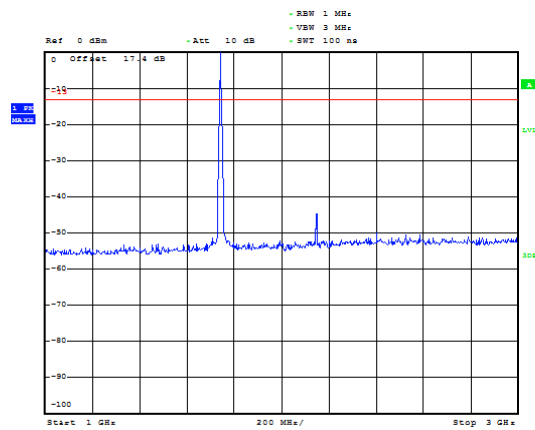

### LTE Band 66 5MHz CH-Low 3GHz~18GHz

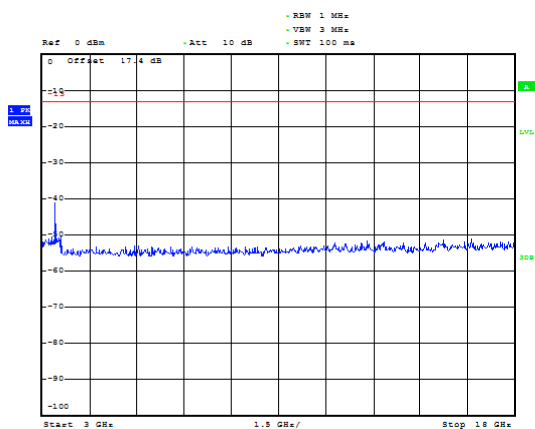

### LTE Band 66 5MHz CH-Middle 3GHz~18GHz

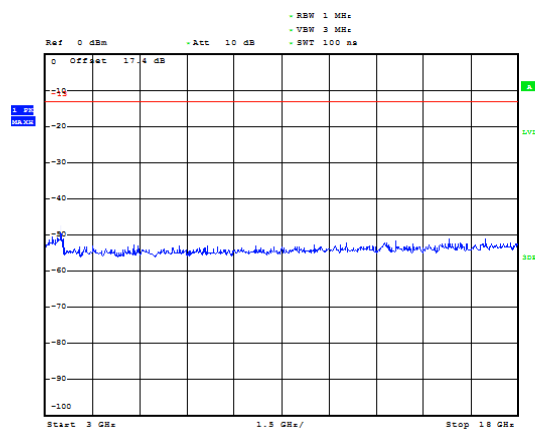



### LTE Band 66 5MHz CH-High 30MHz~1GHz

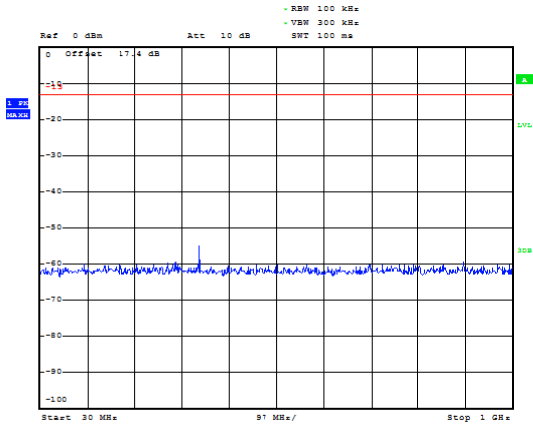

### LTE Band 66 10MHz CH-Low 30MHz~1GHz

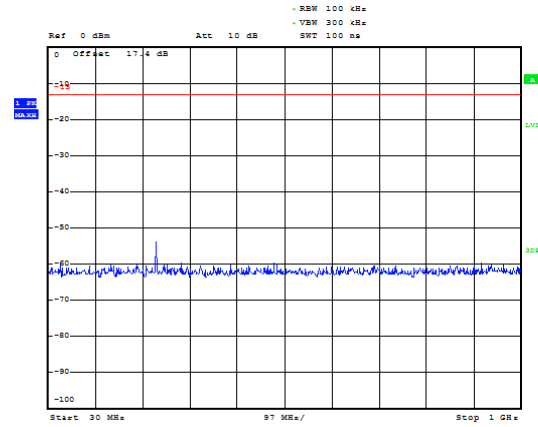

### LTE Band 66 5MHz CH-High 1GHz~3GHz

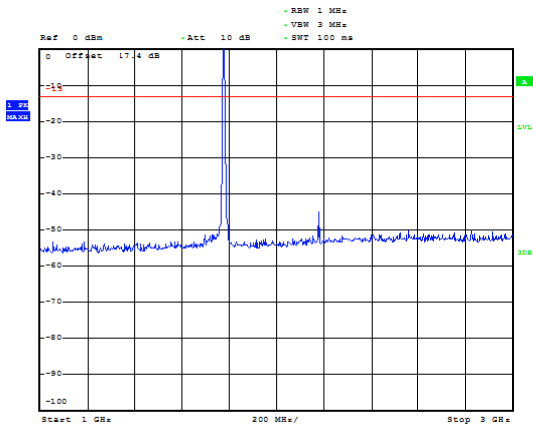

### LTE Band 66 10MHz CH-Low 1GHz~3GHz

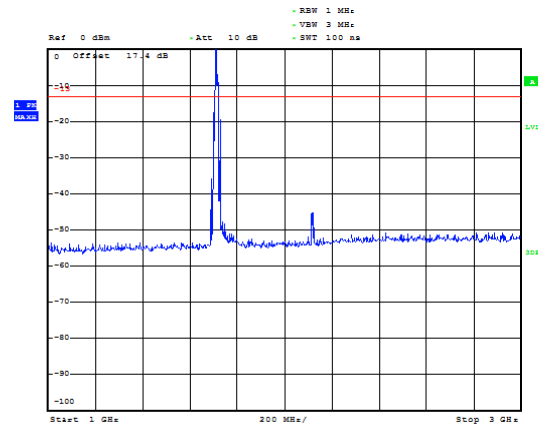

### LTE Band 66 5MHz CH-High 3GHz~18GHz

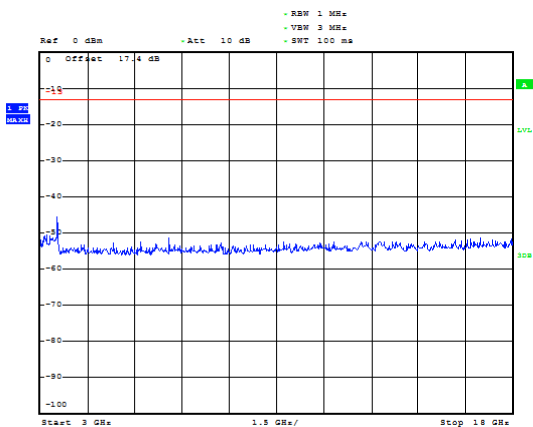

### LTE Band 66 10MHz CH-Low 3GHz~18GHz

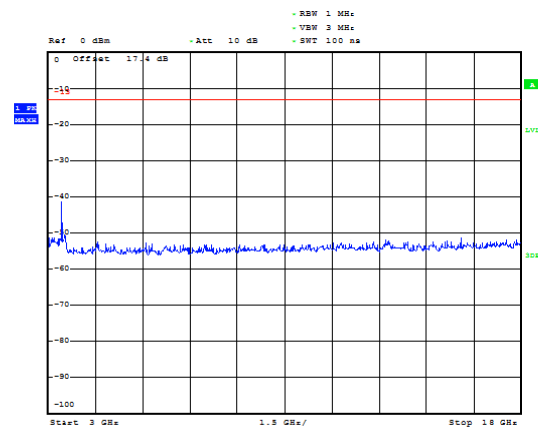



### LTE Band 66 10MHz CH-Middle 30MHz~1GHz

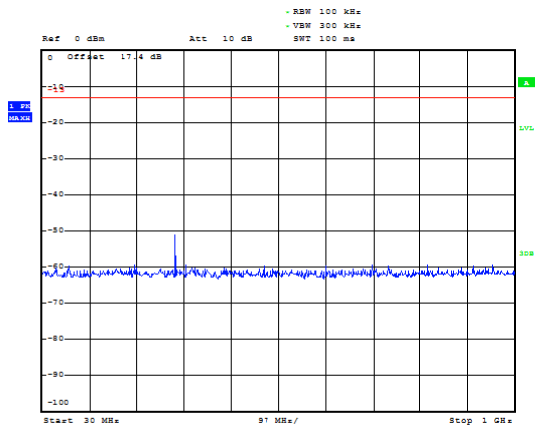

### LTE Band 66 10MHz CH-High 30MHz~1GHz

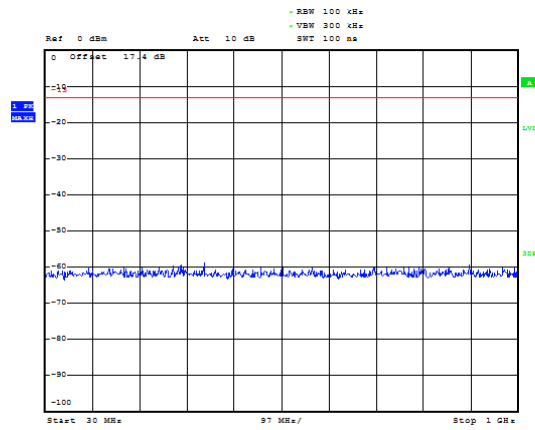

### LTE Band 66 10MHz CH-Middle 1GHz~3GHz

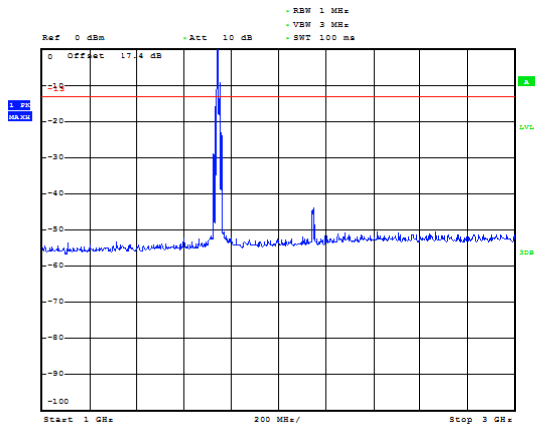

### LTE Band 66 10MHz CH-High 1GHz~3GHz

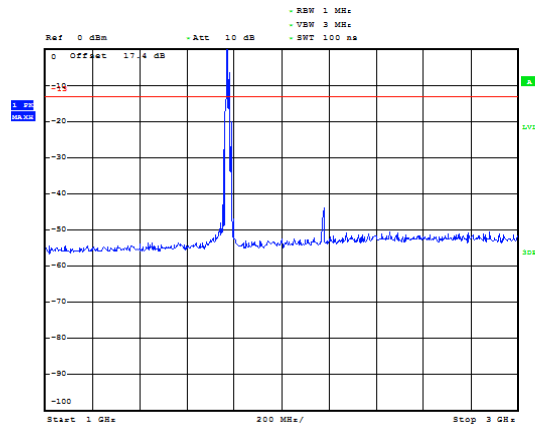

### LTE Band 66 10MHz CH-Middle 3GHz~18GHz

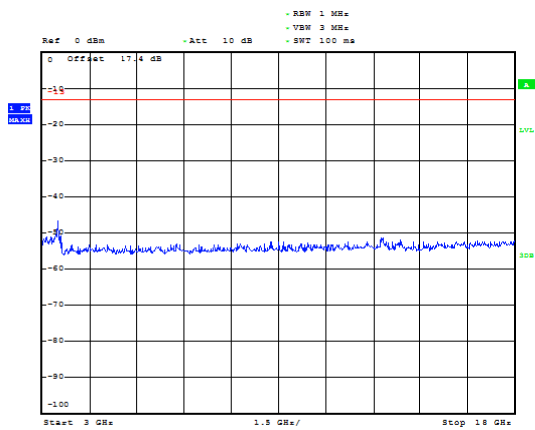

### LTE Band 66 10MHz CH-High 3GHz~18GHz

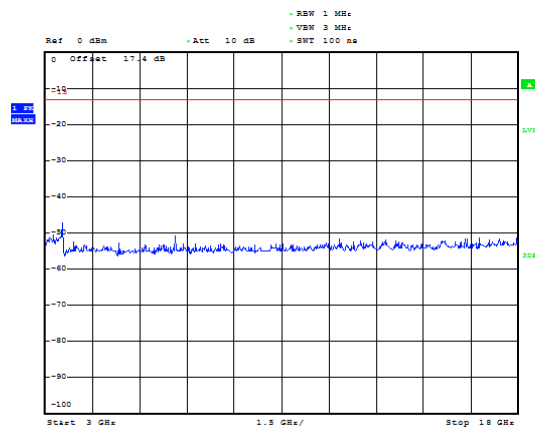





### LTE Band 66 15MHz CH-Low 30MHz~1GHz

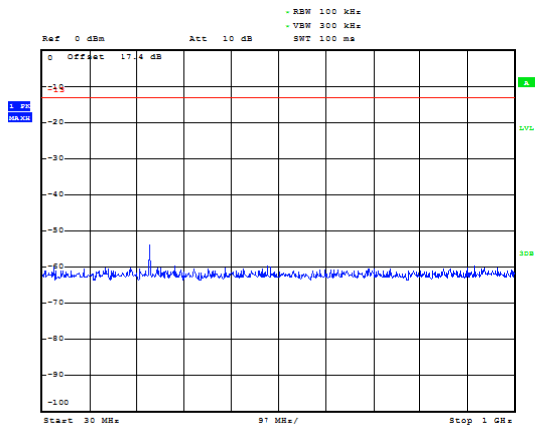

### LTE Band 66 15MHz CH-Middle 30MHz~1GHz

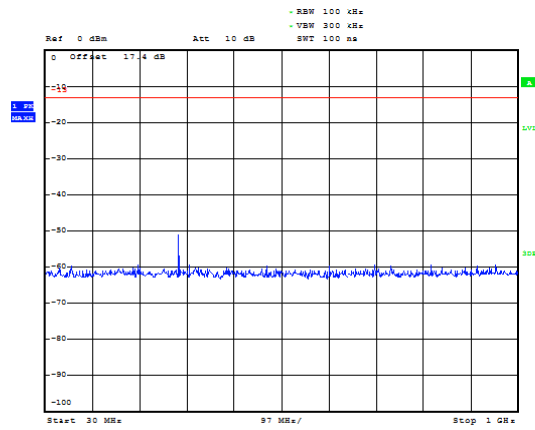

### LTE Band 66 15MHz CH-Low 1GHz~3GHz

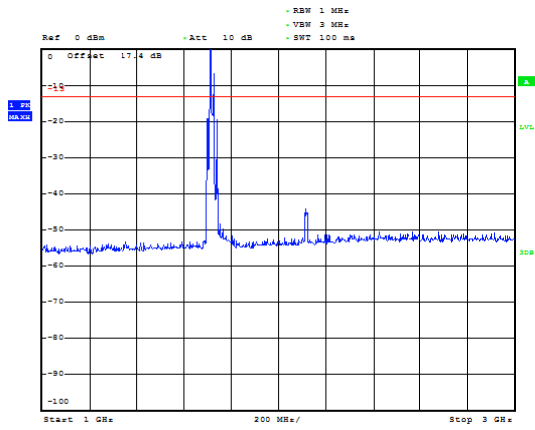

### LTE Band 66 15MHz CH-Middle 1GHz~3GHz

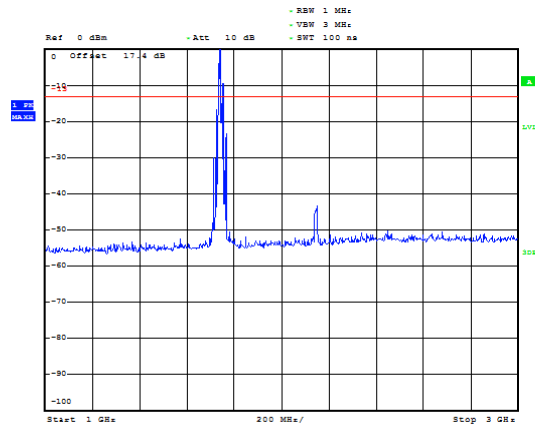

### LTE Band 66 15MHz CH-Low 3GHz~18GHz

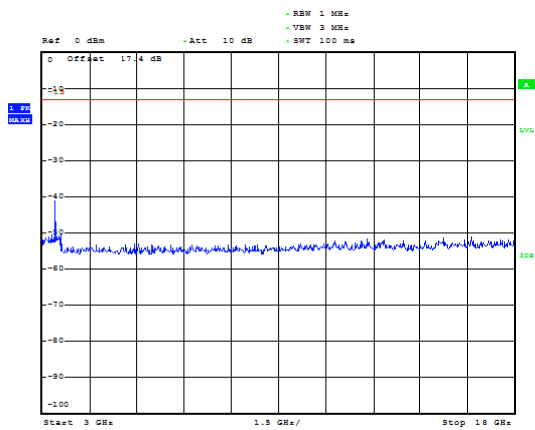

### LTE Band 66 15MHz CH-Middle 3GHz~18GHz

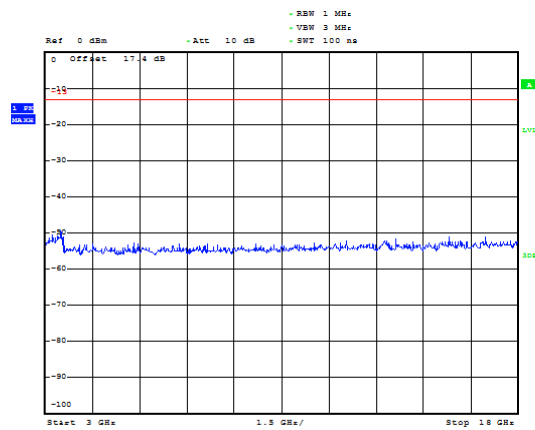



### LTE Band 66 15MHz CH-High 30MHz~1GHz

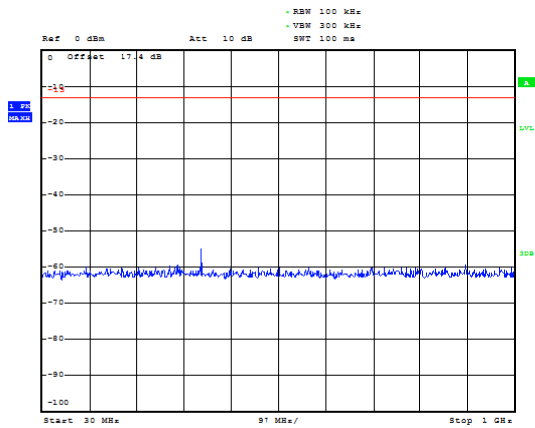

### LTE Band 66 20MHz CH-Low 30MHz~1GHz

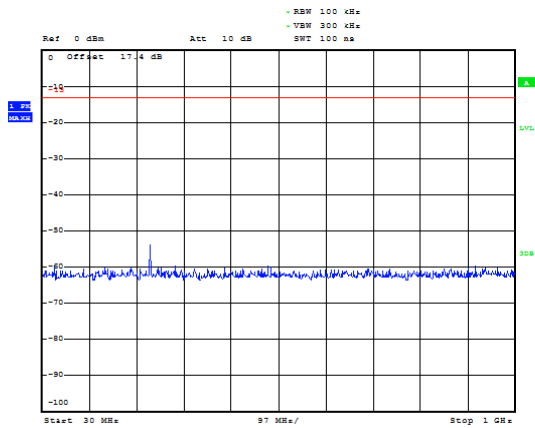

### LTE Band 66 15MHz CH-High 1GHz~3GHz

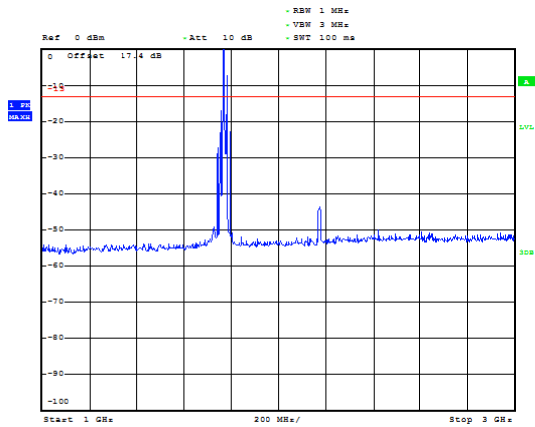

### LTE Band 66 20MHz CH-Low 1GHz~3GHz

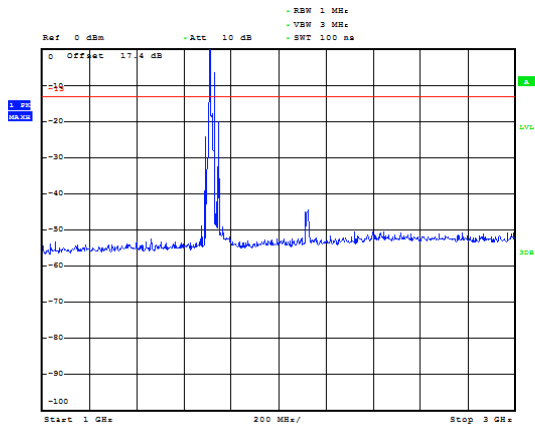

### LTE Band 66 15MHz CH-High 3GHz~18GHz

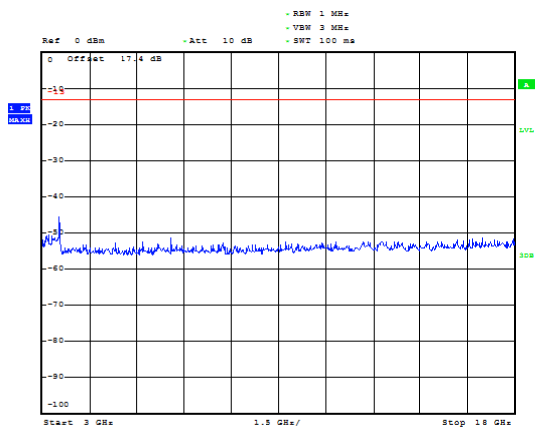

### LTE Band 66 20MHz CH-Low 3GHz~18GHz

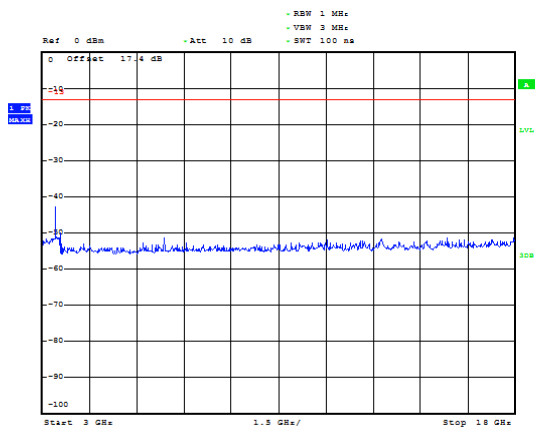



LTE Band 66 20MHz CH-Middle 30MHz~1GHz

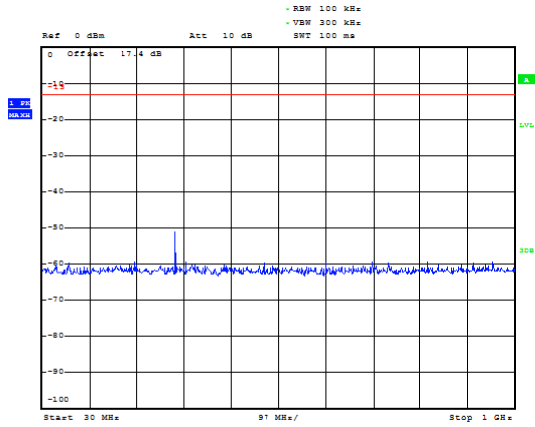

LTE Band 66 20MHz CH-High 30MHz~1GHz

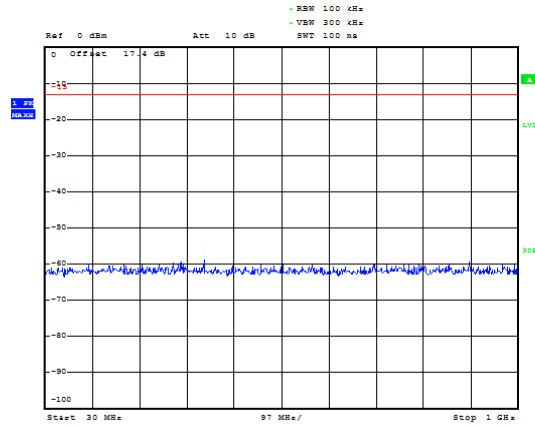

LTE Band 66 20MHz CH-Middle 1GHz~3GHz

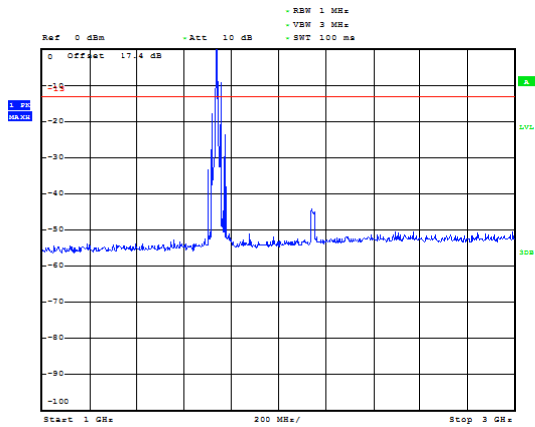

LTE Band 66 20MHz CH-High 1GHz~3GHz

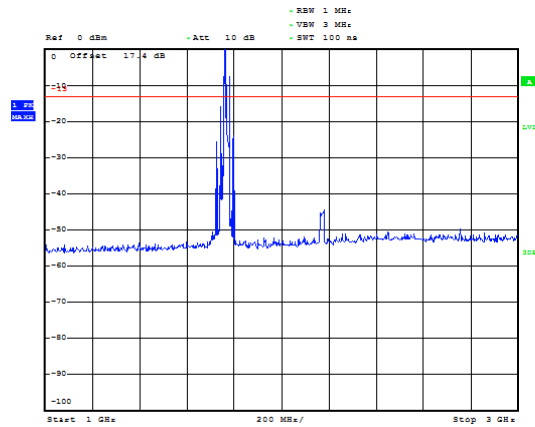

LTE Band 66 20MHz CH-Middle 3GHz~18GHz

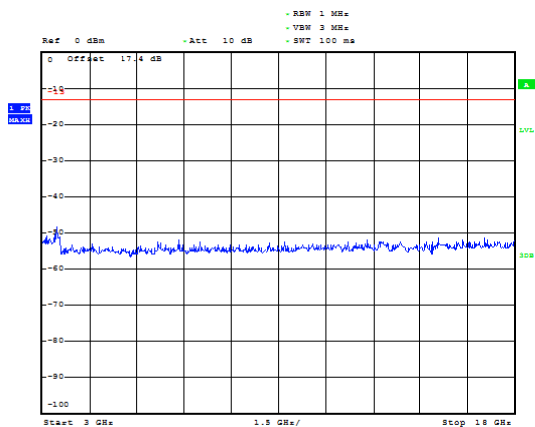

LTE Band 66 20MHz CH-High 3GHz~18GHz

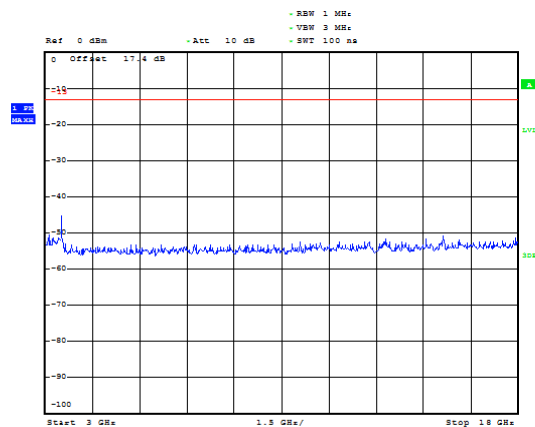



### LTE Band 71 5MHz CH-Low 30MHz~1GHz

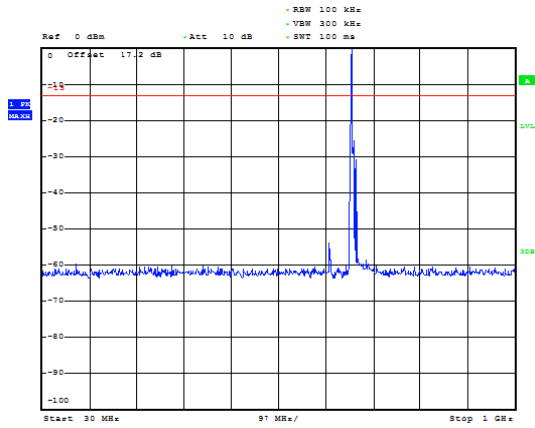

### LTE Band 71 5MHz CH-Low 1GHz~9GHz

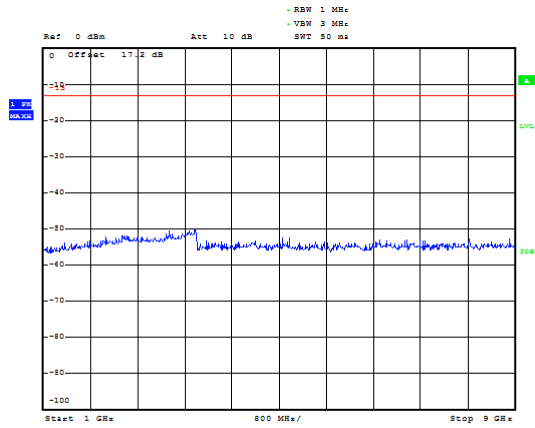

### LTE Band 71 5MHz CH-Middle 30MHz~1GHz

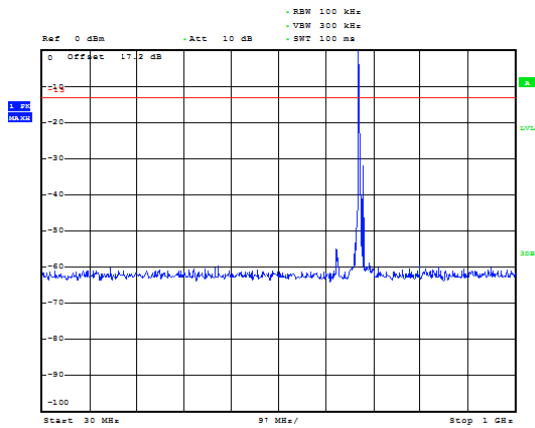

### LTE Band 71 5MHz CH-Middle 1GHz~9GHz

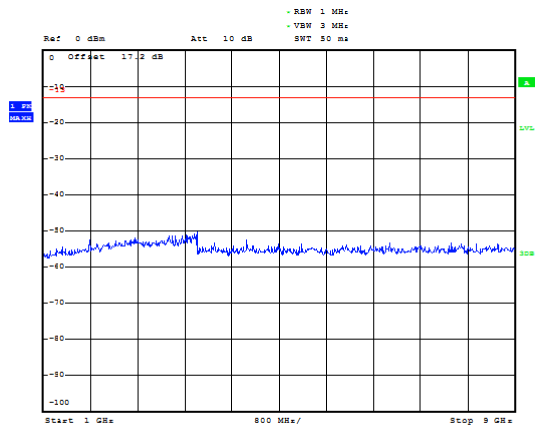

### LTE Band 71 5MHz CH-High 30MHz~1GHz

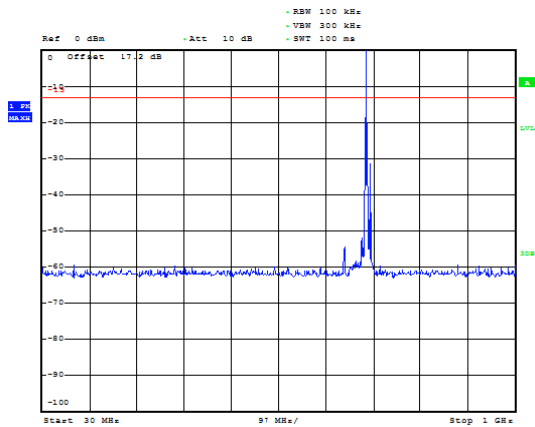

### LTE Band 71 5MHz CH-High 1GHz~9GHz

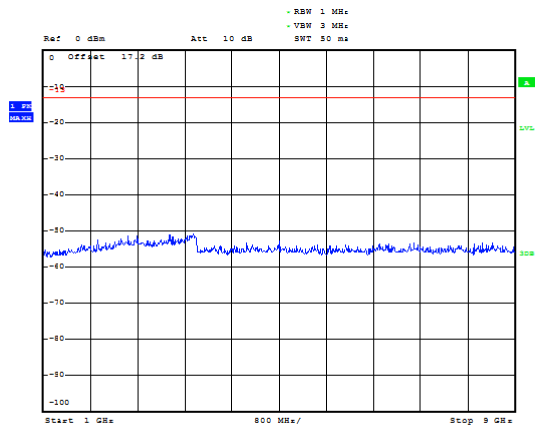





### LTE Band 71 10MHz CH-Low 30MHz~1GHz

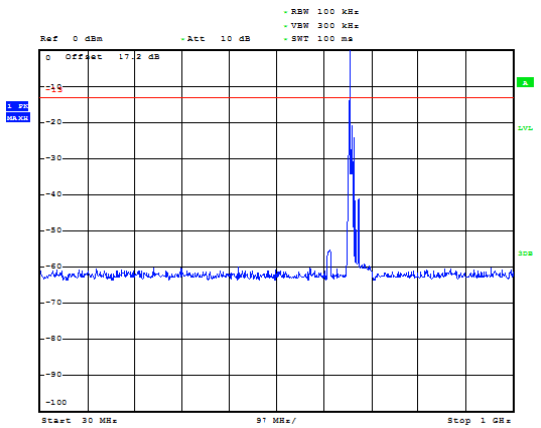

### LTE Band 71 10MHz CH-Low 1GHz~9GHz

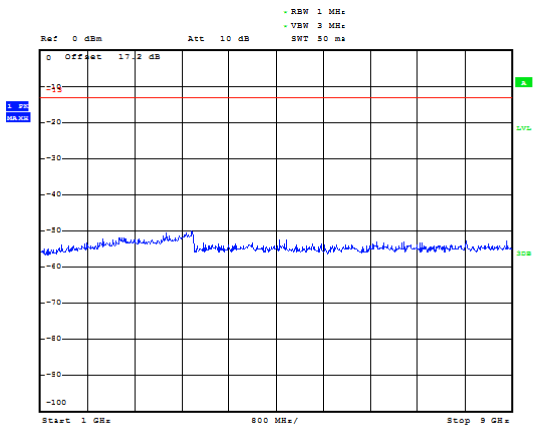

### LTE Band 71 10MHz CH-Middle 30MHz~1GHz

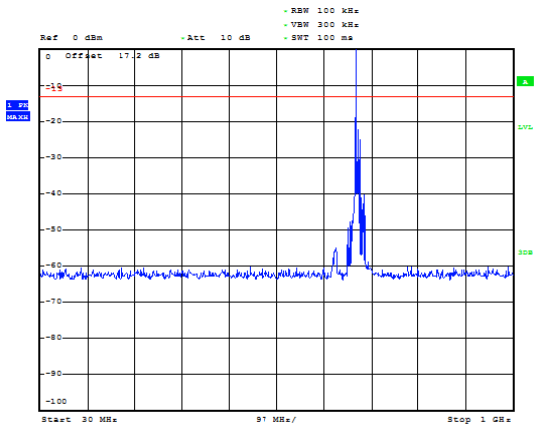

### LTE Band 71 10MHz CH-Middle 1GHz~9GHz

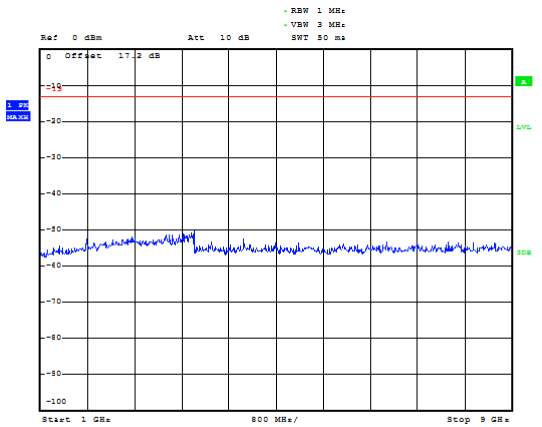

### LTE Band 71 10MHz CH-High 30MHz~1GHz

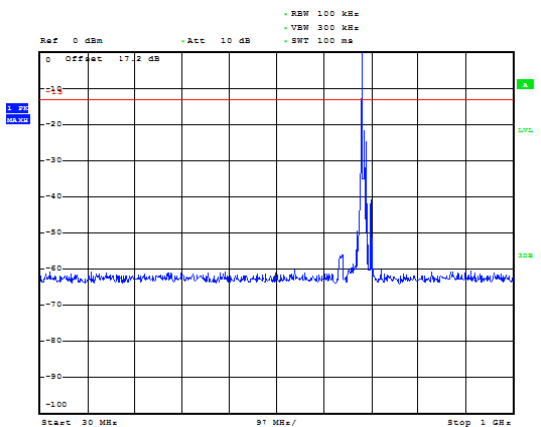

### LTE Band 71 10MHz CH-High 1GHz~9GHz

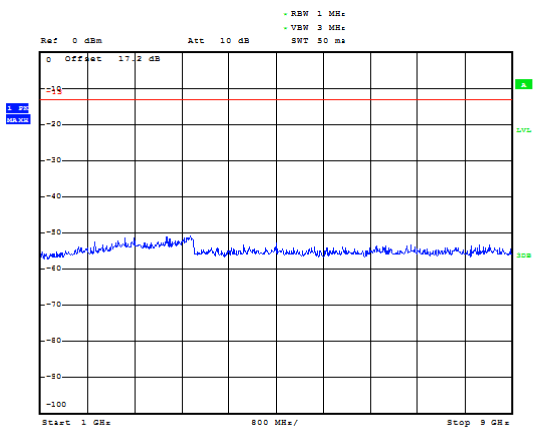



LTE Band 71 15MHz CH-Low 30MHz~1GHz

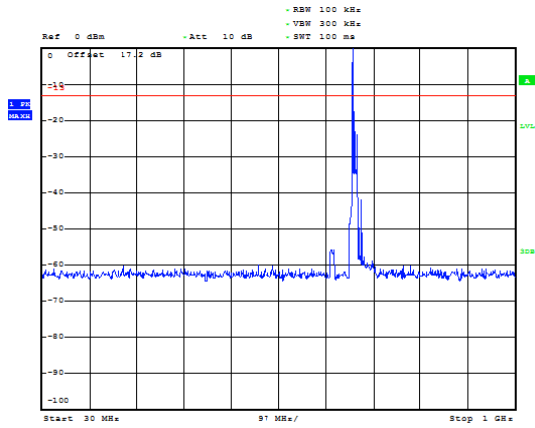

LTE Band 71 15MHz CH-Low 1GHz~9GHz

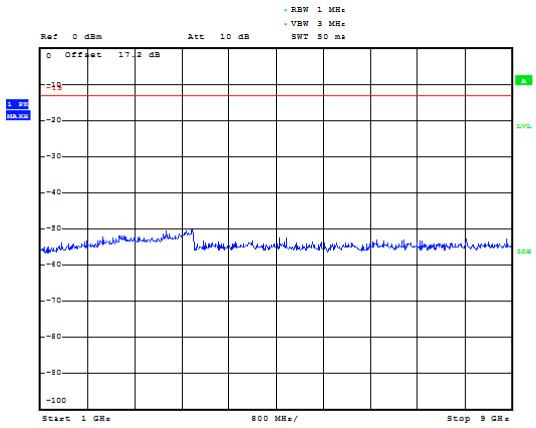

LTE Band 71 15MHz CH-Middle 30MHz~1GHz

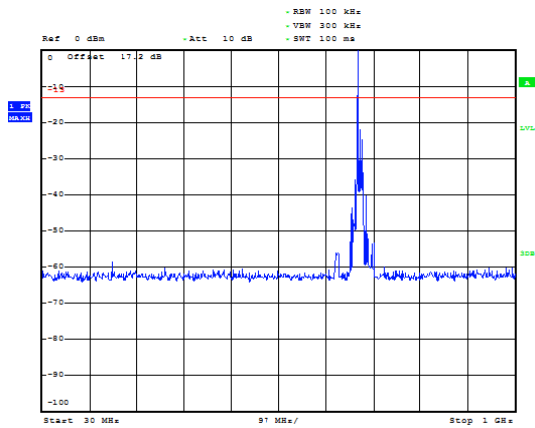

LTE Band 71 15MHz CH-Middle 1GHz~9GHz

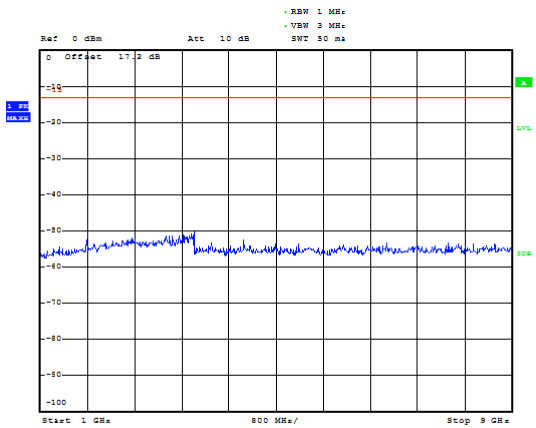

LTE Band 71 15MHz CH-High 30MHz~1GHz

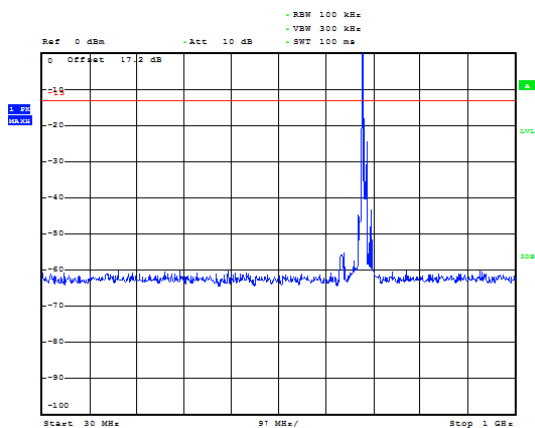

LTE Band 71 15MHz CH-High 1GHz~9GHz

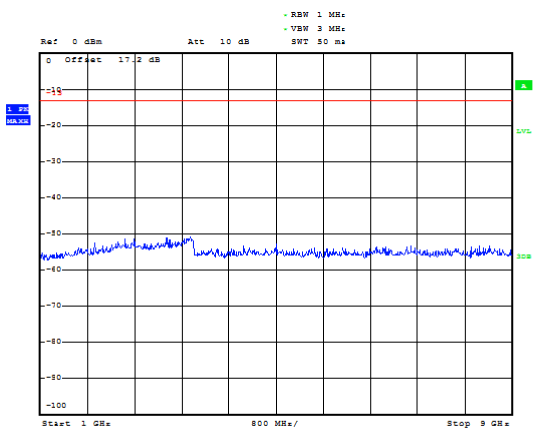

LTE Band 71 20MHz CH-Low 30MHz~1GHz

LTE Band 71 20MHz CH-Low 1GHz~9GHz

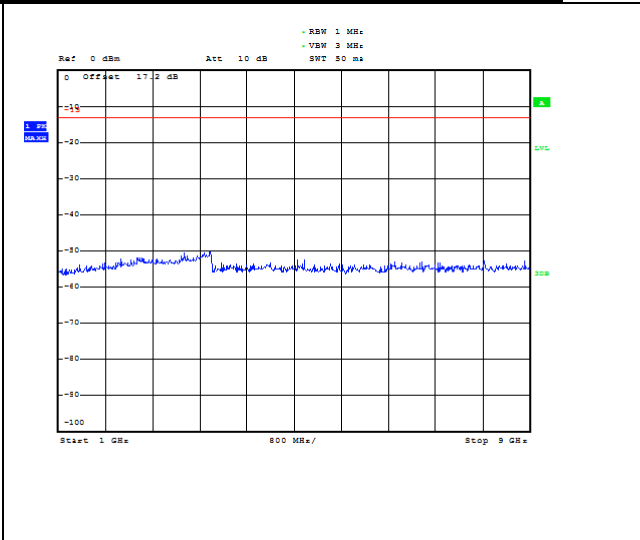
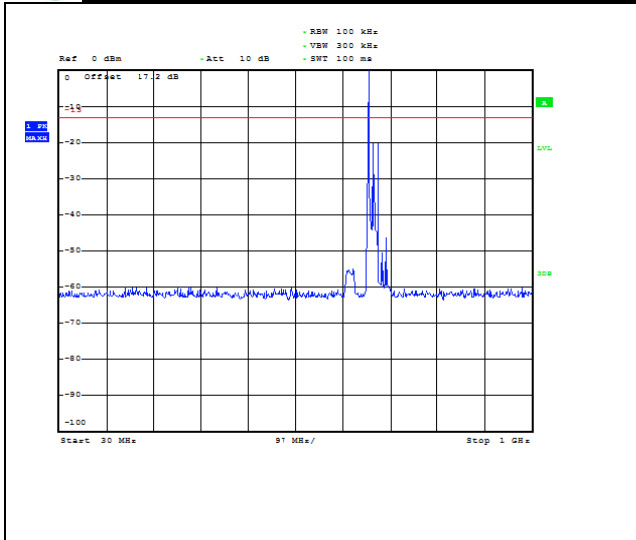

LTE Band 71 20MHz CH-Middle 30MHz~1GHz

LTE Band 71 20MHz CH-Middle 1GHz~9GHz

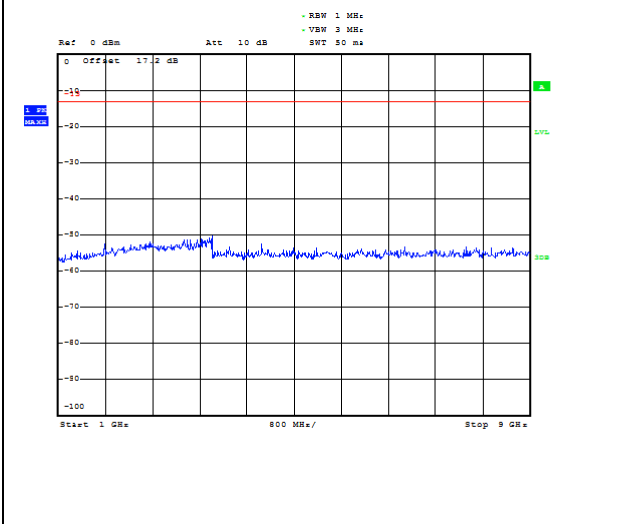
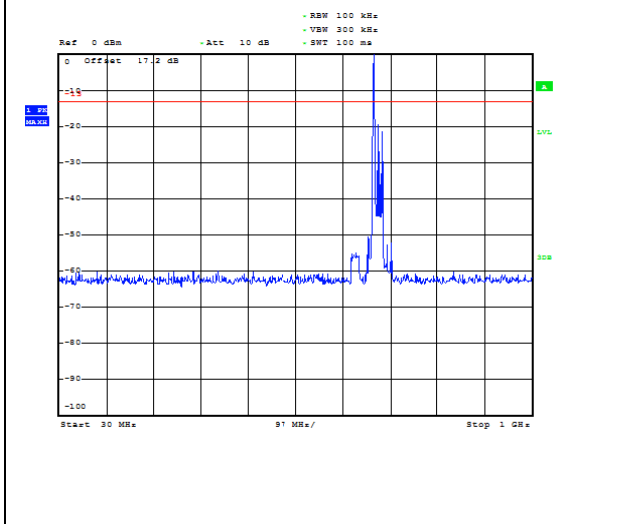

LTE Band 71 20MHz CH-High 30MHz~1GHz

LTE Band 71 20MHz CH-High 1GHz~9GHz

## 5.8 Radiates Spurious Emission

### Ambient condition

Temperature	Relative humidity	Pressure
23°C ~25°C	45%~50%	101.5kPa

### Method of Measurement

1. The testing follows FCC KDB 971168 D01 v03r01 Section 5.8 and ANSI C63.26 (2015).
  2. The EUT is placed on a turntable 0.8 meters above the ground in the chamber, 3 meter away from the antenna. The maximal emission value is acquired by adjusting the antenna height, polarisation and turntable azimuth. Normally, the height range of antenna is 1 m to 4 m, the azimuth range of turntable is 0° to 360°, and the receive antenna has two polarizations Vertical (V) and Horizontal (H).
  3. A log-periodic antenna or double-ridged waveguide horn antenna shall be substituted in place of the EUT. The log-periodic antenna will be driven by a signal generator and the level will be adjusted till the same power value on the spectrum analyzer or receiver. The level of the spurious emissions can be calculated through the level of the signal generator, cable loss, the gain of the substitution antenna and the reading of the spectrum analyzer or receiver.
  4. The EUT is then put into continuously transmitting mode at its maximum power level during the test. Set Test Receiver or Spectrum RBW=1MHz, VBW=3MHz, And the maximum value of the receiver should be recorded as (Pr).
  5. The EUT shall be replaced by a substitution antenna. In the chamber, an substitution antenna for the frequency band of interest is placed at the reference point of the chamber. An RF Signal source for the frequency band of interest is connected to the substitution antenna with a cable that has been constructed to not interfere with the radiation pattern of the antenna. A power (PMea) is applied to the input of the substitution antenna, and adjust the level of the signal generator output until the value of the receiver reach the previously recorded (Pr). The power of signal source (PMea) is recorded. The test should be performed by rotating the test item and adjusting the receiving antenna polarization.
  6. A amplifier should be connected to the Signal Source output port. And the cable should be connect between the Amplifier and the Substitution Antenna. The cable loss (Pcl) ,the Substitution Antenna Gain (Ga) and the Amplifier Gain (PAg) should be recorded after test.
  7. The measurement results are obtained as described below:  

$$\text{Power(EIRP)} = \text{PMea} - \text{PAg} - \text{Pcl} + \text{Ga}$$
 The measurement results are amend as described below:  

$$\text{Power(EIRP)} = \text{PMea} - \text{Pcl} + \text{Ga}$$
  8. This value is EIRP since the measurement is calibrated using an antenna of known gain (2.15 dBi) and known input power. ERP can be calculated from EIRP by subtracting the gain of the dipole,  $\text{ERP} = \text{EIRP} - 2.15\text{dBi}$ .
- The modulation mode and RB allocation refer to section 5.1, using the maximum output power configuration.

**Test setup**

**30MHz~~~ 1GHz**

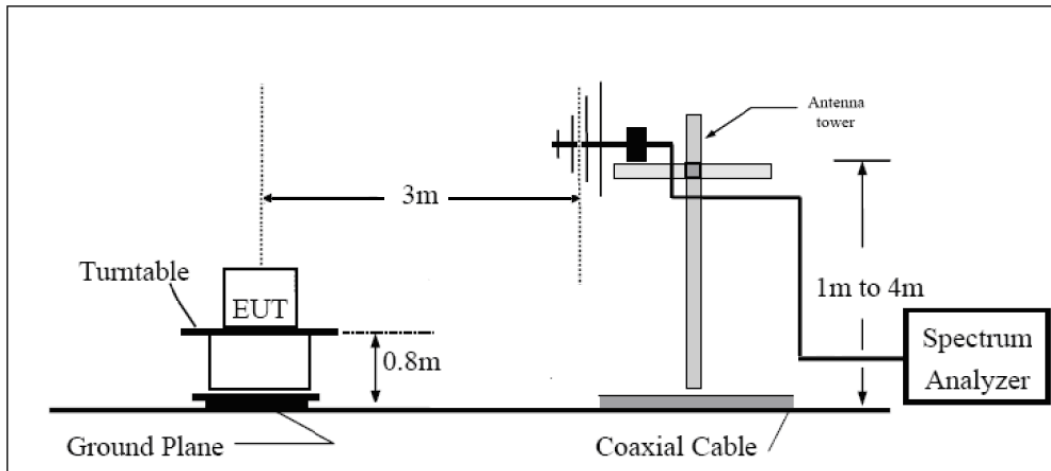

**Above 1GHz**

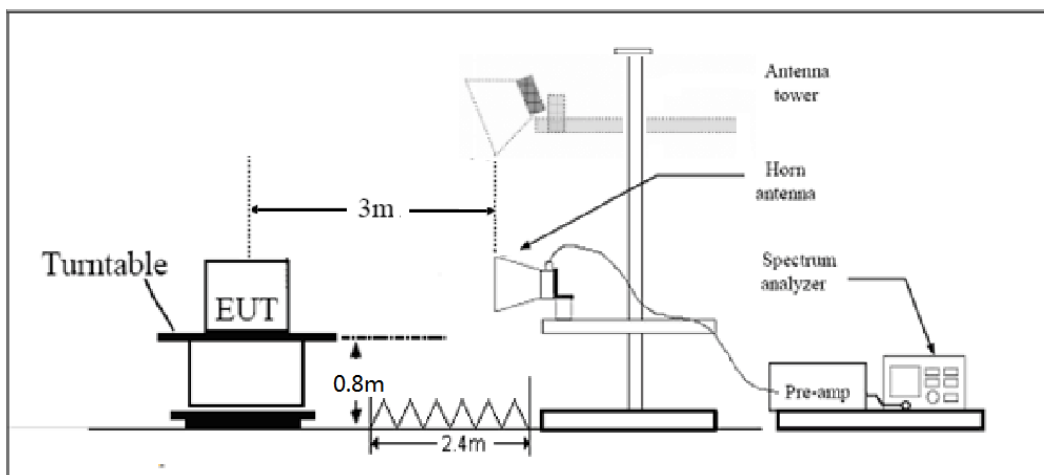

Note: Area side:2.4mX3.6m

The radiated emission was measured in the following position: EUT stand-up position (Z axis), lie-down position (X, Y axis). The worst emission was found in lie-down position (X axis) and the worst case was recorded.

**Limits**

Rule Part 27.53(h) specifies that “for operations in the 1695-1710 MHz, 1710-1755 MHz, 1755-1780 MHz, 1915-1920 MHz, 1995-2000 MHz, 2000-2020 MHz, 2110-2155 MHz, 2155-2180 MHz, and 2180-2200 bands, the power of any emission outside a licensee's frequency block shall be attenuated below the transmitter power (P) in watts by at least 43 + 10 log<sub>10</sub> (P) dB..”

Rule Part 27.53 (g) For operations in the 600 MHz band and the 698-746 MHz band, the power of any emission outside a licensee's frequency band(s) of operation shall be attenuated below the transmitter power (P) within the licensed band(s) of operation, measured in watts, by at least 43 + 10 log (P) dB. Compliance with this provision is based on the use of measurement instrumentation employing a resolution bandwidth of 100 kilohertz or greater. However, in the 100 kilohertz bands

immediately outside and adjacent to a licensee's frequency block, a resolution bandwidth of at least 30 kHz may be employed.

Rule Part 27.53(f) For operations in the 746-758 MHz, 775-788 MHz, and 805-806 MHz bands, emissions in the band 1559-1610 MHz shall be limited to -70 dBW/MHz equivalent isotropically radiated power (EIRP) for wideband signals, and -80 dBW EIRP for discrete emissions of less than 700 Hz bandwidth. For the purpose of equipment authorization, a transmitter shall be tested with an antenna that is representative of the type that will be used with the equipment in normal operation.

Part 27.53 (c) For operations in the 746-758 MHz band and the 776-788 MHz band, the power of any emission outside the licensee's frequency band(s) of operation shall be attenuated below the transmitter power (P) within the licensed band(s) of operation, measured in watts, in accordance with the following:

- (1) On any frequency outside the 746-758 MHz band, the power of any emission shall be attenuated outside the band below the transmitter power (P) by at least  $43 + 10 \log (P)$  dB;
- (2) On any frequency outside the 776-788 MHz band, the power of any emission shall be attenuated outside the band below the transmitter power (P) by at least  $43 + 10 \log (P)$  dB;
- (3) On all frequencies between 763-775 MHz and 793-805 MHz, by a factor not less than  $76 + 10 \log (P)$  dB in a 6.25 kHz band segment, for base and fixed stations;
- (4) On all frequencies between 763-775 MHz and 793-805 MHz, by a factor not less than  $65 + 10 \log (P)$  dB in a 6.25 kHz band segment, for mobile and portable stations;
- (5) Compliance with the provisions of paragraphs (c)(1) and (c)(2) of this section is based on the use of measurement instrumentation employing a resolution bandwidth of 100 kHz or greater. However, in the 100 kHz bands immediately outside and adjacent to the frequency block, a resolution bandwidth of at least 30 kHz may be employed;

Part 27.53(a)/(h)/(g) Limit		-13 dBm
Part 27.53(f) Limit	Limit out of the band 1559-1610 MHz	-13 dBm
	Limit in the band 1559-1610 MHz	-40 dBm

**Measurement Uncertainty**

The assessed measurement uncertainty to ensure 95% confidence level for the normal distribution is with the coverage factor  $k = \pm 1.96$ ,  $U = \pm 3.55$  dB.

**Test Result**

Sweep the whole frequency band through the range from 30MHz to the 10th harmonic of the carrier, the emissions below the noise floor will not be recorded in the report.

**WCDMA Band IV CH-Middle**

Harmonic	Frequency (MHz)	SG (dBm)	Cable Loss (dB)	Gain (dBi)	Antenna Polarization	EIRP Level (dBm)	Limit (dBm)	Margin (dB)	Azimuth (deg)
2	3465.2	-58.16	2.6	10.75	Horizontal	-50.01	-13.00	37.01	90
3	5197.8	-62.42	2.4	11.05	Horizontal	-53.77	-13.00	40.77	135
4	6930.4	-52.92	4.5	11.15	Horizontal	-46.27	-13.00	33.27	45
5	8663.0	-55.39	5.1	11.35	Horizontal	-49.14	-13.00	36.14	0
6	10395.6	-55.25	5.3	11.95	Horizontal	-48.60	-13.00	35.60	225
7	12128.2	-54.80	5.5	13.55	Horizontal	-46.75	-13.00	33.75	270
8	13860.8	-52.18	6.3	13.75	Horizontal	-44.73	-13.00	31.73	180
9	15593.4	-53.33	6.7	13.85	Horizontal	-46.18	-13.00	33.18	225
10	17326.0	-51.33	6.8	14.25	Horizontal	-43.88	-13.00	30.88	315

Note: 1. The other Spurious RF Radiated emissions level is no more than noise floor.  
 2. The worst emission was found in the antenna is Horizontal position.

**LTE Band 4 QPSK 5MHz CH-Middle, RB 1**

Harmonic	Frequency (MHz)	SG (dBm)	Cable Loss (dB)	Gain (dBi)	Antenna Polarization	EIRP Level (dBm)	Limit (dBm)	Margin (dB)	Azimuth (deg)
2	3460.5	-54.46	2.6	10.75	Horizontal	-46.31	-13.00	33.31	90
3	5191.5	-59.67	2.4	11.05	Horizontal	-51.02	-13.00	38.02	315
4	6930.0	-45.66	4.5	11.15	Horizontal	-39.01	-13.00	26.01	225
5	8662.5	-56.26	5.1	11.35	Horizontal	-50.01	-13.00	37.01	270
6	10395.0	-55.48	5.3	11.95	Horizontal	-48.83	-13.00	35.83	90
7	12127.5	-53.74	5.5	13.55	Horizontal	-45.69	-13.00	32.69	135
8	13860.0	-52.20	6.3	13.75	Horizontal	-44.75	-13.00	31.75	45
9	15592.5	-53.93	6.7	13.85	Horizontal	-46.78	-13.00	33.78	45
10	17325.0	-47.52	6.8	14.25	Horizontal	-40.07	-13.00	27.07	0

Note: 1. The other Spurious RF Radiated emissions level is no more than noise floor.  
 2. The worst emission was found in the antenna is Horizontal position.

**LTE Band 12 QPSK 5MHz CH-Middle, RB 1**

Harmonic	Frequency (MHz)	SG (dBm)	Cable Loss (dB)	Gain (dBi)	Antenna Polarization	ERP Level (dBm)	Limit (dBm)	Margin (dB)	Azimuth (deg)
2	1415.0	-67.96	2.00	10.75	Horizontal	-61.36	-13.00	48.36	180
3	2122.5	-56.18	2.51	11.05	Horizontal	-49.79	-13.00	36.79	225
4	2830.0	-57.29	4.20	11.15	Horizontal	-52.49	-13.00	39.49	315
5	3537.5	-52.01	5.20	11.15	Horizontal	-48.21	-13.00	35.21	135
6	4245.0	-53.13	5.50	11.95	Horizontal	-48.83	-13.00	35.83	0
7	4952.5	-61.19	5.70	13.55	Horizontal	-55.49	-13.00	42.49	45
8	5660.0	-60.70	6.30	13.75	Horizontal	-55.40	-13.00	42.40	315
9	6367.5	-56.87	6.80	13.85	Horizontal	-51.97	-13.00	38.97	180
10	7075.0	-55.40	6.90	14.25	Horizontal	-50.20	-13.00	37.20	135

Note: 1.The other Spurious RF Radiated emissions level is no more than noise floor.  
2. The worst emission was found in the antenna is Horizontal position.

**LTE Band 13 QPSK 5MHz CH-Middle, RB 1**

Harmonic	Frequency (MHz)	SG (dBm)	Cable Loss (dB)	Gain (dBi)	Antenna Polarization	ERP Level (dBm)	Limit (dBm)	Margin (dB)	Azimuth (deg)
2	1564.0	-65.63	2.00	10.75	Horizontal	-59.03	-40.00	19.03	135
3	2346.0	-53.93	2.51	11.05	Horizontal	-47.54	-13.00	34.54	45
4	3128.0	-61.26	4.20	11.15	Horizontal	-56.46	-13.00	43.46	90
5	3910.0	-60.06	5.20	11.15	Horizontal	-56.26	-13.00	43.26	135
6	4692.0	-59.82	5.50	11.95	Horizontal	-55.52	-13.00	42.52	180
7	5474.0	-61.02	5.70	13.55	Horizontal	-55.32	-13.00	42.32	225
8	6256.0	-59.25	6.30	13.75	Horizontal	-53.95	-13.00	40.95	315
9	7038.0	-54.98	6.80	13.85	Horizontal	-50.08	-13.00	37.08	270
10	7820.0	-54.13	6.90	14.25	Horizontal	-48.93	-13.00	35.93	135

Note: 1.The other Spurious RF Radiated emissions level is no more than noise floor.  
2. The worst emission was found in the antenna is Horizontal position.



**LTE Band 66 QPSK 5MHz CH-Middle, RB 1**

Harmonic	Frequency (MHz)	SG (dBm)	Cable Loss (dB)	Gain (dBi)	Antenna Polarization	EIRP Level (dBm)	Limit (dBm)	Margin (dB)	Azimuth (deg)
2	3460.5	-60.24	2.6	10.75	Horizontal	-52.09	-13.00	39.09	180
3	5191.5	-63.42	2.4	11.05	Horizontal	-54.77	-13.00	41.77	135
4	6930	-50.34	4.5	11.15	Horizontal	-43.69	-13.00	30.69	90
5	8662.5	-56.33	5.1	11.35	Horizontal	-50.08	-13.00	37.08	45
6	10395	-51.45	5.3	11.95	Horizontal	-44.80	-13.00	31.80	315
7	12127.5	-54.58	5.5	13.55	Horizontal	-46.53	-13.00	33.53	270
8	13860	-52.05	6.3	13.75	Horizontal	-44.60	-13.00	31.60	90
9	15592.5	-54.03	6.7	13.85	Horizontal	-46.88	-13.00	33.88	135
10	17325	-50.05	6.8	14.25	Horizontal	-42.60	-13.00	29.60	0

Note: 1.The other Spurious RF Radiated emissions level is no more than noise floor.

2. The worst emission was found in the antenna is Horizontal position.

**LTE Band 71 QPSK 5MHz CH-Middle, RB 1**

Harmonic	Frequency (MHz)	SG (dBm)	Cable Loss (dB)	Gain (dBi)	Antenna Polarization	ERP Level (dBm)	Limit (dBm)	Margin (dB)	Azimuth (deg)
2	1361.0	-56.30	2.00	10.75	Horizontal	-47.55	-13.00	34.55	135
3	2041.5	-60.98	2.51	11.05	Horizontal	-52.44	-13.00	39.44	315
4	2722.0	-65.41	4.20	11.15	Horizontal	-58.46	-13.00	45.46	90
5	3402.5	-63.41	5.20	11.15	Horizontal	-57.46	-13.00	44.46	90
6	4083.0	-62.97	5.50	11.95	Horizontal	-56.52	-13.00	43.52	135
7	4763.5	-63.39	5.70	13.55	Horizontal	-55.54	-13.00	42.54	45
8	5444.0	-61.71	6.30	13.75	Horizontal	-54.26	-13.00	41.26	225
9	6124.5	-61.77	6.80	13.85	Horizontal	-54.72	-13.00	41.72	315
10	6805.0	-60.38	6.90	14.25	Horizontal	-53.03	-13.00	40.03	90

Note: 1.The other Spurious RF Radiated emissions level is no more than noise floor.

2. The worst emission was found in the antenna is Horizontal position.

## 6 Main Test Instruments

Name	Manufacturer	Type	Serial Number	Calibration Date	Expiration Date
Base Station Simulator	R&S	CMW500	113824	2019-05-19	2020-05-18
Power Splitter	Hua Xiang	SHX-GF2-2-13	10120101	/	/
Spectrum Analyzer	Key sight	N9010A	MY50210259	2019-05-19	2020-05-18
Signal Analyzer	R&S	FSV30	100815	2018-12-16	2019-12-15
Loop Antenna	SCHWARZBECK	FMZB1519	1519-047	2017-09-26	2019-09-25
Trilog Antenna	SCHWARZBECK	VUBL 9163	9163-201	2017-11-18	2019-11-17
Horn Antenna	R&S	HF907	100126	2018-07-07	2020-07-06
Horn Antenna	ETS-Lindgren	3160-09	00102643	2018-06-20	2020-06-19
Horn Antenna	STEATITE	QSH-SL-26-40-K-15	16779	2017-07-20	2019-07-19
Signal generator	R&S	SMB 100A	102594	2019-05-19	2020-05-18
Climatic Chamber	ESPEC	SU-242	93000506	2017-12-17	2020-12-16
Preamplifier	R&S	SCU18	102327	2019-05-19	2020-05-18
MOB COMMS DC SUPPLY	Keysight	66319D	MY43004105	2019-05-19	2020-05-18
RF Cable	Agilent	SMA 15cm	0001	2019-06-14	2019-09-13
Software	R&S	EMC32	9.26.0	/	/

\*\*\*\*\*END OF REPORT \*\*\*\*\*

## ANNEX A: Product Change Description

---

Quectel Wireless Solutions Co., Ltd.

---

# Statement

We, Quectel Wireless Solutions Co., Ltd, declare the following models as series application.

**Name:** LTE Module

**Parent Model:** EC25-AFX

**Variant Model:** EC25-AFXD, EC25-AFXD MINIPCIE

EC25-AFX, EC25-AFXD and EC25-AFXD MINIPCIE are all LTE modules. They use the same chipset, support same bands and share the same software & hardware design. The only difference is EC25-AFXD and EC25-AFXD MINIPCIE are data only modules which is configured by firmware based on EC25-AFX.

Following details are the difference of these modules.

Module	Frequency bands	Capability
EC25-AFX EC25-AFX MINIPCIE	FDD: B2/B4/B5/B12/B13/B14/B66/B71 WCDMA: B2/B4/B5	Cat.4 Data&Voice
EC25-AFXD EC25-AFXD MINIPCIE	FDD: B2/B4/B5/B12/B13/B14/B66/B71 WCDMA: B2/B4/B5	Cat.4 Data Only

Meanwhile, EC25-AFXD MINIPCIE makes up of EC25-AFXD module and PCIe carrier board. The carrier board switches EC25-AFXD module to follow PCI Express Mini Card 1.2 standard connector protocol. No any other internal changes in EC25-AFXD module. We hereby state that two models are identical in interior structure and components, and just connector interface is different for the marketing requirement.

Your assistance on this matter is highly appreciated.

Sincerely,

Name: Jean Hu 

Title: Certification Section