

FCC TEST REPORT

Client Name : Anker Innovations Limited
Address : Room 1318-19, Hollywood Plaza, 610 Nathan Road,
Mongkok, Kowloon, Hongkong
Product Name : Outdoor Cam Pro
Date : May 17, 2021



Shenzhen Anbotek Compliance Laboratory Limited

Contents

- 1. General Information.....5
 - 1.1. Client Information.....5
 - 1.2. Description of Device (EUT).....5
 - 1.3. Auxiliary Equipment Used During Test.....6
 - 1.4. Description of Test Modes.....6
 - 1.5. List of channels.....7
 - 1.6. Description Of Test Setup.....8
 - 1.7. Test Equipment List.....9
 - 1.8. Measurement Uncertainty.....10
 - 1.9. Description of Test Facility.....10
- 2. Summary of Test Results.....11
- 3. Conducted Emission Test.....12
 - 3.1. Test Standard and Limit.....12
 - 3.2. Test Setup.....12
 - 3.3. Test Procedure.....12
 - 3.4. Test Data.....12
- 4. Radiation Spurious Emission and Band Edge.....17
 - 4.1. Test Standard and Limit.....17
 - 4.2. Test Setup.....17
 - 4.3. Test Procedure.....18
 - 4.4. Test Data.....19
- 5. Maximum Peak Output Power Test.....28
 - 5.1. Test Standard and Limit.....28
 - 5.2. Test Setup.....28
 - 5.3. Test Procedure.....28
 - 5.4. Test Data.....28
- 6. 6DB Occupy Bandwidth Test.....32
 - 6.1. Test Standard and Limit.....32
 - 6.2. Test Setup.....32
 - 6.3. Test Procedure.....32
 - 6.4. Test Data.....32
- 7. Power Spectral Density Test.....39
 - 7.1. Test Standard and Limit.....39
 - 7.2. Test Setup.....39
 - 7.3. Test Procedure.....39
 - 7.4. Test Data.....39
- 8. 100kHz Bandwidth of Frequency Band Edge Requirement.....45
 - 8.1. Test Standard and Limit.....45

8.2. Test Setup.....45

8.3. Test Procedure.....45

8.4. Test Data.....45

9. Antenna Requirement.....54

9.1. Test Standard and Requirement.....54

9.2. Antenna Connected Construction.....54

APPENDIX I -- TEST SETUP PHOTOGRAPH.....55

APPENDIX II -- EXTERNAL PHOTOGRAPH.....55

APPENDIX III -- INTERNAL PHOTOGRAPH.....55

TEST REPORT

Applicant : Anker Innovations Limited
Manufacturer : Anker Innovations Limited
Product Name : Outdoor Cam Pro
Model No. : T8441X
Trade Mark : eufy SECURITY
Rating(s) : Input: DC 5V, 1A(via adapter input: 100-240V~50/60Hz, 0.2A Max)
Test Standard(s) : FCC Part15 Subpart C, Section 15.247
Test Method(s) : ANSI C63.10: 2013, KDB558074 D01 DTS Meas Guidance v05r02

The device described above is tested by Shenzhen Anbotek Compliance Laboratory Limited to determine the maximum emission levels emanating from the device and the severe levels of the device can endure and its performance criterion. The measurement results are contained in this test report and Shenzhen Anbotek Compliance Laboratory Limited is assumed full of responsibility for the accuracy and completeness of these measurements. Also, this report shows that the EUT (Equipment Under Test) is technically compliant with the FCC Part 15 Subpart C requirements.

This report applies to above tested sample only and shall not be reproduced in part without written approval of Shenzhen Anbotek Compliance Laboratory Limited.

Date of Receipt

Apr. 19, 2021

Date of Test

Apr. 19~May 13, 2021

Prepared by



(Ella Liang)

Approved & Authorized Signer



(Kingkong Jin)

1. General Information

1.1. Client Information

Applicant	:	Anker Innovations Limited
Address	:	Room 1318-19, Hollywood Plaza, 610 Nathan Road, Mongkok, Kowloon, Hongkong
Manufacturer	:	Anker Innovations Limited
Address	:	Room 1318-19, Hollywood Plaza, 610 Nathan Road, Mongkok, Kowloon, Hongkong

1.2. Description of Device (EUT)

Product Name	:	Outdoor Cam Pro
Model No.	:	T8441X
Trade Mark	:	eufy SECURITY
Test Power Supply	:	AC 240V, 60Hz for adapter/ AC 120V, 60Hz for adapter
Test Sample No.	:	1-2-1(Normal Sample), 1-2-2(Engineering Sample)
Product Description	Operation Frequency:	BLE: 2402~2480MHz WiFi 2.4G: 2412-2462MHz for 802.11b/g/n(HT20)
	Number of Channel:	BLE: 40 Channels 2.4G 802.11b/ g/ n(HT20): 11 Channels
	Modulation Type:	BLE: GFSK WiFi 2.4G: CCK, DQPSK, DBPSK for DSSS 64QAM, 16QAM, QPSK, BPSK for OFDM
	Antenna Type:	BLE&WiFi 2.4G: Metal antenna
	Antenna Gain(Peak):	BLE: 2.9 dBi WiFi 2.4G: 2.9 dBi
<p>Remark: 1)For a more detailed features description, please refer to the manufacturer’s specifications or the User’s Manual. 2) This report is for WIFI 2.4G module.</p>		

1.3. Auxiliary Equipment Used During Test

N/A	
-----	--

1.4. Description of Test Modes

To investigate the maximum EMI emission characteristics generates from EUT, the test system was pre-scanning tested base on the consideration of following EUT operation mode or test configuration mode which possible have effect on EMI emission level. Each of these EUT operation mode(s) or test configuration mode(s) mentioned above was evaluated respectively.

RADIATED EMISSION TEST (BELOW 1GHz):

Pre-Scan has been conducted to determine the worst-case mode from all possible combinations between available modulations, data rates, XYZ axis and antenna ports (if EUT with antenna diversity architecture).

Following channel(s) was (were) selected for the final test as listed below.

Mode	Available Channel	Test Channel	Modulation Tech.	Data Rate (Mbps)
802.11b	1 to 11	1, 6, 11	DSSS	1.0

For the test results, only the worst case was shown in test report.

RADIATED EMISSION TEST (ABOVE 1GHz):

Pre-Scan has been conducted to determine the worst-case mode from all possible combinations between available modulations, data rates, XYZ axis and antenna ports (if EUT with antenna diversity architecture).

Following channel(s) was (were) selected for the final test as listed below.

Mode	Available Channel	Test Channel	Modulation Tech.	Data Rate (Mbps)
802.11b	1 to 11	1, 6, 11	DSSS	1.0
802.11g	1 to 11	1, 6, 11	OFDM	6.0
802.11n HT20	1 to 11	1, 6, 11	OFDM	6.5

POWER LINE CONDUCTED EMISSION TEST:

The EUT was tested with the following mode

Mode	Available Channel	Test Channel	Modulation Tech.	Data Rate (Mbps)
802.11b	1 to 11	1, 6, 11	DSSS	1.0
802.11g	1 to 11	1, 6, 11	OFDM	6.0
802.11n HT20	1 to 11	1, 6, 11	OFDM	6.5

BANDEDGE MEASUREMENT:

Pre-Scan has been conducted to determine the worst-case mode from all possible combinations between available modulations, data rates and antenna ports (if EUT with antenna diversity architecture).

Following channel(s) was (were) selected for the final test as listed below.

Mode	Available Channel	Test Channel	Modulation Tech.	Data Rate (Mbps)
802.11b	1 to 11	1, 11	DSSS	1.0
802.11g	1 to 11	1, 11	OFDM	6.0
802.11n HT20	1 to 11	1, 11	OFDM	6.5

ANTENNA PORT CONDUCTED MEASUREMENT:

This item includes all test value of each mode, but only includes spectrum plot of worst value of each mode.

Pre-Scan has been conducted to determine the worst-case mode from all possible combinations between available modulations, data rates and antenna ports (if EUT with antenna diversity architecture).

Following channel(s) was (were) selected for the final test as listed below.

Mode	Available Channel	Test Channel	Modulation Tech.	Data Rate (Mbps)
802.11b	1 to 11	1, 6, 11	DSSS	1.0
802.11g	1 to 11	1, 6, 11	OFDM	6.0
802.11n HT20	1 to 11	1, 6, 11	OFDM	6.5

1.5. List of channels

Channel	Freq. (MHz)	Channel	Freq. (MHz)	Channel	Freq. (MHz)	Channel	Freq. (MHz)
01	2412	04	2427	07	2442	10	2457
02	2417	05	2432	08	2447	11	2462
03	2422	06	2437	09	2452		

1.6. Description Of Test Setup

CE

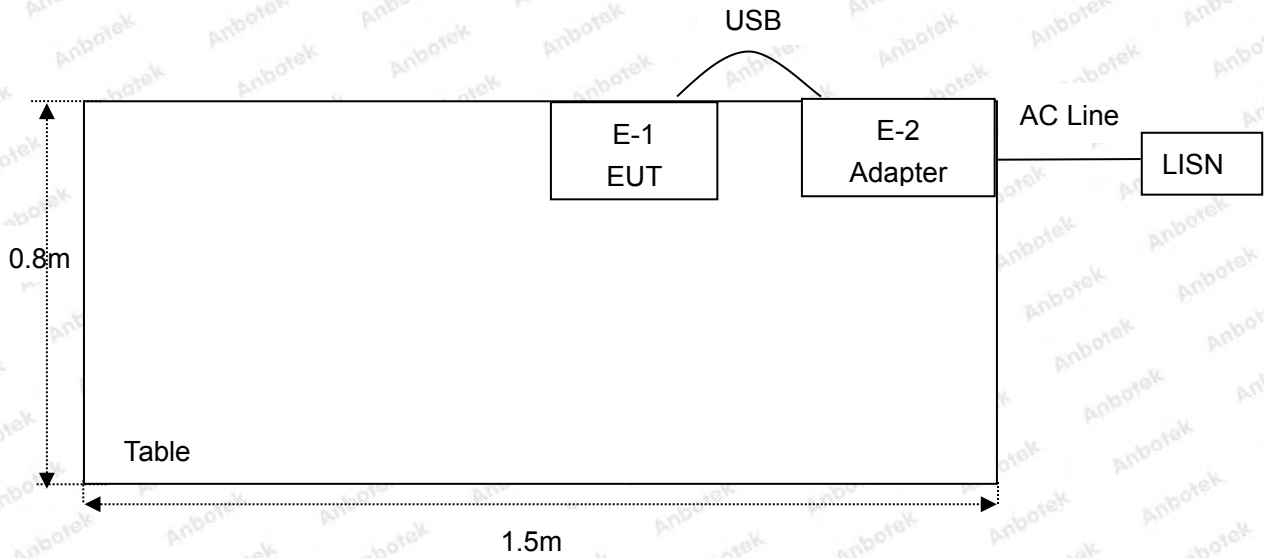

RE

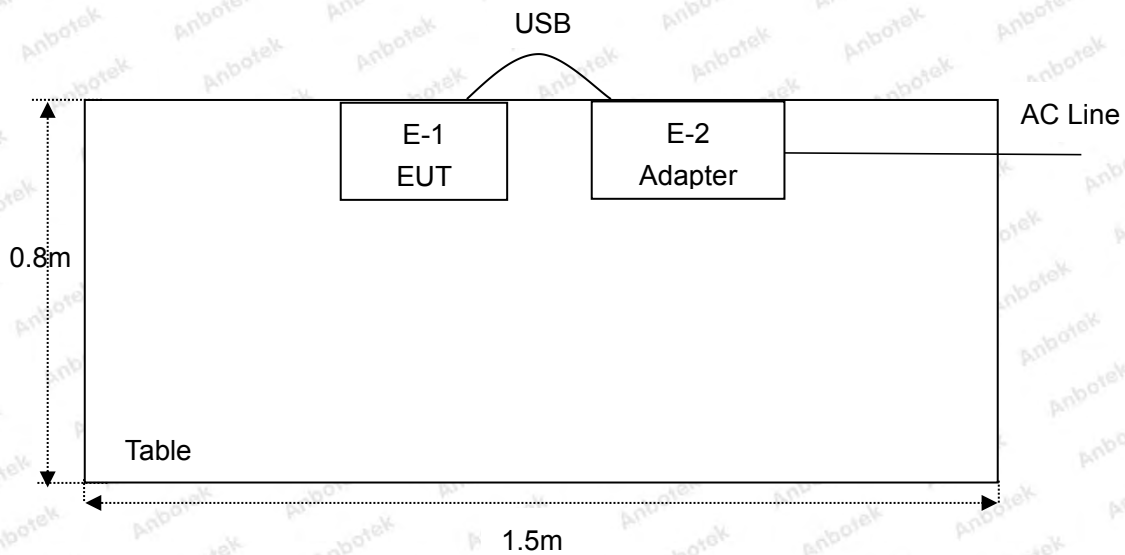

1.7. Test Equipment List

Item	Equipment	Manufacturer	Model No.	Serial No.	Last Cal.	Cal. Interval
1.	L.I.S.N. Artificial Mains Network	Rohde & Schwarz	ENV216	100055	Oct. 26, 2020	1 Year
2.	EMI Test Receiver	Rohde & Schwarz	ESCI	100627	Oct. 26, 2020	1 Year
3.	EMI Test Receiver	Rohde & Schwarz	ESR26	101481	Oct. 26, 2020	1 Year
4.	RF Switching Unit	Compliance Direction	RSU-M2	38303	Oct. 26, 2020	1 Year
5.	MAX Spectrum Analysis	Agilent	N9020A	MY51170037	Oct. 26, 2020	1 Year
6.	Preamplifier	SKET Electronic	BK1G18G30 D	KD17503	Oct. 26, 2020	1 Year
7.	Double Ridged Horn Antenna	Instruments corporation	GTH-0118	351600	Nov. 02, 2020	2 Year
8.	Bilog Broadband Antenna	Schwarzbeck	VULB9163	VULB 9163-289	Nov. 02, 2020	2 Year
9.	Loop Antenna	Schwarzbeck	FMZB1519B	00053	Nov. 02, 2020	2 Year
10.	Horn Antenna	A-INFO	LB-180400- KF	J211060628	Nov. 02, 2020	2 Year
11.	Pre-amplifier	SONOMA	310N	186860	Oct. 26, 2020	1 Year
12.	EMI Test Software EZ-EMC	SHURPLE	N/A	N/A	N/A	N/A
13.	RF Test Control System	YIHENG	YH3000	2017430	Oct. 26, 2020	1 Year
14.	Power Sensor	DAER	RPR3006W	15I00041SN045	Oct. 26, 2020	1 Year
15.	Power Sensor	DAER	RPR3006W	15I00041SN046	Oct. 26, 2020	1 Year
16.	MXA Spectrum Analysis	Agilent	N9020A	MY51170037	Oct. 26, 2020	1 Year
17.	MXG RF Vector Signal Generator	Agilent	N5182A	MY48180656	Oct. 26, 2020	1 Year
18.	Signal Generator	Agilent	E4421B	MY41000743	Oct. 26, 2020	1 Year
19.	DC Power Supply	IVYTECH	IV3605	1804D360510	Oct. 26, 2020	1 Year
20.	Constant Temperature Humidity Chamber	ZHONGJIAN	ZJ-KHWS80 B	N/A	Oct. 26, 2020	1 Year

1.8. Measurement Uncertainty

Radiation Uncertainty	:	Ur = 3.9 dB (Horizontal)
		Ur = 3.8 dB (Vertical)
Conduction Uncertainty	:	Uc = 3.4 dB

1.9. Description of Test Facility

The test facility is recognized, certified, or accredited by the following organizations:

FCC-Registration No.: 184111

Shenzhen Anbotek Compliance Laboratory Limited, EMC Laboratory has been registered and fully described in a report filed with the (FCC) Federal Communications Commission. The acceptance letter from the FCC is maintained in our files. Registration No. 184111, September 30, 2020.

ISED-Registration No.: 8058A

Shenzhen Anbotek Compliance Laboratory Limited, EMC Laboratory has been registered and fully described in a report filed with the (ISED) Innovation, Science and Economic Development Canada. The acceptance letter from the ISED is maintained in our files. Registration 8058A, September 30, 2020.

Test Location

Shenzhen Anbotek Compliance Laboratory Limited.

1/F, Building D, Sogood Science and Technology Park, Sanwei community, Hangcheng Street, Bao'an District, Shenzhen, Guangdong, China.518102

2. Summary of Test Results

Standard Section	Test Item	Result
15.203/15.247(c)	Antenna Requirement	PASS
15.207	Conducted Emission	PASS
15.205/15.209	Spurious Emission	PASS
15.247(b)(3)	Conducted Peak Output Power	PASS
15.247(a)(2)	6dB Occupied Bandwidth	PASS
15.247(e)	Power Spectral Density	PASS
15.247(d)	Band Edge	PASS
<p>Remark: "N/A" is an abbreviation for Not Applicable.</p>		

3. Conducted Emission Test

3.1. Test Standard and Limit

Test Standard	FCC Part15 Section 15.207		
Test Limit	Frequency	Maximum RF Line Voltage (dBuV)	
		Quasi-peak Level	Average Level
	150kHz~500kHz	66 ~ 56 *	56 ~ 46 *
	500kHz~5MHz	56	46
5MHz~30MHz	60	50	

Remark: (1) *Decreasing linearly with logarithm of the frequency.
 (2) The lower limit shall apply at the transition frequency.

3.2. Test Setup

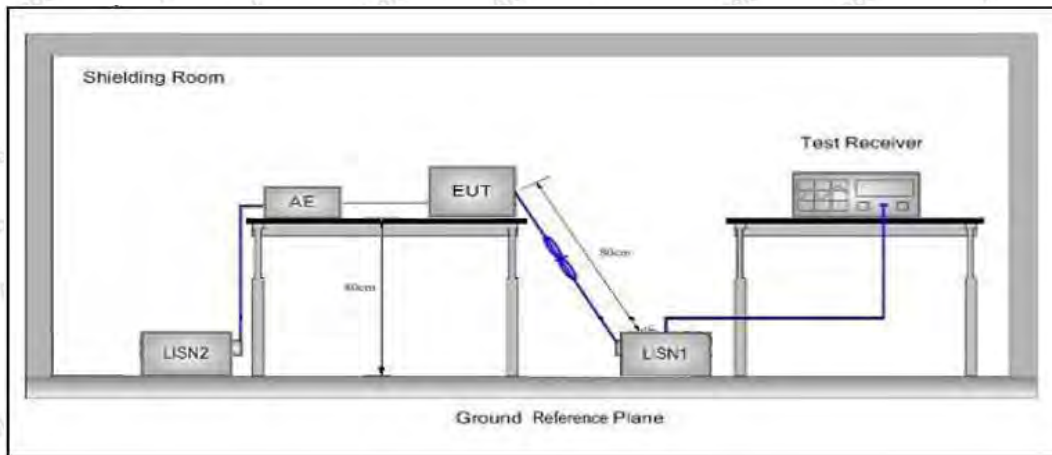

3.3. Test Procedure

The EUT system is connected to the power mains through a line impedance stabilization network (L.I.S.N.). This provides a 50ohm coupling impedance for the EUT system. Please refer the block diagram of the test setup and photographs. Both sides of AC line are checked to find out the maximum conducted emission. In order to find the maximum emission levels, the relative positions of equipment and all of the interface cables shall be changed according to FCC ANSI C63.10-2013 on Conducted Emission Measurement.

The bandwidth of test receiver (ESCI) set at 9kHz.

The frequency range from 150kHz to 30MHz is checked.

3.4. Test Data

During the test, pre-scan all modes, and found the 802.11b CH 06 which is the worst case, only the worst case is recorded in the report..

Conducted Emission Test Data

Test Site: 1# Shielded Room
 Operating Condition: 802.11b CH 06
 Test Specification: AC 240V, 60Hz for adapter
 Comment: Live Line
 Tem.: 23.4°C Hum.: 46%

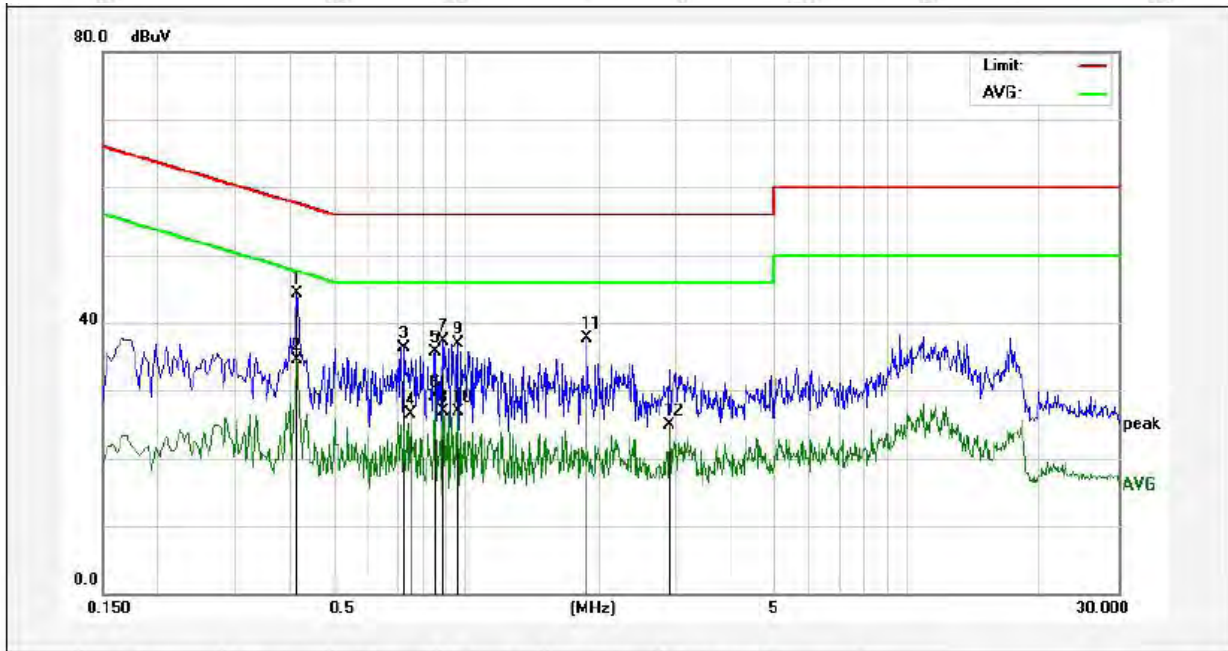

No.	Freq. (MHz)	Reading (dBuV)	Factor (dB)	Result (dBuV)	Limit (dBuV)	Over Limit (dB)	Detector	Remark
1	0.4140	24.32	19.94	44.26	57.57	-13.31	QP	
2	0.4140	14.65	19.94	34.59	47.57	-12.98	AVG	
3	0.7260	16.33	20.05	36.38	56.00	-19.62	QP	
4	0.7500	6.52	20.05	26.57	46.00	-19.43	AVG	
5	0.8500	15.70	20.08	35.78	56.00	-20.22	QP	
6	0.8500	8.96	20.08	29.04	46.00	-16.96	AVG	
7	0.8860	17.13	20.09	37.22	56.00	-18.78	QP	
8	0.8860	6.80	20.09	26.89	46.00	-19.11	AVG	
9	0.9620	16.81	20.11	36.92	56.00	-19.08	QP	
10	0.9620	6.83	20.11	26.94	46.00	-19.06	AVG	
11	1.8860	17.66	20.14	37.80	56.00	-18.20	QP	
12	2.8860	4.69	20.16	24.85	46.00	-21.15	AVG	

Conducted Emission Test Data

Test Site: 1# Shielded Room
 Operating Condition: 802.11b CH 06
 Test Specification: AC 240V, 60Hz for adapter
 Comment: Neutral Line
 Tem.: 23.4°C Hum.: 46%

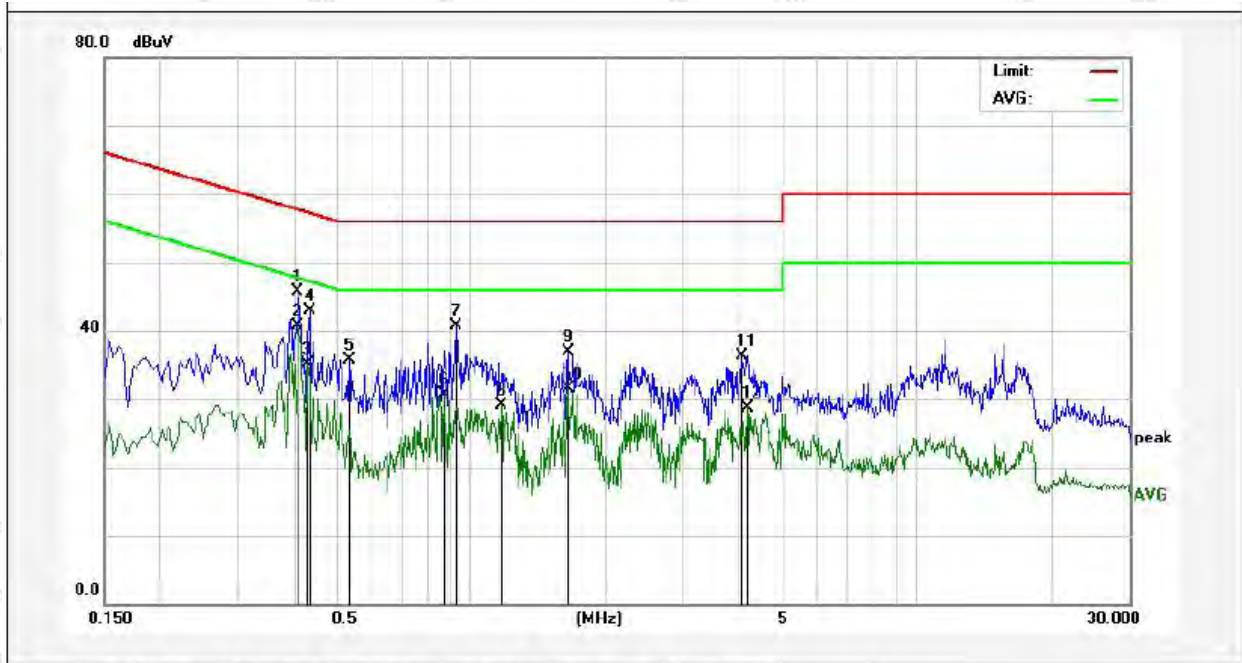

No.	Freq. (MHz)	Reading (dBuV)	Factor (dB)	Result (dBuV)	Limit (dBuV)	Over Limit (dB)	Detector	Remark
1	0.4100	25.67	19.94	45.61	57.65	-12.04	QP	
2	0.4100	20.68	19.94	40.62	47.65	-7.03	AVG	
3	0.4300	15.11	19.95	35.06	47.25	-12.19	AVG	
4	0.4340	23.02	19.95	42.97	57.18	-14.21	QP	
5	0.5340	15.73	19.99	35.72	56.00	-20.28	QP	
6	0.8700	10.64	20.09	30.73	46.00	-15.27	AVG	
7	0.9260	20.68	20.10	40.78	56.00	-15.22	QP	
8	1.1700	8.97	20.12	29.09	46.00	-16.91	AVG	
9	1.6500	16.86	20.13	36.99	56.00	-19.01	QP	
10	1.6500	11.39	20.13	31.52	46.00	-14.48	AVG	
11	4.0540	16.22	20.18	36.40	56.00	-19.60	QP	
12	4.1620	8.62	20.18	28.80	46.00	-17.20	AVG	

Conducted Emission Test Data

Test Site: 1# Shielded Room
 Operating Condition: 802.11b CH 06
 Test Specification: AC 120V, 60Hz for adapter
 Comment: Live Line
 Tem.: 23.4°C Hum.: 46%

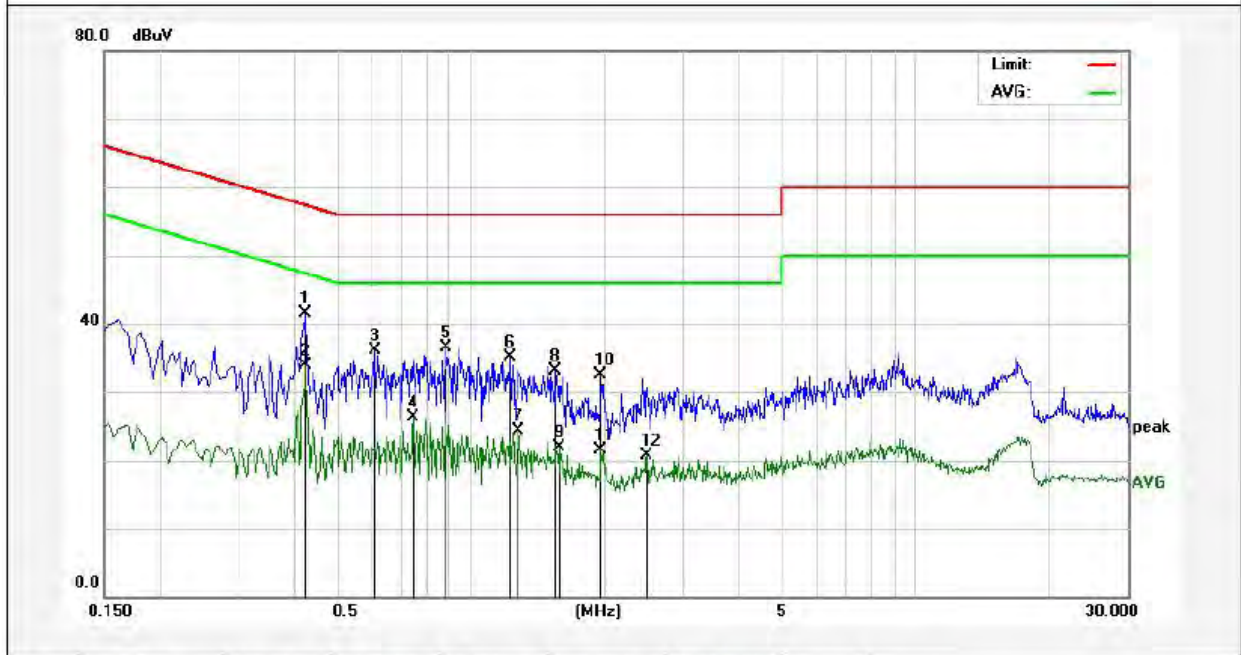

No.	Freq. (MHz)	Reading (dBuV)	Factor (dB)	Result (dBuV)	Limit (dBuV)	Over Limit (dB)	Detector	Remark
1	0.4260	21.54	19.95	41.49	57.33	-15.84	QP	
2	0.4260	13.95	19.95	33.90	47.33	-13.43	AVG	
3	0.6100	16.08	20.01	36.09	56.00	-19.91	QP	
4	0.7460	6.21	20.05	26.26	46.00	-19.74	AVG	
5	0.8820	16.36	20.09	36.45	56.00	-19.55	QP	
6	1.2340	14.90	20.12	35.02	56.00	-20.98	QP	
7	1.2860	4.18	20.13	24.31	46.00	-21.69	AVG	
8	1.5580	12.98	20.13	33.11	56.00	-22.89	QP	
9	1.5900	1.86	20.13	21.99	46.00	-24.01	AVG	
10	1.9620	12.28	20.14	32.42	56.00	-23.58	QP	
11	1.9620	1.38	20.14	21.52	46.00	-24.48	AVG	
12	2.4940	0.49	20.15	20.64	46.00	-25.36	AVG	

Conducted Emission Test Data

Test Site: 1# Shielded Room
 Operating Condition: 802.11b CH 06
 Test Specification: AC 120V, 60Hz for adapter
 Comment: Neutral Line
 Tem.: 23.4°C Hum.: 46%

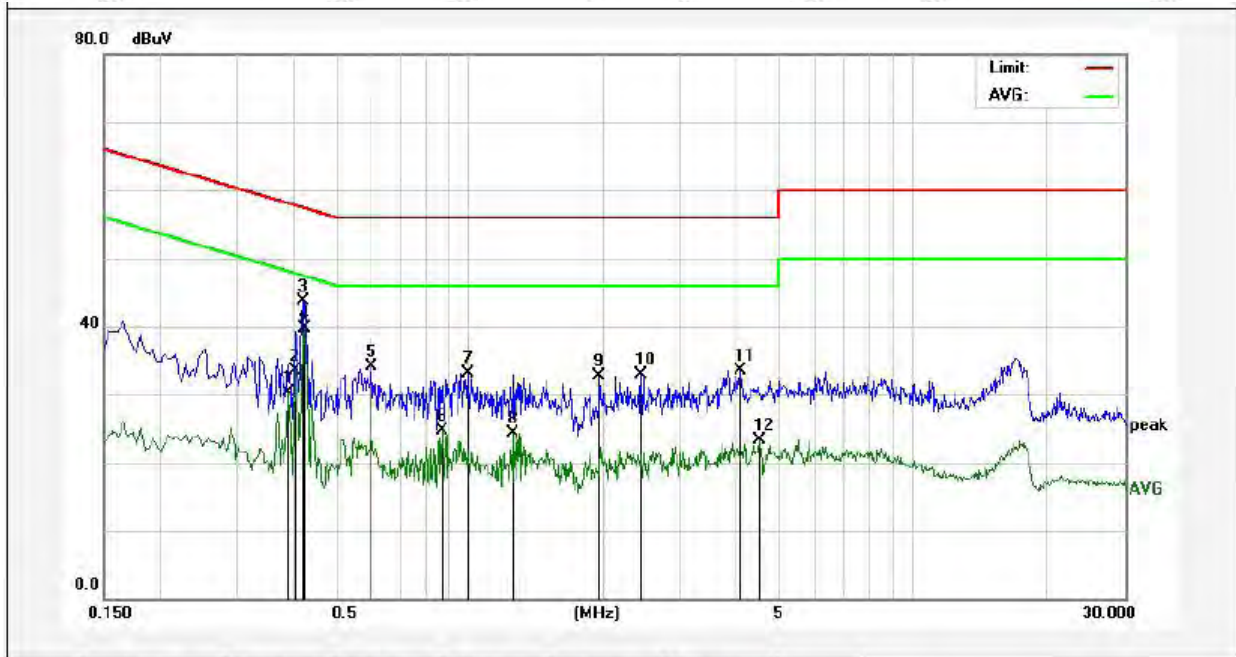

No.	Freq. (MHz)	Reading (dBuV)	Factor (dB)	Result (dBuV)	Limit (dBuV)	Over Limit (dB)	Detector	Remark
1	0.3899	10.34	19.93	30.27	48.06	-17.79	AVG	
2	0.4060	13.66	19.94	33.60	47.73	-14.13	AVG	
3	0.4220	23.81	19.94	43.75	57.41	-13.66	QP	
4	0.4260	19.82	19.95	39.77	47.33	-7.56	AVG	
5	0.6020	14.17	20.01	34.18	56.00	-21.82	QP	
6	0.8700	4.69	20.09	24.78	46.00	-21.22	AVG	
7	0.9940	13.03	20.12	33.15	56.00	-22.85	QP	
8	1.2620	4.27	20.13	24.40	46.00	-21.60	AVG	
9	1.9660	12.63	20.14	32.77	56.00	-23.23	QP	
10	2.4460	12.76	20.15	32.91	56.00	-23.09	QP	
11	4.0899	13.39	20.18	33.57	56.00	-22.43	QP	
12	4.5219	3.02	20.19	23.21	46.00	-22.79	AVG	

4. Radiation Spurious Emission and Band Edge

4.1. Test Standard and Limit

Test Standard	FCC Part15 C Section 15.209 and 15.205				
Test Limit	Frequency (MHz)	Field strength (microvolt/meter)	Limit (dBuV/m)	Remark	Measurement distance (m)
	0.009MHz~0.490MHz	2400/F(kHz)	-	-	300
	0.490MHz-1.705MHz	24000/F(kHz)	-	-	30
	1.705MHz-30MHz	30	-	-	30
	30MHz~88MHz	100	40.0	Quasi-peak	3
	88MHz~216MHz	150	43.5	Quasi-peak	3
	216MHz~960MHz	200	46.0	Quasi-peak	3
	960MHz~1000MHz	500	54.0	Quasi-peak	3
	Above 1000MHz	500	54.0	Average	3
-		74.0	Peak	3	

Remark:

(1)The lower limit shall apply at the transition frequency.

(2) 15.35(b), Unless otherwise specified, the limit on peak radio frequency emissions is 20dB above the maximum permitted average emission limit applicable to the equipment under test. This peak limit applies to the total peak emission level radiated by the device.

4.2. Test Setup

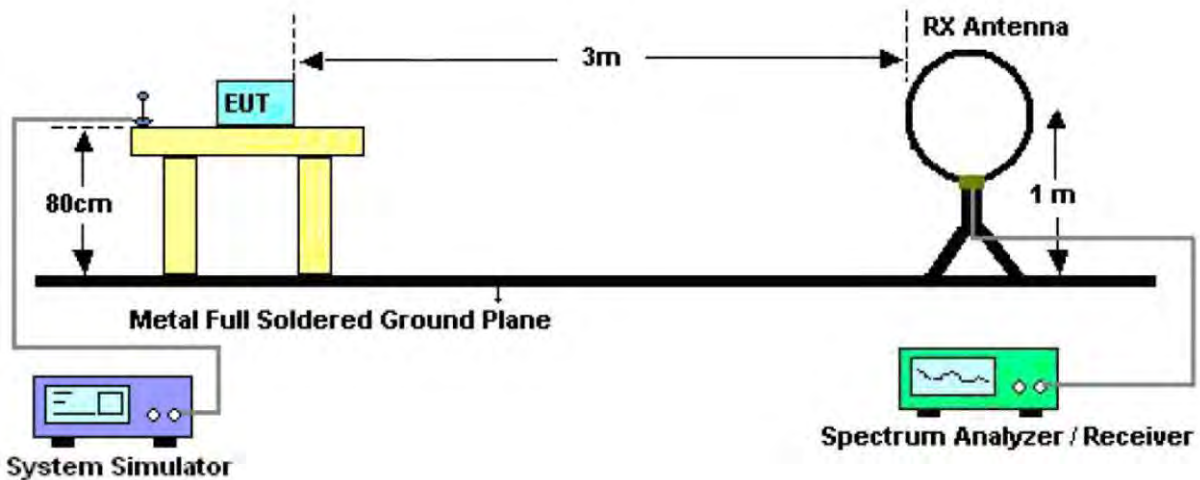

Figure 1. Below 30MHz

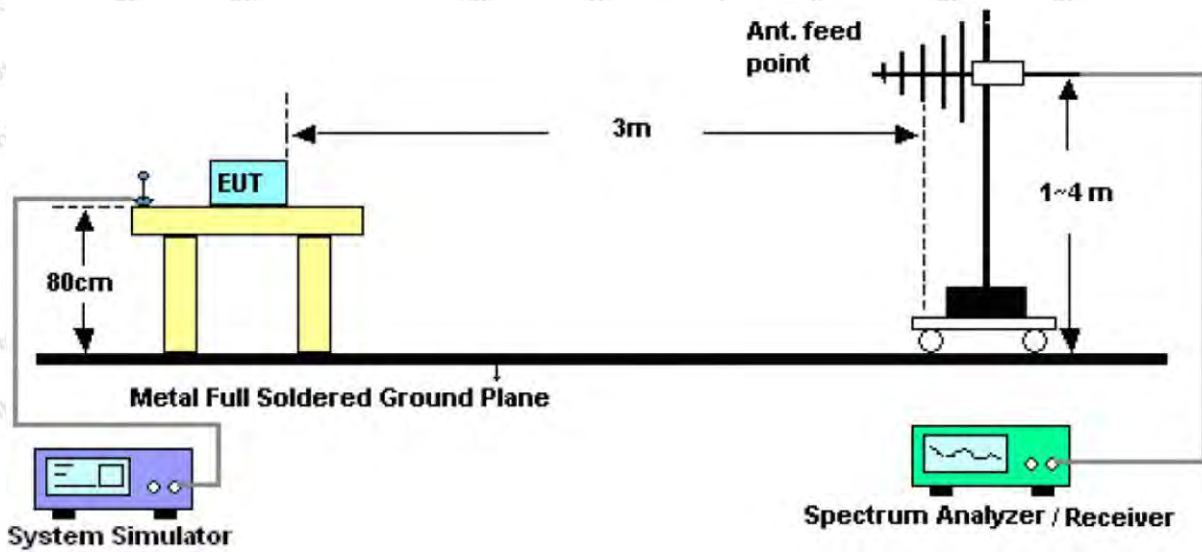

Figure 2. 30MHz to 1GHz

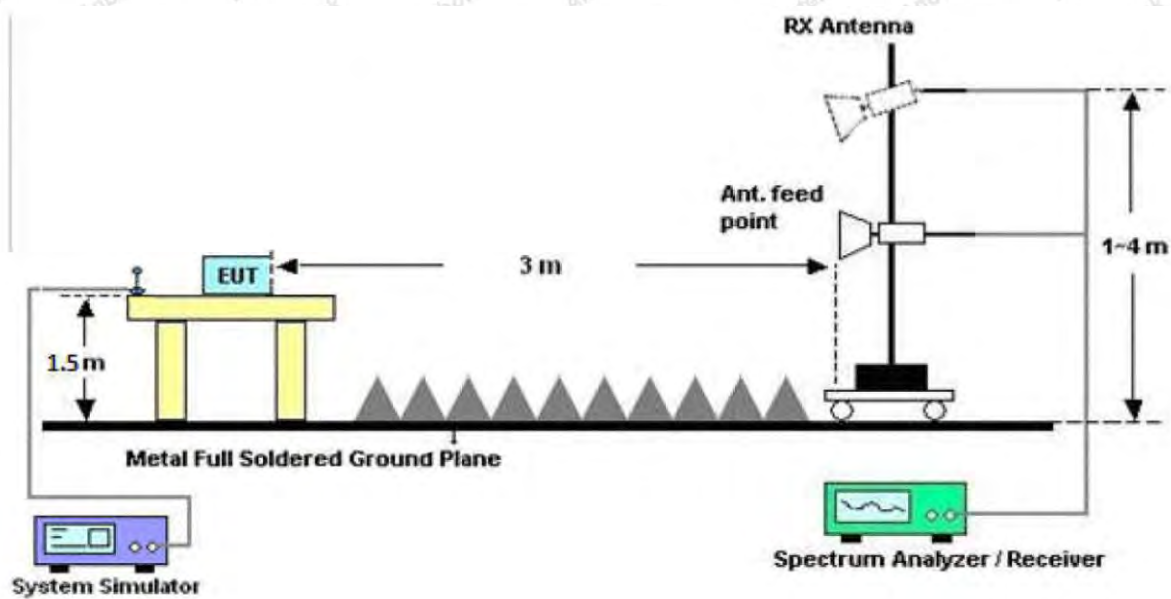

Figure 3. Above 1 GHz

4.3. Test Procedure

For below 1GHz: The EUT is placed on a turntable, which is 0.8m above the ground plane.

For above 1GHz: The EUT is placed on a turntable, which is 1.5m above the ground plane.

The turn table can rotate 360 degrees to determine the position of the maximum emission level. The EUT is set 3 meters away from the receiving antenna which is mounted on a antenna tower. The antenna can be moved up and down from 1 to 4 meters to find out the maximum emission level. Rotated the EUT through three orthogonal axes to determine the maximum emissions, both horizontal and vertical polarization of the antenna are set on test. The EUT is tested in 9*6*6 Chamber. The device is evaluated in xyz orientation.

For the radiated emission test above 1GHz:

Place the measurement antenna away from each area of the EUT determined to be a source of emissions at the specified measurement distance, while keeping the measurement antenna aimed at the source of emissions at each frequency of significant emissions, with polarization oriented for maximum response. The measurement antenna may have to be higher or lower than the EUT, depending on the radiation pattern of the emission and staying aimed at the emission source for receiving the maximum signal. The final measurement antenna elevation shall be that which maximizes the emissions. The measurement antenna elevation for maximum emissions shall be restricted to a range of heights of from 1 m to 4 m above the ground or reference ground plane.

For 9kHz to 150kHz, Set the spectrum analyzer as:

RBW = 200Hz, VBW =1kHz, Detector= Quasi-Peak, Trace mode= Max hold, Sweep- auto couple.

For 150kHz to 30MHz, Set the spectrum analyzer as:

RBW = 9KHz, VBW =30kHz, Detector= Quasi-Peak, Trace mode= Max hold, Sweep- auto couple.

For 30MHz to 1000MHz, Set the spectrum analyzer as:

RBW = 100kHz, VBW =300kHz, Detector= Quasi-Peak, Trace mode= Max hold, Sweep- auto couple.

For above 1GHz,Set the spectrum analyzer as:

RBW =1MHz, VBW =1MHz, Detector= Peak, Trace mode= Max hold, Sweep- auto couple.

RBW =1MHz, VBW =10Hz, Detector= Average, Trace mode= Max hold, Sweep- auto couple.

4.4. Test Data

PASS

During the test, Pre-scan all kind of the place mode (X-axis, Y-axis, Z-axis), and found the X-axis is the worst case.

The test results of 9kHz-30MHz was attenuated more than 20dB below the permissible limits, so the results don't record in the report.

During the test, pre-scan all modes, and found the 802.11b CH 06 which is the worst case, only the worst case is recorded in the report.



Test Results (30~1000MHz)

Test Mode: 802.11b CH 06
 Power Source: AC 120V, 60Hz for adapter
 Polarization: Horizontal
 Temp.(°C)/Hum.(%RH): 24.4°C/47%RH

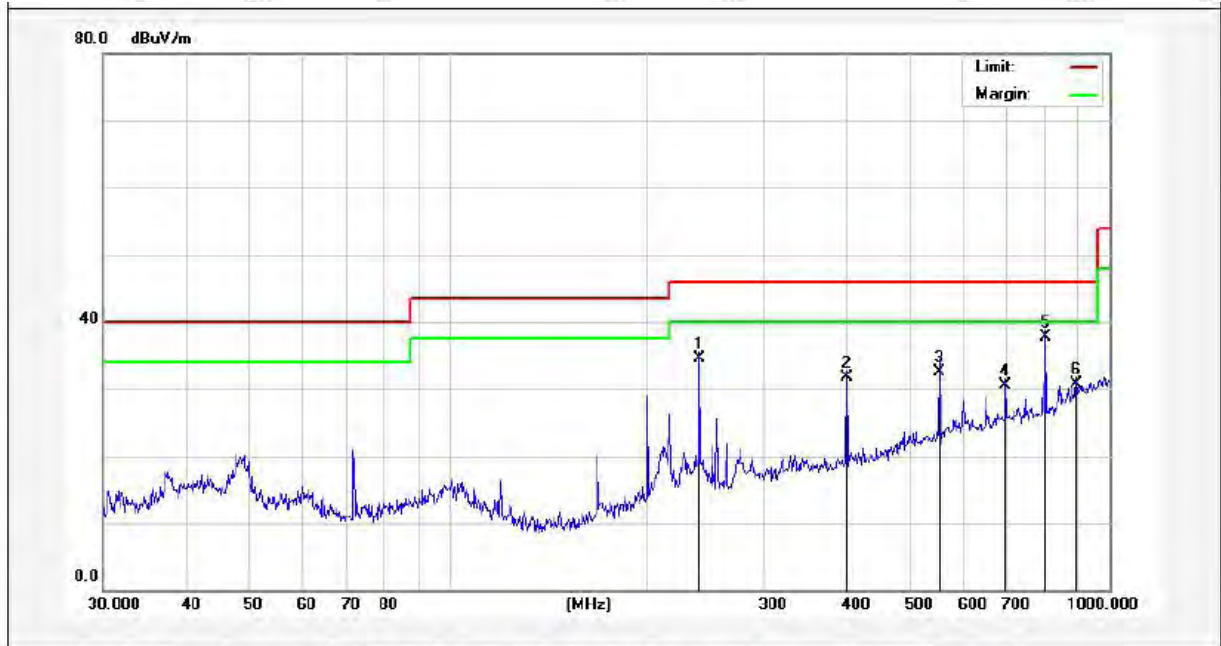

No.	Freq. (MHz)	Reading (dBuV)	Factor (dB/m)	Result (dBuV/m)	Limit (dBuV/m)	Over Limit (dB)	Detector	Height (cm)	degree (deg)	Remark
1	239.9874	53.53	-19.04	34.49	46.00	-11.51	QP	100	0	
2	400.4319	44.78	-12.98	31.80	46.00	-14.20	QP	100	360	
3	552.8832	40.55	-7.96	32.59	46.00	-13.41	QP	100	0	
4	696.8567	36.56	-6.05	30.51	46.00	-15.49	QP	100	360	
5	801.7863	41.79	-4.13	37.66	46.00	-8.34	QP	100	0	
6	890.7278	32.72	-1.98	30.74	46.00	-15.26	QP	100	360	

Test Results (30~1000MHz)

Test Mode: 802.11b CH 06
 Power Source: AC 120V, 60Hz for adapter
 Polarization: Vertical
 Temp.(°C)/Hum.(%RH): 24.4°C/47%RH

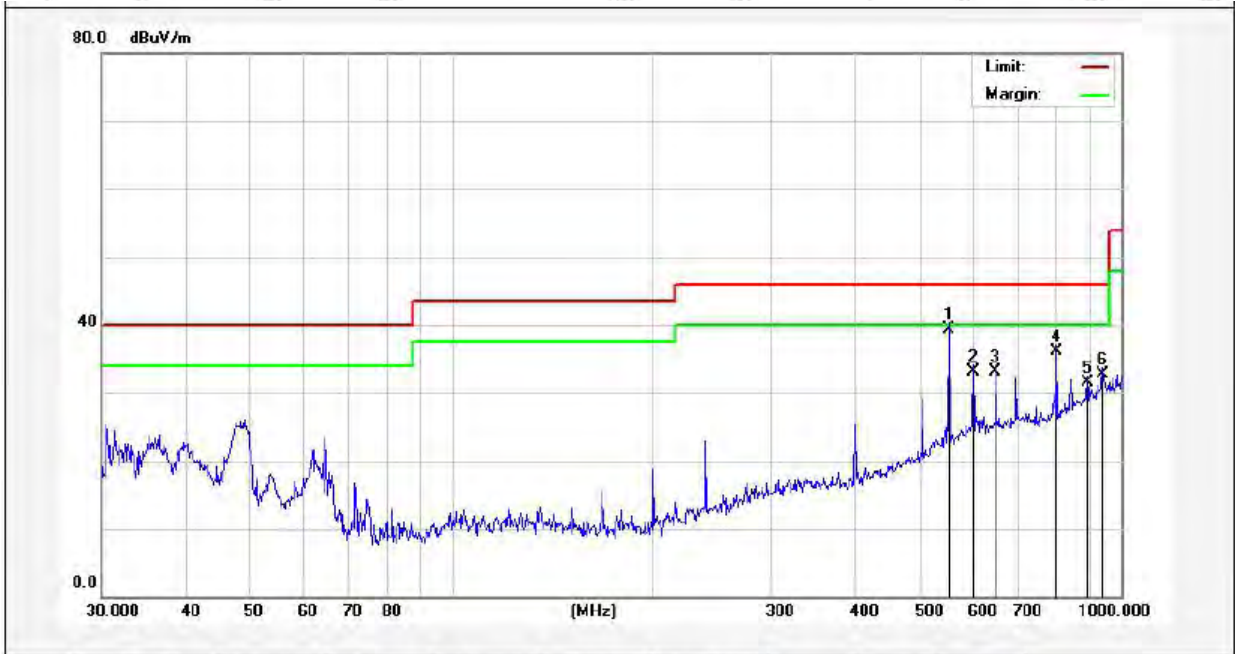

No.	Freq. (MHz)	Reading (dBuV)	Factor (dB/m)	Result (dBuV/m)	Limit (dBuV/m)	Over Limit (dB)	Detector	Height (cm)	degree (deg)	Remark
1	552.8832	47.30	-7.96	39.34	46.00	-6.66	QP	100	0	
2	601.4265	39.85	-6.75	33.10	46.00	-12.90	QP	100	360	
3	649.6597	39.97	-6.82	33.15	46.00	-12.85	QP	100	0	
4	801.7863	40.33	-4.13	36.20	46.00	-9.80	QP	100	360	
5	890.7278	33.42	-1.98	31.44	46.00	-14.56	QP	100	0	
6	938.8326	33.80	-1.03	32.77	46.00	-13.23	QP	100	360	

Test Results (Above 1000MHz)

Test Mode: 802.11b Mode				Test channel: Lowest		
Peak Value						
Frequency (MHz)	Read Level (dBuV)	Factor (dB/m)	Level (dBuV/m)	Limit (dBuV/m)	Over Limit (dB)	Pol.
4824.00	37.52	15.31	52.83	74.00	-21.17	V
7236.00	32.46	18.06	50.52	74.00	-23.48	V
9648.00	31.46	23.77	55.23	74.00	-18.77	V
12060.00	*			74.00		V
14472.00	*			74.00		V
16884.00	*			74.00		V
4824.00	36.62	15.31	51.93	74.00	-22.07	H
7236.00	32.43	18.06	50.49	74.00	-23.51	H
9648.00	31.13	23.77	54.90	74.00	-19.10	H
12060.00	*			74.00		H
14472.00	*			74.00		H
16884.00	*			74.00		H
Average Value						
Frequency (MHz)	Read Level (dBuV)	Factor (dB/m)	Level (dBuV/m)	Limit (dBuV/m)	Over Limit (dB)	Pol.
4824.00	26.82	15.31	42.13	54.00	-11.87	V
7236.00	21.39	18.06	39.45	54.00	-14.55	V
9648.00	21.86	23.77	45.63	54.00	-8.37	V
12060.00	*			54.00		V
14472.00	*			54.00		V
16884.00	*			54.00		V
4824.00	26.30	15.31	41.61	54.00	-12.39	H
7236.00	21.06	18.06	39.12	54.00	-14.88	H
9648.00	20.92	23.77	44.69	54.00	-9.31	H
12060.00	*			54.00		H
14472.00	*			54.00		H
16884.00	*			54.00		H

Test Results (Above 1000MHz)

Test Mode: 802.11b Mode				Test channel: Middle		
Peak Value						
Frequency (MHz)	Read Level (dBuV)	Factor (dB/m)	Level (dBuV/m)	Limit (dBuV/m)	Over Limit (dB)	Pol.
4874.00	37.05	15.41	52.46	74.00	-21.54	V
7311.00	32.84	18.01	50.85	74.00	-23.15	V
9748.00	32.69	23.09	55.78	74.00	-18.22	V
12185.00	*			74.00		V
14622.00	*			74.00		V
17059.00	*			74.00		V
4874.00	37.89	15.41	53.30	74.00	-20.70	H
7311.00	31.66	18.01	49.67	74.00	-24.33	H
9748.00	32.66	23.09	55.75	74.00	-18.25	H
12185.00	*			74.00		H
14622.00	*			74.00		H
17059.00	*			74.00		H
Average Value						
Frequency (MHz)	Read Level (dBuV)	Factor (dB/m)	Level (dBuV/m)	Limit (dBuV/m)	Over Limit (dB)	Pol.
4874.00	28.09	15.41	43.50	54.00	-10.50	V
7311.00	21.20	18.01	39.21	54.00	-14.79	V
9748.00	21.99	23.09	45.08	54.00	-8.92	V
12185.00	*			54.00		V
14622.00	*			54.00		V
17059.00	*			54.00		V
4874.00	28.12	15.41	43.53	54.00	-10.47	H
7311.00	20.79	18.01	38.80	54.00	-15.20	H
9748.00	22.41	23.09	45.50	54.00	-8.50	H
12185.00	*			54.00		H
14622.00	*			54.00		H
17059.00	*			54.00		H

Test Results (Above 1000MHz)

Test Mode: 802.11b Mode				Test channel: Highest		
Peak Value						
Frequency (MHz)	Read Level (dBuV)	Factor (dB/m)	Level (dBuV/m)	Limit (dBuV/m)	Over Limit (dB)	Pol.
4924.00	40.92	15.51	56.43	74.00	-17.57	V
7386.00	32.46	17.97	50.43	74.00	-23.57	V
9848.00	35.24	23.82	59.06	74.00	-14.94	V
12310.00	*			74.00		V
14772.00	*			74.00		V
17234.00	*			74.00		V
4924.00	40.84	15.51	56.35	74.00	-17.65	H
7386.00	31.68	17.97	49.65	74.00	-24.35	H
9848.00	31.55	23.82	55.37	74.00	-18.63	H
12310.00	*			74.00		H
14772.00	*			74.00		H
17234.00	*			74.00		H
Average Value						
Frequency (MHz)	Read Level (dBuV)	Factor (dB/m)	Level (dBuV/m)	Limit (dBuV/m)	Over Limit (dB)	Pol.
4924.00	32.15	15.51	47.66	54.00	-6.34	V
7386.00	22.46	17.97	40.43	54.00	-13.57	V
9848.00	23.81	23.82	47.63	54.00	-6.37	V
12310.00	*			54.00		V
14772.00	*			54.00		V
17234.00	*			54.00		V
4924.00	31.41	15.51	46.92	54.00	-7.08	H
7386.00	21.13	17.97	39.10	54.00	-14.90	H
9848.00	20.87	23.82	44.69	54.00	-9.31	H
12310.00	*			54.00		H
14772.00	*			54.00		H
17234.00	*			54.00		H

Remark:

1. During the test, pre-scan the 802.11b,g,n(HT20N) mode, and found the 802.11b mode is worse case , the report only record this mode.
2. Level =Receiver Read level + Factor
3. “*” , means this data is the too weak instrument of signal is unable to test.

Radiated Band Edge:

Test Mode: 802.11b Mode				Test channel: Lowest		
Peak Value						
Frequency (MHz)	Read Level (dBuV)	Factor (dB/m)	Level (dBuV/m)	Limit (dBuV/m)	Over Limit (dB)	Pol.
2390.00	53.51	9.73	63.24	74.00	-10.76	H
2400.00	54.50	9.75	64.25	74.00	-9.75	H
2390.00	54.04	9.73	63.77	74.00	-10.23	V
2400.00	60.81	9.75	70.56	74.00	-3.44	V
Average Value						
Frequency (MHz)	Read Level (dBuV)	Factor (dB/m)	Level (dBuV/m)	Limit (dBuV/m)	Over Limit (dB)	Pol.
2390.00	30.23	9.73	39.96	54.00	-14.04	H
2400.00	31.44	9.75	41.19	54.00	-12.81	H
2390.00	33.95	9.73	43.68	54.00	-10.32	V
2400.00	38.48	9.75	48.23	54.00	-5.77	V

Test Mode: 802.11b Mode				Test channel: Highest		
Peak Value						
Frequency (MHz)	Read Level (dBuV)	Factor (dB/m)	Level (dBuV/m)	Limit (dBuV/m)	Over Limit (dB)	Pol.
2483.50	58.48	9.91	68.21	74.00	-5.79	H
2500.00	59.36	9.75	69.11	74.00	-4.89	H
2483.50	58.51	9.91	68.24	74.00	-5.76	V
2500.00	62.37	9.75	72.12	74.00	-1.88	V
Average Value						
Frequency (MHz)	Read Level (dBuV)	Factor (dB/m)	Level (dBuV/m)	Limit (dBuV/m)	Over Limit (dB)	Pol.
2483.50	40.36	9.91	50.09	54.00	-3.91	H
2500.00	41.49	9.75	51.24	54.00	-2.76	H
2483.50	41.60	9.91	51.33	54.00	-2.67	V
2500.00	42.42	9.75	52.17	54.00	-1.83	V

Remark:

- 1. Level = Receiver Read level + Factor

Radiated Band Edge:

Test Mode: 802.11g Mode				Test channel: Lowest		
Peak Value						
Frequency (MHz)	Read Level (dBuV)	Factor (dB/m)	Level (dBuV/m)	Limit (dBuV/m)	Over Limit (dB)	Pol.
2390.00	61.52	9.73	71.25	74.00	-2.75	H
2400.00	63.70	9.75	73.45	74.00	-0.55	H
2390.00	62.92	9.73	72.65	74.00	-1.35	V
2400.00	62.16	9.75	71.91	74.00	-2.09	V
Average Value						
Frequency (MHz)	Read Level (dBuV)	Factor (dB/m)	Level (dBuV/m)	Limit (dBuV/m)	Over Limit (dB)	Pol.
2390.00	43.34	9.73	53.07	54.00	-0.93	H
2400.00	44.03	9.75	53.78	54.00	-0.22	H
2390.00	43.39	9.73	53.12	54.00	-0.88	V
2400.00	43.52	9.75	53.27	54.00	-0.73	V

Test Mode: 802.11g Mode				Test channel: Highest		
Peak Value						
Frequency (MHz)	Read Level (dBuV)	Factor (dB/m)	Level (dBuV/m)	Limit (dBuV/m)	Over Limit (dB)	Pol.
2483.50	63.72	9.91	73.45	74.00	-0.55	H
2500.00	63.23	9.75	72.98	74.00	-1.02	H
2483.50	63.16	9.91	72.89	74.00	-1.11	V
2500.00	63.51	9.75	73.26	74.00	-0.74	V
Average Value						
Frequency (MHz)	Read Level (dBuV)	Factor (dB/m)	Level (dBuV/m)	Limit (dBuV/m)	Over Limit (dB)	Pol.
2483.50	42.91	9.91	52.64	54.00	-1.36	H
2500.00	43.30	9.75	53.05	54.00	-0.95	H
2483.50	42.46	9.91	52.19	54.00	-1.81	V
2500.00	43.57	9.75	53.32	54.00	-0.68	V

Remark:

1. Level = Receiver Read level + Factor

Radiated Band Edge:

Test Mode: 802.11n20 Mode				Test channel: Lowest		
Peak Value						
Frequency (MHz)	Read Level (dBuV)	Factor (dB/m)	Level (dBuV/m)	Limit (dBuV/m)	Over Limit (dB)	Pol.
2390.00	63.26	9.73	72.99	74.00	-1.01	H
2400.00	63.49	9.75	73.24	74.00	-0.76	H
2390.00	62.42	9.73	72.15	74.00	-1.85	V
2400.00	63.49	9.75	73.24	74.00	-0.76	V
Average Value						
Frequency (MHz)	Read Level (dBuV)	Factor (dB/m)	Level (dBuV/m)	Limit (dBuV/m)	Over Limit (dB)	Pol.
2390.00	43.51	9.73	53.24	54.00	-0.76	H
2400.00	42.93	9.75	52.68	54.00	-1.32	H
2390.00	42.96	9.73	52.69	54.00	-1.31	V
2400.00	43.46	9.75	53.21	54.00	-0.79	V

Test Mode: 802.11n20 Mode				Test channel: Highest		
Peak Value						
Frequency (MHz)	Read Level (dBuV)	Factor (dB/m)	Level (dBuV/m)	Limit (dBuV/m)	Over Limit (dB)	Pol.
2483.50	63.24	9.91	72.97	74.00	-1.03	H
2500.00	63.26	9.75	73.01	74.00	-0.99	H
2483.50	62.46	9.91	72.19	74.00	-1.81	V
2500.00	63.49	9.75	73.24	74.00	-0.76	V
Average Value						
Frequency (MHz)	Read Level (dBuV)	Factor (dB/m)	Level (dBuV/m)	Limit (dBuV/m)	Over Limit (dB)	Pol.
2483.50	43.33	9.91	53.06	54.00	-0.94	H
2500.00	43.45	9.75	53.20	54.00	-0.80	H
2483.50	42.95	9.91	52.68	54.00	-1.32	V
2500.00	43.15	9.75	52.90	54.00	-1.10	V

Remark:

1. Level = Receiver Read level + Factor

5. Maximum Peak Output Power Test

5.1. Test Standard and Limit

Test Standard	FCC Part15 C Section 15.247 (b)(3)
Test Limit	30dBm

5.2. Test Setup

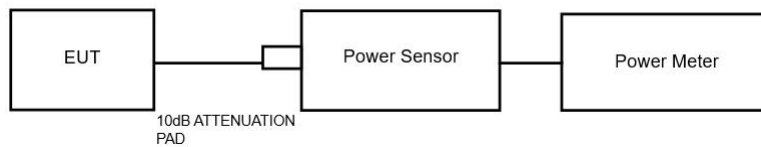

5.3. Test Procedure

1. The Transmitter output (antenna port) was connected to the power meter.
2. Turn on the EUT and power meter and then record the power value.
3. Repeat above procedures on all channels needed to be tested.

Note: The cable loss and attenuator loss were offset into measure device as amplitude offset.

5.4. Test Data

Test Item	: Max. peak output power	Test Mode	: CH Low ~ CH High
Test Voltage	: AC 120V, 60Hz for Adapter	Temperature	: 23.2°C
Test Result	: PASS	Humidity	: 55%RH

Test Channel	Frequency (MHz)	Maximum Peak Conducted Output Power(PK) (dBm)	Maximum Average Conducted Output Power(AV) (dBm)	Limit dBm	Results
TX 802.11b Mode					
CH01	2412	23.83	23.38	30	PASS
CH06	2437	23.90	23.90	30	PASS
CH11	2462	23.51	23.41	30	PASS
TX 802.11g Mode					
CH01	2412	18.60	18.38	30	PASS
CH06	2437	18.95	18.31	30	PASS
CH11	2462	18.40	18.05	30	PASS
TX 802.11n(20) Mode					
CH01	2412	20.09	19.30	30	PASS
CH06	2437	20.06	19.32	30	PASS
CH11	2462	20.23	18.85	30	PASS

**Note: For power test the duty cycle is >98% in continuous transmitting mode.
Please see the plot of next page**

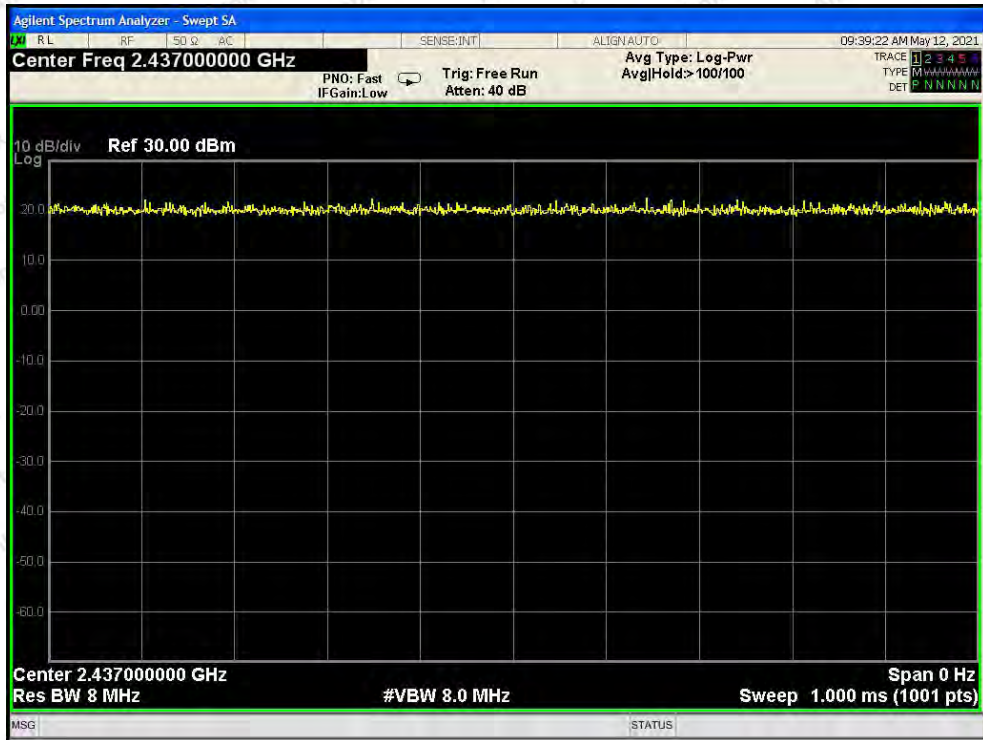

802.11n(HT20) mode

6. 6DB Occupy Bandwidth Test

6.1. Test Standard and Limit

Test Standard	FCC Part15 C Section 15.247 (a)(2)
Test Limit	>500kHz

6.2. Test Setup

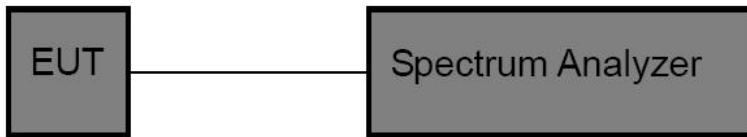

6.3. Test Procedure

1. Place the EUT on the table and set it in the transmitting mode.
2. Remove the antenna from the EUT and then connect a low loss RF cable from the antenna port to the spectrum analyzer.
3. Set the spectrum analyzer as:
 RBW= 100kHz, VBW≥3*RBW =300kHz
 Detector= Peak
 Trace mode= Max hold.
 Sweep= auto couple.
4. Mark the peak frequency and -6dB (upper and lower) frequency.
5. Repeat until all the rest channels are investigated.

6.4. Test Data

Test Item	: 6dB Bandwidth	Test Mode	: CH Low ~ CH High
Test Voltage	: AC 120V, 60Hz for Adapter	Temperature	: 23.2°C
Test Result	: PASS	Humidity	: 55%RH

Mode	Channel	Frequency (MHz)	Bandwidth (MHz)	Limit (kHz)	Results
802.11b	Low	2412	9.074	>500	PASS
	Middle	2437	9.079		PASS
	High	2462	9.070		PASS
802.11g	Low	2412	15.14	>500	PASS
	Middle	2437	15.10		PASS
	High	2462	15.16		PASS
802.11n20	Low	2412	15.14	>500	PASS
	Middle	2437	15.13		PASS
	High	2462	15.16		PASS



802.11b mode : Lowest



802.11b mode : Middle



802.11b mode : Highest



802.11g mode : Lowest



802.11g mode : Middle

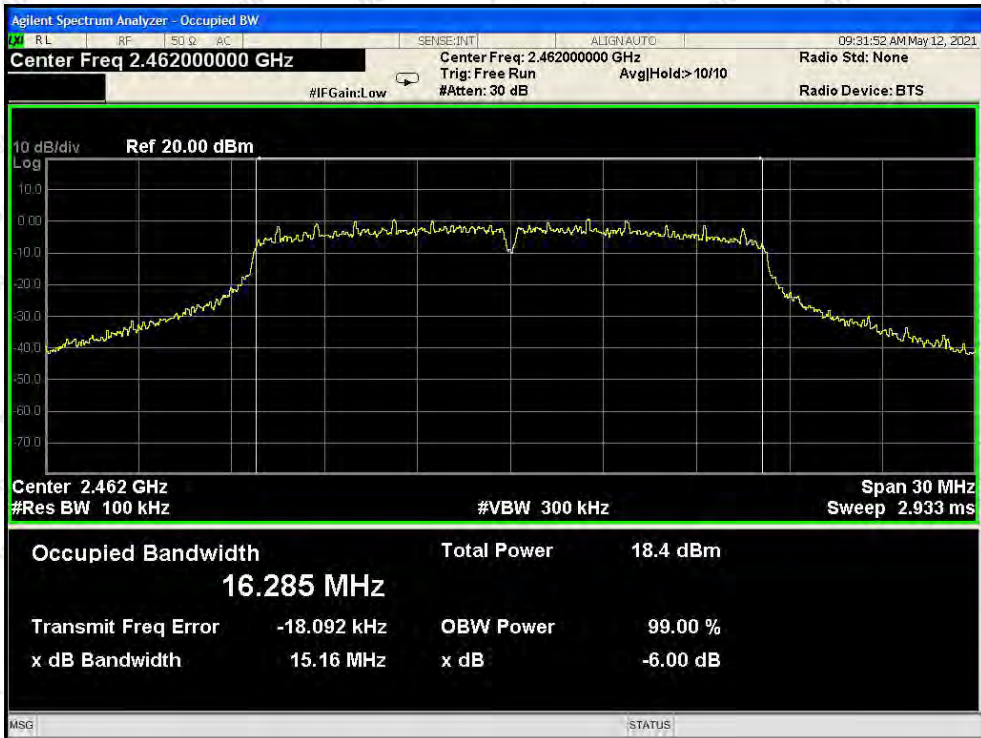

802.11g mode : Highest

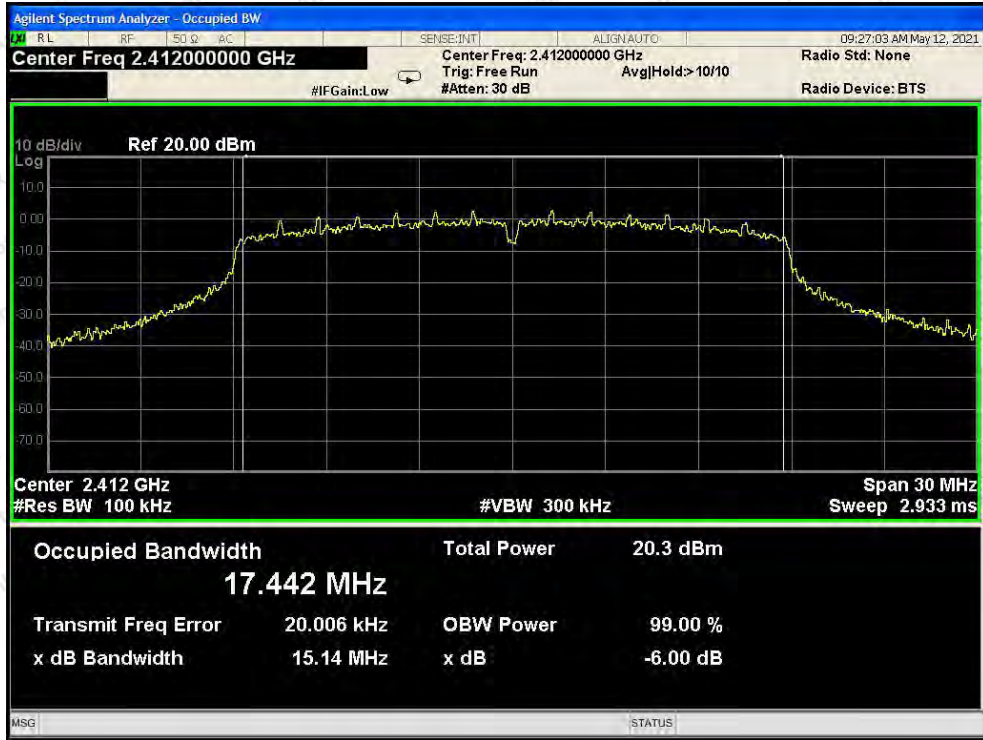

802.11n20 mode : Lowest



802.11n20 mode : Middle

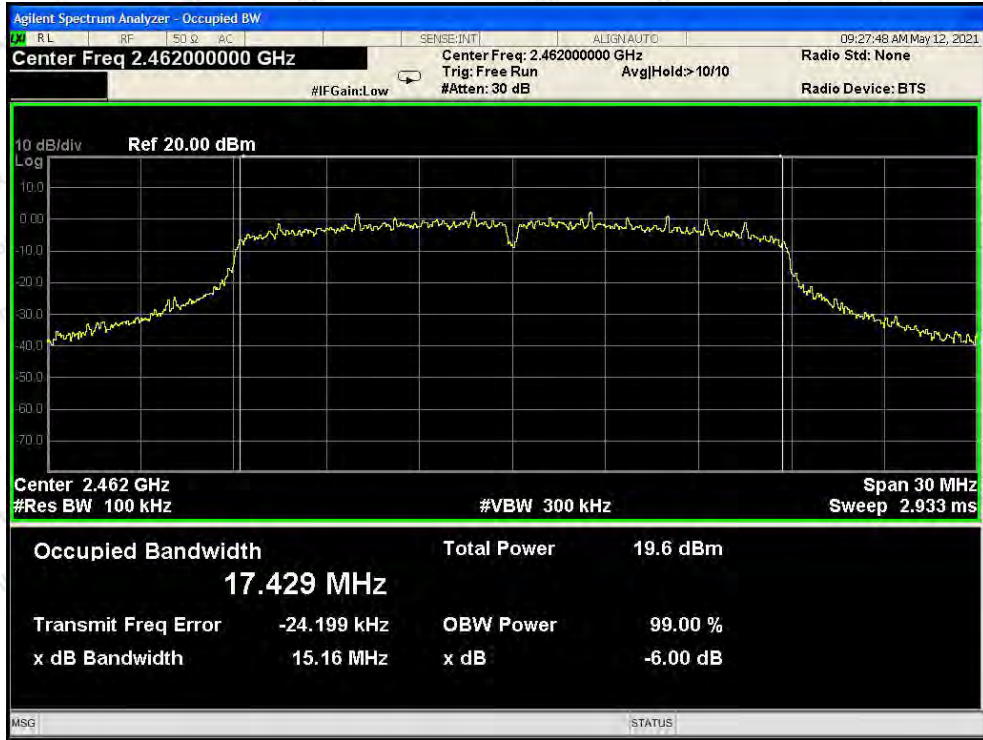

802.11n20 mode : Highest

7. Power Spectral Density Test

7.1. Test Standard and Limit

Test Standard	FCC Part15 C Section
Test Limit	8dBm/3KHz

7.2. Test Setup

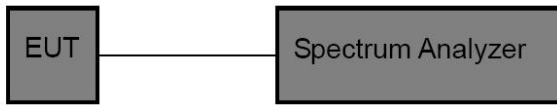

7.3. Test Procedure

1. Place the EUT on the table and set it in transmitting mode. Remove the antenna from the EUT and then connect a low loss RF cable from the antenna port to the spectrum analyzer.
2. Set the spectrum analyzer as RBW = 3kHz, VBW = 10kHz, Span = 1.5xDTS BW
3. Record the max. reading.
4. Repeat the above procedure until the measurements for all frequencies are completed.

7.4. Test Data

Test Item	: Power Spectral Density	Test Mode	: CH Low ~ CH High
Test Voltage	: AC 120V, 60Hz for Adapter	Temperature	: 23.2°C
Test Result	: PASS	Humidity	: 55%RH

Mode	Channel	Frequency (MHz)	PSD (dBm/3KHz)	Limit (dBm/3KHz)	Results
802.11b	Low	2412	-2.598	8.00	PASS
	Middle	2437	-2.521	8.00	PASS
	High	2462	-2.773	8.00	PASS
802.11g	Low	2412	-12.615	8.00	PASS
	Middle	2437	-12.408	8.00	PASS
	High	2462	-13.139	8.00	PASS
802.11n20	Low	2412	-11.188	8.00	PASS
	Middle	2437	-11.429	8.00	PASS
	High	2462	-12.248	8.00	PASS



802.11b mode : Lowest



802.11b mod : Middle



802.11b mode : Highest

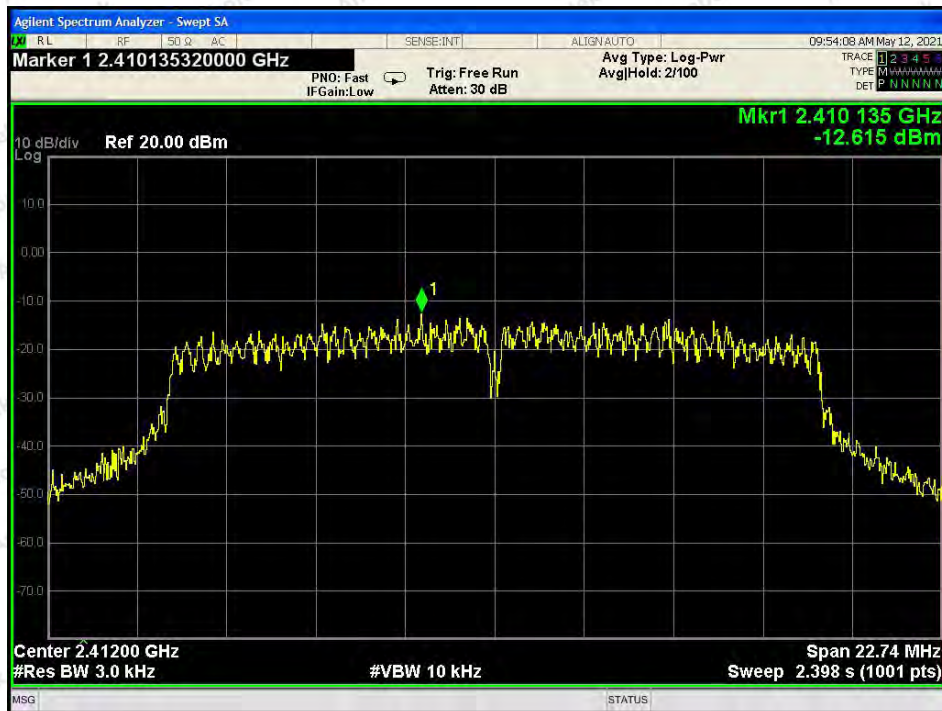

802.11g mode : Lowest

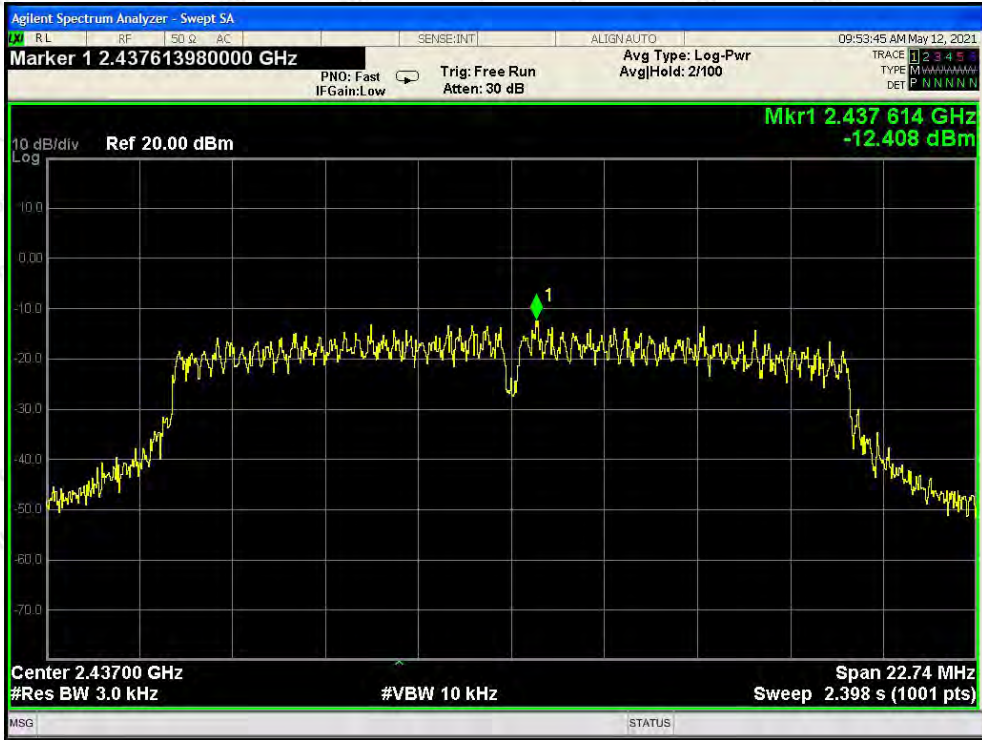

802.11g mode : Middle



802.11g mode : Highest

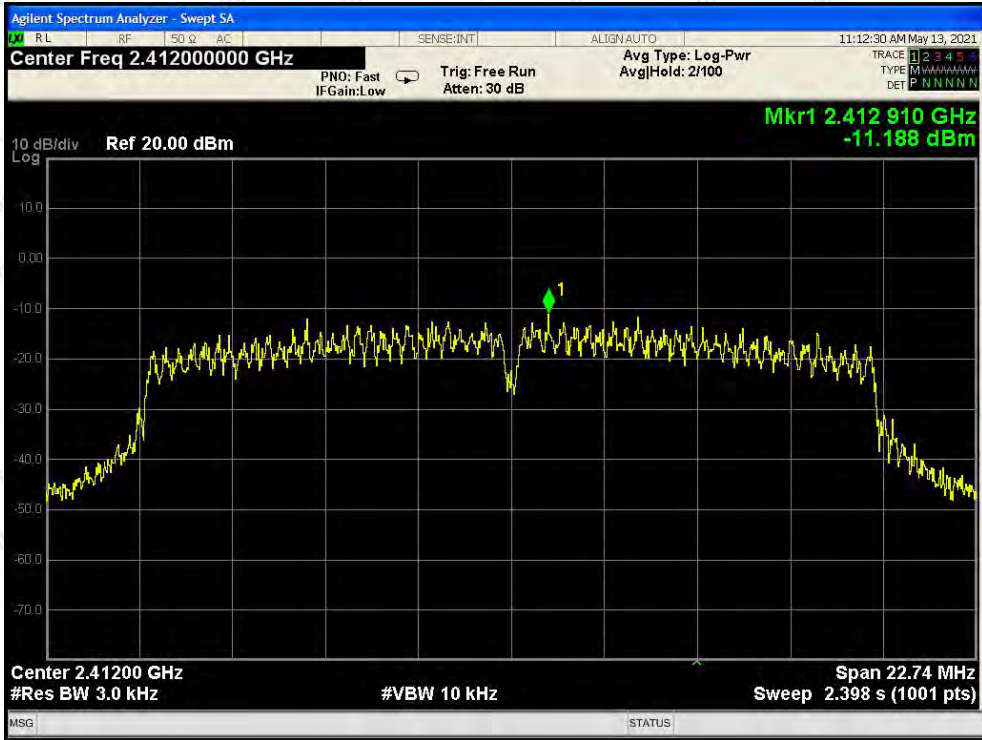

802.11n20 mode : Lowest

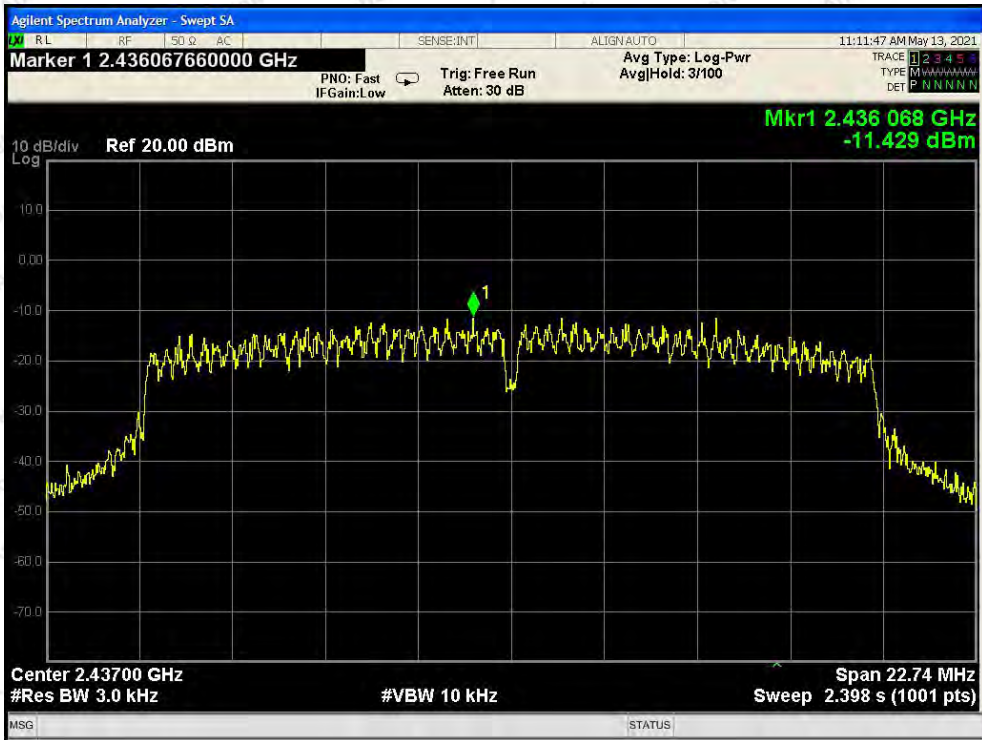

802.11n20 mode : Middle

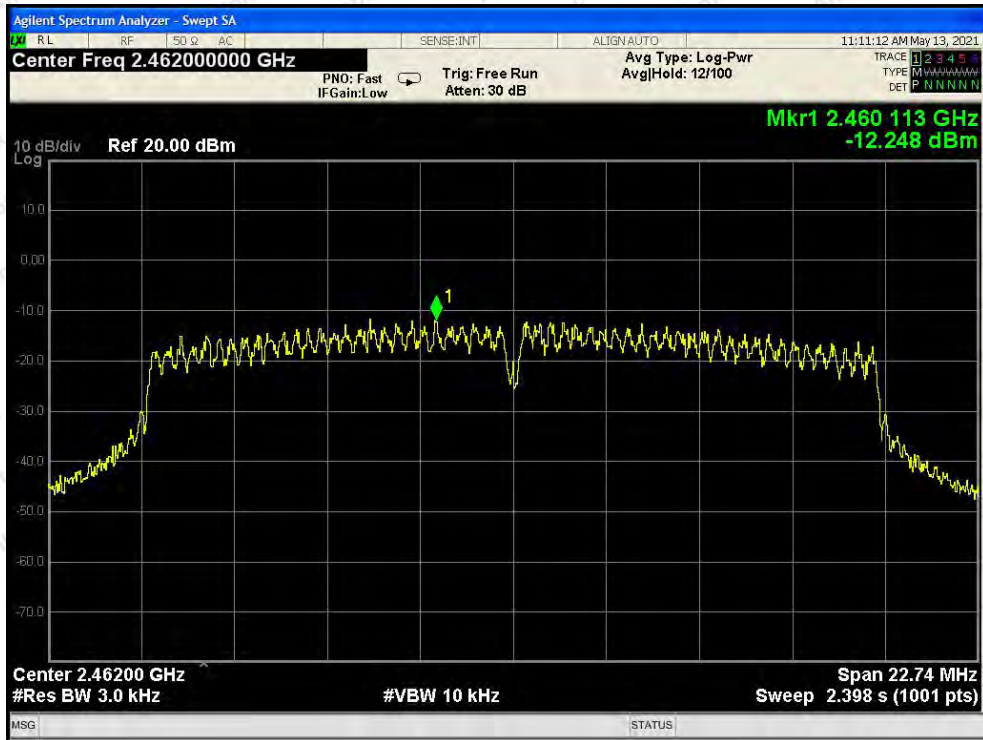

802.11n20 mode : Highest

8. 100kHz Bandwidth of Frequency Band Edge Requirement

8.1. Test Standard and Limit

Test Standard	FCC Part15 C Section 15.247 (d)
Test Limit	in any 100 kHz bandwidth outside the frequency bands in which the spread spectrum intentional radiator is operating, the radio frequency power that is produced by the intentional radiator shall be at least 20dB below that in the 100kHz bandwidth within the band that contains the highest level of the desired power, In addition, radiated emissions which fall in the restricted bands, as defined in §15.205(a), must also comply with the radiated emission limits specified in 15.209(a).

8.2. Test Setup

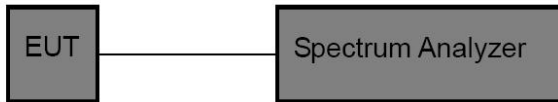

8.3. Test Procedure

Using the following spectrum analyzer setting:

1. Set the RBW = 100KHz.
2. Set the VBW = 300KHz.
3. Sweep time = auto couple.
4. Detector function = peak.
5. Trace mode = max hold.
6. Allow trace to fully stabilize.

8.4. Test Data

Test Item	:	Band edge
Test Voltage	:	AC 120V, 60Hz for Adapter
Test Result	:	PASS

Test Mode	:	CH Low ~ CH High
Temperature	:	23.2°C
Humidity	:	55%RH



802.11b mode : Lowest



802.11b mode : Highest



802.11g mode : Lowest



802.11g mode : Highest



802.11n20 mode : Lowest



802.11n20 mode : Highest

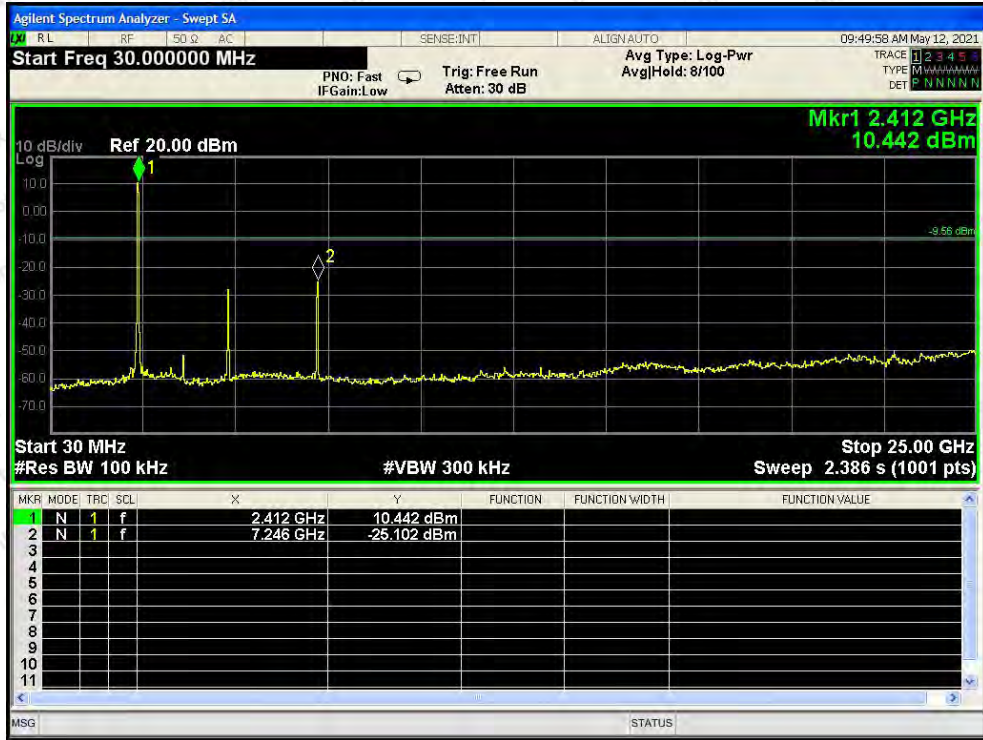

802.11b mode : Lowest

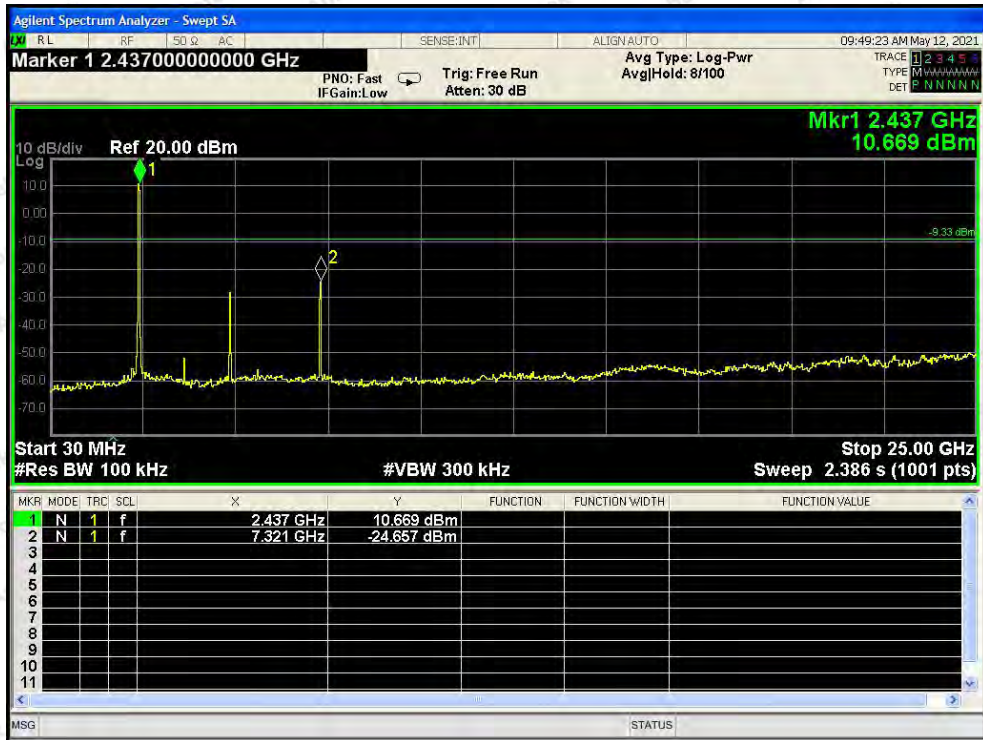

802.11b mode : Middle

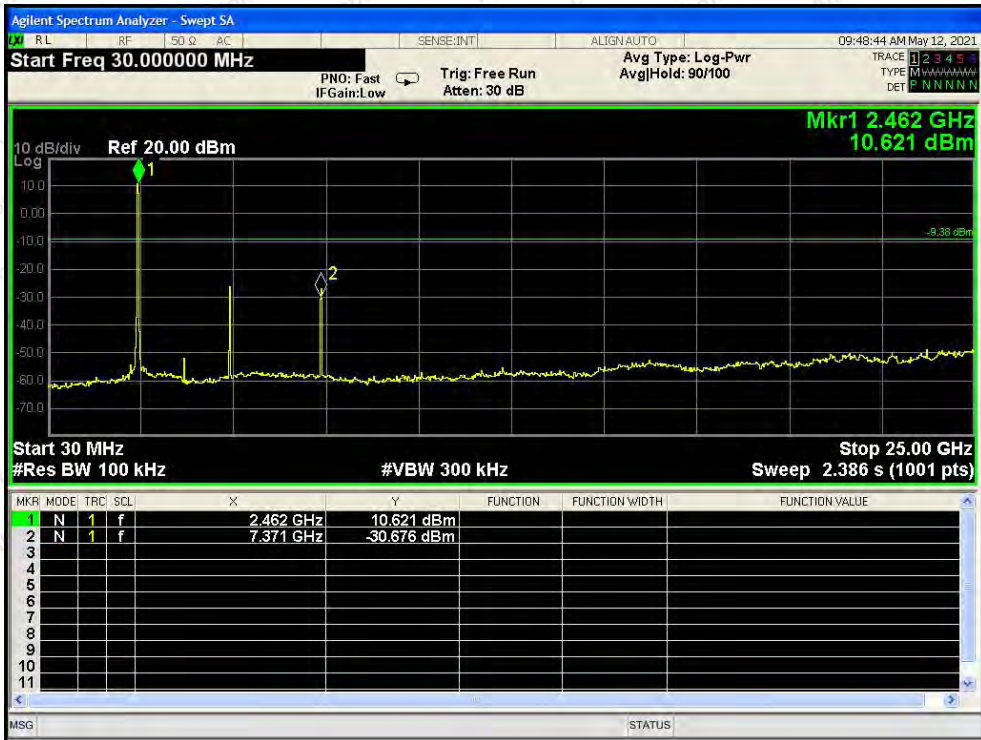

802.11b mode : Highest

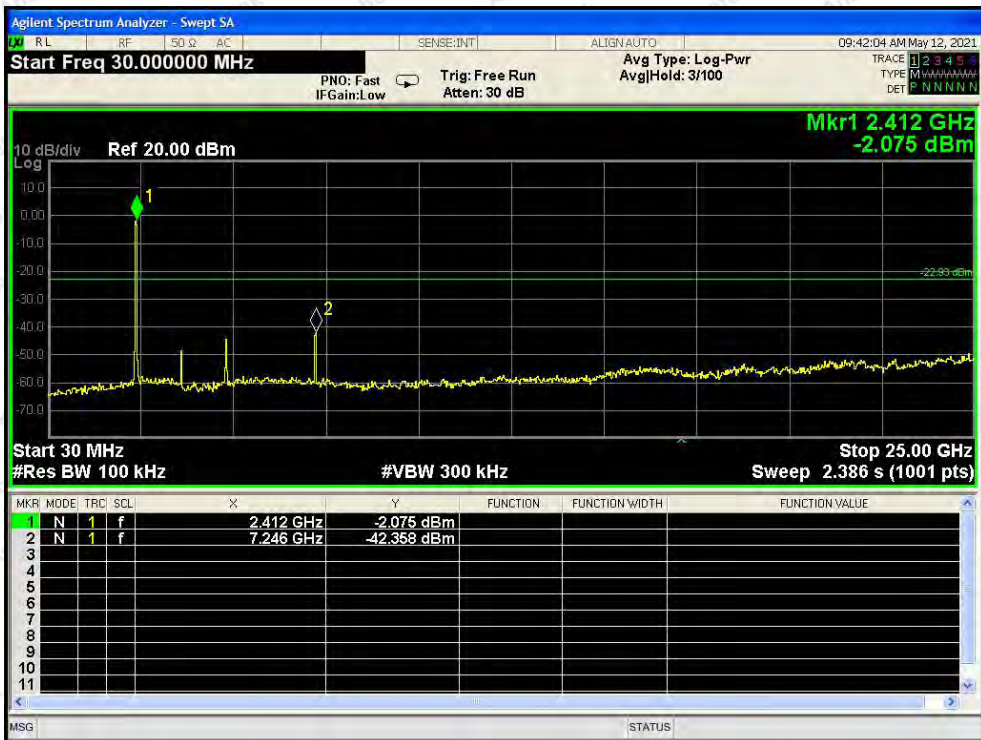

802.11g mode : Lowest

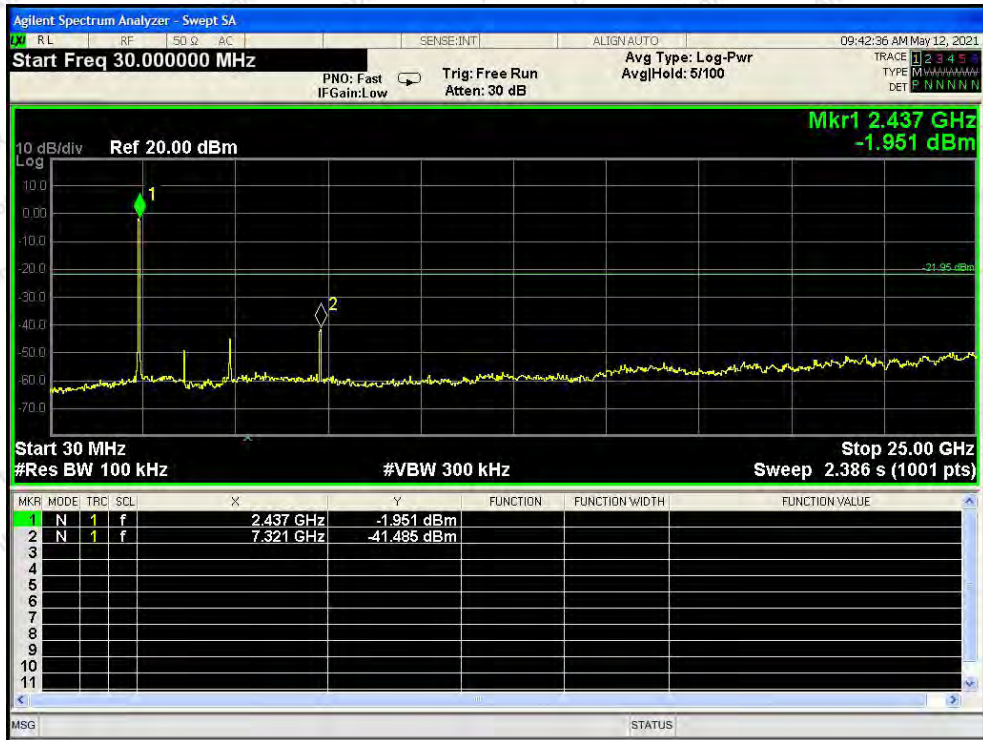

802.11g mode : Middle

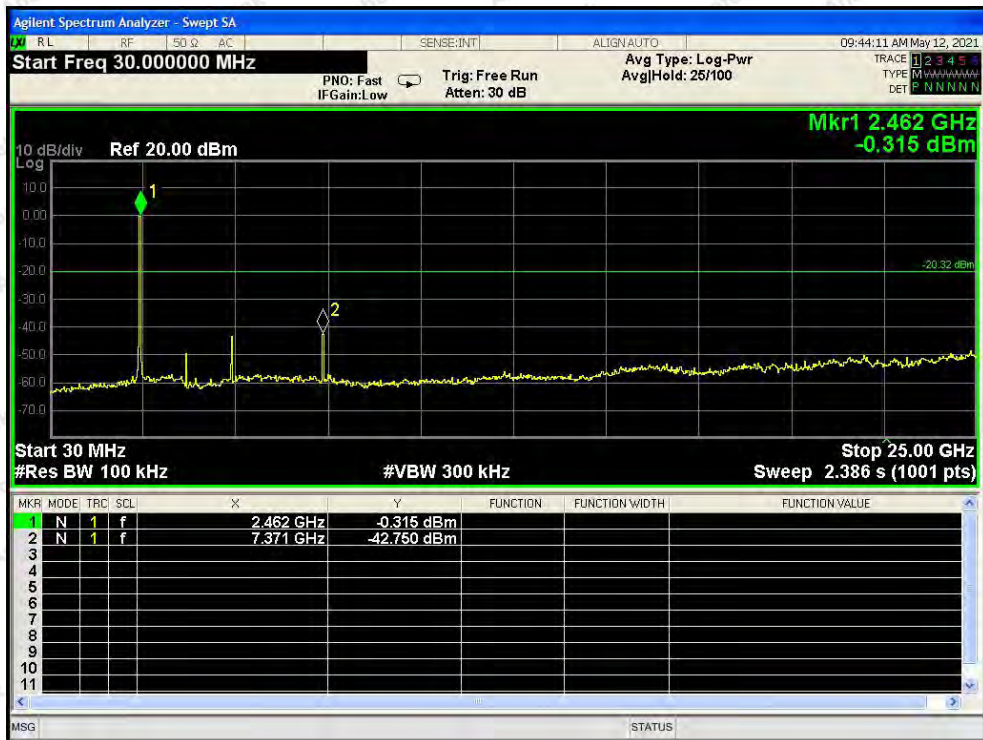

802.11g mode : Highest

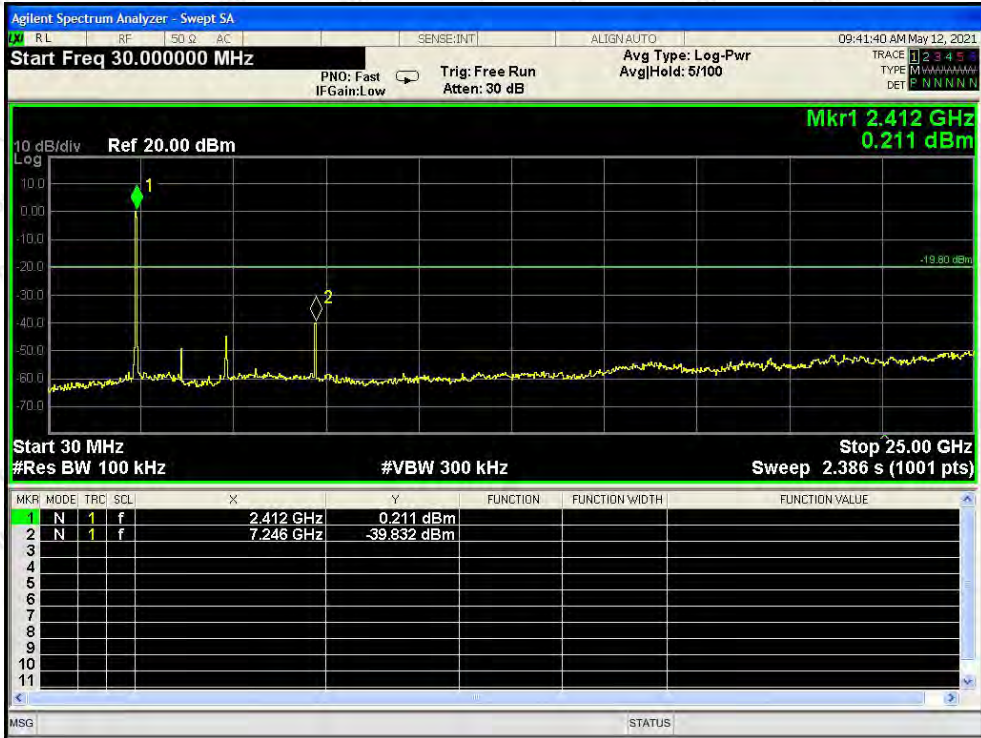

802.11n20 mode : Lowest

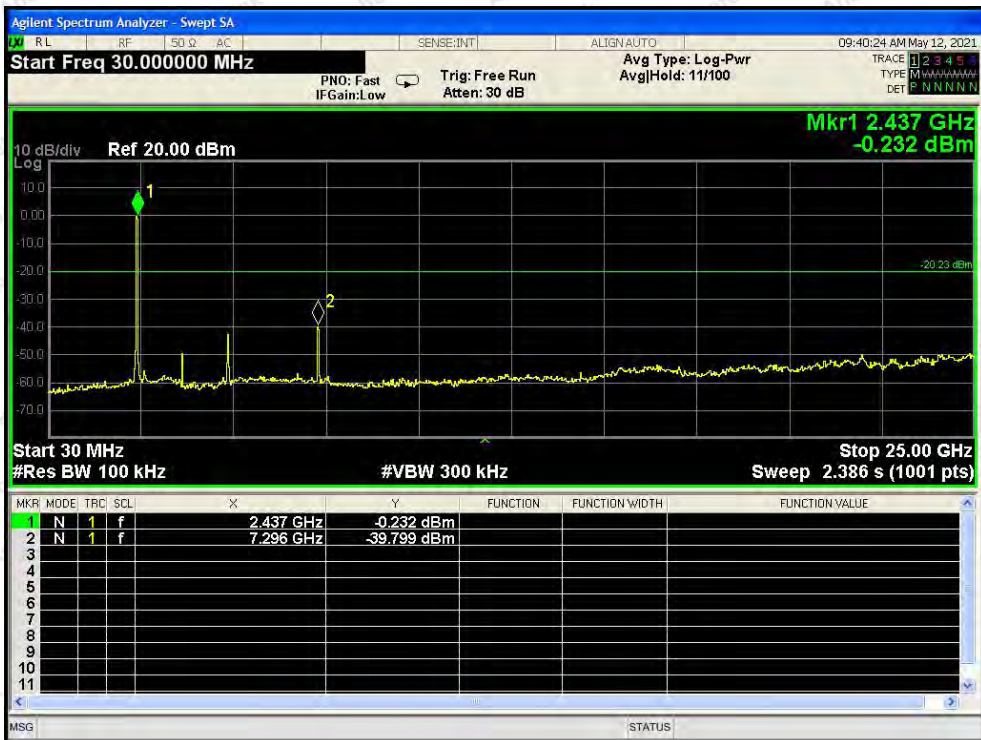

802.11n20 mode : Middle

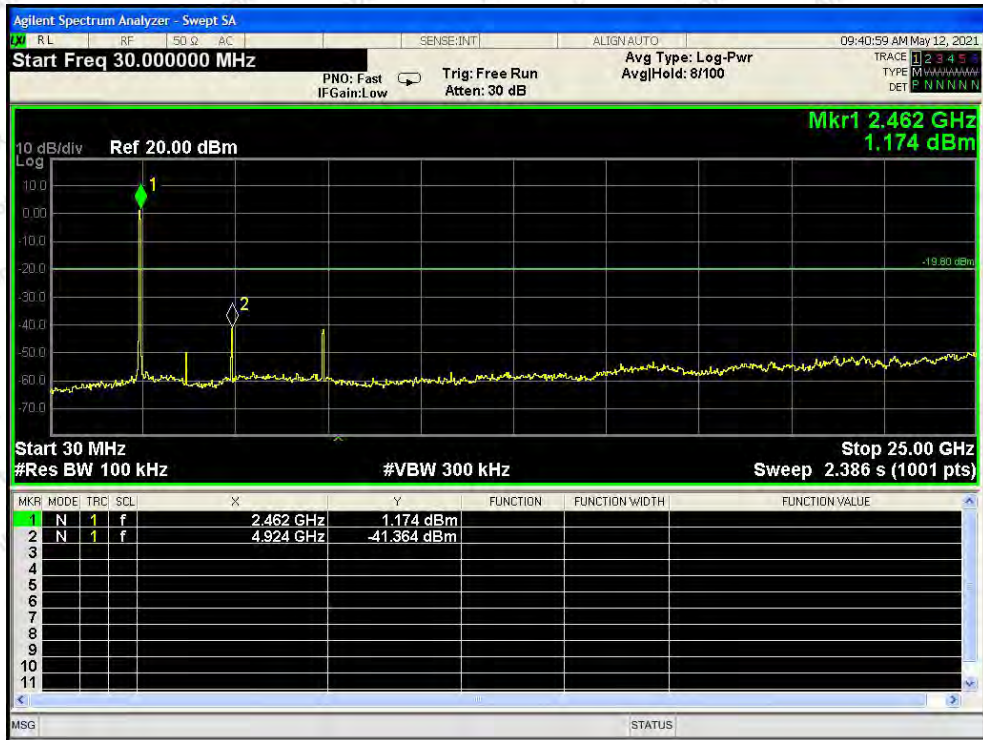

802.11n20 mode : Highest

9. Antenna Requirement

9.1. Test Standard and Requirement

Test Standard	FCC Part15 Section 15.203 /247(c)
Requirement	<p>1) 15.203 requirement: An intentional radiator shall be designed to ensure that no antenna other than that furnished by the responsible party shall be used with the device. The use of a permanently attached antenna or of an antenna that uses a unique coupling to the intentional radiator, the manufacturer may design the unit so that a broken antenna can be replaced by the user, but the use of a standard antenna jack or electrical connector is prohibited.</p> <p>2) 15.247(c) (1)(i) requirement: Systems operating in the 2400-2483.5 MHz band that is used exclusively for fixed. Point-to-point operations may employ transmitting antennas with directional gain greater than 6dBi provided the maximum conducted output power of the intentional radiator is reduced by 1 dB for every 3 dB that the directional gain of the antenna exceeds 6 dBi.</p>

9.2. Antenna Connected Construction

The antenna is a Metal antenna which permanently attached, and the best case gain of the antenna is 2.9dBi It complies with the standard requirement.

APPENDIX I -- TEST SETUP PHOTOGRAPH

Please refer to separated files for Test Setup Photos of the EUT.

APPENDIX II -- EXTERNAL PHOTOGRAPH

Please refer to separated files for External Photos of the EUT.

APPENDIX III -- INTERNAL PHOTOGRAPH

Please refer to separated files for Internal Photos of the EUT.

----- End of Report -----

