

# FCC SAR Test Report

**Applicant** : **Anker Innovations Limited**

**Address** : **Unit 56, 8th Floor, Tower 2, Admiralty Centre,  
18 Harcourt Road, Hong Kong**

**Product Name** : **eufy Standalone Monitor**

**Report Date** : **Sept. 20, 2024**



**Shenzhen Anbotek Compliance Laboratory Limited**

**Shenzhen Anbotek Compliance Laboratory Limited**

Address: Sogood Industrial Zone Laboratory & 1/F. of Building D, Sogood Science and Technology Park,  
Sanwei Community, Hangcheng Subdistrict, Bao'an District, Shenzhen, Guangdong, China.  
Tel:(86)0755-26066440 Email:service@anbotek.com



Hotline  
400-003-0500

www.anbotek.com



# Contents

1. Statement of Compliance	6
2. General Information	7
2.1. Client Information	7
2.2. Description of Equipment Under Test (EUT)	7
2.3. Device Category and SAR Limits	8
2.4. Applied Standard	8
2.5. Environment of Test Site	8
2.6. Test Configuration	8
3. Specific Absorption Rate (SAR)	9
3.1. Introduction	9
3.2. SAR Definition	9
4. SAR Measurement System	10
4.1. E-Field Probe	11
4.2. Data Acquisition Electronics (DAE)	11
4.3. Robot	12
4.4. Measurement Server	12
4.5. Phantom	13
4.6. Device Holder	14
4.7. Data Storage and Evaluation	14
5. Test Equipment List	17
6. Tissue Simulating Liquids	18
7. System Verification Procedures	19
8. EUT Testing Position	21
8.1. Body Position	21
9. Measurement Procedures	22
9.1. Spatial Peak SAR Evaluation	22
9.2. Power Reference Measurement	23
9.3. Area Scan Procedures	23
9.4. Zoom Scan Procedures	24
9.5. Volume Scan Procedures	25
9.6. Power Drift Monitoring	25
10. Conducted Power	26
11. Antenna Location	27
12. SAR Test Results Summary	28
12.1. Body-worn SAR Results	29
13. Simultaneous Transmission Analysis	30
14. Measurement Uncertainty	31
Appendix A. EUT Photos and Test Setup Photos	33

**Shenzhen Anbotek Compliance Laboratory Limited**



Appendix B. Plots of SAR System Check..... 34  
Appendix C. Plots of SAR Test Data..... 35  
Appendix A. DASY System Calibration Certificate..... 37



# TEST REPORT

Applicant : Anker Innovations Limited  
Manufacturer : Anker Innovations Limited  
Product Name : eufy Standalone Monitor  
Model No. : T8353  
Trade Mark : eufy  
Rating(s) : Input: 5V=2A  
Battery capacity: DC 3.69V, 4700mAh

**Test Standard(s) : IEC/IEEE 62209-1528:2020; FCC 47 CFR Part 2.1093;  
ANSI/IEEE C95.1:2005; Reference FCC KDB 447498;  
KDB 248227; KDB 616217;**

The device described above is tested by Shenzhen Anbotek Compliance Laboratory Limited to determine the maximum emission levels emanating from the device and the severe levels of the device can endure and its performance criterion. The measurement results are contained in this test report and Shenzhen Anbotek Compliance Laboratory Limited is assumed full of responsibility for the accuracy and completeness of these measurements. Also, this report shows that the EUT (Equipment Under Test) is technically compliant with the IEC/IEEE 62209-1528:2020, FCC 47 CFR Part 2.1093, IEEE Std C95.1-2019 requirements.

This report applies to above tested sample only and shall not be reproduced in part without written approval of Shenzhen Anbotek Compliance Laboratory Limited.

Date of Receipt Jul. 12, 2024  
Date of Test Jul. 12, 2024 to Aug. 16, 2024

Prepared By *Ella Liang*  
\_\_\_\_\_  
(Ella Liang)

Test Engineer *Tony Luo*  
\_\_\_\_\_  
(Tony Luo)

Approved & Authorized Signer *Edward Pan*  
\_\_\_\_\_  
(Edward Pan)

**Shenzhen Anbotek Compliance Laboratory Limited**

Address: Sogood Industrial Zone Laboratory & 1/F. of Building D, Sogood Science and Technology Park, Sanwei Community, Hangcheng Subdistrict, Bao'an District, Shenzhen, Guangdong, China.  
Tel:(86)0755-26066440 Email:service@anbotek.com

Hotline 400-003-0500  
www.anbotek.com



### Version

Version No.	Date	Description
R00	Sept. 20, 2024	Original



# 1. Statement of Compliance

## <Highest SAR Summary>

This device is in compliance with Specific Absorption Rate (SAR) for general population/uncontrolled exposure limits (1.6 W/kg) specified in FCC 47 CFR part 2.1093 and IEEE Std C95.1-2019, and had been tested in accordance with the measurement methods and procedures specified in IEC/IEEE 62209-1528:2020. The maximum results of Specific Absorption Rate (SAR) found during testing are as follows.

## <Highest SAR Summary>

Frequency Band	Highest Reported 1g-SAR(W/Kg)	SAR Test Limit (W/Kg)
	Body-worn (0mm)	
WLAN2.4G Horizontal	0.398	1.6
WLAN2.4G Bends 90 degrees	0.365	
Test Result	PASS	

This device is in compliance with Specific Absorption Rate (SAR) for general population/uncontrolled exposure limits (1.6 W/kg) specified in FCC 47 CFR part 2.1093 and IEEE Std C95.1-2019, and had been tested in accordance with the measurement methods and procedures specified in IEC/IEEE 62209-1528:2020.



## 2. General Information

### 2.1. Client Information

Applicant	:	Anker Innovations Limited
Address	:	Unit 56, 8th Floor, Tower 2, Admiralty Centre, 18 Harcourt Road, Hong Kong
Manufacturer	:	Anker Innovations Limited
Address	:	Unit 56, 8th Floor, Tower 2, Admiralty Centre, 18 Harcourt Road, Hong Kong

### 2.2. Description of Equipment Under Test (EUT)

Product Name	:	eufy Standalone Monitor
Model No.	:	T8353
Trade Mark	:	eufy
Test Power Supply	:	DC 5V from adapter input AC 120V/60Hz; DC 3.69V battery inside
Test Sample No.	:	1-2-2(Engineering Sample)
Tx Frequency	:	2.4G WIFI: 2412-2462MHz
Type of Modulation	:	2.4G WIFI: CCK, DQPSK, DBPSK,BPSK, QPSK, 16QAM, 64QAM, 256QAM,1024QAM
Category of device	:	Portable device
<b>Remark:</b> The above DUT's information was declared by manufacturer. Please refer to the specifications or user's manual for more detailed description.		



### 2.3. Device Category and SAR Limits

This device belongs to portable device category because its radiating structure is allowed to be used within 20 centimeters of the body of the user. Limit for General Population/Uncontrolled exposure should be applied for this device, it is 1.6 W/kg as averaged over any 1 gram of tissue.

### 2.4. Applied Standard

The Specific Absorption Rate (SAR) testing specification, method, and procedure for this device is in accordance with the following standards:

- FCC 47 CFR Part 2.1093
- IEEE Std C95.1-2019
- IEC/IEEE 62209-1528:2020
- KDB 865664 D01 SAR Measurement 100 MHz to 6 GHz v01r04
- KDB 447498 D01 General RF Exposure Guidance v06
- KDB 248227 D01 802.11 Wi-Fi SAR v02r02

### 2.5. Environment of Test Site

Items	Required	Actual
Temperature (°C)	18-25	22~23
Humidity (%RH)	30-70	55~65

### 2.6. Test Configuration

The device was controlled by using a base station emulator. Communication between the device and the emulator was established by air link. The distance between the EUT and the antenna of the emulator is larger than 50 cm and the output power radiated from the emulator antenna is at least 30 dB smaller than the output power of EUT. The EUT was set from the emulator to radiate maximum output power during all tests. For WLAN SAR testing, WLAN engineering testing software installed on the EUT can provide continuous transmitting RF signal.





### 3. Specific Absorption Rate (SAR)

#### 3.1. Introduction

SAR is related to the rate at which energy is absorbed per unit mass in an object exposed to a radio field. The SAR distribution in a biological body is complicated and is usually carried out by experimental techniques or numerical modeling. The standard recommends limits for two tiers of groups, occupational/controlled and general population/uncontrolled, based on a person's awareness and ability to exercise control over his or her exposure. In general, occupational/controlled exposure limits are higher than the limits for general population/uncontrolled.

#### 3.2. SAR Definition

The SAR definition is the time derivative (rate) of the incremental energy (dW) absorbed by (dissipated in) an incremental mass (dm) contained in a volume element (dv) of a given density ( $\rho$ ). The equation description is as below:

$$\text{SAR} = \frac{d}{dt} \left( \frac{dW}{dm} \right) = \frac{d}{dt} \left( \frac{dW}{\rho dv} \right)$$

SAR is expressed in units of Watts per kilogram (W/kg)

SAR measurement can be either related to the temperature elevation in tissue by

$$\text{SAR} = C \left( \frac{\delta T}{\delta t} \right)$$

Where: C is the specific heat capacity,  $\delta T$  is the temperature rise and  $\delta t$  is the exposure duration, or related to the electrical field in the tissue by

$$\text{SAR} = \frac{\sigma |E|^2}{\rho}$$

Where:  $\sigma$  is the conductivity of the tissue,  $\rho$  is the mass density of the tissue and E is the RMS electrical field strength.

However for evaluating SAR of low power transmitter, electrical field measurement is typically applied.



## 4. SAR Measurement System

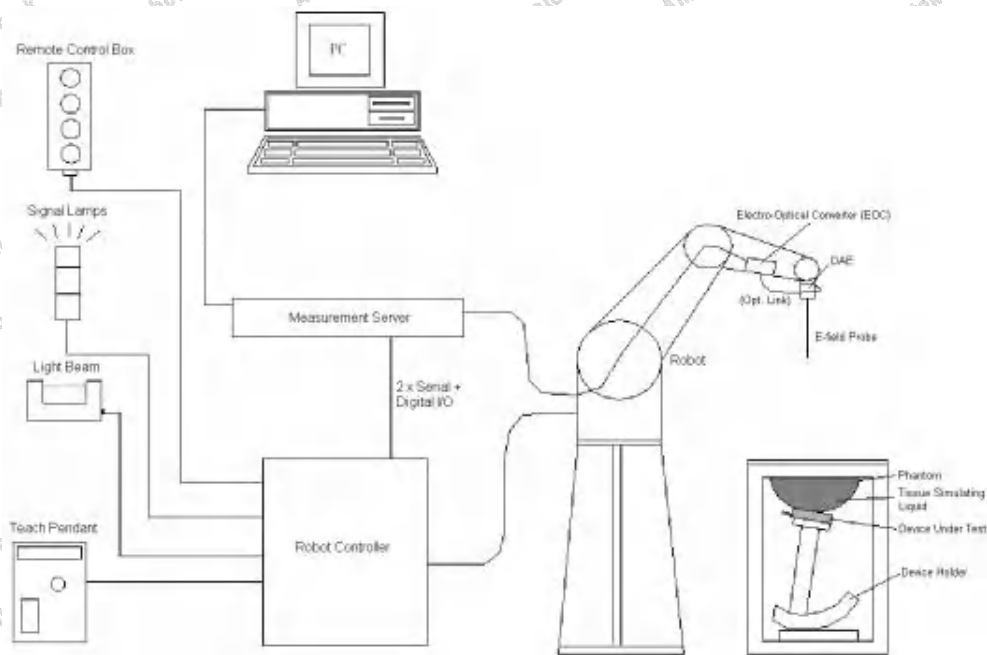

### DASY System Configurations

The DASYsystem for performance compliance tests is illustrated above graphically. This system consists of the following items:

- A standard high precision 6-axis robot with controller, a teach pendant and software
- A data acquisition electronic (DAE) attached to the robot arm extension
- A dosimetric probe equipped with an optical surface detector system
- The electro-optical converter (EOC) performs the conversion between optical and electrical signals
- A measurement server performs the time critical tasks such as signal filtering, control of the robot operation and fast movement interrupts.
- A probe alignment unit which improves the accuracy of the probe positioning
- A computer operating Windows XP
- DASY software
- Remote control with teach pendant and additional circuitry for robot safety such as warning lamps, etc.
- The SAM twin phantom
- A device holder
- Tissue simulating liquid
- Dipole for evaluating the proper functioning of the system

components are described in details in the following sub-sections.



**4.1. E-Field Probe**

The SAR measurement is conducted with the dosimetric probe (manufactured by SPEAG).The probe is specially designed and calibrated for use in liquid with high permittivity. The dosimetric probe has special calibration in liquid at different frequency. This probe has a built in optical surface detection system to prevent from collision with phantom.

➤ **E-Field Probe Specification**

**<EX3DV4 Probe>**

<b>Construction</b>	Symmetrical design with triangular core Built-in shielding against static charges PEEK enclosure material (resistant to organic solvents, e.g., DGBE)	 <p><b>Photo of EX3DV4</b></p>
<b>Frequency</b>	10 MHz to 6 GHz; Linearity: ± 0.2 dB	
<b>Directivity</b>	± 0.3 dB in HSL (rotation around probe axis) ± 0.5 dB in tissue material (rotation normal to probe axis)	
<b>Dynamic Range</b>	10 µW/g to 100 W/kg; Linearity: ± 0.2 dB (noise: typically< 1 µW/g)	
<b>Dimensions</b>	Overall length: 330 mm (Tip: 20 mm) Tip diameter: 2.5 mm (Body: 12 mm) Typical distance from probe tip to dipole centers: 1 mm	

➤ **E-Field Probe Calibration**

Each probe needs to be calibrated according to a dosimetric assessment procedure with accuracy better than ± 10%. The spherical isotropy shall be evaluated and within ± 0.25dB. The sensitivity parameters (NormX, NormY, and NormZ), the diode compression parameter (DCP) and the conversion factor (ConvF) of the probe are tested. The calibration data can be referred to appendix C of this report.

**4.2. Data Acquisition Electronics (DAE)**

The data acquisition electronics (DAE) consists of a highly sensitive electrometer-grade preamplifier with auto-zeroing, a channel and gain-switching multiplexer, a fast 16 bit AD-converter and a command decoder and control logic unit. Transmission to the measurement server is accomplished through an optical downlink for data and status information as well as an optical uplink for commands and the clock.

The input impedance of the DAE is 200MOhm; the inputs are symmetrical and floating. Common mode rejection is above 80dB.





Photo of DAE

### 4.3. Robot

The SPEAG DASY system uses the high precision robots (DASY5: TX60XL) type from Stäubli SA (France). For the 6-axis controllersystem, the robot controller version (DASY5: CS8c) from Stäubli is used. The Stäublirobot series have many features that are important for our application:

- High precision (repeatability  $\pm 0.035$  mm)
- High reliability (industrial design)
- Jerk-free straight movements
- Low ELF interference (the closed metallic construction shields against motor control fields)



Photo of DASY5

### 4.4. Measurement Server

The measurement server is based on a PC/104 CPU board with CPU (DASY5: 400 MHz, Intel Celeron), chipdisk (DASY5: 128 MB), RAM (DASY5: 128 MB). The necessary circuits for communication with the DAE electronic box, as well as the 16 bit AD converter system for optical detection and digital I/O interface are contained on the DASY I/O board, which is directly connected to the PC/104 bus of the CPU board.

The measurement server performs all the real-time data evaluation for field measurements and surface detection, controls robot movements and handles safety operations.

#### Shenzhen Anbotek Compliance Laboratory Limited





Photo of Server for DASY5

**4.5. Phantom**  
**<SAM Twin Phantom>**

<b>Shell Thickness</b>	2 ± 0.2 mm; Center ear point: 6 ± 0.2 mm	 <p style="text-align: center;"><b>Photo of SAM Phantom</b></p>
<b>Filling Volume</b>	Approx. 25 liters	
<b>Dimensions</b>	Length: 1000 mm; Width: 500 mm; Height: adjustable feet	
<b>Measurement Areas</b>	Left Hand, Right Hand, Flat Phantom	

The bottom plate contains three pair of bolts for locking the device holder. The device holder positions are adjusted to the standard measurement positions in the three sections. A white cover is provided to tap the phantom during off-periods to prevent water evaporation and changes in the liquid parameters. On the phantom top, three reference markers are provided to identify the phantom position with respect to the robot.

**<ELI4 Phantom>**

<b>Shell Thickness</b>	2 ± 0.2 mm (sagging: <1%)	 <p style="text-align: center;"><b>Photo of ELI4 Phantom</b></p>
<b>Filling Volume</b>	Approx. 30 liters	
<b>Dimensions</b>	Major ellipse axis: 600 mm Minor axis: 400 mm	

The ELI4 phantom is intended for compliance testing of handheld and body-mounted wireless devices in the frequency range of 30 MHz to 6 GHz. ELI4 is fully compatible with standard and all known tissue simulating liquids.



#### 4.6. Device Holder

The SAR in the phantom is approximately inversely proportional to the square of the distance between the source and the liquid surface. For a source at 5 mm distance, a positioning uncertainty of  $\pm 0.5\text{mm}$  would produce a SAR uncertainty of  $\pm 20\%$ . Accurate device positioning is therefore crucial for accurate and repeatable measurements. The positions in which the devices must be measured are defined by the standards.

The DASY device holder is designed to cope with different positions given in the standard. It has two scales for the device rotation (with respect to the body axis) and the device inclination (with respect to the line between the ear reference points). The rotation center for both scales is the ear reference point (ERP). Thus the device needs no repositioning when changing the angles.

The DASY device holder is constructed of low-loss POM material having the following dielectric parameters: relative permittivity  $\epsilon = 3$  and loss tangent  $\delta = 0.02$ . The amount of dielectric material has been reduced in the closest vicinity of the device, since measurements have suggested that the influence of the clamp on the test results could thus be lowered.



Device Holder

#### 4.7. Data Storage and Evaluation

##### ➤ Data Storage

The DASY software stores the assessed data from the data acquisition electronics as raw data (in microvolt readings from the probe sensors), together with all the necessary software parameters for the data evaluation (probe calibration data, liquid parameters and device frequency and modulation data) in measurement files. The post-processing software evaluates the desired unit and format for output each time the data is visualized or exported. This allows verification of the complete software setup even after the measurement and allows correction of erroneous parameter settings. For example, if a measurement has been performed with an incorrect crest factor parameter in the device setup, the parameter can be corrected afterwards and the data can be reevaluated.

The measured data can be visualized or exported in different units or formats, depending on the selected probe type (e.g., [V/m], [A/m], [W/kg]). Some of these units are not available in certain situations or give meaningless results, e.g., a SAR-output in a non-loss media, will always be zero. Raw data can also be exported to perform the evaluation with other software packages.

#### Shenzhen Anbotek Compliance Laboratory Limited



➤ Data Evaluation

The DASY post-processing software (SEMCAD) automatically executes the following procedures to calculate the field units from the microvolt readings at the probe connector. The parameters used in the evaluation are stored in the configuration modules of the software:

- Probe parameters:** - Sensitivity Norm<sub>i</sub>, a<sub>i0</sub>, a<sub>i1</sub>, a<sub>i2</sub>
- Conversion factor ConvF<sub>i</sub>
- Diode compression point dcp<sub>i</sub>
- Device parameters:** - Frequency f
- Crest factor cf
- Media parameters:** - Conductivity σ
- Density ρ

These parameters must be set correctly in the software. They can be found in the component documents or they can be imported into the software from the configuration files issued for the DASY components. In the direct measuring mode of the multi-meter option, the parameters of the actual system setup are used. In the scan visualization and export modes, the parameters stored in the corresponding document files are used.

The first step of the evaluation is a linearization of the filtered input signal to account for the compression characteristics of the detector diode. The compensation depends on the input signal, the diode type and the DC-transmission factor from the diode to the evaluation electronics. If the exciting field is pulsed, the crest factor of the signal must be known to correctly compensate for peak power.

The formula for each channel can be given as:

$$V_i = U_i + U_i^2 \cdot \frac{cf}{dcp_i}$$

- with V<sub>i</sub> = compensated signal of channel i, (i = x, y, z)
- U<sub>i</sub> = input signal of channel i, (i = x, y, z)
- cf = crest factor of exciting field (DASY parameter)
- dcp<sub>i</sub> = diode compression point (DASY parameter)

From the compensated input signals, the primary field data for each channel can be evaluated:

E-field Probes:  $E_i = \sqrt{\frac{V_i}{Norm_i \cdot ConvF}}$

H-field Probes:  $H_i = \sqrt{V_i} \cdot \frac{a_{i0} + a_{i1}f + a_{i2}f^2}{f}$

- with V<sub>i</sub> = compensated signal of channel i, (i = x, y, z)
- Norm<sub>i</sub> = sensor sensitivity of channel i, (i = x, y, z), μV/(V/m)<sup>2</sup> for E-field Probes
- ConvF = sensitivity enhancement in solution
- a<sub>ij</sub> = sensor sensitivity factors for H-field probes



$f$  = carrier frequency [GHz]

$E_i$  = electric field strength of channel  $i$  in V/m

$H_i$  = magnetic field strength of channel  $i$  in A/m

The RSS value of the field components gives the total field strength (Hermitian magnitude):

$$E_{\text{tot}} = \sqrt{E_x^2 + E_y^2 + E_z^2}$$

The primary field data are used to calculate the derived field units.

$$\text{SAR} = E_{\text{tot}}^2 \cdot \frac{\sigma}{\rho \cdot 1000}$$

with SAR = local specific absorption rate in W/kg

$E_{\text{tot}}$  = total field strength in V/m

$\sigma$  = conductivity in [mho/m] or [Siemens/m]

$\rho$  = equivalent tissue density in  $\text{g/cm}^3$

Note that the density is set to 1, to account for actual head tissue density rather than the density of the tissue simulating liquid.





## 5. Test Equipment List

Manufacturer	Name of Equipment	Type/Model	Serial Number	Calibration	
				Last Cal.	Due Date
SPEAG	2450MHz System Validation Kit	D2450V2	910	Jun. 11,2024	Jun. 10,2027
SPEAG	Data Acquisition Electronics	DAE4	387	Sept.06,2023	Sept.05,2024
SPEAG	Dosimetric E-Field Probe	EX3DV4	7396	May 06,2024	May 05,2025
Agilent	ENA Series Network Analyzer	E5071C	MY46317418	Oct.26, 2023	Oct.25, 2024
SPEAG	DAK	DAK-3.5	1226	NCR	NCR
SPEAG	SAM Twin Phantom	QD000P40CD	1802	NCR	NCR
SPEAG	ELI Phantom	QDOVA004AA	2058	NCR	NCR
AR	Amplifier	ZHL-42W	QA1118004	NCR	NCR
Agilent	Power Meter	N1914A	MY50001102	Oct.26, 2023	Oct.25, 2024
Agilent	Power Sensor	E9323A	US40410647	Jan. 23, 2024	Jan. 22, 2025
Agilent	Power Sensor	E9323A	MY53100007	Jan. 23, 2024	Jan. 22, 2025
CDKMV	Attenuator	6610	6610-1	Oct.20, 2023	Oct.19, 2024
CDKMV	Attenuator	6606	6606-1	Oct.20, 2023	Oct.19, 2024
Agilent	Spectrum Analyzer	N9020A	MY51170037	Oct.26, 2023	Oct.25, 2024
Agilent	Signal Generation	N5182A	MY48180656	Oct.26, 2023	Oct.25, 2024
Worken	Directional Coupler	0110A056010-10	COM5BNW1A2	Oct.26, 2023	Oct.25, 2024

### Note:

1. The calibration certificate of DASY can be referred to appendix C of this report.
2. The dipole calibration interval can be extended to 3 years with justification. The dipoles are also not physically damaged, or repaired during the interval.
3. The Insertion Loss calibration of Dual Directional Coupler and Attenuator were characterized via the network analyzer and compensated during system check.
4. The dielectric probe kit was calibrated via the network analyzer, with the specified procedure (calibrated in pure water) and calibration kit (standard) short circuit, before the dielectric measurement. The specific procedure and calibration kit are provided by Agilent.
5. In system check we need to monitor the level on the power meter, and adjust the power amplifier level to have precise power level to the dipole; the measured SAR will be normalized to 1W input power according to the ratio of 1W to the input power to the dipole. For system check, the calibration of the power amplifier is deemed not critically required for correct measurement; the power meter is critical and we do have calibration for it.



## 6. Tissue Simulating Liquids

For the measurement of the field distribution inside the SAM phantom with DASY, the phantom must be filled with around 25 liters of homogeneous body tissue simulating liquid. For head SAR testing, the liquid height from the ear reference point (ERP) of the phantom to the liquid top surface is larger than 15 cm, which is shown in Fig. 6.1. For body SAR testing, the liquid height from the center of the flat phantom to the liquid top surface is larger than 15 cm, which is shown as followed:



**Photo of Liquid Height for Head SAR**

The following table gives the recipes for tissue simulating liquid.

Frequency (MHz)	Water (%)	Sugar (%)	Cellulose (%)	Salt (%)	Preventol (%)	DGBE (%)	Conductivity ( $\sigma$ )	Permittivity ( $\epsilon_r$ )
<b>For Head</b>								
2450	55.0	0	0	0.3	0	44.7	1.80	39.2

The following table shows the measuring results for simulating liquid.

Measured Frequency (MHz)	Target Tissue		Measured Tissue			Liquid Temp.	Test Data	
	$\epsilon_r$	$\sigma$	$\epsilon_r$	Dev. (%)	$\sigma$			
2450	39.2	1.80	39.08	-0.31	1.85	2.78	22.7	08/16/2024



## 7. System Verification Procedures

Each DASY system is equipped with one or more system validation kits. These units, together with the predefined measurement procedures within the DASY software, enable the user to conduct the system performance check and system validation. System validation kit includes a dipole, tripod holder to fix it underneath the flat phantom and a corresponding distance holder.

### ➤ Purpose of System Performance check

The system performance check verifies that the system operates within its specifications. System and operator errors can be detected and corrected. It is recommended that the system performance check be performed prior to any usage of the system in order to guarantee reproducible results. The system performance check uses normal SAR measurements in a simplified setup with a well characterized source. This setup was selected to give a high sensitivity to all parameters that might fail or vary over time. The system check does not intend to replace the calibration of the components, but indicates situations where the system uncertainty is exceeded due to drift or failure.

### ➤ System Setup

In the simplified setup for system evaluation, the EUT is replaced by a calibrated dipole and the power source is replaced by a continuous wave that comes from a signal generator. The calibrated dipole must be placed beneath the flat phantom section of the SAM twin phantom with the correct distance holder. The distance holder should touch the phantom surface with a light pressure at the reference marking and be oriented parallel to the long side of the phantom. The equipment setup is shown below:

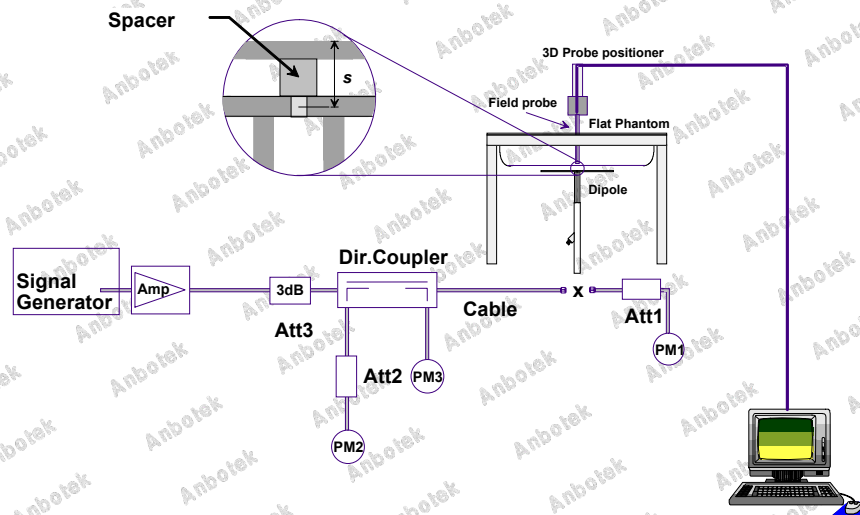

**System Setup for System Evaluation**





**Photo of Dipole Setup**

➤ **Validation Results**

Comparing to the original SAR value provided by SPEAG, the verification data should be within its specification of 10%. The table below shows the target SAR and measured SAR after normalized to 1W input power. It indicates that the system performance check can meet the variation criterion and the plots can be referred to Appendix A of this report.

Date	Frequency (MHz)	Power fed onto reference dipole (mW)	Targeted SAR (W/kg)	Measured SAR (W/kg)	Normalized SAR (W/kg)	Deviation (%)
08/16/2024	2450	250	52.4	12.95	51.8	-1.15

**Target and Measurement SAR after Normalized**



## 8. EUT Testing Position

### 8.1. Body Position

Body-worn operating configurations are tested with the belt-clips and holsters attached to the device and positioned against a flat phantom in a normal use configuration. Per KDB 648474 D04, body-worn accessory exposure is typically related to voice mode operations when handsets are carried in body-worn accessories. The body-worn accessory procedures in FCC KDB 447498 D01 v06, 2015 should be used to test for body-worn accessory SAR compliance, without a headset connected to it. This enables the test results for such configuration to be compatible with that required for hotspot mode when the body-worn accessory test separation distance is greater than or equal to that required for hotspot mode, when applicable. When the reported SAR for body-worn accessory, measured without a headset connected to the handset is  $< 1.2 \text{ W/kg}$ , the highest reported SAR configuration for that wireless mode and frequency band should be repeated for that body-worn accessory with a handset attached to the handset.

Accessories for body-worn operation configurations are divided into two categories: those that do not contain metallic components and those that do contain metallic components and those that do contain metallic components. When multiple accessories that do not contain metallic components are supplied with the device, the device is tested with only the accessory that dictates the closest spacing to the body. Then multiple accessories that contain metallic components are test with the device with each accessory. If multiple accessories share an identical metallic component (i.e. the same metallic belt-chip used with different holsters with no other metallic components) only the accessory that dictates the closest spacing to the body is tested.

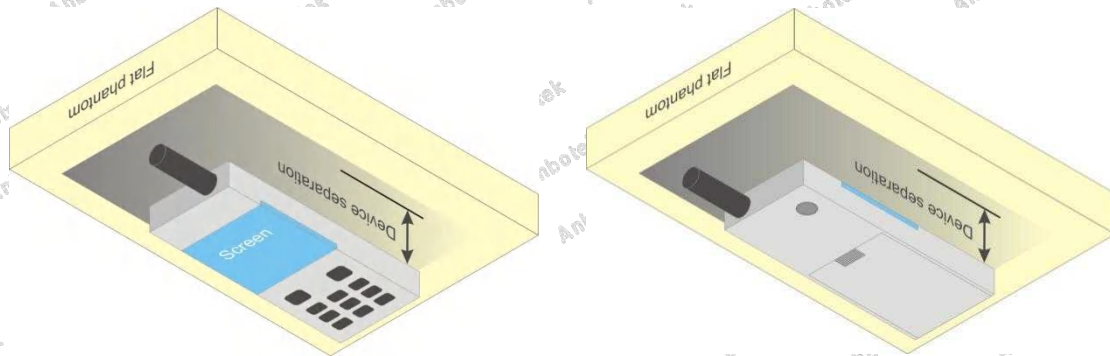

Body Worn Position



## 9. Measurement Procedures

The measurement procedures are as follows:

- (a) Use base station simulator (if applicable) or engineering software to transmit RF power continuously (continuous Tx) in the middle channel.
- (b) Keep EUT to radiate maximum output power or 100% duty factor (if applicable)
- (c) Measure output power through RF cable and power meter.
- (d) Place the EUT in the positions as setup photos demonstrates.
- (e) Set scan area, grid size and other setting on the DASY software.
- (f) Measure SAR transmitting at the middle channel for all applicable exposure positions.
- (g) Identify the exposure position and device configuration resulting the highest SAR
- (h) Measure SAR at the lowest and highest channels at the worst exposure position and device configuration if applicable.

According to the test standard, the recommended procedure for assessing the peak spatial-average SAR value consists of the following steps:

- (a) Power reference measurement
- (b) Area scan
- (c) Zoom scan
- (d) Power drift measurement

### 9.1. Spatial Peak SAR Evaluation

The procedure for spatial peak SAR evaluation has been implemented according to the test standard. It can be conducted for 1g and 10g, as well as for user-specific masses. The DASY software includes all numerical procedures necessary to evaluate the spatial peak SAR value.

The base for the evaluation is a "cube" measurement. The measured volume must include the 1g and 10g cubes with the highest averaged SAR values. For that purpose, the center of the measured volume is aligned to the interpolated peak SAR value of a previously performed area scan.

The entire evaluation of the spatial peak values is performed within the post-processing engine (SEMCAD). The system always gives the maximum values for the 1g and 10g cubes. The algorithm to find the cube with highest averaged SAR is divided into the following stages:

- (a) Extraction of the measured data (grid and values) from the Zoom Scan
- (b) Calculation of the SAR value at every measurement point based on all stored data (A/D values and measurement parameters)
- (c) Generation of a high-resolution mesh within the measured volume
- (d) Interpolation of all measured values from the measurement grid to the high-resolution grid
- (e) Extrapolation of the entire 3-D field distribution to the phantom surface over the distance from sensor to surface
- (f) Calculation of the averaged SAR within masses of 1g and 10g



**9.2. Power Reference Measurement**

The Power Reference Measurement and Power Drift Measurements are for monitoring the power drift of the device under test in the batch process. The minimum distance of probe sensors to surface determines the closest measurement point to phantom surface. This distance cannot be smaller than the distance of sensor calibration points to probe tip as defined in the probe properties.

**9.3. Area Scan Procedures**

The area scan is used as a fast scan in two dimensions to find the area of high field values, before doing a fine measurement around the hot spot. The sophisticated interpolation routines implemented in DASY software can find the maximum found in the scanned area, within a range of the global maximum. The range (in dB0 is specified in the standards for compliance testing. For example, a 2 dB range is required in IEEE standard 1528 and IEC 62209 standards, whereby 3 dB is a requirement when compliance is assessed in accordance with the ARIB standard (Japan), if only one zoom scan follows the area scan, then only the absolute maximum will be taken as reference. For cases where multiple maximums are detected, the number of zoom scans has to be increased accordingly.

Area scan parameters extracted from FCC KDB 865664 D01 SAR measurement 100 MHz to 6 GHz.

	≤ 3 GHz	> 3 GHz
Maximum distance from closest measurement point (geometric center of probe sensors) to phantom surface	5 ± 1 mm	$\frac{1}{2} \cdot \delta \cdot \ln(2) \pm 0.5$ mm
Maximum probe angle from probe axis to phantom surface normal at the measurement location	30° ± 1°	20° ± 1°
Maximum area scan spatial resolution: $\Delta x_{Area}$ , $\Delta y_{Area}$	≤ 2 GHz: ≤ 15 mm 2 – 3 GHz: ≤ 12 mm	3 – 4 GHz: ≤ 12 mm 4 – 6 GHz: ≤ 10 mm
	When the x or y dimension of the test device, in the measurement plane orientation, is smaller than the above, the measurement resolution must be ≤ the corresponding x or y dimension of the test device with at least one measurement point on the test device.	



## 9.4. Zoom Scan Procedures

Zoom scans are used to assess the peak spatial SAR values within a cubic averaging volume containing 1 gram and 10gram of simulated tissue. The zoom scan measures points (refer to table below) within a cube whose base faces are centered on the maxima found in a preceding area scan job within the same procedure. When the measurement is done, the zoom scan evaluates the averaged SAR for 1 gram and 10 gram and displays these values next to the job's label.

Zoom scan parameters extracted from FCC KDB 865664 D01 SAR measurement 100 MHz to 6 GHz.

			≤ 3 GHz	> 3 GHz
Maximum zoom scan spatial resolution: $\Delta x_{Zoom}, \Delta y_{Zoom}$			$\leq 2$ GHz: $\leq 8$ mm $2 - 3$ GHz: $\leq 5$ mm*	$3 - 4$ GHz: $\leq 5$ mm* $4 - 6$ GHz: $\leq 4$ mm*
Maximum zoom scan spatial resolution, normal to phantom surface	uniform grid: $\Delta z_{Zoom}(n)$		$\leq 5$ mm	$3 - 4$ GHz: $\leq 4$ mm $4 - 5$ GHz: $\leq 3$ mm $5 - 6$ GHz: $\leq 2$ mm
		graded grid	$\Delta z_{Zoom}(1)$ : between 1 <sup>st</sup> two points closest to phantom surface	$\leq 4$ mm
	$\Delta z_{Zoom}(n>1)$ : between subsequent points		$\leq 1.5 \cdot \Delta z_{Zoom}(n-1)$	
Minimum zoom scan volume	x, y, z		$\geq 30$ mm	$3 - 4$ GHz: $\geq 28$ mm $4 - 5$ GHz: $\geq 25$ mm $5 - 6$ GHz: $\geq 22$ mm
Note: $\delta$ is the penetration depth of a plane-wave at normal incidence to the tissue medium; see draft standard IEEE P1528-2011 for details. * When zoom scan is required and the <i>reported</i> SAR from the <i>area scan based 1-g SAR estimation</i> procedures of KDB 447498 is $\leq 1.4$ W/kg, $\leq 8$ mm, $\leq 7$ mm and $\leq 5$ mm zoom scan resolution may be applied, respectively, for 2 GHz to 3 GHz, 3 GHz to 4 GHz and 4 GHz to 6 GHz.				





## 9.5. Volume Scan Procedures

The volume scan is used for assess overlapping SAR distributions for antennas transmitting in different frequency bands. It is equivalent to an oversized zoom scan used in standalone measurements. The measurement volume will be used to enclose all the simultaneous transmitting antennas. For antennas transmitting simultaneously in different frequency bands, the volume scan is measured separately in each frequency band. In order to sum correctly to compute the 1g aggregateSAR, the EUT remain in the same test position for all measurements and all volume scan use the same spatial resolution and grid spacing. When all volume scan were completed, the software, SEMCAD postprocessor can combine and subsequently superpose these measurement data to calculating the multiband SAR.

## 9.6. Power Drift Monitoring

All SAR testing is under the EUT install full charged battery and transmit maximum output power. In DASY measurement software, the power reference measurement and power drift measurement procedures are used for monitoring the power drift of EUT during SAR test. Both these procedures measure the field at a specified reference position before and after the SAR testing. The software will calculate the field difference in dB. If the power drift more than 5%, the SAR will be retested.



## 10. Conducted Power

### <WLAN 2.4GHz Conducted Power>

Mode	Channel	Frequency (MHz)	Conducted Average Output Power(dBm)	Tune-up power(dBm)
802.11b	1	2412	18.87	19.00
	6	2437	<b>19.14</b>	19.50
	11	2462	18.24	18.50
802.11g	1	2412	15.44	15.50
	6	2437	15.71	16.00
	11	2462	16.71	17.00
802.11n20	1	2412	15.70	16.00
	6	2437	15.99	16.50
	11	2462	16.24	16.50
802.11n40	3	2422	14.79	15.00
	6	2437	14.55	15.00
	9	2452	14.83	15.00
802.11ax20	1	2412	14.63	15.00
	6	2437	14.84	15.00
	11	2462	15.85	16.00
802.11ax40	3	2422	14.86	15.00
	6	2437	14.75	15.00
	9	2452	14.97	15.00

#### Note:

1. Per KDB 447498 D01, the 1-g SAR test exclusion thresholds for 100 MHz to 6 GHz at *test separation distances*  $\leq 50$  mm are determined by:

$[(\text{max. power of channel, including tune-up tolerance, mW}) / (\text{min. test separation distance, mm})] \cdot [\sqrt{f(\text{GHz})}] \leq 3.0$  for 1-g SAR, where

f(GHz) is the RF channel transmit frequency in GHz

Power and distance are rounded to the nearest mW and mm before calculation

The result is rounded to one decimal place for comparison

2. Base on the result of note1, RF exposure evaluation of 2.4G WIFI mode is required.

3. Per KDB 248227 D01, choose the highest output power channel to test SAR and determine further SAR exclusion.

4. Per KDB 248227 D01, In the 2.4 GHz band, separate SAR procedures are applied to DSSS and OFDM configurations to simplify DSSS test requirements. SAR is not required for the following 2.4 GHz OFDM conditions:

- 1) When KDB Publication 447498 SAR test exclusion applies to the OFDM configuration.
- 2) When the highest reported SAR for DSSS is adjusted by the ratio of OFDM to DSSS specified maximum output power and the adjusted SAR is  $\leq 1.2$  W/kg.

#### Shenzhen Anbotek Compliance Laboratory Limited

Address: Sogood Industrial Zone Laboratory & 1/F. of Building D, Sogood Science and Technology Park, Sanwei Community, Hangcheng Subdistrict, Bao'an District, Shenzhen, Guangdong, China.

Tel:(86)0755-26066440 Email:service@anbotek.com



Hotline  
400-003-0500  
www.anbotek.com



# 11. Antenna Location

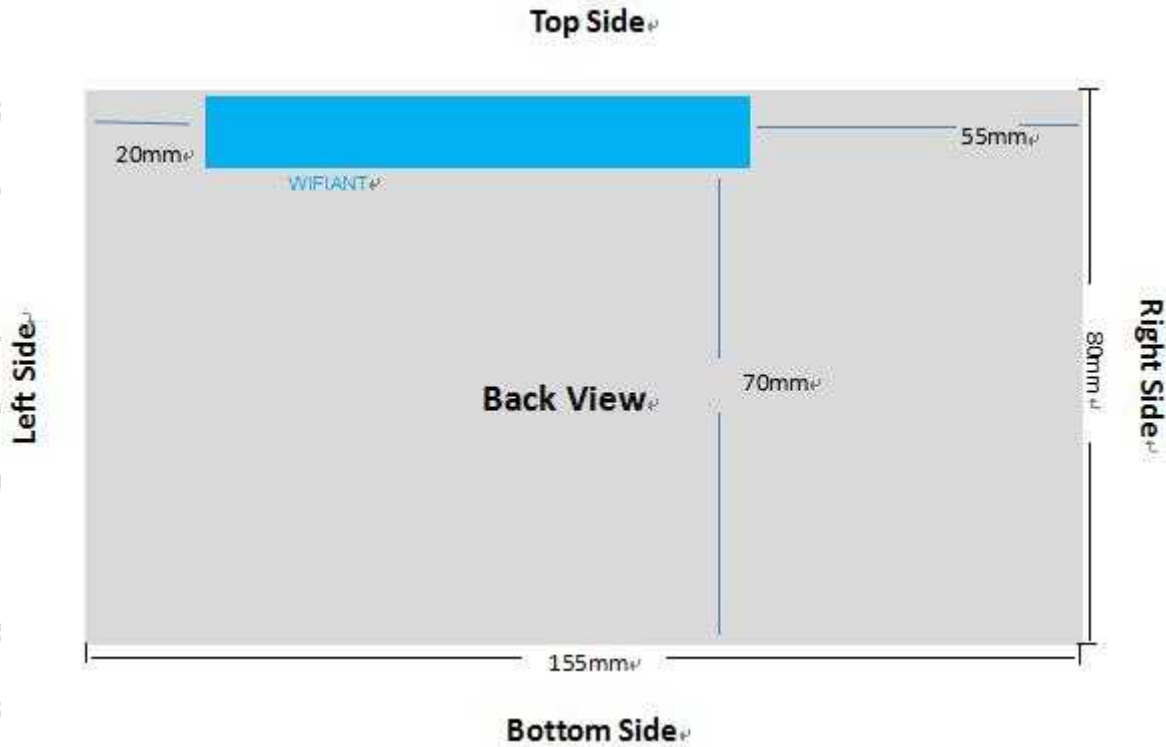

**Distance of The Antenna to the EUT surface and edge**

Antennas	Front	Back	Top Side	Bottom Side	Left Side	Right Side
WIFI ANT	<25mm	<25mm	<25mm	>25mm	<25mm	>25mm

**Positions for SAR tests; Body mode**

Antennas	Front	Back	Top Side	Bottom Side	Left Side	Right Side
WIFI ANT	Yes	Yes	Yes	No	Yes	No

**General Note:** According with FCC KDB 447498 D01, appendix A, <SAR test exclusion thresholds for 100MHz~6GHz and ≤50mm> table, this device SAR test configurations considerations are shown in the table above.

Per KDB 447498 D01, for larger devices, the test separation distance of adjacent edge configuration is determined by the closest separation between the antenna and the user.



## 12. SAR Test Results Summary

### General Note:

1.Per KDB 447498 D01v05r01, the reported SAR is the measured SAR value adjusted for maximum tune-up tolerance.

*Scaling Factor = tune-up limit power (mW) / EUT RF power (mW), where tune-up limit is the maximum rated power among all production units.*

*Reported SAR(W/kg)= Measured SAR(W/kg)\* Scaling Factor*

2.Per KDB 447498 D01v05r01, for each exposure position, if the highest output channel reported  $SAR \leq 0.8W/kg$ , other channels SAR testing are not necessary

3.Per KDB 941225 D05, start with the largest channel bandwidth and measure SAR for QPSK with 1 RB allocation, using the RB offset and required test channel combination with the highest maximum output power for RB offsets at the upper edge, middle and lower edge of each required test channel.

4.Per KDB 941225 D05, 50% RB allocation for QPSK SAR testing follows 1RB QPSK allocation procedure.

5.Per KDB 941225 D05, For QPSK with 100% RB allocation, SAR is not required when the highest maximum output power for 100 % RB allocation is less than the highest maximum output power in 50% and 1 RB allocations and the highest reported SAR for 1 RB and 50% RB allocation are  $\leq 0.8 W/kg$ . Otherwise, SAR is measured for the highest output power channel; and if the reported SAR is  $> 1.45 W/kg$ , the remaining required test channels must also be tested.

6.Per KDB 941225 D05, 16QAM output power for each RB allocation configuration is  $>$  not  $\frac{1}{2}$  dB higher than the same configuration in QPSK and the reported SAR for the QPSK configuration is  $\leq 1.45 W/kg$ ; Per KDB 941225 D05, 16QAM SAR testing is not required.

7.Per KDB 941225 D05, Smaller bandwidth output power for each RB allocation configuration is  $>$  not  $\frac{1}{2}$  dB higher than the same configuration in the largest supported bandwidth, and the reported SAR for the largest supported bandwidth is  $\leq 1.45 W/kg$ ; Per KDB 941225 D05, smaller bandwidth SAR testing is not required.

8.Per KDB865664 D01, for each frequency band, repeated SAR measurement is required only when the measured SAR is  $\geq 0.8W/Kg$ ; if the deviation among the repeated measurement is  $\leq 20\%$ , and the measured SAR  $< 1.45W/Kg$ , only one repeated measurement is required.

9.When the user enables the personal Wireless router functions for the handsets, actual operations include simultaneous transmission of both the Wi-Fi transmitting frequency and thus cannot be evaluated for SAR under actual use conditions. The "Portable Hotspot" feature on the handset was NOT activated, to ensure the SAR measurements were evaluated for a single transmission frequency RF signal.



**12.1. Body-worn SAR Results**

<WIFI>

Plot No.	Band	Antenna Location	Mode	Test Position	Gap (mm)	Ch.	Freq. (MHz)	Average Power (dBm)	Tune-Up Limit (dBm)	Scaling Factor	Power Drift (dB)	Measured SAR <sub>1g</sub> (W/kg)	Reported SAR <sub>1g</sub> (W/kg)
#1	WIFI2.4GHZ	Horizontal	802.11b	Left	0	6	2437	19.14	19.50	1.086	0.01	0.055	0.060
	WIFI2.4GHZ	Horizontal	802.11b	Right	0	6	2437	19.14	19.50	1.086	N/A	N/A	N/A
	WIFI2.4GHZ	Horizontal	802.11b	Top	0	6	2437	19.14	19.50	1.086	0.07	0.366	<b>0.398</b>
	WIFI2.4GHZ	Horizontal	802.11b	Top	0	1	2412	18.87	19.00	1.030	0.05	0.321	0.331
	WIFI2.4GHZ	Horizontal	802.11b	Top	0	11	2462	18.24	18.50	1.062	-0.11	0.269	0.286
	WIFI2.4GHZ	Horizontal	802.11b	Bottom	0	6	2437	19.14	19.50	1.086	N/A	N/A	N/A
	WIFI2.4GHZ	Horizontal	802.11b	Front	0	6	2437	19.14	19.50	1.086	0.13	0.256	0.278
	WIFI2.4GHZ	Horizontal	802.11b	Back	0	6	2437	19.14	19.50	1.086	0.12	0.321	0.349
#2	WIFI2.4GHZ	Bends 90 degrees	802.11b	Left	0	6	2437	19.14	19.50	1.086	0.05	0.048	0.052
	WIFI2.4GHZ	Bends 90 degrees	802.11b	Right	0	6	2437	19.14	19.50	1.086	N/A	N/A	N/A
	WIFI2.4GHZ	Bends 90 degrees	802.11b	Top	0	6	2437	19.14	19.50	1.086	0.01	0.336	<b>0.365</b>
	WIFI2.4GHZ	Bends 90 degrees	802.11b	Top	0	1	2412	18.87	19.00	1.030	0.04	0.297	0.306
	WIFI2.4GHZ	Bends 90 degrees	802.11b	Top	0	11	2462	18.24	18.50	1.062	-0.17	0.233	0.247
	WIFI2.4GHZ	Bends 90 degrees	802.11b	Bottom	0	6	2437	19.14	19.50	1.086	N/A	N/A	N/A
	WIFI2.4GHZ	Bends 90 degrees	802.11b	Front	0	6	2437	19.14	19.50	1.086	0.11	0.241	0.262
	WIFI2.4GHZ	Bends 90 degrees	802.11b	Back	0	6	2437	19.14	19.50	1.086	0.15	0.311	0.338



### 13. Simultaneous Transmission Analysis

#### Simultaneous TX SAR Considerations

No. Applicable Simultaneous Transmission

1. NA



### 14. Measurement Uncertainty

NO	Source	Uncert. ai (%)	Prob. Dist.	Div.	kci (1g)	ci (10g)	Stand.U ncert. ui (1g)	Stand.U ncert. ui (10g)	Veff
1	Repeat	0.4	N	1	1	1	0.4	0.4	9
<b>Instrument</b>									
2	Probe calibration	7	N	2	1	1	3.5	3.5	∞
3	Axial isotropy	4.7	R	$\sqrt{3}$	0.7	0.7	1.9	1.9	∞
4	Hemispherical isotropy	9.4	R	$\sqrt{3}$	0.7	0.7	3.9	3.9	∞
5	Boundary effect	1.0	R	$\sqrt{3}$	1	1	0.6	0.6	∞
6	Linearity	4.7	R	$\sqrt{3}$	1	1	2.7	2.7	∞
7	Detection limits	1.0	R	$\sqrt{3}$	1	1	0.6	0.6	∞
8	Readout electronics	0.3	N	1	1	1	0.3	0.3	∞
9	Response time	0.8	R	$\sqrt{3}$	1	1	0.5	0.5	∞
10	Integration time	2.6	R	$\sqrt{3}$	1	1	1.5	1.5	∞
11	Ambient noise	3.0	R	$\sqrt{3}$	1	1	1.7	1.7	∞
12	Ambient reflections	3.0	R	$\sqrt{3}$	1	1	1.7	1.7	∞
13	Probe positioner mech. restrictions	0.4	R	$\sqrt{3}$	1	1	0.2	0.2	∞
14	Probe positioning with respect to phantom shell	2.9	R	$\sqrt{3}$	1	1	1.7	1.7	∞
15	Max.SAR evaluation	1.0	R	$\sqrt{3}$	1	1	0.6	0.6	∞



Test sample related									
16	Device positioning	3.8	N	1	1	1	3.8	3.8	99
17	Device holder	5.1	N	1	1	1	5.1	5.1	5
18	Drift of output power	5.0	R	$\sqrt{3}$	1	1	2.9	2.9	$\infty$
Phantom and set-up									
19	Phantom uncertainty	4.0	R	$\sqrt{3}$	1	1	2.3	2.3	$\infty$
20	Liquid conductivity (target)	5.0	R	$\sqrt{3}$	0.64	0.43	1.8	1.2	$\infty$
21	Liquid conductivity (meas)	2.5	N	1	0.64	0.43	1.6	1.2	$\infty$
22	Liquid Permittivity (target)	5.0	R	$\sqrt{3}$	0.6	0.49	1.7	1.5	$\infty$
23	Liquid Permittivity (meas)	2.5	N	1	0.6	0.49	1.5	1.2	$\infty$
<b>Combined standard</b>			RSS	$U_c = \sqrt{\sum_{i=1}^n C_i^2 U_i^2}$			11.4%	11.3%	236
<b>Expanded uncertainty(P=95%)</b>			$U_c = k U$ ,k=2				<b>22.8%</b>	<b>22.6%</b>	





## Appendix A. EUT Photos and Test Setup Photos

Please refer to separated files Appendix I -- Test Setup Photograph\_SAR



## Appendix B. Plots of SAR System Check

### 2450MHz Head System Check

Date:08/16/2024

**DUT: Dipole 2450 MHz; Type: D2450V2; Serial: 910**

Communication System: CW; Frequency: 2450 MHz;Duty Cycle: 1:1

Medium parameters used (interpolated):  $f = 2450$  MHz;  $\sigma = 1.85$ S/m;  $\epsilon_r = 39.08$ ;  $\rho = 1000$  kg/m<sup>3</sup>

Phantom section: Flat Section

#### DASY5 Configuration:

Probe: EX3DV4 - SN7396; ConvF(7.57, 7.57, 7.57); Calibrated: May 06, 2024;

Sensor-Surface: 3mm (Mechanical Surface Detection)

Electronics: DAE4 Sn387; Calibrated: Sep.06.2023;

Phantom: SAM 1; Type: SAM;

Measurement SW: DASY52, Version 52.8 (1); SEMCAD X Version 14.6.5 (6469)

**Area Scan (61x91x1):**Measurement grid: dx=10.00 mm, dy=10.00 mm

Maximum value of SAR (interpolated) = 19.664 W/kg

**Zoom Scan (7x7x7)/Cube 0:** Measurement grid: dx=5mm, dy=5mm, dz=5mm

Reference Value = 84.571 V/m; Power Drift = 0.05 dB

Peak SAR (extrapolated) = 26.125 W/kg

**SAR(1 g) = 12.95 W/kg; SAR(10 g) = 5.92 W/kg**

Maximum value of SAR (measured) = 19.47W/kg

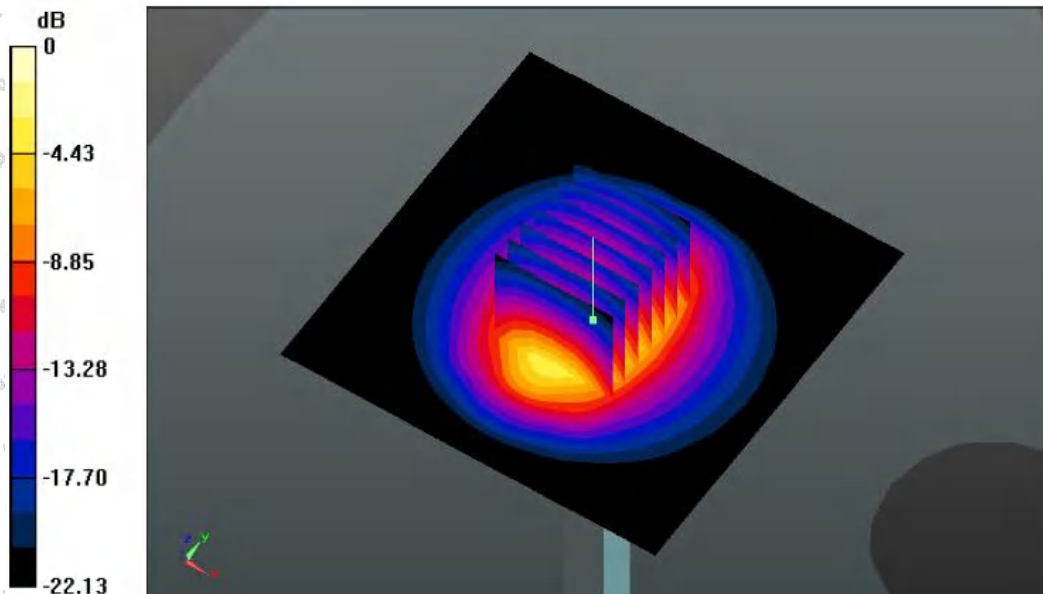

### Shenzhen Anbotek Compliance Laboratory Limited

Address: Sogood Industrial Zone Laboratory & 1/F. of Building D, Sogood Science and Technology Park,  
Sanwei Community, Hangcheng Subdistrict, Bao'an District, Shenzhen, Guangdong, China.

Tel:(86)0755-26066440 Email:service@anbotek.com

Hotline  
400-003-0500  
www.anbotek.com

## Appendix C. Plots of SAR Test Data

#1

Date: 08/16/2024

### WIFI 2.4G\_802.11g\_Body Top \_Ch6

Communication System: UID 0, wifi (fcc) (0); Frequency: 2437 MHz; Duty Cycle: 1:1

Medium parameters used (interpolated):  $f = 2437$  MHz;  $\sigma = 1.85$  S/m;  $\epsilon_r = 39.08$ ;  $\rho = 1000$  kg/m<sup>3</sup>

Phantom section: Flat Section

DASY5 Configuration:

- Probe: EX3DV4 - SN7396; ConvF(7.57, 7.57, 7.57); Calibrated: May 06.2024;
- Sensor-Surface: 4mm (Mechanical Surface Detection)
- Electronics: DAE4 Sn387; Calibrated: Sep.06,2023
- Phantom: SAM 1; Type: SAM;
- Measurement SW: DASY52, Version 52.8 (2); SEMCAD X Version 14.6.10 (7164)

**BODY/Top /Area Scan (91x161x1):** Measurement grid: dx=1.200mm, dy=1.200mm

Maximum value of SAR (measured) = 1.654 W/kg

**BODY/Top /Zoom Scan (7x7x7)/Cube 0:** Measurement grid: dx=5mm, dy=5mm, dz=5mm

Reference Value = 5.528 V/m; Power Drift = 0.07 dB

Peak SAR (extrapolated) = 0.624 W/kg

**SAR(1 g) = 0.366 W/kg; SAR(10 g) = 0.196 W/kg**

Maximum value of SAR (measured) = 0.453 W/kg

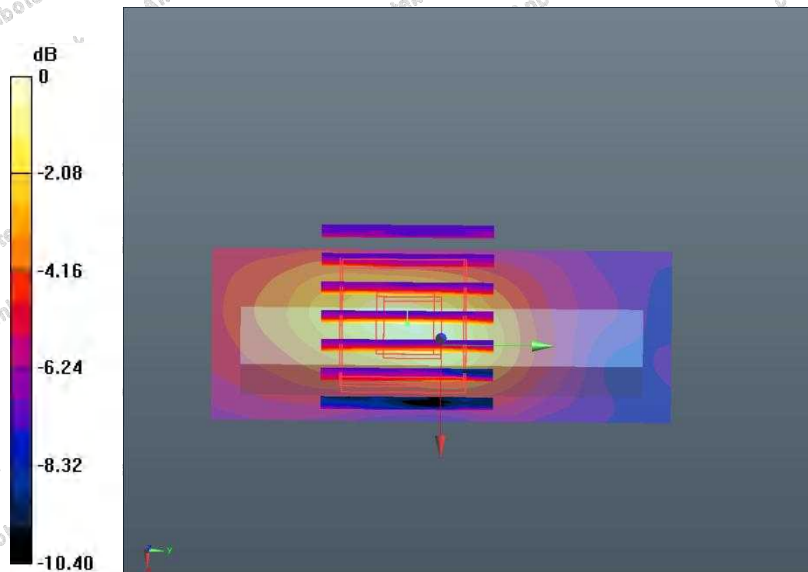

#2

Date: 08/16/2024

**WIFI 2.4G\_802.11g\_Body Top\_Ch6**

Communication System: UID 0, wifi (fcc) (0); Frequency: 2437 MHz; Duty Cycle: 1:1

Medium parameters used (interpolated):  $f = 2437$  MHz;  $\sigma = 1.85$  S/m;  $\epsilon_r = 39.08$ ;  $\rho = 1000$  kg/m<sup>3</sup>

Phantom section: Flat Section

DASY5 Configuration:

- Probe: EX3DV4 - SN7396; ConvF(7.57, 7.57, 7.57); Calibrated: May 06.2024;
- Sensor-Surface: 4mm (Mechanical Surface Detection)
- Electronics: DAE4 Sn387; Calibrated: Sep.06,2023
- Phantom: SAM 1; Type: SAM;
- Measurement SW: DASY52, Version 52.8 (2); SEMCAD X Version 14.6.10 (7164)

**BODY/Top /Area Scan (91x161x1):** Measurement grid: dx=1.200mm, dy=1.200mm

Maximum value of SAR (measured) = 1.412 W/kg

**BODY/Top /Zoom Scan (7x7x7)/Cube 0:** Measurement grid: dx=5mm, dy=5mm, dz=5mm

Reference Value = 5.357 V/m; Power Drift = 0.01 dB

Peak SAR (extrapolated) = 0.465 W/kg

**SAR(1 g) = 0.336 W/kg; SAR(10 g) = 0.171 W/kg**

Maximum value of SAR (measured) = 0.421 W/kg

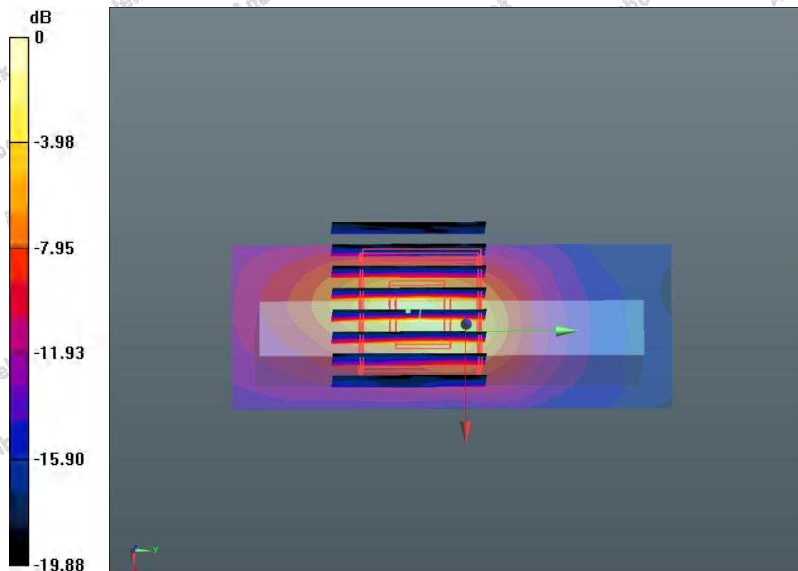

## Appendix A. DASY System Calibration Certificate

Schmid & Partner Engineering AG

**s p e a g**

Zeughausstrasse 43, 8004 Zurich, Switzerland  
Phone +41 44 245 9700, Fax +41 44 245 9779  
info@speag.com, http://www.speag.com

### IMPORTANT NOTICE

#### USAGE OF THE DAE 4

The DAE unit is a delicate, high precision instrument and requires careful treatment by the user. There are no serviceable parts inside the DAE. Special attention shall be given to the following points:

**Battery Exchange:** The battery cover of the DAE4 unit is closed using a screw, over tightening the screw may cause the threads inside the DAE to wear out.

**Shipping of the DAE:** Before shipping the DAE to SPEAG for calibration, remove the batteries and pack the DAE in an antistatic bag. This antistatic bag shall then be packed into a larger box or container which protects the DAE from impacts during transportation. The package shall be marked to indicate that a fragile instrument is inside.

**E-Stop Failures:** Touch detection may be malfunctioning due to broken magnets in the E-stop. Rough handling of the E-stop may lead to damage of these magnets. Touch and collision errors are often caused by dust and dirt accumulated in the E-stop. To prevent E-stop failure, the customer shall always mount the probe to the DAE carefully and keep the DAE unit in a non-dusty environment if not used for measurements.

**Repair:** Minor repairs are performed at no extra cost during the annual calibration. However, SPEAG reserves the right to charge for any repair especially if rough unprofessional handling caused the defect.

**DASY Configuration Files:** Since the exact values of the DAE input resistances, as measured during the calibration procedure of a DAE unit, are not used by the DASY software, a nominal value of 200 MOhm is given in the corresponding configuration file.

**Important Note:**

**Warranty and calibration is void if the DAE unit is disassembled partly or fully by the Customer.**

**Important Note:**

**Never attempt to grease or oil the E-stop assembly. Cleaning and readjusting of the E-stop assembly is allowed by certified SPEAG personnel only and is part of the annual calibration procedure.**

**Important Note:**

**To prevent damage of the DAE probe connector pins, use great care when installing the probe to the DAE. Carefully connect the probe with the connector notch oriented in the mating position. Avoid any rotational movement of the probe body versus the DAE while turning the locking nut of the connector. The same care shall be used when disconnecting the probe from the DAE.**

Schmid & Partner Engineering

TN\_BR040315AD DAE4.doc

11.12.2009



**Calibration Laboratory of**  
**Schmid & Partner**  
**Engineering AG**  
Zeughausstrasse 43, 8004 Zurich, Switzerland



**S** Schweizerischer Kalibrierdienst  
**C** Service suisse d'étalonnage  
**S** Servizio svizzero di taratura  
**S** Swiss Calibration Service

Accredited by the Swiss Accreditation Service (SAS)  
The Swiss Accreditation Service is one of the signatories to the EA  
Multilateral Agreement for the recognition of calibration certificates

Accreditation No.: **SCS 0108**

Client **Anbotek (Auden)**

Certificate No: **DAE4-387\_Sep10**

## CALIBRATION CERTIFICATE

Object **DAE4 - SD 000 D04 BM - SN: 387**

Calibration procedure(s) **QA CAL-06.v29**  
**Calibration procedure for the data acquisition electronics (DAE)**

Calibration date: **September 06, 2023**

This calibration certificate documents the traceability to national standards, which realize the physical units of measurements (SI).  
The measurements and the uncertainties with confidence probability are given on the following pages and are part of the certificate.

All calibrations have been conducted in the closed laboratory facility: environment temperature  $(22 \pm 3)^{\circ}\text{C}$  and humidity  $< 70\%$ .

Calibration Equipment used (M&TE critical for calibration)

Primary Standards	ID #	Cal Date (Certificate No.)	Scheduled Calibration
Keithley Multimeter Type 2001	SN: 0810278	15-Aug-23 (No:22092)	Aug-22
Secondary Standards	ID #	Check Date (in house)	Scheduled Check
Auto DAE Calibration Unit	SE UWS 053 AA 1001	05-Jan-23 (in house check)	In house check: Jan-23
Calibrator Box V2.1	SE UMS 006 AA 1002	05-Jan-23 (in house check)	In house check: Jan-23

Calibrated by: **Dominique Steffen**      **Laboratory Technician**

Approved by: **Sven Kühn**      **Deputy Manager**

Issued: September 06, 2023

This calibration certificate shall not be reproduced except in full without written approval of the laboratory.



**Calibration Laboratory of  
Schmid & Partner  
Engineering AG**  
Zeughausstrasse 43, 8004 Zurich, Switzerland



**S** Schweizerischer Kalibrierdienst  
**S** Service suisse d'étalonnage  
**S** Servizio svizzero di taratura  
**S** Swiss Calibration Service

Accredited by the Swiss Accreditation Service (SAS)  
The Swiss Accreditation Service is one of the signatories to the EA  
Multilateral Agreement for the recognition of calibration certificates

Accreditation No.: **SCS 0108**

**Glossary**

DAE data acquisition electronics  
Connector angle information used in DASY system to align probe sensor X to the robot coordinate system.

**Methods Applied and Interpretation of Parameters**

- *DC Voltage Measurement:* Calibration Factor assessed for use in DASY system by comparison with a calibrated instrument traceable to national standards. The figure given corresponds to the full scale range of the voltmeter in the respective range.
- *Connector angle:* The angle of the connector is assessed measuring the angle mechanically by a tool inserted. Uncertainty is not required.
- The following parameters as documented in the Appendix contain technical information as a result from the performance test and require no uncertainty.
  - *DC Voltage Measurement Linearity:* Verification of the Linearity at +10% and -10% of the nominal calibration voltage. Influence of offset voltage is included in this measurement.
  - *Common mode sensitivity:* Influence of a positive or negative common mode voltage on the differential measurement.
  - *Channel separation:* Influence of a voltage on the neighbor channels not subject to an input voltage.
  - *AD Converter Values with inputs shorted:* Values on the internal AD converter corresponding to zero input voltage
  - *Input Offset Measurement:* Output voltage and statistical results over a large number of zero voltage measurements.
  - *Input Offset Current:* Typical value for information; Maximum channel input offset current, not considering the input resistance.
  - *Input resistance:* Typical value for information: DAE input resistance at the connector, during internal auto-zeroing and during measurement.
  - *Low Battery Alarm Voltage:* Typical value for information. Below this voltage, a battery alarm signal is generated.
  - *Power consumption:* Typical value for information. Supply currents in various operating modes.



**DC Voltage Measurement**

A/D - Converter Resolution nominal

High Range: 1LSB = 6.1μV , full range = -100...+300 mV  
Low Range: 1LSB = 61nV , full range = -1.....+3mV

DASY measurement parameters: Auto Zero Time: 3 sec; Measuring time: 3 sec

Calibration Factors	X	Y	Z
High Range	404.489 ± 0.02% (k=2)	404.852 ± 0.02% (k=2)	404.862 ± 0.02% (k=2)
Low Range	3.97827 ± 1.50% (k=2)	3.95875 ± 1.50% (k=2)	3.97982 ± 1.50% (k=2)

**Connector Angle**

Connector Angle to be used in DASY system	53.0 ° ± 1 °
---	--------------





**Appendix (Additional assessments outside the scope of SCS0108)**

**1. DC Voltage Linearity**

High Range	Reading ( $\mu\text{V}$ )	Difference ( $\mu\text{V}$ )	Error (%)
Channel X + Input	200032.85	-3.31	-0.00
Channel X + Input	20007.64	1.88	0.01
Channel X - Input	-20003.48	1.18	-0.01
Channel Y + Input	200034.23	-1.43	-0.00
Channel Y + Input	20006.60	0.91	0.00
Channel Y - Input	-20004.04	0.72	-0.00
Channel Z + Input	200035.38	-0.83	-0.00
Channel Z + Input	20003.69	-2.11	-0.01
Channel Z - Input	-20006.38	-1.59	0.01

Low Range	Reading ( $\mu\text{V}$ )	Difference ( $\mu\text{V}$ )	Error (%)
Channel X + Input	2001.63	0.08	0.00
Channel X + Input	202.29	0.70	0.35
Channel X - Input	-197.90	0.60	-0.30
Channel Y + Input	2001.33	-0.07	-0.00
Channel Y + Input	200.86	-0.60	-0.30
Channel Y - Input	-199.87	-1.23	0.62
Channel Z + Input	2001.61	0.27	0.01
Channel Z + Input	200.60	-0.70	-0.35
Channel Z - Input	-199.51	-0.85	0.43

**2. Common mode sensitivity**

DASY measurement parameters: Auto Zero Time: 3 sec; Measuring time: 3 sec

	Common mode Input Voltage (mV)	High Range Average Reading ( $\mu\text{V}$ )	Low Range Average Reading ( $\mu\text{V}$ )
Channel X	200	13.50	11.56
	- 200	-8.64	-11.18
Channel Y	200	-0.81	-1.28
	- 200	1.05	0.09
Channel Z	200	7.17	6.91
	- 200	-9.46	-9.01

**3. Channel separation**

DASY measurement parameters: Auto Zero Time: 3 sec; Measuring time: 3 sec

	Input Voltage (mV)	Channel X ( $\mu\text{V}$ )	Channel Y ( $\mu\text{V}$ )	Channel Z ( $\mu\text{V}$ )
Channel X	200	-	-1.70	0.33
Channel Y	200	10.70	-	-0.38
Channel Z	200	7.11	7.89	-



**4. AD-Converter Values with inputs shorted**

DASY measurement parameters: Auto Zero Time: 3 sec; Measuring time: 3 sec

	High Range (LSB)	Low Range (LSB)
Channel X	15969	17466
Channel Y	15661	16162
Channel Z	15990	16190

**5. Input Offset Measurement**

DASY measurement parameters: Auto Zero Time: 3 sec; Measuring time: 3 sec  
Input 10MΩ

	Average (μV)	min. Offset (μV)	max. Offset (μV)	Std. Deviation (μV)
Channel X	0.73	-2.58	3.29	0.62
Channel Y	0.41	-0.49	1.23	0.40
Channel Z	-0.80	-1.88	0.30	0.42

**6. Input Offset Current**

Nominal Input circuitry offset current on all channels: <25fA

**7. Input Resistance** (Typical values for information)

	Zeroing (kOhm)	Measuring (MOhm)
Channel X	200	200
Channel Y	200	200
Channel Z	200	200

**8. Low Battery Alarm Voltage** (Typical values for information)

Typical values	Alarm Level (VDC)
Supply (+ Vcc)	+7.9
Supply (- Vcc)	-7.6

**9. Power Consumption** (Typical values for information)

Typical values	Switched off (mA)	Stand by (mA)	Transmitting (mA)
Supply (+ Vcc)	+0.01	+6	+14
Supply (- Vcc)	-0.01	-8	-9





In Collaboration with  
**S P E A G**  
CALIBRATION LABORATORY



中国认可  
国际互认  
校准  
CALIBRATION  
CNAS L0570

Add: No.51 Xueyuan Road, Haidian District, Beijing, 100191, China  
Tel: +86-10-62304633-2218 Fax: +86-10-62304633-2209  
E-mail: cctl@chinattl.com Http://www.chinattl.cn

Client **Anbotek (Auden)**

Certificate No: **Z24-98671**

**CALIBRATION CERTIFICATE**

Object **EX3DV4 - SN:7396**  
Calibration Procedure(s) **FF-Z12-006-08**  
**Calibration Procedures for Dosimetric E-field Probes**  
Calibration date: **May06, 2024**

This calibration Certificate documents the traceability to national standards, which realize the physical units of measurements(SI). The measurements and the uncertainties with confidence probability are given on the following pages and are part of the certificate.

All calibrations have been conducted in the closed laboratory facility: environment temperature(22±3)°C and humidity<70%.

Calibration Equipment used (M&TE critical for calibration)

Primary Standards	ID #	Cal Date(Calibrated by, Certificate No.)	Scheduled Calibration
Power Meter NRP2	101919	20-Jun-23 (CTTL, No.J23 X07447)	Jun-23
Power sensor NRP-Z91	101547	20-Jun-23 (CTTL, No.J23 X07447)	Jun-23
Power sensor NRP-Z91	101548	20-Jun-23 (CTTL, No.J23 X07447)	Jun-23
Reference10dBAttenuator	18N50W-10dB	13-Mar-24(CTTL, No.J24X01547)	Mar-24
Reference20dBAttenuator	18N50W-20dB	13-Mar-24(CTTL, No.J24X01548)	Mar-24
Reference Probe EX3DV4	SN 7433	26-Sep-23(SPEAG, No.EX3-7433_Sep22)	Sep-23
DAE4	SN 549	13-Dec-23(SPEAG, No.DAE4-549_Dec22)	Dec -23
Secondary Standards	ID #	Cal Date(Calibrated by, Certificate No.)	Scheduled Calibration
SignalGeneratorMG3700A	6201052605	27-Jun-23 (CTTL, No.J23X04776)	Jun-23
Network Analyzer E5071C	MY46110673	13-Jan-24 (CTTL, No.J24X00285)	Jan -24

	Name	Function	Signature
Calibrated by:	Yu Zongying	SAR Test Engineer	
Reviewed by:	Lin Hao	SAR Test Engineer	
Approved by:	Qi Dianyuan	SAR Project Leader	

Issued: May06, 2024

This calibration certificate shall not be reproduced except in full without written approval of the laboratory.





In Collaboration with  
**s p e a g**  
CALIBRATION LABORATORY

Add: No.51 Xueyuan Road, Haidian District, Beijing, 100191, China  
Tel: +86-10-62304633-2218 Fax: +86-10-62304633-2209  
E-mail: cttl@chinattl.com [Http://www.chinattl.cn](http://www.chinattl.cn)

# Probe EX3DV4

## SN: 7396

Calibrated: May 06, 2024

Calibrated for DASY/EASY Systems

(Note: non-compatible with DASY2 system!)





In Collaboration with  
**TTL s p e a g**  
CALIBRATION LABORATORY

Add: No.51 Xueyuan Road, Haidian District, Beijing, 100191, China  
Tel: +86-10-62304633-2218 Fax: +86-10-62304633-2209  
E-mail: cttl@chinattl.com [Http://www.chinattl.cn](http://www.chinattl.cn)

**DASY/EASY – Parameters of Probe: EX3DV4 – SN: 7396**

**Basic Calibration Parameters**

	Sensor X	Sensor Y	Sensor Z	Unc (k=2)
Norm( $\mu V/(V/m)^2$ ) <sup>A</sup>	0.54	0.53	0.50	$\pm 10.0\%$
DCP(mV) <sup>B</sup>	97.8	104.5	102.5	

**Modulation Calibration Parameters**

UID	Communication System Name		A dB	B dB/ $\mu V$	C	D dB	VR mV	Unc <sup>E</sup> (k=2)
0	CW	X	0.0	0.0	1.0	0.00	199.9	$\pm 2.4\%$
		Y	0.0	0.0	1.0		203.3	
		Z	0.0	0.0	1.0		195.0	

The reported uncertainty of measurement is stated as the standard uncertainty of Measurement multiplied by the coverage factor k=2, which for a normal distribution Corresponds to a coverage probability of approximately 95%.

<sup>A</sup> The uncertainties of Norm X, Y, Z do not affect the E<sup>2</sup>-field uncertainty inside TSL (see Page 5 and Page 6).  
<sup>B</sup> Numerical linearization parameter: uncertainty not required.  
<sup>E</sup> Uncertainty is determined using the max. deviation from linear response applying rectangular distribution and is expressed for the square of the field value.





In Collaboration with  
**s p e a g**  
CALIBRATION LABORATORY

Add: No.51 Xueyuan Road, Haidian District, Beijing, 100191, China  
Tel: +86-10-62304633-2218 Fax: +86-10-62304633-2209  
E-mail: ttl@chinattl.com <http://www.chinattl.cn>

**DASY/EASY – Parameters of Probe: EX3DV4 – SN: 7396**

**Calibration Parameter Determined in Head Tissue Simulating Media**

f [MHz] <sup>C</sup>	Relative Permittivity <sup>F</sup>	Conductivity (S/m) <sup>F</sup>	ConvF X	ConvF Y	ConvF Z	Alpha <sup>G</sup>	Depth <sup>G</sup> (mm)	Unct. (k=2)
750	41.9	0.89	9.82	9.82	9.82	0.30	0.85	±12.1%
835	41.5	0.90	9.71	9.71	9.71	0.15	1.36	±12.1%
900	41.5	0.97	9.87	9.87	9.87	0.18	1.37	+12.1%
1750	40.1	1.37	8.61	8.61	8.61	0.25	1.04	±12.1%
1900	40.0	1.40	8.13	8.13	8.13	0.24	1.01	±12.1%
2100	39.8	1.49	8.14	8.14	8.14	0.24	1.04	+12.1%
2300	39.5	1.67	7.85	7.85	7.85	0.40	0.75	±12.1%
2450	39.2	1.80	7.57	7.57	7.57	0.50	0.75	+12.1%
2600	39.0	1.96	7.38	7.38	7.38	0.64	0.68	±12.1%
5250	35.9	4.71	5.33	5.33	5.33	0.45	1.30	+13.3%
5600	35.5	5.07	4.89	4.89	4.89	0.45	1.35	±13.3%
5750	35.4	5.22	4.92	4.92	4.92	0.45	1.45	±13.3%

<sup>C</sup> Frequency validity above 300 MHz of ±100MHz only applies for DASY v4.4 and higher (Page 2), else it is restricted to ±50MHz. The uncertainty is the RSS of ConvF uncertainty at calibration frequency and the uncertainty for the indicated frequency band. Frequency validity below 300 MHz is ± 10, 25, 40, 50 and 70 MHz for ConvF assessments at 30, 64, 128, 150 and 220 MHz respectively. Above 5 GHz frequency validity can be extended to ± 110 MHz.

<sup>F</sup> At frequency below 3 GHz, the validity of tissue parameters ( $\epsilon$  and  $\sigma$ ) can be relaxed to ±10% if liquid compensation formula is applied to measured SAR values. At frequencies above 3 GHz, the validity of tissue parameters ( $\epsilon$  and  $\sigma$ ) is restricted to ±5%. The uncertainty is the RSS of the ConvF uncertainty for indicated target tissue parameters.

<sup>G</sup> Alpha/Depth are determined during calibration. SPEAG warrants that the remaining deviation due to the boundary effect after compensation is always less than ± 1% for frequencies below 3 GHz and below ± 2% for the frequencies between 3-6 GHz at any distance larger than half the probe tip diameter from the boundary.





In Collaboration with  
**s p e a g**  
CALIBRATION LABORATORY

Add: No.51 Xueyuan Road, Haidian District, Beijing, 100191, China  
Tel: +86-10-62304633-2218 Fax: +86-10-62304633-2209  
E-mail: cttl@chinattl.com Http://www.chinattl.cn

## DASY/EASY – Parameters of Probe: EX3DV4 – SN: 7396

### Calibration Parameter Determined in Body Tissue Simulating Media

f [MHz] <sup>C</sup>	Relative Permittivity <sup>F</sup>	Conductivity (S/m) <sup>F</sup>	ConvF X	ConvF Y	ConvF Z	Alpha <sup>G</sup>	Depth <sup>G</sup> (mm)	Unct. (k=2)
750	55.5	0.96	10.09	10.09	10.09	0.30	0.90	±12.1%
835	55.2	0.97	9.88	9.88	9.88	0.19	1.32	±12.1%
900	55.0	1.05	9.82	9.82	9.82	0.23	1.15	±12.1%
1750	53.4	1.49	8.24	8.24	8.24	0.24	1.06	±12.1%
1900	53.3	1.52	7.97	7.97	7.97	0.19	1.24	±12.1%
2100	53.2	1.62	8.18	8.18	8.18	0.19	1.39	±12.1%
2300	52.9	1.81	7.88	7.88	7.88	0.55	0.80	±12.1%
2450	52.7	1.95	7.53	7.53	7.53	0.46	0.89	±12.1%
2600	52.5	2.16	7.38	7.38	7.38	0.52	0.80	±12.1%
5250	48.9	5.36	4.93	4.93	4.93	0.45	1.80	±13.3%
5800	48.5	5.77	4.19	4.19	4.19	0.48	1.90	±13.3%
5750	48.3	5.94	4.52	4.52	4.52	0.48	1.95	±13.3%

<sup>C</sup> Frequency validity above 300 MHz of ±100MHz only applies for DASY v4.4 and higher (Page 2), else it is restricted to ±50MHz. The uncertainty is the RSS of ConvF uncertainty at calibration frequency and the uncertainty for the indicated frequency band. Frequency validity below 300 MHz is ± 10, 25, 40, 50 and 70 MHz for ConvF assessments at 30, 64, 128, 150 and 220 MHz respectively. Above 5 GHz frequency validity can be extended to ± 110 MHz.

<sup>F</sup> At frequency below 3 GHz, the validity of tissue parameters ( $\epsilon$  and  $\sigma$ ) can be relaxed to ±10% if liquid compensation formula is applied to measured SAR values. At frequencies above 3 GHz, the validity of tissue parameters ( $\epsilon$  and  $\sigma$ ) is restricted to ±5%. The uncertainty is the RSS of the ConvF uncertainty for indicated target tissue parameters.

<sup>G</sup> Alpha/Depth are determined during calibration. SPEAG warrants that the remaining deviation due to the boundary effect after compensation is always less than ± 1% for frequencies below 3 GHz and below ± 2% for the frequencies between 3-6 GHz at any distance larger than half the probe tip diameter from the boundary.



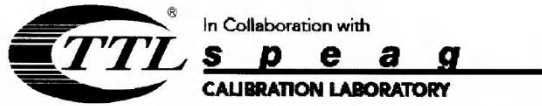

Add: No.51 Xueyuan Road, Haidian District, Beijing, 100191, China  
Tel: +86-10-62304633-2218 Fax: +86-10-62304633-2209  
E-mail: cttl@chinattl.com [Http://www.chinattl.cn](http://www.chinattl.cn)

### Frequency Response of E-Field (TEM-Cell: ifi110 EXX, Waveguide: R22)

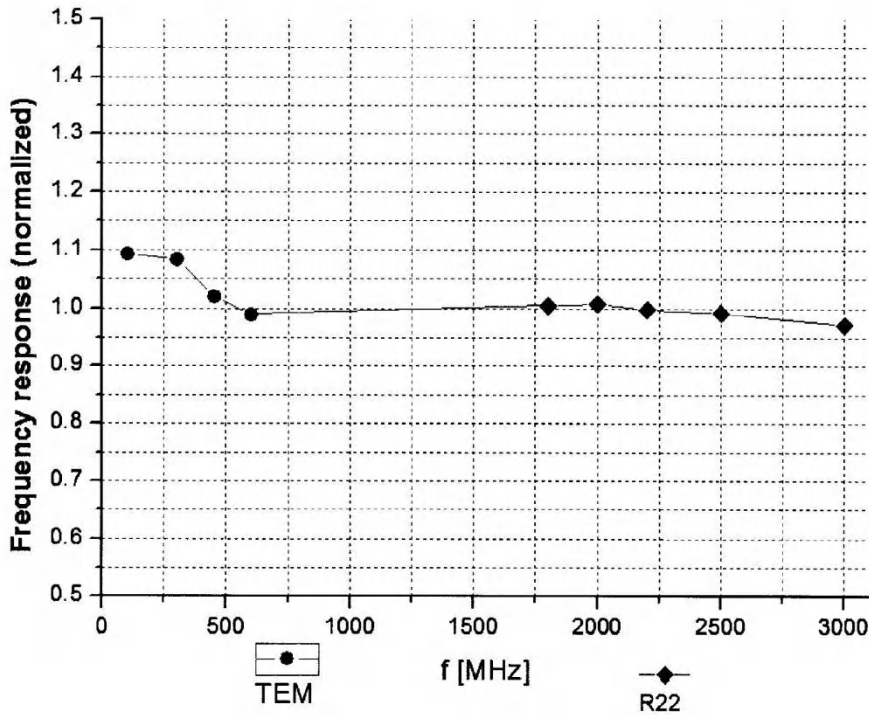

Uncertainty of Frequency Response of E-field:  $\pm 7.4\%$  (k=2)





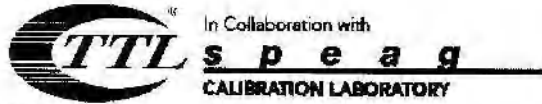

Add: No.51 Xueyuan Road, Haidian District, Beijing, 100191, China  
Tel: 86-10-62304633-2218 Fax: 86-10-62304633-2209  
E-mail: ttl@chinattl.com <http://www.chinattl.cn>

**Receiving Pattern ( $\Phi$ ),  $\theta=0^\circ$**

**f=600 MHz, TEM**

**f=1800 MHz, R22**

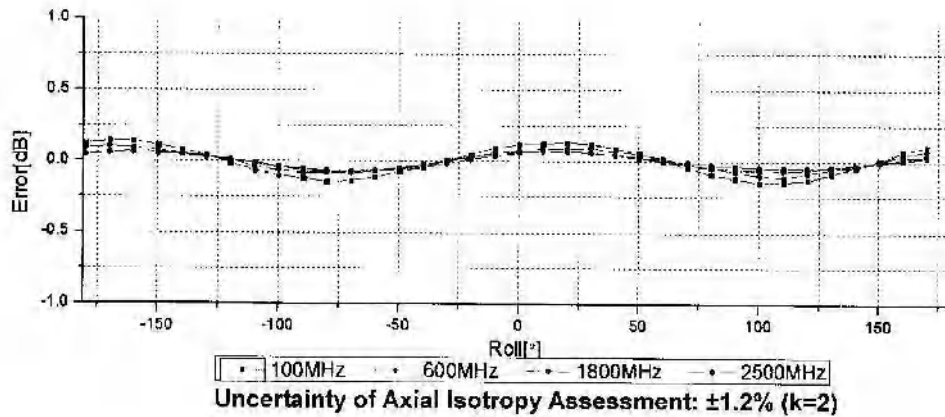
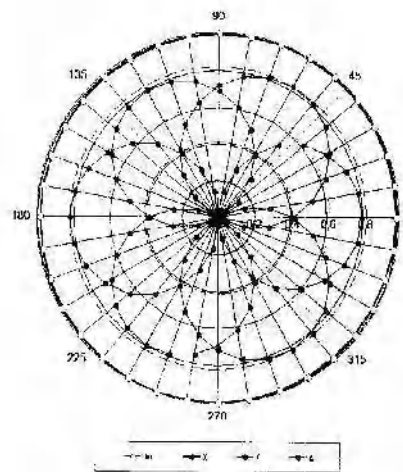
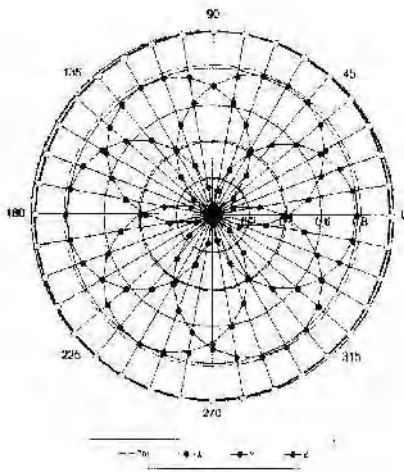



In Collaboration with  
**s p e a g**  
CALIBRATION LABORATORY

Add: No.51 Xueyuan Road, Haidian District, Beijing, 100191, China  
Tel: +86-10-62304633-2218 Fax: +86-10-62304633-2309  
E-mail: cttl@chinattl.com Http://www.chinattl.cn

### Dynamic Range f(SAR<sub>head</sub>) (TEM cell, f = 900 MHz)

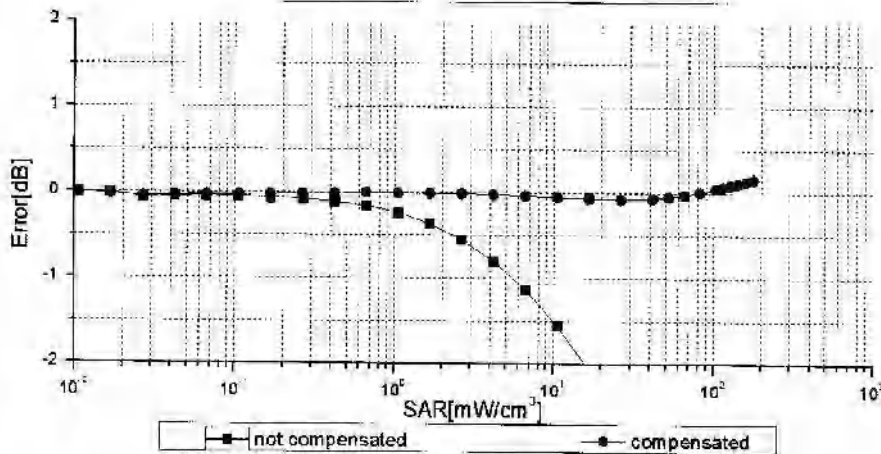
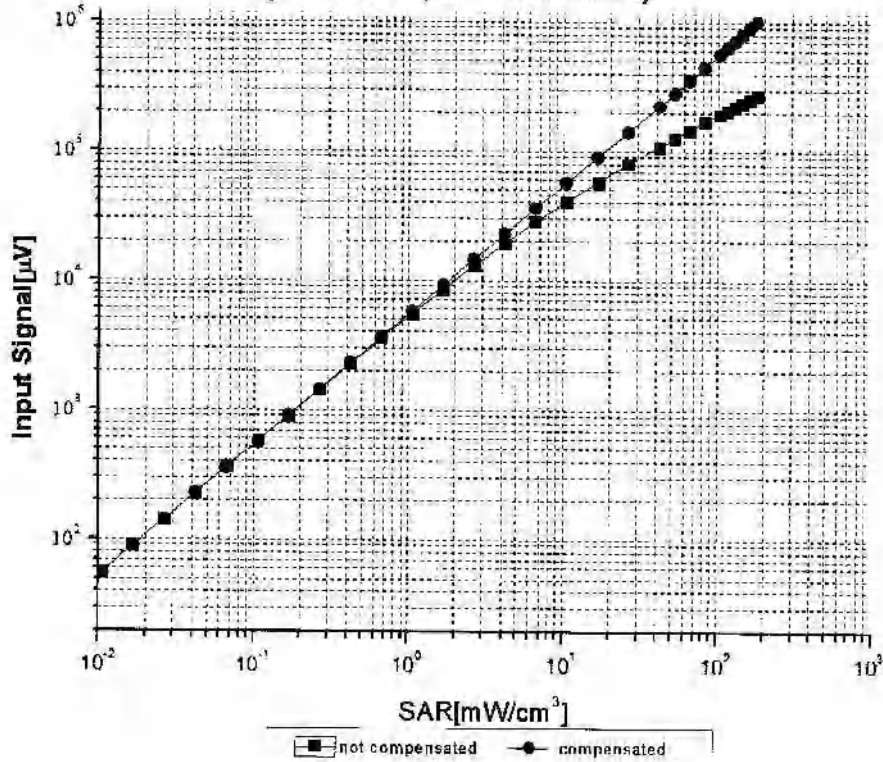

Uncertainty of Linearity Assessment: ±0.9% (k=2)



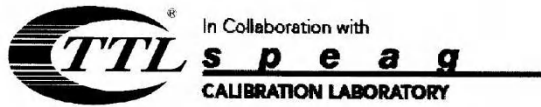

Add: No.51 Xueyuan Road, Haidian District, Beijing, 100191, China  
Tel: +86-10-62304633-2218 Fax: +86-10-62304633-2209  
E-mail: cttl@chinattl.com Http://www.chinattl.cn

## Conversion Factor Assessment

f=900 MHz, WGLS R9(H\_convF)

f=1750 MHz, WGLS R22(H\_convF)

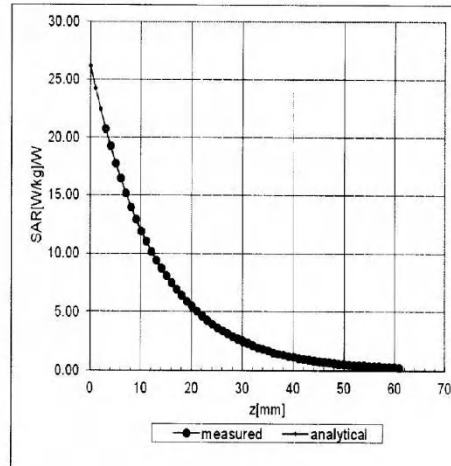
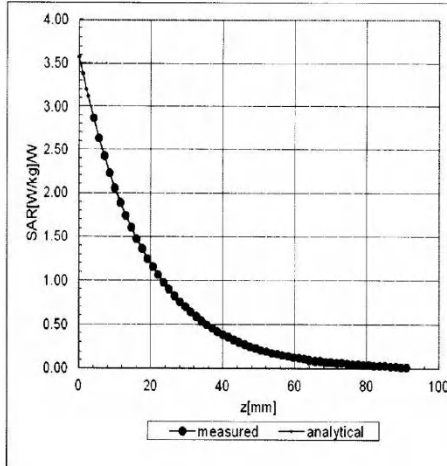

## Deviation from Isotropy in Liquid

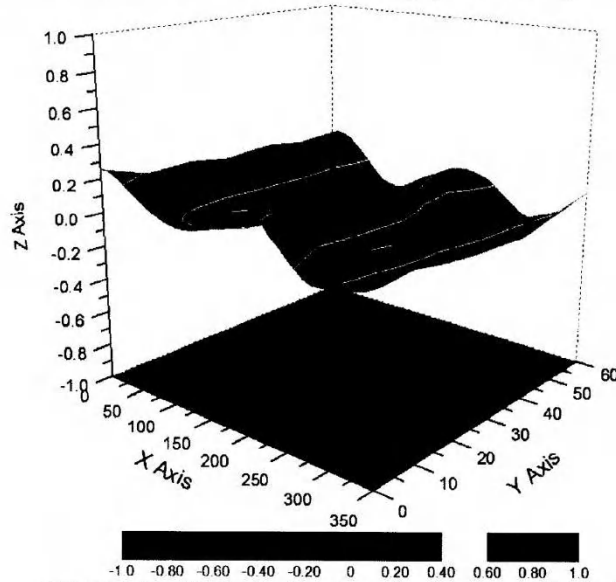

Uncertainty of Spherical Isotropy Assessment:  $\pm 3.2\%$  (K=2)



In Collaboration with  
**s p e a g**  
CALIBRATION LABORATORYAdd: No.51 Xueyuan Road, Haidian District, Beijing, 100191, China  
Tel: +86-10-62304633-2218 Fax: +86-10-62304633-2209  
E-mail: cttl@chinattl.com [Http://www.chinattl.cn](http://www.chinattl.cn)**DASY/EASY – Parameters of Probe: EX3DV4 – SN: 7396****Other Probe Parameters**

<b>Sensor Arrangement</b>	<b>Triangular</b>
<b>Connector Angle (°)</b>	<b>156.9</b>
<b>Mechanical Surface Detection Mode</b>	<b>enabled</b>
<b>Optical Surface Detection Mode</b>	<b>disable</b>
<b>Probe Overall Length</b>	<b>337mm</b>
<b>Probe Body Diameter</b>	<b>10mm</b>
<b>Tip Length</b>	<b>9mm</b>
<b>Tip Diameter</b>	<b>2.5mm</b>
<b>Probe Tip to Sensor X Calibration Point</b>	<b>1mm</b>
<b>Probe Tip to Sensor Y Calibration Point</b>	<b>1mm</b>
<b>Probe Tip to Sensor Z Calibration Point</b>	<b>1mm</b>
<b>Recommended Measurement Distance from Surface</b>	<b>1.4mm</b>



In Collaboration with  
**s p e a g**  
CALIBRATION LABORATORY中国认可  
国际互认  
校准  
CALIBRATION  
CNAS L0570Add: No.51 Xueyuan Road, Haidian District, Beijing, 100191, China  
Tel: +86-10-62304633-2079 Fax: +86-10-62304633-2504  
E-mail: cttl@chinattl.com [Http://www.chinattl.cn](http://www.chinattl.cn)

Client

Anbotek (Auden)

Certificate No:

Z24-97091

**CALIBRATION CERTIFICATE**

Object D2450V2 - SN: 910

Calibration Procedure(s) FD-Z24-2-003-01  
Calibration Procedures for dipole validation kits

Calibration date: Jun 11, 2024

This calibration Certificate documents the traceability to national standards, which realize the physical units of measurements(SI). The measurements and the uncertainties with confidence probability are given on the following pages and are part of the certificate.

All calibrations have been conducted in the closed laboratory facility: environment temperature(22±3)°C and humidity<70%.

Calibration Equipment used (M&amp;TE critical for calibration)

Primary Standards	ID #	Cal Date(Calibrated by, Certificate No.)	Scheduled Calibration
Power Meter NRP2	101919	01-Jul-23 (CTTL, No.J23X04256)	Jun-24
Power sensor NRP-Z91	101547	01-Jul-23 (CTTL, No.J23X04256)	Jun-24
Reference Probe EX3DV4	SN 7307	19-Feb-24(SPEAG,No.EX3-7307_Feb24)	Feb-25
DAE4	SN 771	02-Feb-24(CTTL-SPEAG,No.Z24-97011)	Feb-25
Secondary Standards	ID #	Cal Date(Calibrated by, Certificate No.)	Scheduled Calibration
Signal Generator E4438C	MY49071430	01-Feb-24 (CTTL, No.J24X00893)	Jan-25
Network Analyzer E5071C	MY46110673	26-Jan-24 (CTTL, No.J24X00894)	Jan-25

	Name	Function	Signature
Calibrated by:	Zhao Jing	SAR Test Engineer	
Reviewed by:	Qi Dianyuan	SAR Project Leader	
Approved by:	Lu Bingsong	Deputy Director of the laboratory	

Issued: Jun 12, 2024

This calibration certificate shall not be reproduced except in full without written approval of the laboratory.





In Collaboration with

**s p e a g**  
**CALIBRATION LABORATORY**

Add: No.51 Xueyuan Road, Haidian District, Beijing, 100191, China  
 Tel: +86-10-62304633-2079 Fax: +86-10-62304633-2504  
 E-mail: cttl@chinattl.com Http://www.chinattl.cn

**Glossary:**

TSL	tissue simulating liquid
ConvF	sensitivity in TSL / NORM <sub>x,y,z</sub>
N/A	not applicable or not measured

**Calibration is Performed According to the Following Standards:**

- IEEE Std 1528-2013, "IEEE Recommended Practice for Determining the Peak Spatial-Averaged Specific Absorption Rate (SAR) in the Human Head from Wireless Communications Devices: Measurement Techniques", June 2013
- IEC 62209-1, "Procedure to measure the Specific Absorption Rate (SAR) For hand-held devices used in close proximity to the ear (frequency range of 300MHz to 3GHz)", February 2005
- IEC 62209-2, "Procedure to measure the Specific Absorption Rate (SAR) For wireless communication devices used in close proximity to the human body (frequency range of 30MHz to 6GHz)", March 2010
- KDB865664, SAR Measurement Requirements for 100 MHz to 6 GHz

**Additional Documentation:**

- DASY4/5 System Handbook

**Methods Applied and Interpretation of Parameters:**

- Measurement Conditions:** Further details are available from the Validation Report at the end of the certificate. All figures stated in the certificate are valid at the frequency indicated.
- Antenna Parameters with TSL:** The dipole is mounted with the spacer to position its feed point exactly below the center marking of the flat phantom section, with the arms oriented parallel to the body axis.
- Feed Point Impedance and Return Loss:** These parameters are measured with the dipole positioned under the liquid filled phantom. The impedance stated is transformed from the measurement at the SMA connector to the feed point. The Return Loss ensures low reflected power. No uncertainty required.
- Electrical Delay:** One-way delay between the SMA connector and the antenna feed point. No uncertainty required.
- SAR measured:** SAR measured at the stated antenna input power.
- SAR normalized:** SAR as measured, normalized to an input power of 1 W at the antenna connector.
- SAR for nominal TSL parameters:** The measured TSL parameters are used to calculate the nominal SAR result.

The reported uncertainty of measurement is stated as the standard uncertainty of Measurement multiplied by the coverage factor  $k=2$ , which for a normal distribution Corresponds to a coverage probability of approximately 95%.





In Collaboration with  
**s p e a g**  
CALIBRATION LABORATORY

Add: No.51 Xueyuan Road, Haidian District, Beijing, 100191, China  
Tel: +86-10-62304633-2079 Fax: +86-10-62304633-2504  
E-mail: cttl@chinattl.com Http://www.chinattl.cn

**Measurement Conditions**

DASY system configuration, as far as not given on page 1.

<b>DASY Version</b>	DASY52	52.8.8.1258
<b>Extrapolation</b>	Advanced Extrapolation	
<b>Phantom</b>	Triple Flat Phantom 5.1C	
<b>Distance Dipole Center - TSL</b>	10 mm	with Spacer
<b>Zoom Scan Resolution</b>	dx, dy, dz = 5 mm	
<b>Frequency</b>	2450 MHz ± 1 MHz	

**Head TSL parameters**

The following parameters and calculations were applied.

	Temperature	Permittivity	Conductivity
<b>Nominal Head TSL parameters</b>	22.0 °C	39.2	1.80 mho/m
<b>Measured Head TSL parameters</b>	(22.0 ± 0.2) °C	39.0 ± 6 %	1.77 mho/m ± 6 %
<b>Head TSL temperature change during test</b>	<1.0 °C	----	----

**SAR result with Head TSL**

SAR averaged over 1 cm <sup>3</sup> (1 g) of Head TSL	Condition	
SAR measured	250 mW input power	13.0 mW / g
SAR for nominal Head TSL parameters	normalized to 1W	<b>52.4 mW / g ± 20.8 % (k=2)</b>
SAR averaged over 10 cm <sup>3</sup> (10 g) of Head TSL	Condition	
SAR measured	250 mW input power	6.06 mW / g
SAR for nominal Head TSL parameters	normalized to 1W	<b>24.3 mW / g ± 20.4 % (k=2)</b>

**Body TSL parameters**

The following parameters and calculations were applied.

	Temperature	Permittivity	Conductivity
<b>Nominal Body TSL parameters</b>	22.0 °C	52.7	1.95 mho/m
<b>Measured Body TSL parameters</b>	(22.0 ± 0.2) °C	52.9 ± 6 %	1.97 mho/m ± 6 %
<b>Body TSL temperature change during test</b>	<1.0 °C	----	----

**SAR result with Body TSL**

SAR averaged over 1 cm <sup>3</sup> (1 g) of Body TSL	Condition	
SAR measured	250 mW input power	13.0 mW / g
SAR for nominal Body TSL parameters	normalized to 1W	<b>51.8 mW / g ± 20.8 % (k=2)</b>
SAR averaged over 10 cm <sup>3</sup> (10 g) of Body TSL	Condition	
SAR measured	250 mW input power	6.18 mW / g
SAR for nominal Body TSL parameters	normalized to 1W	<b>24.7 mW / g ± 20.4 % (k=2)</b>



In Collaboration with  
**s p e a g**  
CALIBRATION LABORATORYAdd: No.51 Xueyuan Road, Haidian District, Beijing, 100191, China  
Tel: +86-10-62304633-2079 Fax: +86-10-62304633-2504  
E-mail: cttl@chinattl.com Http://www.chinattl.cn**Appendix****Antenna Parameters with Head TSL**

Impedance, transformed to feed point	54.6Ω+ 2.77jΩ
Return Loss	- 25.8dB

**Antenna Parameters with Body TSL**

Impedance, transformed to feed point	50.7Ω+ 4.28jΩ
Return Loss	- 27.3dB

**General Antenna Parameters and Design**

Electrical Delay (one direction)	1.263 ns
----------------------------------	----------

After long term use with 100W radiated power, only a slight warming of the dipole near the feedpoint can be measured.

The dipole is made of standard semirigid coaxial cable. The center conductor of the feeding line is directly connected to the second arm of the dipole. The antenna is therefore short-circuited for DC-signals. On some of the dipoles, small end caps are added to the dipole arms in order to improve matching when loaded according to the position as explained in the "Measurement Conditions" paragraph. The SAR data are not affected by this change. The overall dipole length is still according to the Standard.  
No excessive force must be applied to the dipole arms, because they might bend or the soldered connections near the feedpoint may be damaged.

**Additional EUT Data**

Manufactured by	SPEAG
-----------------	-------





In Collaboration with  
**s p e a g**  
CALIBRATION LABORATORYAdd: No.51 Xueyuan Road, Haidian District, Beijing, 100191, China  
Tel: +86-10-62304633-2079 Fax: +86-10-62304633-2504  
E-mail: cttl@chinattl.com Http://www.chinattl.cn**DASY5 Validation Report for Head TSL**

Date: 06.11.2024

Test Laboratory: CCTL, Beijing, China

**DUT: Dipole 2450 MHz; Type: D2450V2; Serial: D2450V2 - SN: 910**

Communication System: UID 0, CW; Frequency: 2450 MHz; Duty Cycle: 1:1

Medium parameters used:  $f = 2450$  MHz;  $\sigma = 1.767$  S/m;  $\epsilon_r = 39.01$ ;  $\rho = 1000$  kg/m<sup>3</sup>

Phantom section: Right Section

Measurement Standard: DASY5 (IEEE/IEC/ANSI C63.19-2007)

**DASY5 Configuration:**

- Probe: EX3DV4 - SN7307; ConvF(7.36, 7.36, 7.36); Calibrated: 2/19/2021;
- Sensor-Surface: 2mm (Mechanical Surface Detection)
- Electronics: DAE4 Sn771; Calibrated: 2021-02-02
- Phantom: Triple Flat Phantom 5.1C; Type: QD 000 P51 CA; Serial: 1161/1
- Measurement SW: DASY52, Version 52.8 (8); SEMCAD X Version 14.6.10 (7372)

**Dipole Calibration/Zoom Scan (7x7x7) (7x7x7)/Cube 0:** Measurement grid: dx=5mm, dy=5mm, dz=5mm

Reference Value = 106.5 V/m; Power Drift = 0.02 dB

Peak SAR (extrapolated) = 26.7 W/kg

**SAR(1 g) = 13 W/kg; SAR(10 g) = 6.06 W/kg**

Maximum value of SAR (measured) = 19.7 W/kg

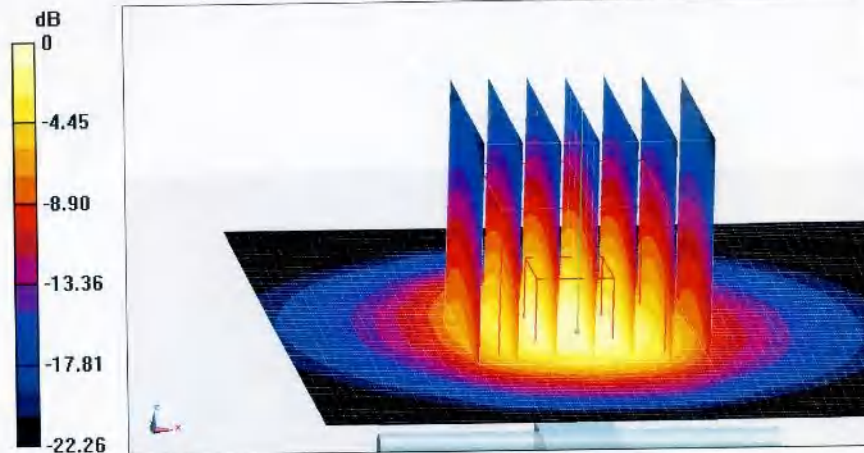
**0 dB = 19.7 W/kg = 12.94 dBW/kg**

Certificate No: Z24-97091

Page 5 of 8





In Collaboration with **s p e a g** CALIBRATION LABORATORY

Add: No.51 Xueyuan Road, Haidian District, Beijing, 100191, China  
Tel: +86-10-62304633-2079 Fax: +86-10-62304633-2504  
E-mail: cttl@chinattl.com Http://www.chinattl.cn

Impedance Measurement Plot for Head TSL

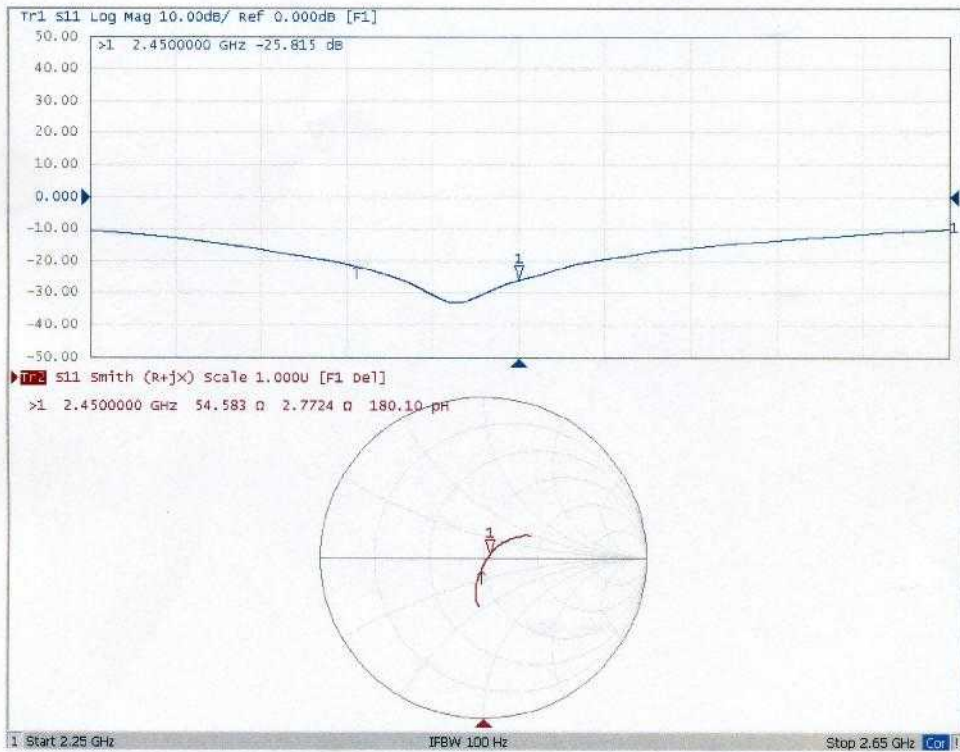

In Collaboration with  
**s p e a g**  
CALIBRATION LABORATORYAdd: No.51 Xueyuan Road, Haidian District, Beijing, 100191, China  
Tel: +86-10-62304633-2079 Fax: +86-10-62304633-2504  
E-mail: [ettl@chinattl.com](mailto:ettl@chinattl.com) [Http://www.chinattl.cn](http://www.chinattl.cn)**DASY5 Validation Report for Body TSL**

Date: 06.11.2024

Test Laboratory: CTTL, Beijing, China

**DUT: Dipole 2450 MHz; Type: D2450V2; Serial: D2450V2 - SN: 910**

Communication System: UID 0, CW; Frequency: 2450 MHz; Duty Cycle: 1:1

Medium parameters used:  $f = 2450$  MHz;  $\sigma = 1.972$  S/m;  $\epsilon_r = 52.92$ ;  $\rho = 1000$  kg/m<sup>3</sup>

Phantom section: Center Section

Measurement Standard: DASY5 (IEEE/IEC/ANSI C63.19-2007)

DASY5 Configuration:

- Probe: EX3DV4 - SN7307; ConvF(7.22, 7.22, 7.22); Calibrated: 2/19/2021;
- Sensor-Surface: 2mm (Mechanical Surface Detection)
- Electronics: DAE4 Sn771; Calibrated: 2021-02-02
- Phantom: Triple Flat Phantom 5.1C; Type: QD 000 P51 CA; Serial: 1161/1
- Measurement SW: DASY52, Version 52.8 (8); SEMCAD X Version 14.6.10 (7372)

**Dipole Calibration/Zoom Scan (7x7x7) (7x7x7)/Cube 0:** Measurement grid: dx=5mm, dy=5mm, dz=5mm

Reference Value = 98.89 V/m; Power Drift = 0.03 dB

Peak SAR (extrapolated) = 25.6 W/kg

**SAR(1 g) = 13 W/kg; SAR(10 g) = 6.18 W/kg**

Maximum value of SAR (measured) = 19.3 W/kg

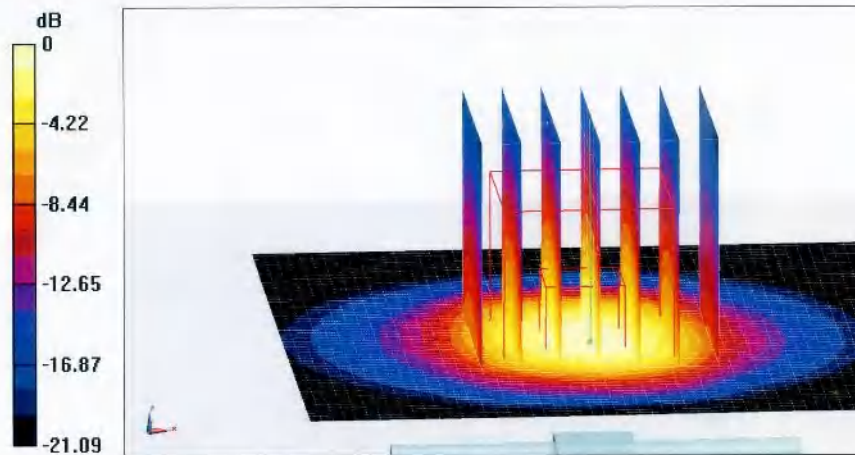

0 dB = 19.3 W/kg = 12.86 dBW/kg





In Collaboration with  
**s p e a g**  
CALIBRATION LABORATORY

Add: No.51 Xueyuan Road, Haidian District, Beijing, 100191, China  
Tel: +86-10-62304633-2079 Fax: +86-10-62304633-2504  
E-mail: cttl@chinattl.com Http://www.chinattl.cn

Impedance Measurement Plot for Body TSL

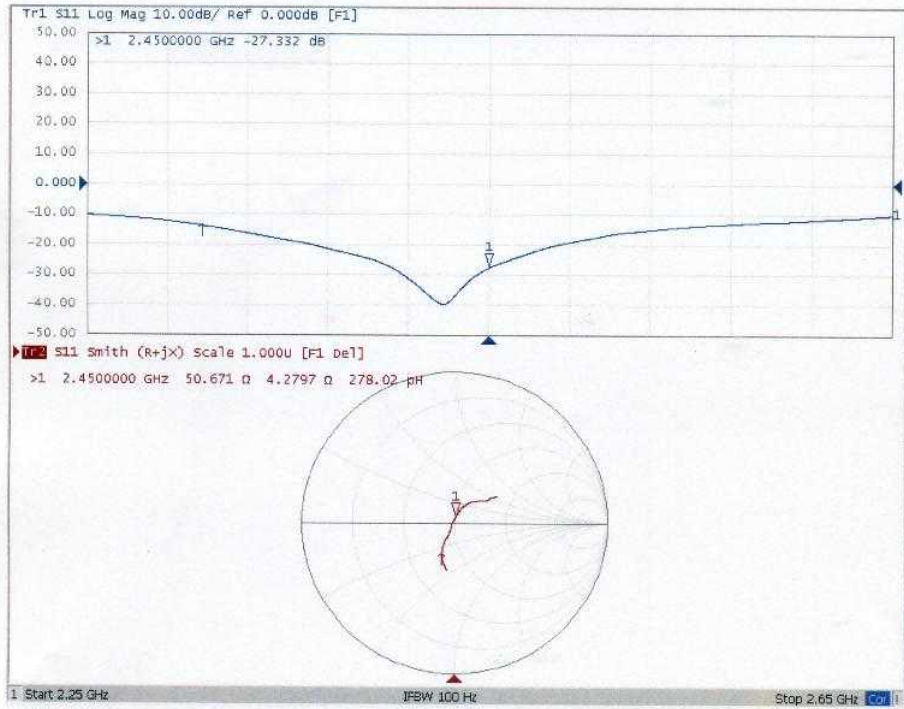

\*\*\*\*\*END OF REPORT\*\*\*\*\*

Shenzhen Anbotek Compliance Laboratory Limited

Address: Sogood Industrial Zone Laboratory & 1/F. of Building D, Sogood Science and Technology Park, Sanwei Community, Hangcheng Subdistrict, Bao'an District, Shenzhen, Guangdong, China.

Tel:(86)0755-26066440 Email:service@anbotek.com

Hotline 400-003-0500  
www.anbotek.com

