

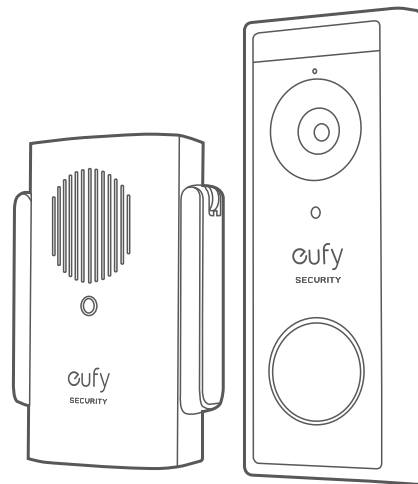

QUICK START GUIDE

Video Doorbell 1080p (Battery-Powered)



Anker Innovations Limited. All rights reserved. **eufy Security** and **eufy Security Logo** are trademarks of Anker Innovations Limited, registered in the United States and other countries. All other trademarks are the property of their respective owners.

51005002289 V01

TABLE OF CONTENTS

What's Included	01	09	Finding a Mounting Spot
Product Overview	03	11	Mounting the Bracket
How the System Works	04	14	Mounting the Doorbell
Powering on the Wi-Fi Doorbell Chime	05	15	Detaching the Doorbell
Setting up the System	07	16	Recharging the Doorbell
Charging Your Doorbell	08	17	Notice

WHAT'S INCLUDED

For Video Doorbell Installation



Video Doorbell 1080p
(Battery-Powered)
Model:T8222

FCC ID: 2AOKB-T8220
IC: 23451-T8220

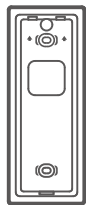

Mounting Bracket



Screw Hole
Positioning Card



15° Mounting
Wedge
(Optional)



USB Charging
Cable

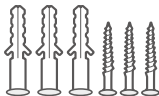

Screw Packs (Spare
screws and anchors are
included)



Doorbell
Detaching Pin



Quick Start
Guide

For Wi-Fi Doorbell Chime Installation

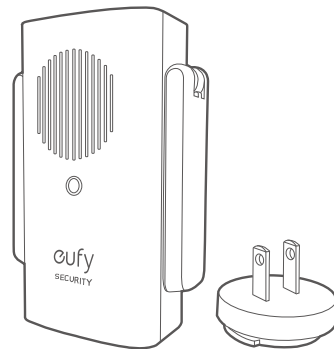

Model:Wi-Fi Doorbell Chime Power Plug
FCC ID: 2AOKB-T8020
IC: 23451-T8020

Note: Power plug may vary in different regions.

PRODUCT OVERVIEW

Video Doorbell (Battery Powered)

Front view:

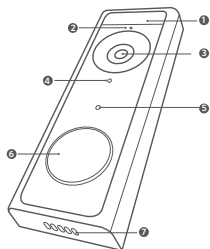

1. Motion Sensor
2. Microphone
3. Camera Lens
4. Ambient Light Sensor
5. Status LED
6. Doorbell Button
7. Speaker

Rear View:

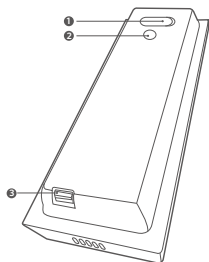

1. Micro USB Charging Port
2. SYNC/RESET button
3. Detaching Mechanism

Operation	How-to
Power on	Press and release the SYNC button.
Add doorbell to Wi-Fi Doorbell Chime	Press and hold the SYNC button until you hear a beep.
Power off the doorbell	Quick-press the SYNC 5 times in 3 seconds.
Reset the doorbell	Press and hold the SYNC button for 10 seconds.

HOW THE SYSTEM WORKS

How the System Works

The video doorbell system includes 2 parts:

- The video doorbell at your door
- The Wi-Fi Doorbell Chime in your house

The video doorbell detects motion at your porch and allows you to answer the door anytime and anywhere. The Wi-Fi Doorbell Chime stores video clips on a microSD card (user provides it) and works as an indoor digital chime. When someone rings the doorbell, people in the house will be notified.

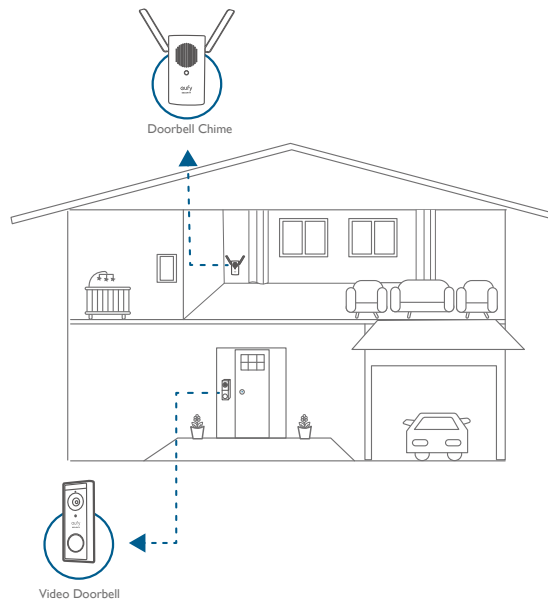

STEP 1 POWERING ON THE WI-FI DOORBELL CHIME

Connect the HomeBase 2 to the Internet

1. Fix the power connector to Wi-Fi Doorbell Chime.

- 1 Place the power connector over Wi-Fi Doorbell Chime in the direction the arrows indicate.
- 2 Align the raised slots of the power connector with the notch on the base of the doorbell chime.
- 3 Rotate clockwise to lock the power connector in place.

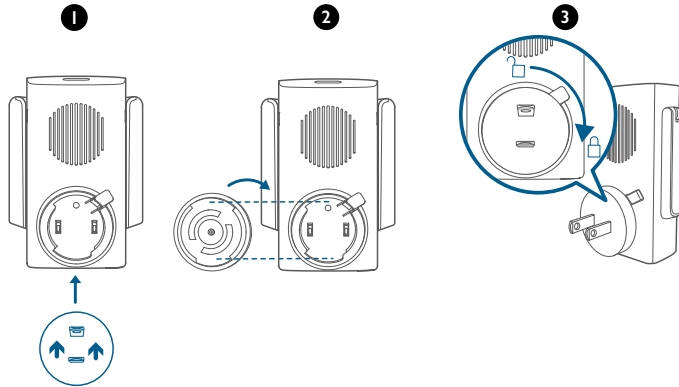

2. Extend Wi-Fi Doorbell Chime's antennas.

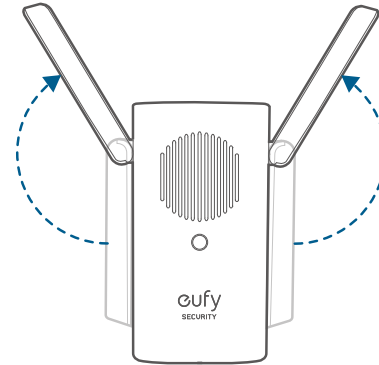

3. Plug Wi-Fi Doorbell Chime into an AC power supply at your desired location. The LED indicator turns solid green when the doorbell chime is ready for setup.

STEP 2 SETTING UP THE SYSTEM

Download the App and Set up the System

Download the eufy Security app from the App Store (iOS devices) or Google Play (Android devices).



Sign up for a eufy Security account and follow onscreen instructions to complete the setup.

Tap Add Device and add the following devices:

1. Add the Wi-Fi Doorbell Chime.
2. Add the doorbell.

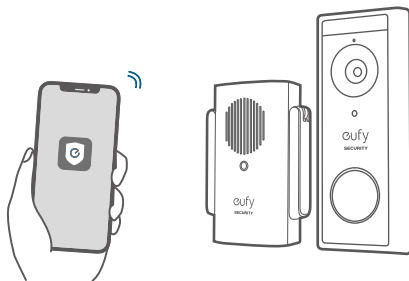

STEP 3 CHARGING YOUR DOORBELL

The doorbell comes with an 80% battery level for safe transportation. Fully charge it before mounting the doorbell at your front door.

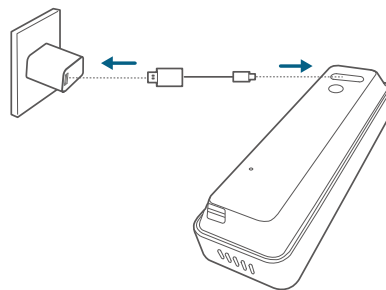

Note: The battery life varies depending on usage. In most common cases, a doorbell may have up to 15 events per day and each recording lasts 20 seconds on average. Under this scenario, the doorbell battery life can last up to 4 months.

STEP 4 FINDING A MOUNTING SPOT

Find a Mounting Spot

Take the Video Doorbell to your front door and check the live view on the eufy Security app at the same time. Find a position where you can get the desired field of view.

Consider the below factors:

1. Check if you can reuse the existing holes and anchors on the wall or door frame.
2. If you want to place the doorbell close to a side wall, make sure the wall doesn't show up in the field of view. Otherwise IR light will be reflected and night vision will become blurry.
3. If you are drilling the mounting holes for the first time the recommended mounting height is 48" / 1.2m from the ground.
4. Use the 15° mounting wedge as a supplementary mounting bracket if you wish to see more on a specific side.

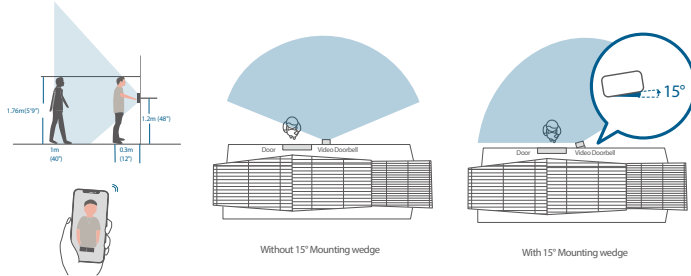

Place the Screw Hole Positioning Card against the wall to mark the position.

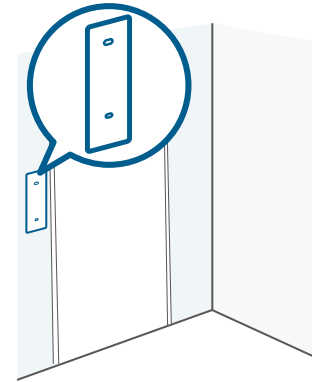

STEP 5 MOUNTING THE BRACKET

Mount the Doorbell on a Wooden Surface

If you're mounting the doorbell on a wooden surface, you don't need to pre-drill pilot holes. Use the provided screws to secure the Mounting Bracket on the wall. The Screw Hole Positioning Card indicates the position of the screw holes.

What is required: Power Drill, Mounting Bracket, 15° Mounting Wedge (Optional), Screw Packs

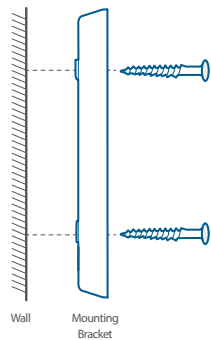
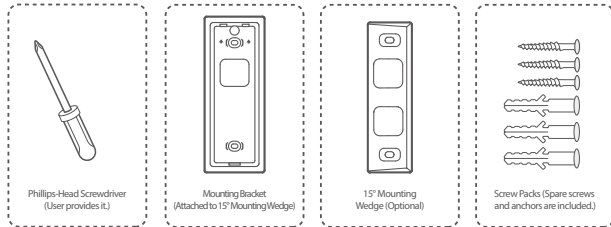

Without 15° Mounting Wedge

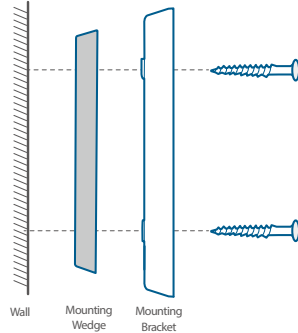

With 15° Mounting Wedge

Mount the Video Doorbell on Surfaces Made Out of Hard Materials

1. If you're mounting the doorbell on a surface made out of hard materials, like brick, concrete, stucco, drill 2 holes through the Screw Hole Positioning Card with 15/64"(6mm) drill bit.
2. Insert the provided anchors, and then use the provided long screws to secure the Mounting Bracket on the wall.

What is required: Power Drill, 15/64"(6mm) Drill Bit, Mounting Bracket, 15° Mounting Wedge (Optional), Screw Packs

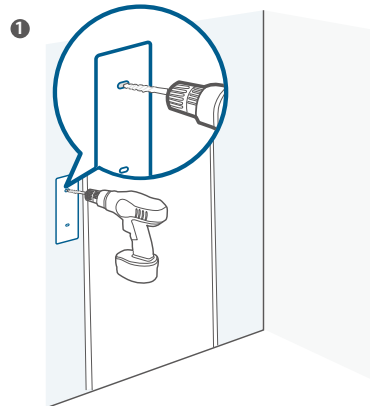
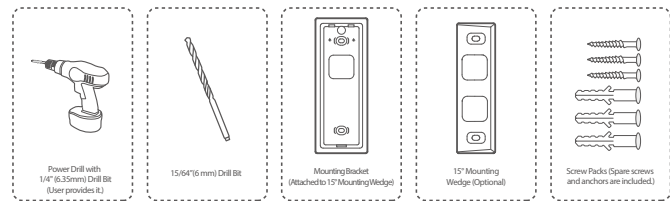

2

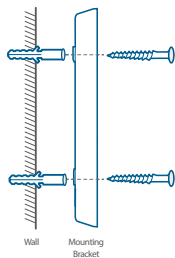

Without 15° Mounting Wedge

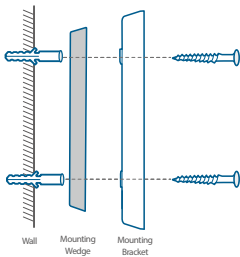

With 15° Mounting Wedge

STEP 6 MOUNTING THE DOORBELL

Mount the Doorbell

Align the doorbell with the top of the mount and then snap the bottom into place.

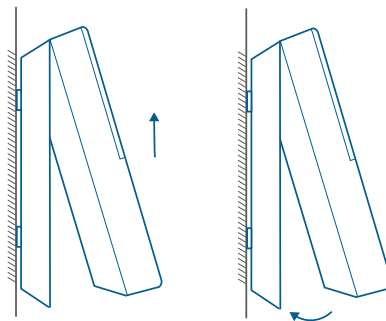

You're all set!

If you want to detach the doorbell or recharge it, please refer to the following sections.

APPENDIX I DETACHING THE DOORBELL

Detach the Doorbell

1. Use the doorbell detaching pin provided if you wish to detach the doorbell from the Mounting Bracket.
2. Insert and press the detaching pin into the hole on the bottom of the doorbell and then lift to take the bottom of the doorbell off.

What is required: Doorbell Detaching Pin

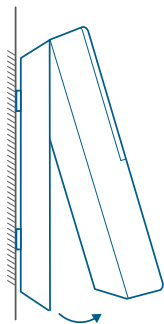
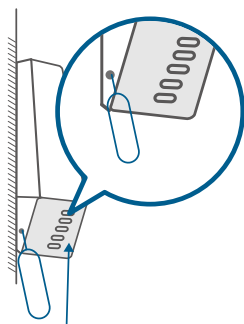
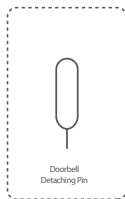

APPENDIX 2 RECHARGING THE DOORBELL

Recharge the Doorbell

Charge the doorbell with universal USB chargers that deliver 5V 1A output.

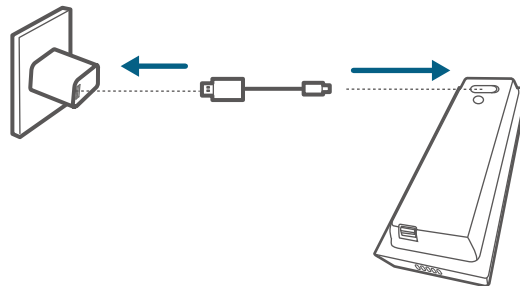

LED indication	Charging: Solid orange
	Fully charged: Solid blue
Charging time	6 hours from 0% to 100%

NOTICE

FCC Statement

This device complies with Part 15 of the FCC Rules. Operation is subject to the following two conditions: (1) this device may not cause harmful interference, and (2) this device must accept any interference received, including interference that may cause undesired operation.

Warning: Changes or modifications not expressly approved by the party responsible for compliance could void the user's authority to operate the equipment.

Note: This equipment has been tested and found to comply with the limits for a Class B digital device, pursuant to Part 15 of the FCC Rules. These limits are designed to provide reasonable protection against harmful interference in a residential installation.

This equipment generates uses and can radiate radio frequency energy and, if not installed and used in accordance with the instructions, may cause harmful interference to radio communications. However, there is no guarantee that interference will not occur in a particular installation. If this equipment does cause harmful interference to radio or television reception, which can be determined by turning the equipment off and on, the user is encouraged to try to correct the interference by one or more of the following measures: (1) Reorient or relocate the receiving antenna. (2) Increase the separation between the equipment and receiver. (3) Connect the equipment into an outlet on a circuit different from that to which the receiver is connected. (4) Consult the dealer or an experienced radio / TV technician for help.

FCC Radio Frequency Exposure Statement

The device has been evaluated to meet general RF exposure requirements. The device can be used in fixed/mobile exposure condition. The min separation distance is 20cm.

Notice: Shielded cables

All connections to other computing devices must be made using shielded cables to maintain compliance with FCC regulations.

The following importer is the responsible party:

Company Name: POWER MOBILE LIFE, LLC

Address: 400 108th Ave NE Ste 400, Bellevue, WA 98004-5541

Telephone: 1-800-988-7973



This product complies with the radio interference requirements of the European Community.

Declaration of Conformity

Hereby, Anker Innovations Limited declares that this device is in compliance with the essential requirements and other relevant provisions of Directive 2014/53/EU. For the declaration of conformity, visit the Web site: <https://www.eufylife.com/>.

This product can be used across EU member states.

Do not use the Device in the environment at too high or too low temperature, never expose the Device under strong sunshine or too wet environment.

The suitable temperature for T8020 and accessories is 0°C-40°C.

The suitable temperature for T8222 and accessories is -20°C-50°C.

When charging, please place the device in an environment that has a normal room temperature and good ventilation.

It is recommended to charge the device in an environment with a temperature that ranges from 5°C~25°C.

RF exposure information: The Maximum Permissible Exposure (MPE) level has been calculated based on a distance of d=20 cm between the device and the human body. To maintain compliance with RF exposure requirement, use product that maintain a 20cm distance between the device and human body.

CAUTION RISK OF EXPLOSION IF BATTERY IS REPLACED BY AN INCORRECT TYPE. DISPOSE OF USED BATTERIES ACCORDING TO THE INSTRUCTIONS

Wifi Operating Frequency Range: 2412~2472MHz (2.4G)

Wifi Max Output Power: 15.68dBm (ERIP for T8020); 15.01dBm (ERIP for T8220)

Bluetooth Operating Frequency Range: 2402~2480MHz; Bluetooth Max Output Power: 2.048dBm (EIRP)

The following importer is the responsible party (contact for EU matters only)

Importer: Anker Technology (UK) Ltd

Importer Address: Suite B, Fairgate House, 205 Kings Road, Tyseley, Birmingham, B11 2AA, United Kingdom



This product is designed and manufactured with high quality materials and components, which can be recycled and reused.



This symbol means the product must not be discarded as household waste, and should be delivered to an appropriate collection facility for recycling. Proper disposal and recycling helps protect natural resources, human health and the environment. For more information on disposal and recycling of this product, contact your local municipality, disposal service, or the shop where you bought this product.

IC Statement

This device complies with Industry Canada licence-exempt RSS standard(s). Operation is subject to the following two conditions:

- (1) this device may not cause interference, and
- (2) this device must accept any interference, including interference that may cause undesired operation of the device."

This Class B digital apparatus complies with Canadian ICES-003.

Cet appareil numérique de la classe B est conforme à la norme NMB-003 du Canada.

IC RF Statement:

When using the product, maintain a distance of 20cm from the body to ensure compliance with RF exposure requirements.

Lors de l'utilisation du produit, maintenez une distance de 20 cm du corps afin de vous conformer aux exigences en matière d'exposition RF.

CUSTOMER SERVICE

Warranty



12-month limited warranty



(US) +1 (800) 988 7973 Mon-Fri 9:00-17:00 (PT)

(UK) + 44 (0) 1604 936 200 Mon-Fri 6:00-11:00 (GMT)

(DE) +49 (0) 69 9579 7960 Mon-Fri 6:00-11:00



Customer Support: support@eufylife.com

Anker Innovations Limited

Room 1318-19, Hollywood Plaza, 610 Nathan Road, Mongkok, Kowloon, Hong Kong



@EufyOfficial



@EufyOfficial



eufyofficial