

A letter of recognition

DESCRIBE: Anker Innovations Co., LTD (T8214)

Customer NO: 13706-D4W0008R-00

PART NO: ATC1380-HY057B04RA

Antenna type: 2.4G FPC ANT

DATE: 2023. 06. 30

PROVIDER: AT&C TECHNOLOGIES(SHENZHEN) CO. LTD

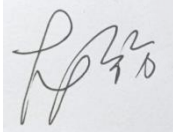
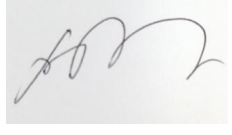
		ID Department	Test department	Structure section	Quality department
Customer Admit	confirm				
Supplier Admit		confirm	Proofreading	To examine	Approval
	confirm		MO zenweng	Xuliying	

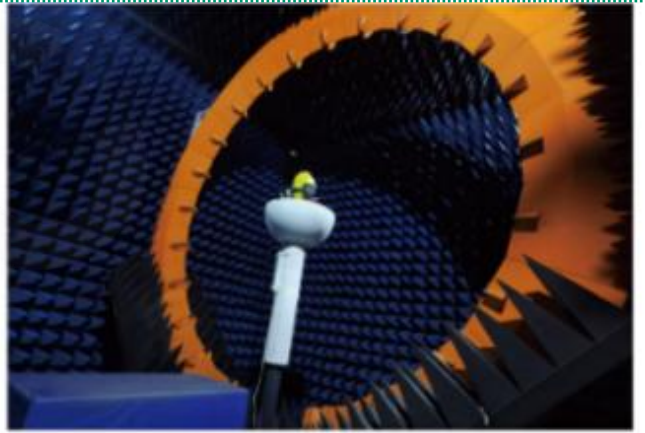
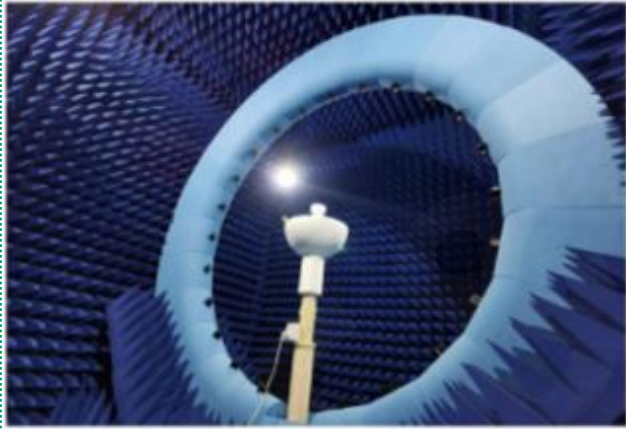

We have RF equipments as below

Anechoic Chambe

- Satimo 1ea
- SY24 1ea
- SAR 1ea
- KSS 2ea

Measurement

- 2G, 3G, 4G
- GPS
- Wifi
- Bluetooth(3.0) OTA
- NFC & WPC



T8214-ANT

Antenna impedance matching

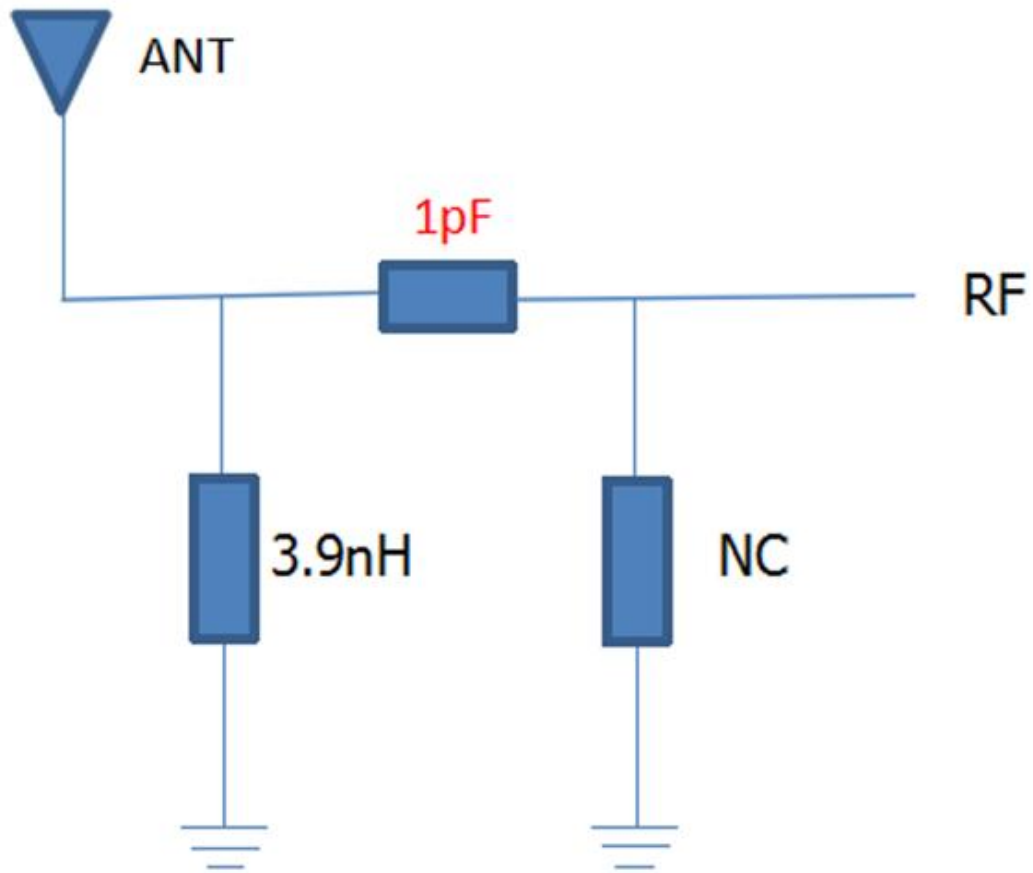

Parallel 3.9 NH inductor, series 1PF capacitor

1 Active Ch/Trace 2 Response 3 Stimulus 4 Mkr/Analysis 5 Instr State

Tr1 S11 Log Mag 5.000dB/ Ref 0.000dB [F1]



Tr2 S11 SWR 1.000/ Ref 1.000 [F1]



Tr3 S11 Smith (R+jX) Scale 1.000U [F1]

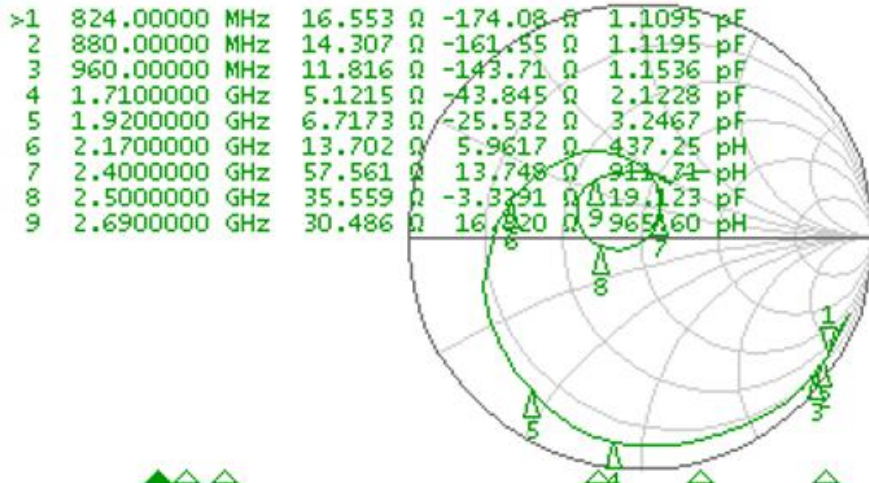

1 Start 500 MHz

IFBW 70 kHz

Stop 3.1 GHz

Sim PExt C?

Antenna *Efficiency

(2.4G) Passive Test Results

Frequency (MHz)	Efficiency (%)	Efficiency (dB)	Max Gain (dBi)
2400	58.93%	-2.30	2.52
2410	60.40%	-2.19	2.65
2420	61.12%	-2.14	2.79
2430	61.99%	-2.08	2.90
2440	60.04%	-2.22	2.99
2450	61.42%	-2.12	2.93
2460	60.45%	-2.19	2.72
2470	60.63%	-2.17	2.75
2480	63.01%	-2.01	3.01
2490	65.37%	-1.85	3.21
2500	64.10%	-1.93	3.04
AVG:	61.59%	-2.11	2.86

H

E1

E2

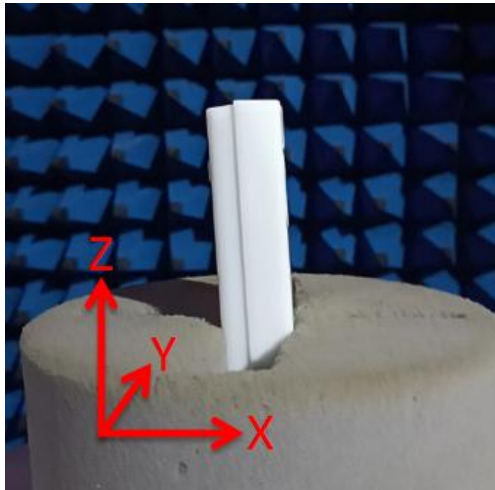
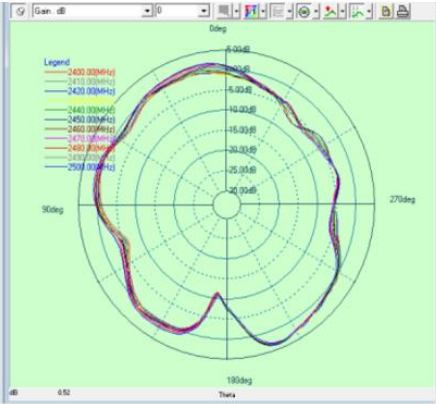
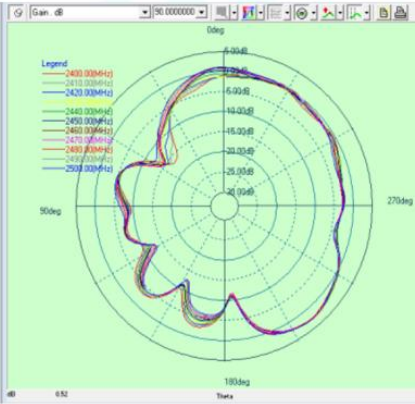
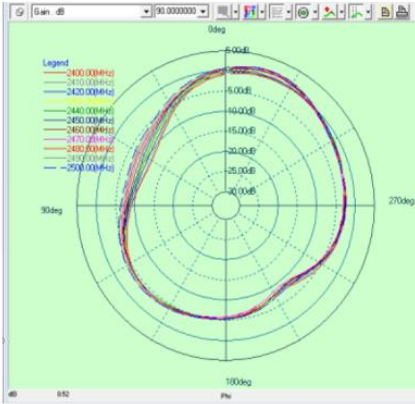

SEQ No.	REV	DATE	DESCRIPTION OF CHANGE	DRAWN	CHECKED	APPROVED
1						

☉ 正面 (TOP)

☉ 背面 (BOTTOM)

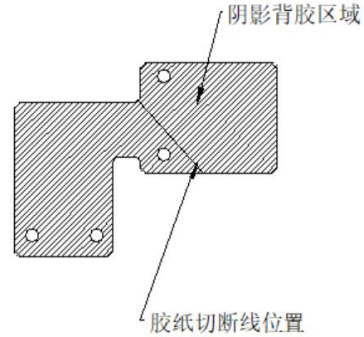
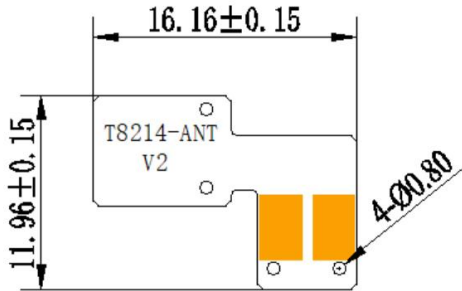

Note:

- 1: 一般公差按: $\pm 0.15\text{mm}$
- 2: 产品表面: 黑色哑光 丝印白色字符清楚可见, 如图位置所示, 垫板包装
- 3: 背胶使用3M9471 材质半对半 接触位需镀金
- 4: 测试尺寸需按云高型纸附贴平面进行测量。
- 5: 正面, 背面, 外面无可见气泡及异物, 盐雾需过48H
- 6: 材料需符合ROHS要求

产品名	厂家	材质	颜色	厚度	'A' 本体	'B' 端子脚
本体垫层	鹏瑞	BLACK/WHITE (40)	BLACK/WHITE	10	10	
本体垫层	鹏瑞	BLACK/WHITE (40)	BLACK/WHITE			
电镀区域		AU (镀)	GOLD	0.085-0.05		6.5
铜层		Cu-1/2oz	Yellow	18	18	18
阻焊层	三美	PI-1/2mil	Yellow	12.5	12.5	12.5
PI 阻焊						
本体胶	3M		Clear	50	50	50
背胶层				120	120	120



X	± 0.5	3rd ANGLE PROJECTION		 AT&C Co., LTD.(Shenzhen)	
.X	± 0.25	COPYRIGHT:AT&C.2009.04.05			
.XX	± 0.10	THIS NOTICE DOES NOT IMPLY PUBLICATION.			
.XXX	± 0.05				
CHECKED BY		SIZE	SI A4	PART NAME	T8214 FPC 黑色
DRAWN BY	LNF	UNITS	mm	MODEL NAME	WIFI-Ant
APPROVED BY	Ins	SCALE	1:1	DRAWING NUMBER	ATC1380-HY057B04RA
				DRAWING DATE	2023.04.21

ATNC-S-01-A4

A4(297X210)

Size information					Measuring sample			% Tolerance		Handling opinions			Measuring tool
number	Dimension property	Dimension	Lower tolerance	Upper tolerance	1	2	3	Upper	Lower	determine	Supplier review comments	Customer review comments	
1	key point	16.16	-0.15	0.15	16.15	16.17	16.09			PASS			PJ
2	key point	11.96	-0.15	0.15	11.95	11.91	12.02			PASS			PJ
3	key point	0.8	-0.05	0.05	0.82	0.80	0.84			PASS			PJ

Salt spray test report

Item name	FPC ANT	Item type	ATC-1380	models	T8214
The experimental class	Salt spray test	Number of items	5 pcs	The researchers	Zhangxuemei
The experiment	Sample reliability verification				
Experimental conditions	<p>Brine concentration for 5 plus or minus 1%, salt water barrels and the temperature of the laboratory to 35 + 2 °C, saturated air barrel temperature to 47 + 2 °C, PH: 6.5-7.5 KGF/cm2, spray quantity: 1-2 ml / 1 hr / 80 cm2, test time 48 h.</p> <p>Specific reference GBT 10125-1997 standard</p>				
Note:					
The experiment on	《Inspection standard for plated parts》				
The equipment used:	Salt spray test chamber				
The experiment					
After the experiment					
The experimental conclusion:	After the test, clean water was rinsed and the surface of the shrapnel was not oxidized, discolored or blackened for 2H;				
Tester/date: ren kangyong 2023.06.08			Audit: Pengguangliang		

Packaging method

PE bag packaging, product emission neat, uniform quantity



Picture: Outer box "I" seal, QC PASS seal on the left side of the outer box, sealed without exposure.



PART LIST

The packing drawing is schematic diagram, which does not mean that the picture is the actual product and the actual shipment is the standard.

NO	DESCRIPTION	Q'TY	MATERIAL	REMARKS	REV.
1	ANTENNA	1/1000		N/A	A
2	PAD OUT	1/4	SW A골 5T	N/A	A
4	CARTOON BOX	-	SW A골 5T	N/A	A
5	PACKING TAPE	-	PP	N/A	A