

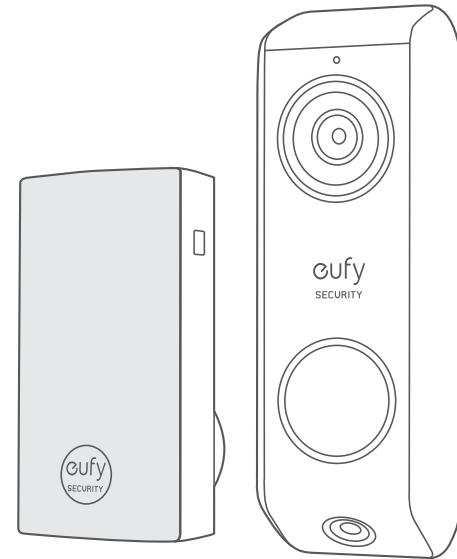

QUICK START GUIDE

eufy Video Doorbell Dual (Wired)



Anker Innovations Limited. All rights reserved. eufy Security and eufy Security Logo are trademarks of Anker Innovations Limited, registered in the United States and other countries. All other trademarks are the property of their respective owners.

51005002970 V01

1 / PRODUCT OVERVIEW



eufy Video Doorbell
Dual (Wired)
Model: T8203

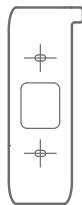

Screw Hole
Positioning-Card

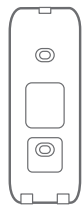

Mounting Bracket
(Attached to 15°
Mounting Wedge)

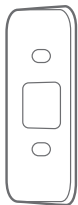

15° Mounting Wedge
(Optional)

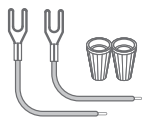

Extension Wires and Wire
Nuts (Optional)

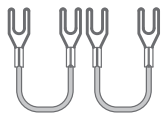

Jumper for Existing
Chime (The second one is
optional)

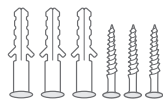

Screw Packs (Spare screws
and anchors are included.)



Pin



Doorbell Chime
Model: T8742



Doorbell Chime
Power connector
(The pin type may vary in
different regions.)



Quick Start Guide

What You Need:

- Phillips-Head Screwdriver
- Power Drill with 1/4" (6.35mm) Drill Bit

2 / HOW THE SYSTEM WORKS

The Video Doorbell system includes 2 parts. One is the video doorbell at your porch. The other is the electronic chime plugged on indoor power socket. The video doorbell is powered by existing doorbell wires. In order to get sufficient power from the doorbell circuit, user needs to bypass the existing doorbell chime on the circuit.

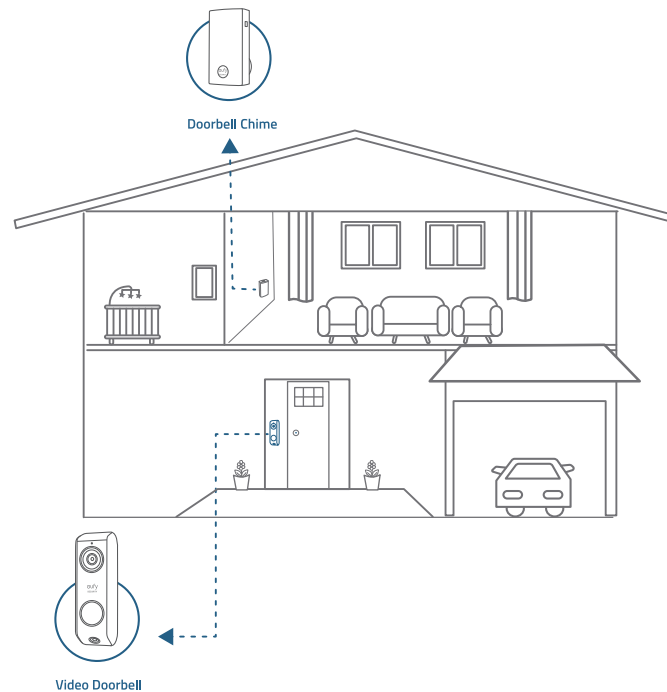

3 / APP INSTALLATION

1. Download and install the eufy Security app, then sign up for an account.



2. Add video doorbell and scan the QR code for later installation process. The QR code can be found on the back of the video doorbell.

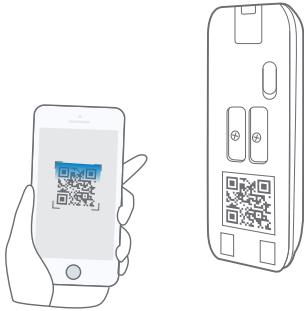

4 / VIDEO DOORBELL INSTALLATION

Note: Make sure you have installed the eufy Security App and scan the QR code before handling the doorbell installation.

Step 1

Ring off the existing doorbell, make sure it's working and locate the place of your existing chimes in the house.

Step 2

Shut off the doorbell power supply. If you're not sure, shut off the main power supply in your house. Turn the lights in your home on / off to make sure the electricity in your house is properly shut off.

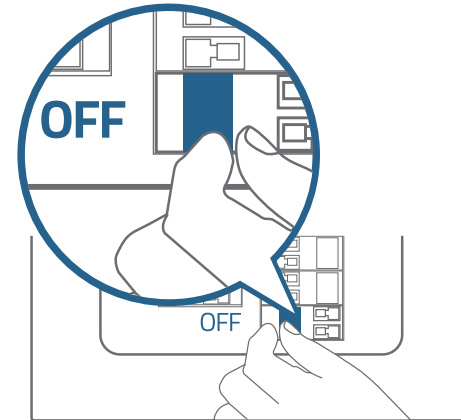

Note: Always be careful when handling electricity wiring. If you're not comfortable to do it yourself, do consult a qualified electrician.

Step 3

Find the doorbell chime in your house, then remove the cover and find the screw terminals with TRANS and FRONT markings. Use the provided jumper for existing chime to connect the two terminals. This is to bypass the doorbell chime and will not affect the normal operation of the circuit.

Note:

- The video doorbell requires user to bypass the existing chime first to get sufficient power. Without this step, the video doorbell will still be able to power on but will operate unstably.
- In most cases, the existing doorbell circuit looks like below chart. Find the existing doorbell chime in your house, remove the cover and take a photo of the wire connection in case you need to reconnect it.
- Use the provided jumper to connect FRONT and TRANS terminals to bypass the chime on the circuit. Do not remove the original wire connecting to the chime. If your doorbell chime has different markings or you have multiple chimes, refer to the help session in the App for the custom wiring instructions or consult a qualified electrician.
- When the jumper is in place, the existing chime will not sound anymore.

What are required: Jumper for existing chime / Phillips-Head Screwdriver

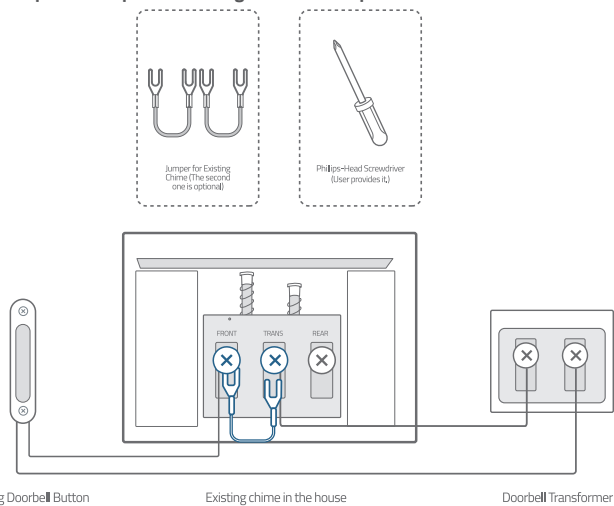

Step 4

Remove the existing doorbell button at the front door. Pull the two wires out carefully when removing the old doorbell. Straighten the wire ends if necessary.

What's required: Phillips-Head Screwdriver

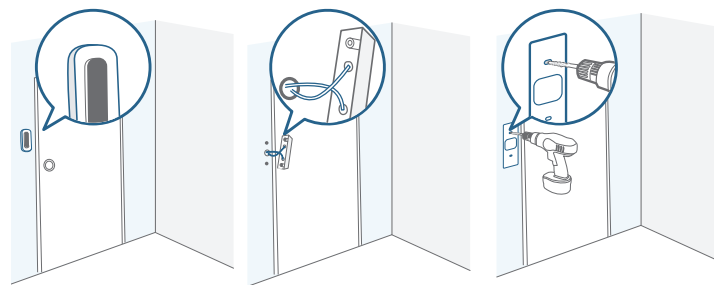
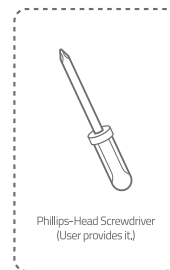

Step 5

Determine the mounting position of the doorbell. Consider the below factors:

1. Check if you can reuse the existing holes and anchors on the wall or door frame.
2. If you are drilling the mounting holes for the first time the recommended mounting height is 48" from the ground.

If you are mounting the doorbell on a wooden wall or board, do NOT drill holes. Skip to Step 7 and use screws directly to mount the Mounting Bracket.

If your wall is stucco, brick or concrete, you need to drill holes. Use the Screw Hole Positioning-Card to mark the position and drill holes with 1/4" (6.35mm) drill bit.

What are required: Power Drill with 1/4" (6.35mm) Drill Bit / Screw Hole Positioning-Card

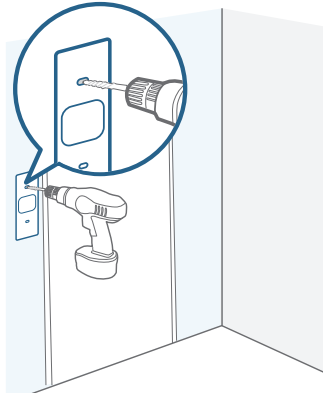
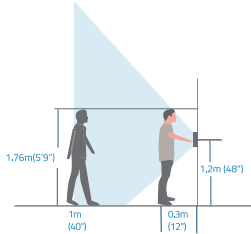
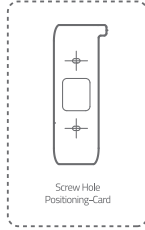

Optional: Use the 15° mounting wedge as a supplementary mounting bracket if you wish to see more on a specific side.

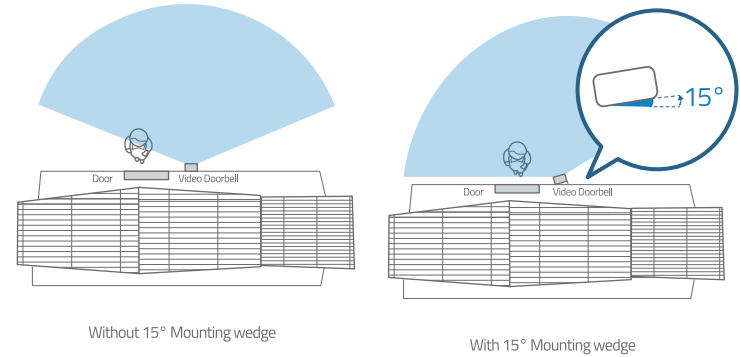

Step 6

Use the anchors provided when installing in materials such as stucco, brick, or concrete. There is no need to use anchor if you were installing on wooden doorframe.

What's required: Anchors

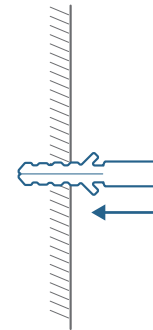
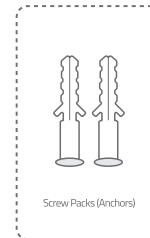

Step 7

Lead the two doorbell wires through the central square hole on the bracket before start mounting.

Insert the two screws provided through the screw holes or through the 15° mounting wedge(Install the mounting bracket to the 15° mounting wedge in prior), and fasten the screws tightly.

What are required: Mounting Bracket / Screw Packs / 15° Mounting Wedge(Optional) / Phillips-Head Screwdriver

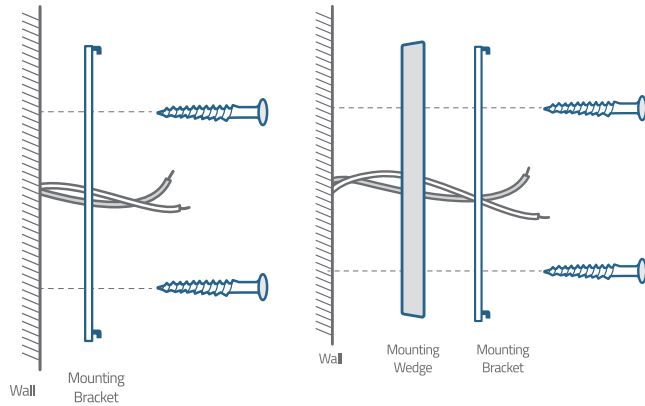
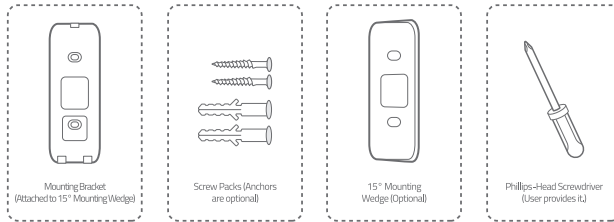

With 15° Mounting Wedge

Step 8

Connect the wires to the two terminals at the back of the doorbell, then tighten the terminal screws. Wire can connect to any terminal as the electric current is alternating current.

Note: To prevent short-circuit, make sure the wires are not touching each other after connecting them to the terminals. If the wires are too short, use the extension wires and wire nuts provided to make them longer. Use electrical wiring tape to secure the connection if the wall doesn't have space for wire nuts.

What are required: Extension Wires and Wire Nuts (Optional) / Video doorbell / Philips-Head Screwdriver

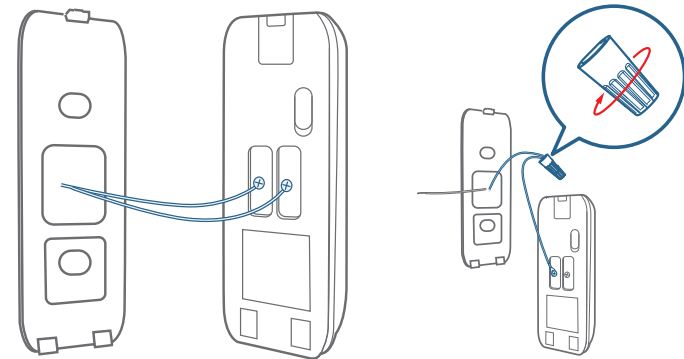
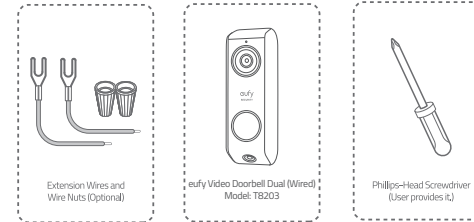

Step 9

There are 2 thermal conductive pads on the mounting bracket. They're used to conduct heat from video doorbell to the metal bracket. Remove the films on the thermal conductive pads before you mount the doorbell.

Align the doorbell on the bottom, and then move it into place on top. Press the doorbell down until it clicks.

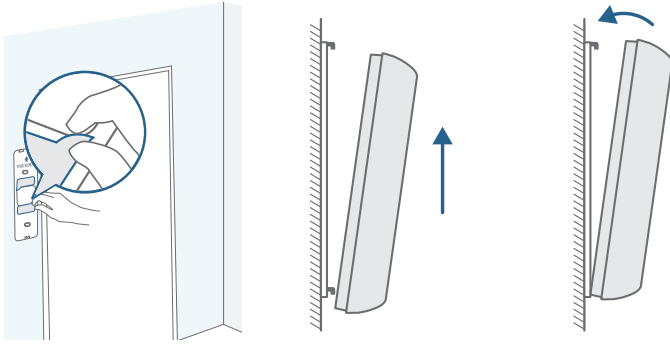

Use the doorbell detaching pin provided if you wish to detach the doorbell from the mounting bracket.

The detaching pin has magnet pad on the black-color side. Stick it on iron surface where you can find it easily.

Note: The oval holes are speaker holes. Only press the round hole to detach the doorbell.

What's required: Doorbell detaching pin

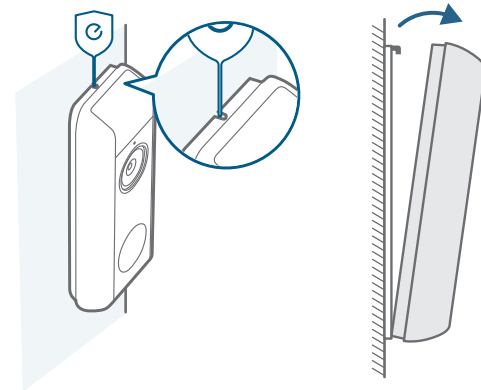
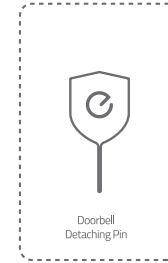

Step 10

Switch the doorbell or master circuit breaker to ON.

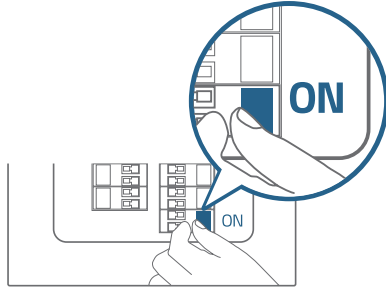

Step 11

Wait until the doorbell ring flashes blue. Then follow the on-screen instructions in eufy Security App to connect the video doorbell to your home Wi-Fi.



Step 12

Follow the on-screen instructions in eufy Security App. Install the doorbell power connector to the doorbell chime and then pair it to your video doorbell.

Note: One video doorbell can link up to 4 electronic chimes. Use the volume and music buttons on the side of the electronic chime to adjust the volume and ringtone.

What are required: Doorbell chime / Doorbell chime power connector

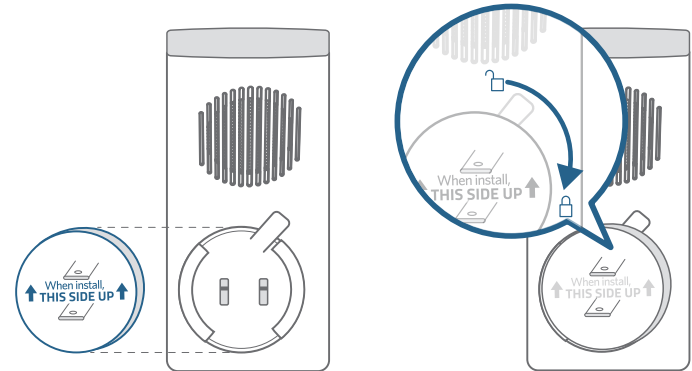
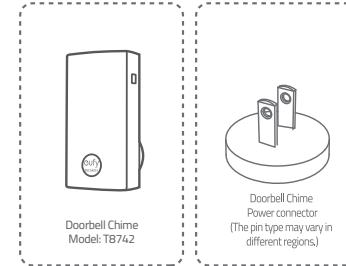

5 / NOTICE

NOTICE (Canada)

This device complies with Industry Canada licence-exempt RSS standard(s). Operation is subject to the following two conditions:

- (1) this device may not cause interference, and
- (2) this device must accept any interference, including interference that may cause undesired operation of the device."

Le présent appareil est conforme aux CNR d'Industrie Canada applicables aux appareils radio exempts de licence. L'exploitation est autorisée aux deux conditions suivantes:

- (1) l'appareil ne doit pas produire de brouillage, et
- (2) l'utilisateur de l'appareil doit accepter tout brouillage radioélectrique subi, même si le brouillage est susceptible d'en compromettre le fonctionnement."

This Class B digital apparatus complies with Canadian ICES-003.
Cet appareil numérique de la classe B est conforme à la norme NMB-003 du Canada.

IC RF Statement:

When using the product, maintain a distance of 20cm from the body to ensure compliance with RF exposure requirements.

Lors de l'utilisation du produit, maintenez une distance de 20 cm du corps afin de vous conformer aux exigences en matière d'exposition RF.

NOTICE (United States Of America)

FCC Statement

This device complies with Part 15 of the FCC Rules. Operation is subject to the following two conditions: (1) this device may not cause harmful interference, and (2) this device must accept any interference received, including interference that may cause undesired operation.

Warning: Changes or modifications not expressly approved by the party responsible for compliance could void the user's authority to operate the equipment.

Note: This equipment has been tested and found to comply with the limits for a Class B digital device, pursuant to Part 15 of the FCC Rules. These limits are designed to provide reasonable protection against harmful interference in a residential installation.

This equipment generates uses and can radiate radio frequency energy and, if not installed and used in accordance with the instructions, may cause harmful interference to radio communications. However, there is no guarantee that interference will not occur in a particular installation. If this equipment does cause harmful interference to radio or television reception, which can be determined by turning the equipment off and on, the user is encouraged to try to correct the interference by one or more of the following measures: (1) Reorient or relocate the receiving antenna. (2) Increase the separation between the equipment and receiver. (3) Connect the equipment into an outlet on a circuit different from that to which the receiver is connected. (4) Consult the dealer or an experienced radio/TV technician for help.

FCC Radio Frequency Exposure Statement

The device has been evaluated to meet general RF exposure requirements. The device can be used in fixed/mobile exposure condition. The min separation distance is 20cm.

Notice: Shielded cables

All connections to other computing devices must be made using shielded cables to maintain compliance with FCC regulations.

The following importer is the responsible party

Company Name: POWER MOBILE LIFE, LLC

Address: 10900 NE 8th St, Ste 501, Bellevue WA 98004

Telephone: 1-800-988-7973

