

eufy
SECURITY

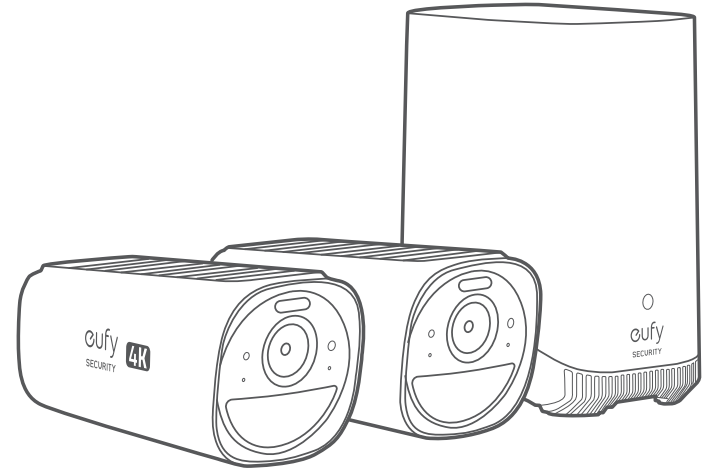

S330 eufyCam

QUICK START GUIDE

Anker Innovations Limited. All rights reserved. eufy Security and eufy Security Logo are trademarks of Anker Innovations Limited, registered in the United States and other countries. All other trademarks are the property of their respective owners.

51005003397 V01

AT A GLANCE

S330 eufyCam

Model: T8160

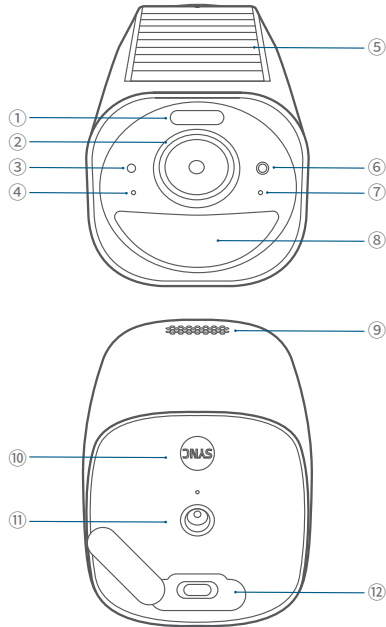

- ① Spotlight
- ② Camera Lens
- ③ Photosensitive Sensor
- ④ Microphone 1
- ⑤ Solar Panel
- ⑥ LED Indicator
- ⑦ Microphone 2
- ⑧ Motion Sensor
- ⑨ Speaker
- ⑩ SYNC Button
- ⑪ Mounting Hole
- ⑫ USB-C Charging Port

S380 HomeBase

Model: T8030

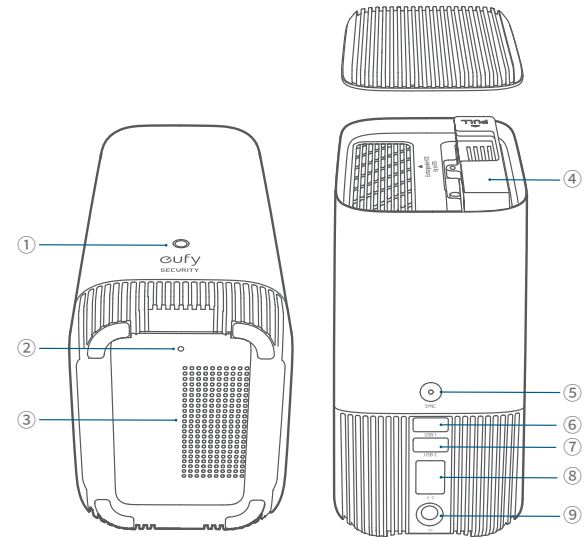

- ① Status LED
- ② Reset Hole
- ③ Speaker
- ④ Hard Drive Bracket
- ⑤ SYNC / ALARM OFF Button
- ⑥ USB Port 1
- ⑦ USB Port 2
- ⑧ Ethernet Port
- ⑨ Power Port

EXPANDING STORAGE (OPTIONAL)

S380 HomeBase comes with 16 GB of storage for saving video recordings and allows you to add an additional hard drive to expand the space.

Prepare Your Hard Drive

Your hard drive must meet the following requirements:

| | |
|--------------------|---|
| Type | Hard disk drive (HDD) or solid state drive (SSD) that uses the SATA interface |
| Size | 2.5 inch |
| Capacity | Unlimited |
| Recommended | Western Digital, Seagate, SAMSUNG, Kingston, PNY, Crucial, SanDisk |

 Transfer all the data in your hard drive to a secure location before adding it to S380 HomeBase.

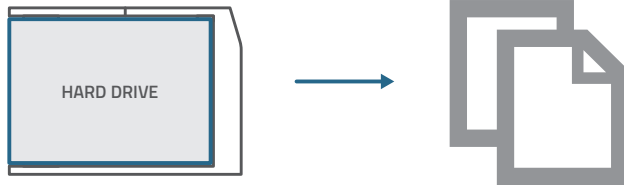

Install Your Hard Drive

 S380 HomeBase must be powered off when you install or remove a hard drive.

1. Push down the top lid to remove it.

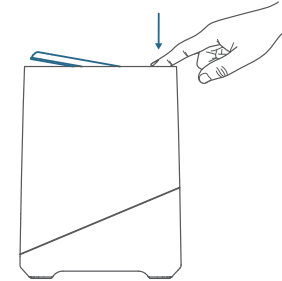

2. Loosen the screw, then pull out the hard drive bracket.

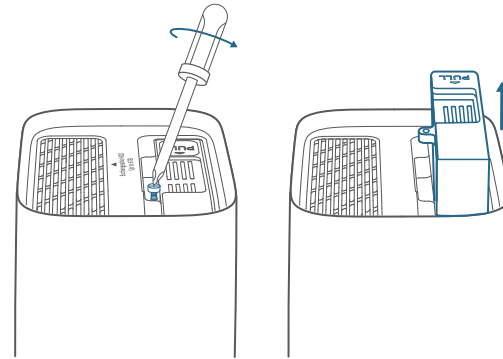

3. Fix your hard drive to the bracket with the provided screws.

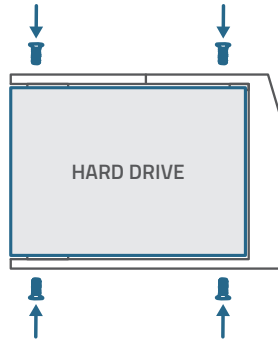

4. Insert and screw the bracket back to S380 HomeBase, then put the top lid back into place.

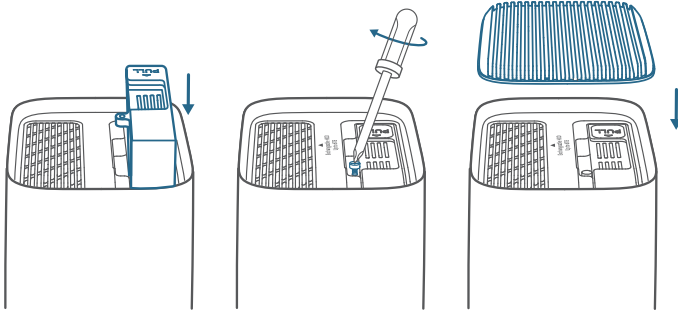

- You can follow the steps above to expand the storage whenever necessary.
- A new hard drive must be initialized through the eufy Security app to work with S380 HomeBase.

SETTING UP

1. Power and connect S380 HomeBase to your router. The LED indicator will turn blue (This may take about 1 min) when S380 HomeBase is ready for setup.

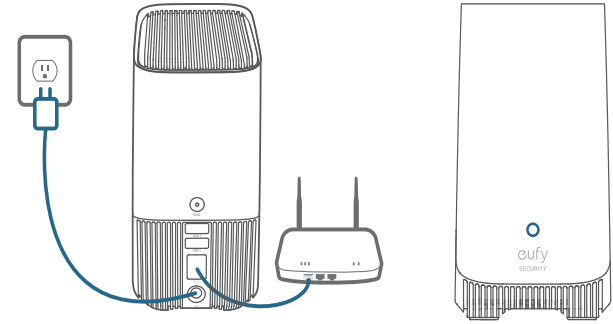

2. Download and install the eufy Security app, then sign up for an account.



3. Follow on-screen instructions to add S380 HomeBase and the cameras to your device list(*).

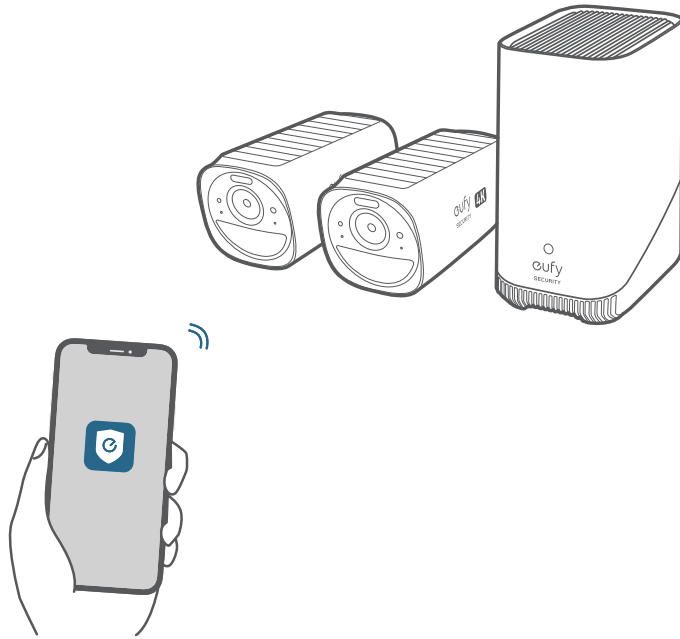

* One S380 HomeBase can pair up to 16 cameras.

CHARGING THE CAMERA

Fully charge both cameras before first use. This may take about 8 hours for each.

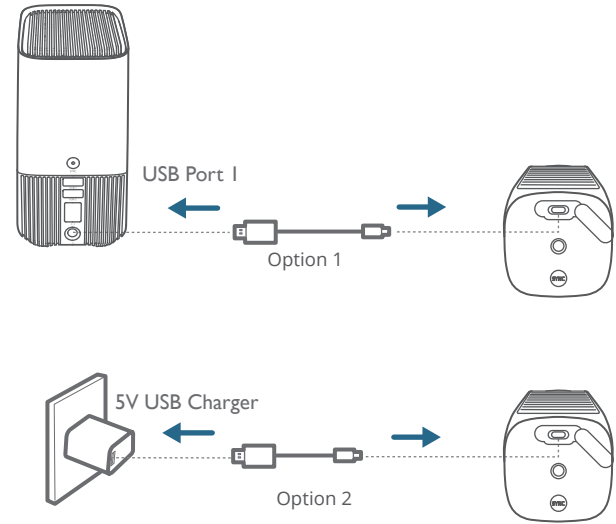

| LED Indicator | Description |
|---------------|---------------|
| Blue | Charging |
| OFF | Fully charged |

S330 eufyCam includes a solar panel that converts sunlight into electrical energy and keeps the built-in battery charged every day.

The charging efficiency fluctuates according to the intensity of the sunlight.

Don't worry when the battery level goes down. It happens when there isn't enough sunlight or the camera is consuming more power than usual.

You don't need to charge the camera with a cable until a low battery alarm goes off.

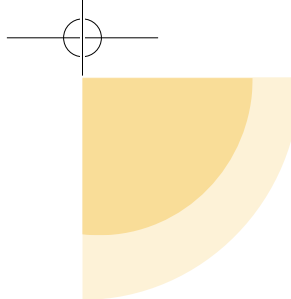
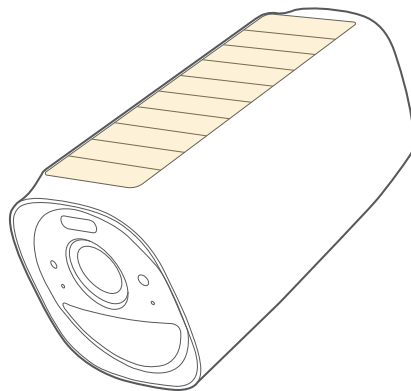

2 HOURS PER DAY*

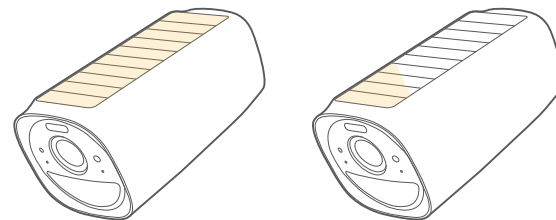

*** Make sure the solar panel can be fully exposed to direct sunlight for at least 2 hours per day.**

MOUNTING THE CAMERA

Select a Location

Select a location where you can get the desired view. We recommend hanging the camera 7-10 ft (2-3 m) above the ground.

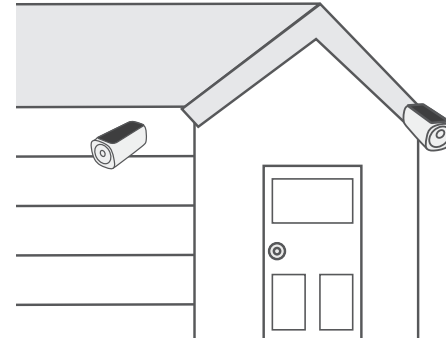
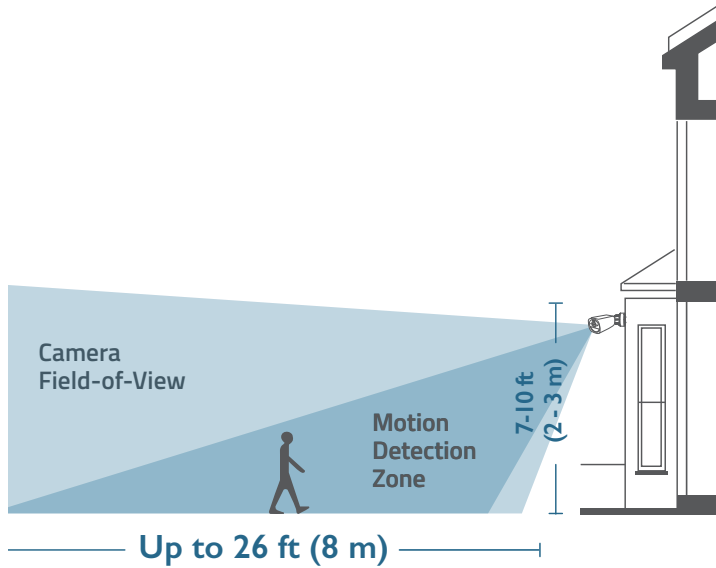

- Best places to install:**
- Wall without eaves
 - A pole or fence where sunlight is not blocked
 - Over eaves, if the eaves are below 3 m high

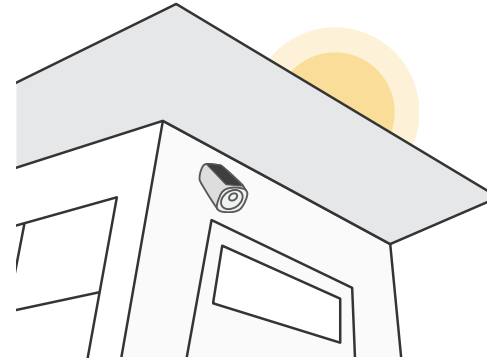

- Places not to install:**
- Inside your home or under the porch
 - Under or on a tree
 - Under slanted eaves



Mount the Camera

1. Turn the knob of the mounting bracket counterclockwise to loosen and disassemble it.

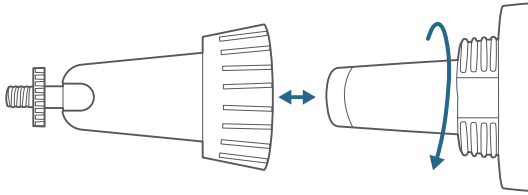

2. Drill holes with a 15/64 inch (6 mm) drill bit, then insert the anchors into the holes; anchors are necessary for walls that are made out of hard materials such as concrete, brick, or stucco.

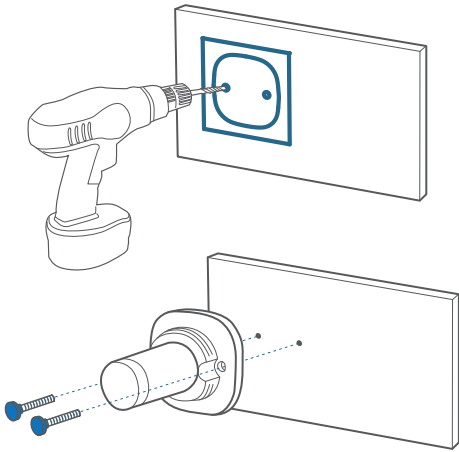

3. Firmly screw the knob of the mounting bracket into the mounting hole.

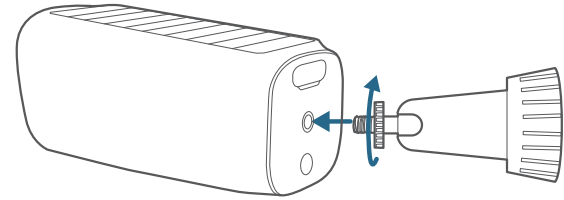

4. Hold and screw the camera to the mounting bracket. Rotate the camera to adjust the view and check it using the live stream, which you can access in the eufy Security app.

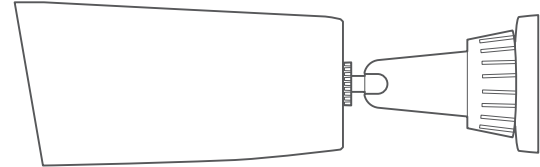

For troubleshooting, check Help on the eufy Security app. Refer to the app page for LED indicator status.

SAFETY

- Do not use the device in the environment at a too high or too low temperature, never expose the device to strong sunshine or too wet environment.
- The suitable temperature for T8030 and accessories is -10°C to 45°C .
- The suitable temperature for T8160 and accessories is -20°C to 50°C (Charging temperature is 0°C to 45°C) .
- It is recommended to supply the device in an environment with a temperature that ranges from 5°C~25°C.
- When supplying, please place the device in an environment that has a normal room temperature and good ventilation.
- The adapter shall be installed near the equipment and shall be easily accessible.
- Please ensure to use only the adapter offered by the manufacturer. Using unauthorized adapter may cause danger and violate the authorization of the device and the guarantee article.
- This adapter is for indoor use only. The adapter type (for S380 HomeBase) is KA2401A-1202000US, rated output voltage/current is 12 Vdc/2A. The plug is considered as disconnect device of adapter.

Warning:

- Replacement of a battery with an incorrect type can defeat a safeguard;
- Disposal of a battery into fire or a hot oven, or mechanically crushing or cutting of a battery can result in an explosion;
- Leaving a battery in an extremely high temperature surrounding environment can result in an explosion or the leakage of flammable liquid or gas; and
- A battery subjected to extremely low air pressure may result in an explosion or the leakage of flammable liquid or gas.

Attention:

- remplacement d'une batterie par un type incorrect pouvant supprimer une protection
- mise au rebut d'une batterie dans un feu ou dans un four chaud, ou écrasement mécanique ou coupure d'une batterie, susceptible de provoquer une explosion;
- maintien d'une batterie dans un environnement à très haute température pouvant provoquer une explosion ou la fuite de liquide ou de gaz inflammables; et
- batterie soumise à une pression de l'air extrêmement faible pouvant provoquer une explosion ou la fuite de liquide ou de gaz inflammables.

 CAUTION: RISK OF EXPLOSION IF BATTERY IS REPLACED BY AN INCORRECT TYPE. DISPOSE OF USED BATTERIES ACCORDING TO THE INSTRUCTIONS.

 ATTENTION RISQUE D'EXPLOSION SI LA BATTERIE EST REMPLACÉE PAR UN TYPE INCORRECT. ÉLIMINER LES BATTERIES USÉES SELON LES INSTRUCTIONS.

NOTICE

NOTICE (United States of America)

FCC Statement

This device complies with Part 15 of the FCC Rules. Operation is subject to the following two conditions: (1) this device may not cause harmful interference, and (2) this device must accept any interference received, including interference that may cause undesired operation.

Warning: Changes or modifications not expressly approved by the party responsible for compliance could void the user's authority to operate the equipment.

Note: This equipment has been tested and found to comply with the limits for a Class B digital device, pursuant to Part 15 of the FCC Rules. These limits are designed to provide reasonable protection against harmful interference in a residential installation.

This equipment generates uses and can radiate radio frequency energy and, if not installed and used in accordance with the instructions, may cause harmful interference to radio communications. However, there is no guarantee that interference will not occur in a particular installation. If this equipment does cause harmful interference to radio or television reception, which can be determined by turning the equipment off and on, the user is encouraged to try to correct the interference by one or more of the following measures: (1) Reorient or relocate the receiving antenna. (2) Increase the separation between the equipment and receiver. (3) Connect the equipment into an outlet on a circuit different from that to which the receiver is connected. (4) Consult the dealer or an experienced radio/TV technician for help.

FCC Radio Frequency Exposure Statement

The device has been evaluated to meet general RF exposure requirements. The device can be used in fixed/mobile exposure condition. The min separation distance is 20cm.

Notice: Shielded cables

All connections to other computing devices must be made using shielded cables to maintain compliance with FCC regulations.

The following importer is the responsible party

Company Name: POWER MOBILE LIFE, LLC

Address: 10900 NE 8th St, Ste 501, Bellevue WA 98004

Telephone:1-800-988-7973

NOTICE (Canada)

This device complies with Industry Canada licence-exempt RSS standard(s).

Operation is subject to the following two conditions:

- (1) this device may not cause interference, and
- (2) this device must accept any interference, including interference that may cause undesired operation of the device.

Le présent appareil est conforme aux CNR d'Industrie Canada applicables aux appareils radio exempts de licence. L'exploitation est autorisée aux deux conditions suivantes:

- (1) l'appareil ne doit pas produire de brouillage, et
- (2) l'utilisateur de l'appareil doit accepter tout brouillage radioélectrique subi, même si le brouillage est susceptible d'en compromettre le fonctionnement.

This Class B digital apparatus complies with Canadian ICES-003.

Cet appareil numérique de la classe B est conforme à la norme NMB-003 du Canada.

IC RF Statement:

When using the product, maintain a distance of 20cm from the body to ensure compliance with RF exposure requirements.

Lors de l'utilisation du produit, maintenez une distance de 20 cm du corps afin de vous conformer aux exigences en matière d'exposition RF.



Your product is designed and manufactured with high quality materials and components, which can be recycled and reused.



This symbol means the product must not be discarded as household waste, and should be delivered to an appropriate collection facility for recycling. Proper disposal and recycling helps protect natural resources, human health and the environment. For more information on disposal and recycling of this product, contact your local municipality, disposal service, or the shop where you bought this product.

Anker Innovations Limited
Room 1318-19, Hollywood Plaza, 610 Nathan Road, Mongkok, Kowloon, Hong Kong



12-month limited warranty



United States

+1 (800) 988 7973

Mon-Sat 6:15AM-6:45PM(PT)

Sun 6:15AM-5:45PM(PT)

United Kingdom

+44 (0) 1604 936 200

Mon-Sun 6:00-19:00

Germany

+49 (0) 69 9579 7960

Mo-Fr 8:00-16:00 Sa 9:00-16:00



support@eufylife.com



@EufyOfficial



@EufyOfficial



@EufyOfficial

Anker Innovations Limited
Room 1318-19, Hollywood Plaza, 610 Nathan Road, Mongkok, Kowloon, Hong Kong