

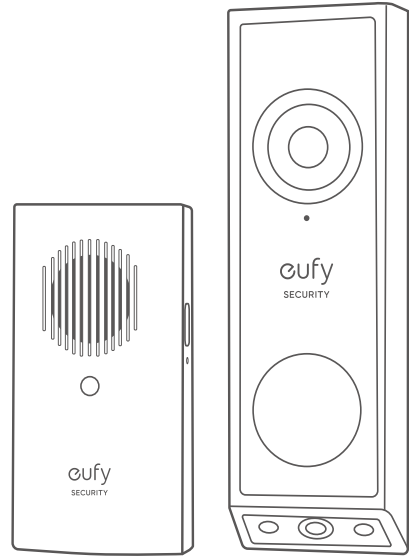

QUICK START GUIDE

Video Doorbell E340 with Chime



Anker Innovations Limited. All rights reserved. eufy Security and eufy Security Logo are trademarks of Anker Innovations Limited, registered in the United States and other countries. All other trademarks are the property of their respective owners.

AT A GLANCE

Front View

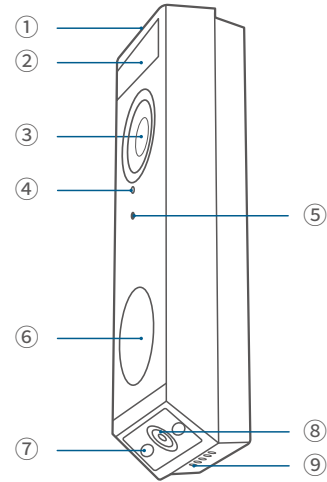

Model: T8214
Video Doorbell E340

- ① LED Light
- ② Motion Sensor
- ③ Primary Camera Lens
- ④ Microphone
- ⑤ Ambient Light Sensor
- ⑥ LED Ring / Doorbell Button
- ⑦ LED Light
- ⑧ Secondary Camera Lens
- ⑨ Speaker

Rear View

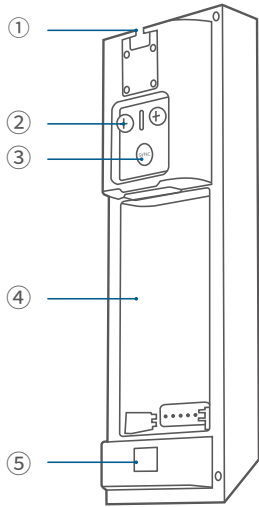

- ① Detaching Mechanism
- ② Power Terminals for Existing Doorbell Wires (Optional)
- ③ SYNC Button
Press to turn on the doorbell.
Press and hold for 2 seconds until you hear a beep to set up the doorbell. (Optional)
Press quickly 5 times within 3 seconds to turn off the doorbell.
- ④ Battery Compartment
- ⑤ QR Code (Scan to add the doorbell in the app)

Doorbell Chime



Model: T8023
MiniBase Chime

- ① SYNC Button
- ② Speaker
- ③ microSD Card Slot
- ④ Status LED
- ⑤ Reset Hole
- ⑥ Power plug (varies by region)

HOW THE SYSTEM WORKS

Works with eufy Security Doorbell Chime

The video doorbell detects motion at your porch and lets you to answer the door anytime, anywhere. The Wi-Fi doorbell chime works as an indoor digital chime and stores video clips on a microSD card (not included). When someone rings the doorbell, people in the house will be notified.

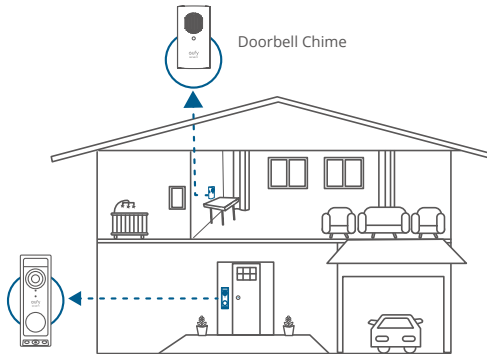

Works with eufy Security HomeBase (Optional)

The video doorbell detects motion at your porch and lets you to answer the door anytime, anywhere. You can store video clips in the built-in storage of your eufy Security HomeBase 2 or S380 HomeBase (sold separately). When someone rings the doorbell, people in the house will be notified.

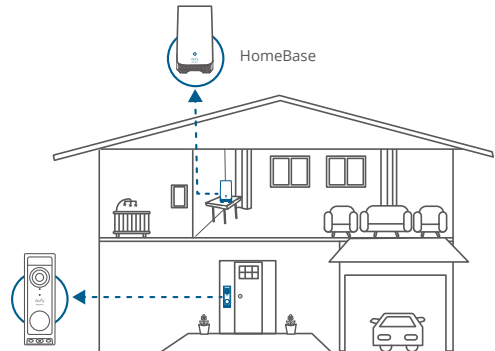

POWERING ON THE WI-FI DOORBELL CHIME

1. Attach the power connector to the doorbell chime.

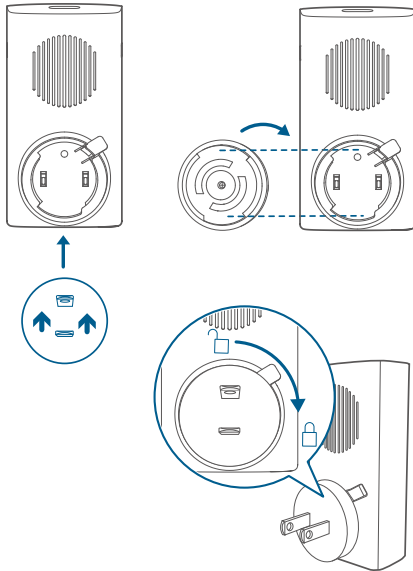

2. Plug the doorbell chime into a wall outlet at your desired location. The LED indicator turns solid green when the doorbell chime is ready for setup.

CHARGING THE BATTERY PACK

1. Remove the pre-installed battery pack from the battery compartment.

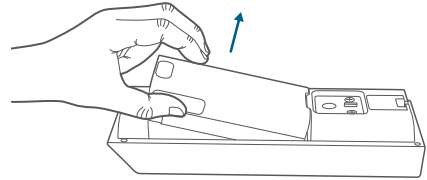

2. Fully charge the rechargeable battery pack before installation.

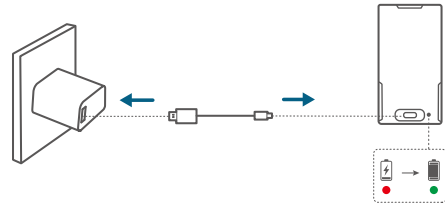

3. Place the battery pack into the battery compartment.

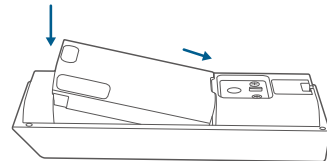

SETTING UP THE SYSTEM

1. Download and install the eufy Security app, then sign in or create an account.



2. Follow the in-app instructions to add the video doorbell and the Wi-Fi doorbell chime.

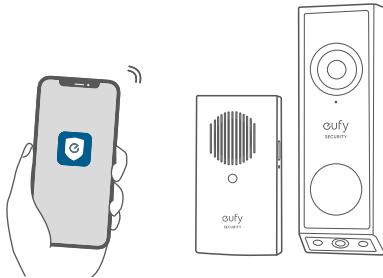

DETERMING THE POWER OPTION

Option 1: Battery Powered

If you don't have existing doorbell wiring at your front door, use the included battery. You are free to determine the location of the doorbell, and the mounting will be easy and quick.

When the battery is low, you will need to recharge it. Battery life varies with use. If you choose this option, please skip to **DOORBELL MOUNTING (Battery Powered)**.

Option 2: Wire Powered

If you have existing and working doorbell wires at your front door, the video doorbell will be constantly powered by these wires. So there's no need to detach and recharge after installation.

The mounting position is limited. If you choose this option, please skip to **DOORBELL MOUNTING (Wire Powered)**.

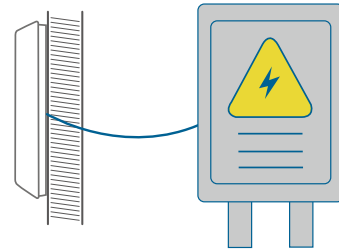

DOORBELL MOUNTING (Battery Powered)

Choose a Location

1. Take the video doorbell to your front door and check the live view in the app. Choose a location where you can see the desired field of view. Consider the following factors:
 - Check if you can reuse the existing holes and anchors in the wall or door frame.
 - If you want to place the doorbell near a side wall, make sure the wall isn't in the field of view. Otherwise, the IR light will be reflected and the night vision will be blurred.
 - If you are drilling the mounting holes for the first time, the recommended height is 48" (1.2m) above the ground.
 - To adjust the angle, use the 15° mounting wedge as a supplementary mounting bracket.

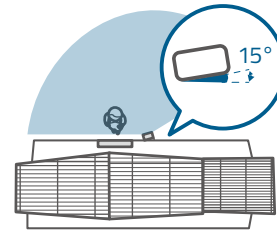
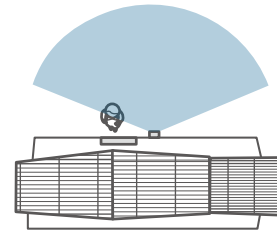
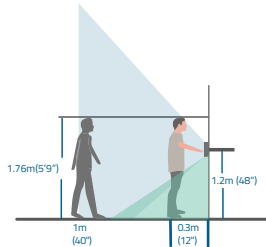

2. Place the screw hole positioning card against the wall to mark the location. If mounting on a hard wall (brick, concrete, or stucco), use a 15/64" (5.95mm) drill bit to drill 2 holes through the screw hole positioning card.

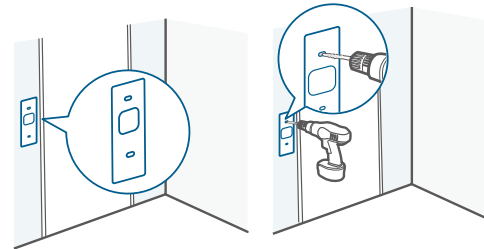

What you need: Phillips-Head Screwdriver; Power Drill
(15/64" Drill Bit)

Mount the Bracket

Use the provided screws to secure the mounting bracket on the wall.

Wooden Wall

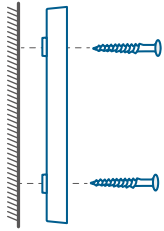

Mounting
Bracket

Without 15°
Mounting Wedge

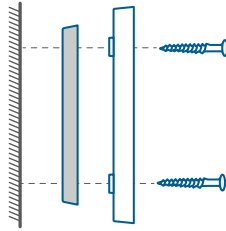

Mounting
Wedge Mounting
Bracket

With 15°
Mounting Wedge

Hard Wall

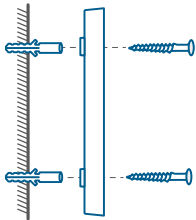

Mounting
Bracket

Without 15°
Mounting Wedge

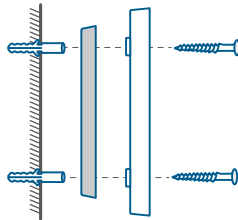

Mounting
Wedge Mounting
Bracket

With 15°
Mounting Wedge

Install the Doorbell

Align the doorbell with the bottom of the mounting bracket, then press the top of the doorbell into place until it clicks.

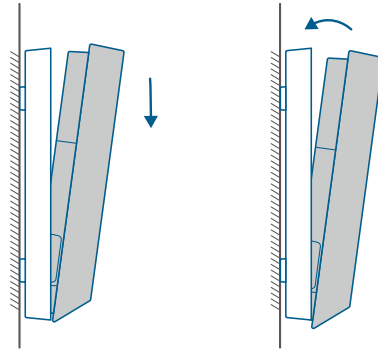

Recharging the Battery

1. Insert the detaching pin into the pin hole on the top of the doorbell, then lift the top for removal.

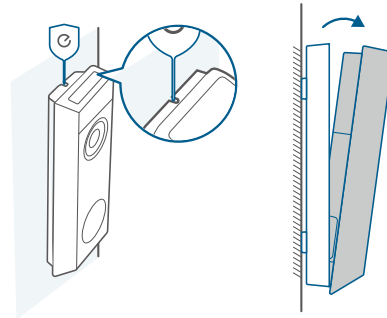

2. Repeat steps in "**CHARGING THE BATTERY PACK**".



You can purchase an extra battery pack for quick replacement.

DOORBELL MOUNTING (Wire Powered)

Check the Doorbell Wires

1. Ring the existing doorbell to check if it is working. If it doesn't ring, your doorbell wires may be defective. Power on the doorbell by the built-in battery or consult an electrician to repair the wires.
2. Shut off the power at the circuit breaker. Turn the lights on and off to make sure the electricity in your home is properly shut off.

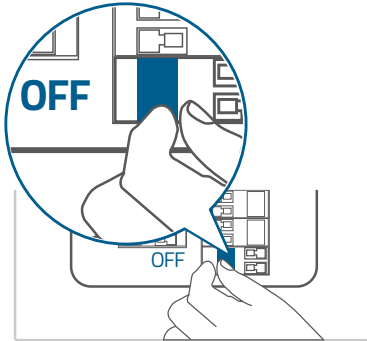

Always be careful when handling wires. If you're not comfortable installing it yourself, have a qualified electrician to do it.

Detach the Existing Doorbell Button

If you already have existing doorbell wiring:

1. Remove the existing doorbell button with a Phillips-head screwdriver (not provided).
2. Pull the two wires out carefully when removing the existing doorbell. Straighten the wire ends if necessary.

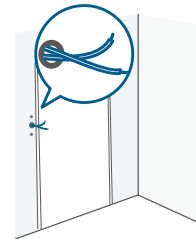
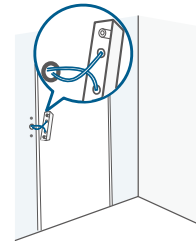
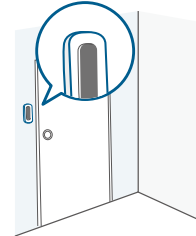

Choose a Location

1. Take the video doorbell to your front door and check the live view in the app. Choose a location where you can see the desired field of view. Consider the following factors:

- Check if you can reuse the existing holes and anchors in the wall or door frame.
- If you want to place the doorbell near a side wall, make sure the wall isn't in the field of view. Otherwise, the IR light will be reflected and the night vision will be blurred.
- If you are drilling the mounting holes for the first time, the recommended height is 48" (1.2m) above the ground.
- To adjust the angle, use the 15° mounting wedge as a supplementary mounting bracket.

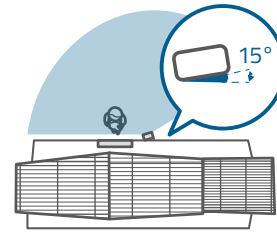
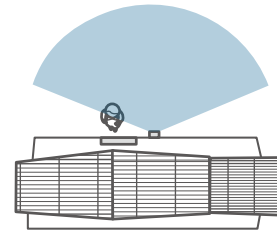
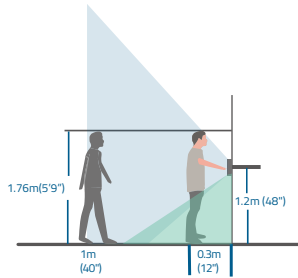

2. Place the screw hole positioning card against the wall to mark the location. If mounting on a hard wall (brick, concrete, or stucco), use a 15/64" (5.95mm) drill bit to drill 2 holes through the screw hole positioning card.

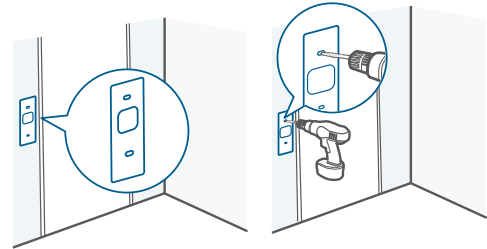

What you need: Phillips-Head Screwdriver; Power Drill (15/64" Drill Bit)

Mount the Bracket

Use the provided screws to secure the mounting bracket on the wall.

Wooden Wall

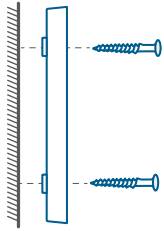

Mounting
Bracket

Without 15°
Mounting Wedge

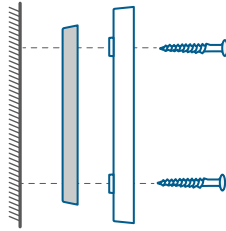

Mounting
Wedge Mounting
Bracket

With 15°
Mounting Wedge

Hard Wall

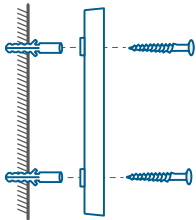

Mounting
Bracket

Without 15°
Mounting Wedge

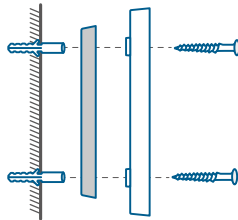

Mounting
Wedge Mounting
Bracket

With 15°
Mounting Wedge

Connect the Wires to the Doorbell

Connect the wires to the terminals on the back of the doorbell, then tighten the terminal screws. Wire can be connected to any terminal.

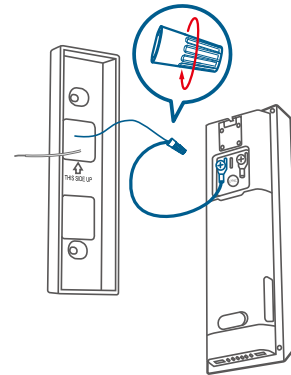
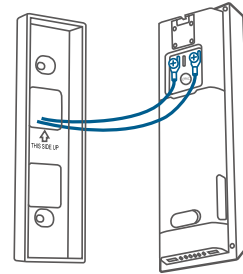

To prevent short-circuiting, make sure the wires are not touching each other after connecting them to the terminals.

If the wires are too short, use the extension wires and wire nuts to make them longer. Use electrical wiring tape instead if there is no more space on the wall for wire nuts.

Install the Doorbell

Align the doorbell with the bottom of the mounting bracket, then press the top of the doorbell into place until it clicks.

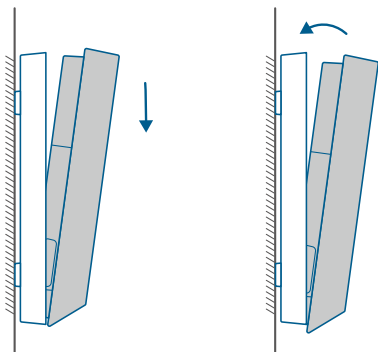

Restore Power

Switch the main circuit breaker back to **ON**. You're all set!

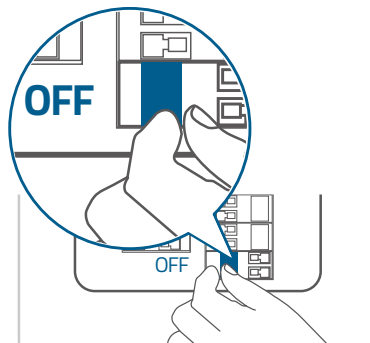

SAFETY

- The suitable temperature for T8214 and accessories is -20°C to 50°C (Charging temperature is 0°C to 40°C).
- The suitable temperature for T8023 and accessories is 0°C to 40°C.
- Unless specifically indicated that it is safe to do so in the user guide or instruction manual, do not use this device in an environment that exceeds the recommended low or high temperature.
- Unless specifically indicated that it is safe to do so in the user guide or instruction manual, avoid exposing your device to direct sunshine or excessively wet environments.
- It is recommended to charge the device in an environment with a temperature that ranges from 5°C to 25°C.
- When charging, place the device in an environment that has a normal room temperature and good ventilation.
- For pluggable equipment, the socket-outlet shall be easily accessible.



CAUTION!

THERE IS A RISK OF EXPLOSION IF AN INCORRECT BATTERY TYPE IS USED. DISPOSE OF USED BATTERIES ACCORDING TO THEIR INSTRUCTIONS.



ATTENTION!

IL EXISTE UN RISQUE D'EXPLOSION EN CAS D'UTILISATION D'UN TYPE DE PILE INCORRECT. ÉLIMINEZ LES PILES USAGÉES CONFORMÉMENT AUX INSTRUCTIONS.

Warning:

- Replacing a battery with an incorrect type may bypass safeguards and create danger;
- Disposal of a battery in a fire or other source of significant heat, or by crushing, or cutting, may result in an explosion as well as leakage of flammable liquids and gases;
- Leaving a battery in an extremely hot environment may result in an explosion as well as leakage of flammable liquids and gases;
- A battery subjected to extremely low air pressure may result in an explosion as well as leakage of flammable liquids and gases.

Attention :

- Le remplacement d'une batterie par un type incorrect peut contourner les protections et créer un danger ;
- L'élimination d'une pile dans un feu ou une autre source de chaleur importante, ou par écrasement ou découpage, peut entraîner une explosion ainsi qu'une fuite de liquides et de gaz inflammables ;
- Le fait de laisser une batterie dans un environnement extrêmement chaud peut entraîner une explosion ainsi qu'une fuite de liquides et de gaz inflammables ;
- Une batterie soumise à une pression d'air extrêmement faible peut provoquer une explosion ainsi qu'une fuite de liquides et de gaz inflammables.

NOTICE

FCC Statement

This device complies with Part 15 of the FCC Rules. Operation is subject to the following two conditions: (1) this device may not cause harmful interference, and (2) this device must accept any interference received, including interference that may cause undesired operation.

Warning: Changes or modifications not expressly approved by the party responsible or compliance could void the user's authority to operate the equipment.

Note: This equipment has been tested and found to comply with the limits for a Class B digital device, pursuant to Part 15 of the FCC Rules. These limits are designed to provide reasonable protection against harmful interference in a residential installation.

This equipment generates uses and can radiate radio frequency energy and, if not installed and used in accordance with the instructions, may cause harmful interference to radio communications. However, there is no guarantee that interference will not occur in a particular installation. If this equipment does cause harmful interference to radio or television reception, which can be determined by turning the equipment off and on, the user is encouraged to try to correct the interference by one or more of the following measures: (1) Reorient or relocate the receiving antenna. (2) Increase the separation between the equipment and receiver. (3) Connect the equipment into an outlet on a circuit different from that to which the receiver is connected. (4) Consult the dealer or an experienced radio/TV technician for help.

FCC Radio Frequency Exposure Statement

The device has been evaluated to meet general RF exposure requirements. The device can be used in fixed/mobile exposure condition. The min separation distance is 20cm.

Notice: Shielded cables

All connections to other computing devices must be made using shielded cables to maintain compliance with FCC regulations.

The following importer is the responsible party:

Company Name: POWER MOBILE LIFE, LLC

Address: 10900 NE 8th St, Ste 501, Bellevue WA 98004

Telephone: 1-800-988-7973

IC Statement

This device complies with Industry Canada licence-exempt RSS standard(s). Operation is subject to the following two conditions:

(1) this device may not cause interference, and
(2) this device must accept any interference, including interference that may cause undesired operation of the device."

Le présent appareil est conforme aux CNR d'Industrie Canada applicables aux appareils radio exempts de licence. L'exploitation est autorisée aux deux conditions suivantes:

(1) l'appareil ne doit pas produire de brouillage, et

(2) l'utilisateur de l'appareil doit accepter tout brouillage radioélectrique subi, même si le brouillage est susceptible d'en compromettre le fonctionnement."

This Class B digital apparatus complies with Canadian ICES-003.

22

Cet appareil numérique de la classe B est conforme à la norme NMB-003 du Canada.

IC RF Statement

When using the product, maintain a distance of 20cm from the body to ensure compliance with RF exposure requirements.

Lors de l'utilisation du produit, maintenez une distance de 20 cm du corps afin de vous conformer aux exigences en matière d'exposition RF.

CUSTOMER SERVICE



12-month limited warranty



(US) +1 (800) 988-7973

(UK) +44 (0) 1604 936200

(DE) +49 (0) 69 9579 7960

(中国) +86 400 0550 036

(日本) +81 03 4455 7823

(AU) +61 3 8331 4800

(Egypt) +20 8000000826

(UAE) +971 8000320817

(Kuwait) +965 22069086

(Saudi Arabia) +966 8008500030



support@eufy.com

Anker Innovations Limited
Room 1318-19, Hollywood Plaza, 610 Nathan Road,
Mongkok, Kowloon, Hong Kong



@EufyOfficial



@EufyOfficial



@EufyOfficial