

FCC TEST REPORT

For

Anker Innovations Limited

Roav Bolt

Model No.: R5360

Prepared For : Anker Innovations Limited
Address : Room 1318-19, Hollywood Plaza, 610 Nathan Road, Mongkok, Kowloon,
Hong Kong

Prepared By : Shenzhen Anbotek Compliance Laboratory Limited
Address : 1/F, Building D, Sogood Science and Technology Park, Sanwei
community, Hangcheng Street, Bao'an District, Shenzhen, Guangdong,
China.518102
Tel: (86) 755-26066440 Fax: (86) 755-26014772

Report Number : SZAWW180724007-02

Date of Receipt : Jul. 24, 2018

Date of Test : Jul. 24~Dec. 25, 2018

Date of Report : Dec. 25, 2018

Contents

1. General Information.....	5
1.1. Client Information.....	5
1.2. Description of Device (EUT).....	5
1.3. Auxiliary Equipment Used During Test.....	5
1.4. Description of Test Modes.....	6
1.5. List of channels.....	7
1.6. Description Of Test Setup.....	8
1.7. Test Equipment List.....	9
1.8. Measurement Uncertainty.....	10
1.9. Description of Test Facility.....	10
2. Summary of Test Results.....	11
3. Conducted Emission Test.....	12
3.1. Test Standard and Limit.....	12
3.2. Test Setup.....	12
3.3. Test Procedure.....	12
3.4. Test Data.....	12
4. Radiation Spurious Emission and Band Edge.....	13
4.1. Test Standard and Limit.....	13
4.2. Test Setup.....	13
4.3. Test Procedure.....	14
4.4. Test Data.....	15
5. Maximum Peak Output Power Test.....	24
5.1. Test Standard and Limit.....	24
5.2. Test Setup.....	24
5.3. Test Procedure.....	24
5.4. Test Data.....	24
6. 6DB Occupy Bandwidth Test.....	27
6.1. Test Standard and Limit.....	27
6.2. Test Setup.....	27
6.3. Test Procedure.....	27
6.4. Test Data.....	27
7. Power Spectral Density Test.....	30
7.1. Test Standard and Limit.....	30
7.2. Test Setup.....	30
7.3. Test Procedure.....	30
7.4. Test Data.....	30
8. 100kHz Bandwidth of Frequency Band Edge Requirement.....	33
8.1. Test Standard and Limit.....	33
8.2. Test Setup.....	33
8.3. Test Procedure.....	33
8.4. Test Data.....	33
9. Antenna Requirement.....	37

9.1. Test Standard and Requirement..... 37

9.2. Antenna Connected Construction..... 37

APPENDIX I -- TEST SETUP PHOTOGRAPH..... 38

APPENDIX II -- EXTERNAL PHOTOGRAPH..... 39

APPENDIX III -- INTERNAL PHOTOGRAPH..... 41

TEST REPORT

Applicant : Anker Innovations Limited
Manufacturer : Anker Innovations Limited
Product Name : Roav Bolt
Model No. : R5360
Trade Mark : ROAV
Rating(s) : Input: 12V-24V=== 2.5A Max
Output: 5V=== 4.8A(2.4A Max Per Port)

Test Standard(s) : FCC Part15 Subpart C 2018, Section 15.247

Test Method(s) : ANSI C63.10: 2013, KDB558074 D01 DTS Meas Guidance v05

The device described above is tested by Shenzhen Anbotek Compliance Laboratory Limited to determine the maximum emission levels emanating from the device and the severe levels of the device can endure and its performance criterion. The measurement results are contained in this test report and Shenzhen Anbotek Compliance Laboratory Limited is assumed full of responsibility for the accuracy and completeness of these measurements. Also, this report shows that the EUT (Equipment Under Test) is technically compliant with the FCC Part 15 Subpart C requirements.

This report applies to above tested sample only and shall not be reproduced in part without written approval of Shenzhen Anbotek Compliance Laboratory Limited.

Date of Test

Jul. 24~Dec. 25, 2018

Prepared by



Oliay Yang

(Engineer / Oliay Yang)

Reviewer

Snowy Meng

(Supervisor / Snowy Meng)

Approved & Authorized Signer

Sally Zhang

(Manager / Sally Zhang)

1. General Information

1.1. Client Information

Applicant	:	Anker Innovations Limited
Address	:	Room 1318-19, Hollywood Plaza, 610 Nathan Road, Mongkok, Kowloon, Hong Kong
Manufacturer	:	Anker Innovations Limited
Address	:	Room 1318-19, Hollywood Plaza, 610 Nathan Road, Mongkok, Kowloon, Hong Kong

1.2. Description of Device (EUT)

Product Name	:	Roav Bolt
Model No.	:	R5360
Trade Mark	:	ROAV
Test Power Supply	:	DC 12V/24V/ DC 5V by USB Port
Test Sample No.	:	S1(Normal Sample), S2(Engineering Sample)
Product Description	Operation Frequency:	2402MHz-2480MHz
	Transfer Rate:	1 Mbits/s
	Number of Channel:	40 Channel
	Modulation Type:	GFSK
	Antenna Type:	PCB Antenna
	Antenna Gain(Peak):	0 dBi
<p>Remark: 1)For a more detailed features description, please refer to the manufacturer’s specifications or the User’s Manual. 2)This report is for BT 4.1 (BLE) module.</p>		

1.3. Auxiliary Equipment Used During Test

N/A	
-----	--

1.4. Description of Test Modes

To investigate the maximum EMI emission characteristics generates from EUT, the test system was pre-scanning tested base on the consideration of following EUT operation mode or test configuration mode which possible have effect on EMI emission level. Each of these EUT operation mode(s) or test configuration mode(s) mentioned above was evaluated respectively.

Pretest Mode	Description
Mode 1	CH00
Mode 2	CH19
Mode 3	CH39
Mode 4	Keeping TX+Charging mode

For Conducted Emission	
Final Test Mode	Description
Mode 4	Keeping TX+Charging mode

For Radiated Emission	
Final Test Mode	Description
Mode 1	CH00
Mode 2	CH19
Mode 3	CH39
Mode 4	Keeping TX+Charging mode

Note:

- (1) The measurements are performed at the highest, middle, lowest available channels.
- (2)The data rate was set in 1Mbps for radiated emission due to the highest RF output power.

1.5. List of channels

Channel	Freq. (MHz)	Channel	Freq. (MHz)	Channel	Freq. (MHz)	Channel	Freq. (MHz)	Channel	Freq. (MHz)
00	2402	09	2420	18	2438	27	2456	36	2474
01	2404	10	2422	19	2440	28	2458	37	2476
02	2406	11	2424	20	2442	29	2460	38	2478
03	2408	12	2426	21	2444	30	2462	39	2480
04	2410	13	2428	22	2446	31	2464		
05	2412	14	2430	23	2448	32	2466		
06	2414	15	2432	24	2450	33	2468		
07	2416	16	2434	25	2452	34	2470		
08	2418	17	2436	26	2454	35	2472		

Note:

1. The engineering test program was provided and the EUT was programmed to be in continuously transmitting mode.
2. EUT built-in battery-powered, fully-charged battery use of the test battery.

1.6. Description Of Test Setup

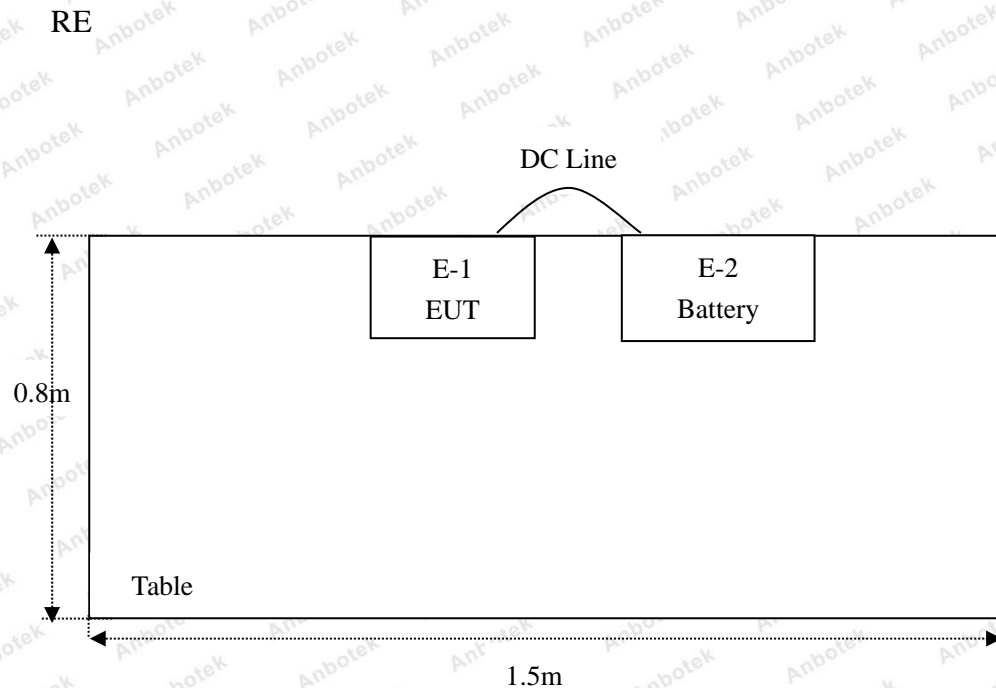

1.7. Test Equipment List

Item	Equipment	Manufacturer	Model No.	Serial No.	Last Cal.	Cal. Interval
1.	L.I.S.N. Artificial Mains Network	Rohde & Schwarz	ENV216	100055	Nov. 05, 2018	1 Year
2.	EMI Test Receiver	Rohde & Schwarz	ESPI3	101604	Nov. 05, 2018	1 Year
3.	RF Switching Unit	Compliance Direction	RSU-M2	38303	Nov. 05, 2018	1 Year
4.	Spectrum Analysis	Agilent	E4407B	US39390582	Nov. 05, 2018	1 Year
5.	MAX Spectrum Analysis	Agilent	N9020A	MY51170037	Nov. 05, 2018	1 Year
6.	Preamplifier	SKET Electronic	BK1G18G30D	KD17503	Nov. 05, 2018	1 Year
7.	Double Ridged Horn Antenna	Instruments corporation	GTH-0118	351600	Nov. 20, 2018	1 Year
8.	Bilog Broadband Antenna	Schwarzbeck	VULB9163	VULB 9163-289	Nov. 19, 2018	1 Year
9.	Loop Antenna	Schwarzbeck	FMZB1519B	00053	Nov. 20, 2018	1 Year
10.	Horn Antenna	A-INFO	LB-180400-K F	J211060628	Nov. 20, 2018	1 Year
11.	Pre-amplifier	SONOMA	310N	186860	Nov. 05, 2018	1 Year
12.	EMI Test Software EZ-EMC	SHURPLE	N/A	N/A	N/A	N/A
13.	RF Test Control System	YIHENG	YH3000	2017430	Nov. 05, 2018	1 Year
14.	Power Sensor	DAER	RPR3006W	15I00041SN045	Nov. 05, 2018	1 Year
15.	Power Sensor	DAER	RPR3006W	15I00041SN046	Nov. 05, 2018	1 Year
16.	MXA Spectrum Analysis	Agilent	N9020A	MY51170037	Nov. 05, 2018	1 Year
17.	MXG RF Vector Signal Generator	Agilent	N5182A	MY48180656	Nov. 05, 2018	1 Year
18.	Signal Generator	Agilent	E4421B	MY41000743	Nov. 05, 2018	1 Year
19.	DC Power Supply	IVYTECH	IV3605	1804D360510	Apr. 02, 2018	1 Year
20.	Constant Temperature Humidity Chamber	ZHONGJIAN	ZJ-KHWS80B	N/A	Nov. 01, 2018	1 Year

1.8. Measurement Uncertainty

Radiation Uncertainty	:	Ur = 3.9 dB (Horizontal)
		Ur = 3.8 dB (Vertical)
Conduction Uncertainty	:	Uc = 3.4 dB

1.9. Description of Test Facility

The test facility is recognized, certified, or accredited by the following organizations:

FCC-Registration No.: 184111

Shenzhen Anbotek Compliance Laboratory Limited, EMC Laboratory has been registered and fully described in a report filed with the (FCC) Federal Communications Commission. The acceptance letter from the FCC is maintained in our files. Registration No. 184111, July 31, 2017.

ISED-Registration No.: 8058A-1

Shenzhen Anbotek Compliance Laboratory Limited, EMC Laboratory has been registered and fully described in a report filed with the (ISED) Innovation, Science and Economic Development Canada. The acceptance letter from the ISED is maintained in our files. Registration 8058A-1, June 13, 2016.

Test Location

Shenzhen Anbotek Compliance Laboratory Limited.

1/F, Building D, Sogood Science and Technology Park, Sanwei community, Hangcheng Street, Bao'an District, Shenzhen, Guangdong, China.518102

2. Summary of Test Results

Standard Section	Test Item	Result
15.203/15.247(c)	Antenna Requirement	PASS
15.207	Conducted Emission	N/A
15.205/15.209	Spurious Emission	PASS
15.247(b)(3)	Conducted Peak Output Power	PASS
15.247(a)(2)	6dB Occupied Bandwidth	PASS
15.247(e)	Power Spectral Density	PASS
15.247(d)	Band Edge	PASS
Remark: "N/A" is an abbreviation for Not Applicable.		

3. Conducted Emission Test

3.1. Test Standard and Limit

Test Standard	FCC Part15 Section 15.207		
Test Limit	Frequency	Maximum RF Line Voltage (dBuV)	
		Quasi-peak Level	Average Level
	150kHz~500kHz	66 ~ 56 *	56 ~ 46 *
	500kHz~5MHz	56	46
5MHz~30MHz	60	50	

Remark: (1) *Decreasing linearly with logarithm of the frequency.
(2) The lower limit shall apply at the transition frequency.

3.2. Test Setup

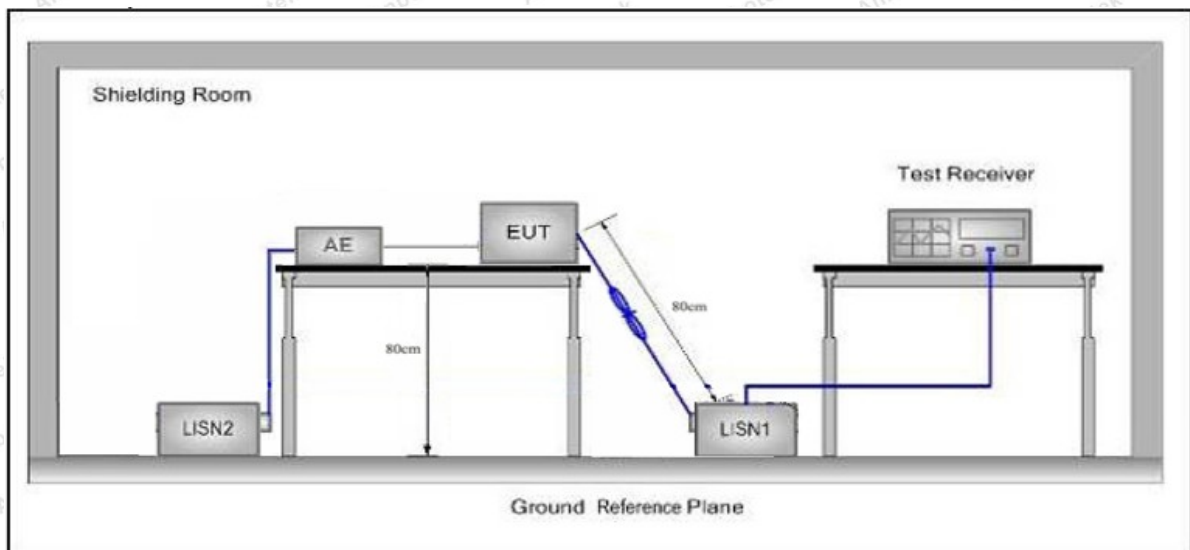

3.3. Test Procedure

The EUT system is connected to the power mains through a line impedance stabilization network (L.I.S.N.). This provides a 50ohm coupling impedance for the EUT system. Please refer the block diagram of the test setup and photographs. Both sides of AC line are checked to find out the maximum conducted emission. In order to find the maximum emission levels, the relative positions of equipment and all of the interface cables shall be changed according to FCC ANSI C63.10-2013 on Conducted Emission Measurement.

The bandwidth of test receiver (ESCI) set at 9kHz.

The frequency range from 150kHz to 30MHz is checked.

3.4. Test Data

The EUT is powered DC 12V/24V, so there is no need to conduct this test.

4. Radiation Spurious Emission and Band Edge

4.1. Test Standard and Limit

Test Standard	FCC Part15 C Section 15.209 and 15.205				
Test Limit	Frequency (MHz)	Field strength (microvolt/meter)	Limit (dBuV/m)	Remark	Measurement distance (m)
	0.009MHz~0.490MHz	2400/F(kHz)	-	-	300
	0.490MHz-1.705MHz	24000/F(kHz)	-	-	30
	1.705MHz-30MHz	30	-	-	30
	30MHz~88MHz	100	40.0	Quasi-peak	3
	88MHz~216MHz	150	43.5	Quasi-peak	3
	216MHz~960MHz	200	46.0	Quasi-peak	3
	960MHz~1000MHz	500	54.0	Quasi-peak	3
	Above 1000MHz	500	54.0	Average	3
-		-	74.0	Peak	3

Remark:

(1)The lower limit shall apply at the transition frequency.

(2) 15.35(b), Unless otherwise specified, the limit on peak radio frequency emissions is 20dB above the maximum permitted average emission limit applicable to the equipment under test. This peak limit applies to the total peak emission level radiated by the device.

4.2. Test Setup

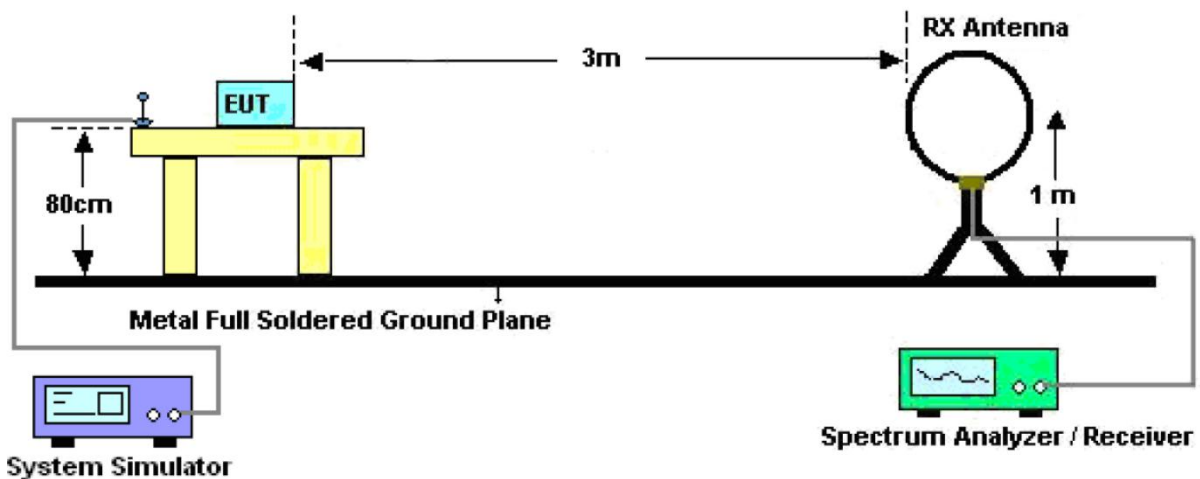

Figure 1. Below 30MHz

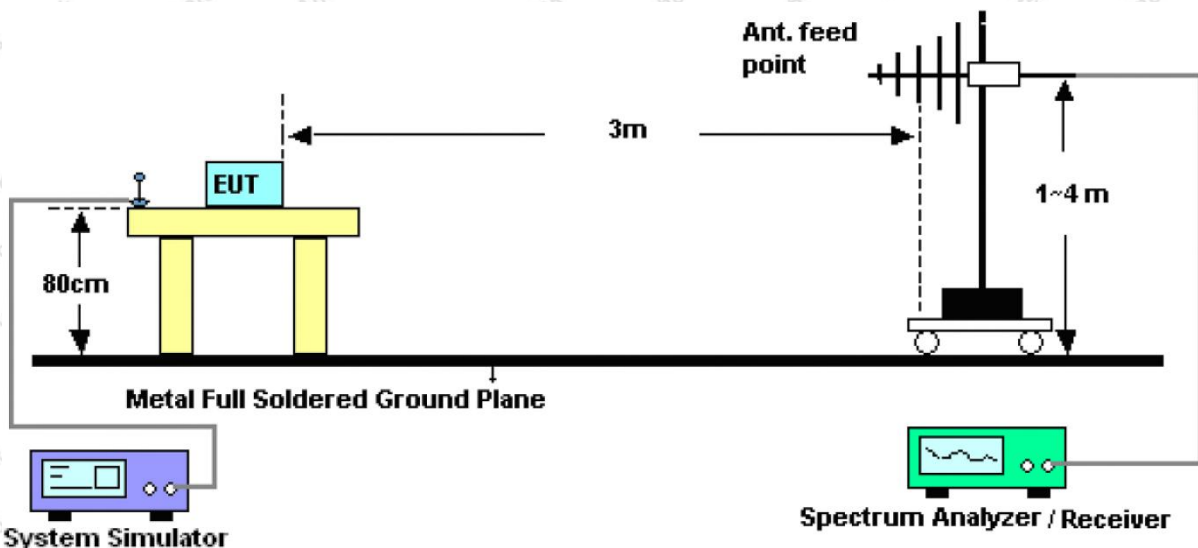

Figure 2. 30MHz to 1GHz

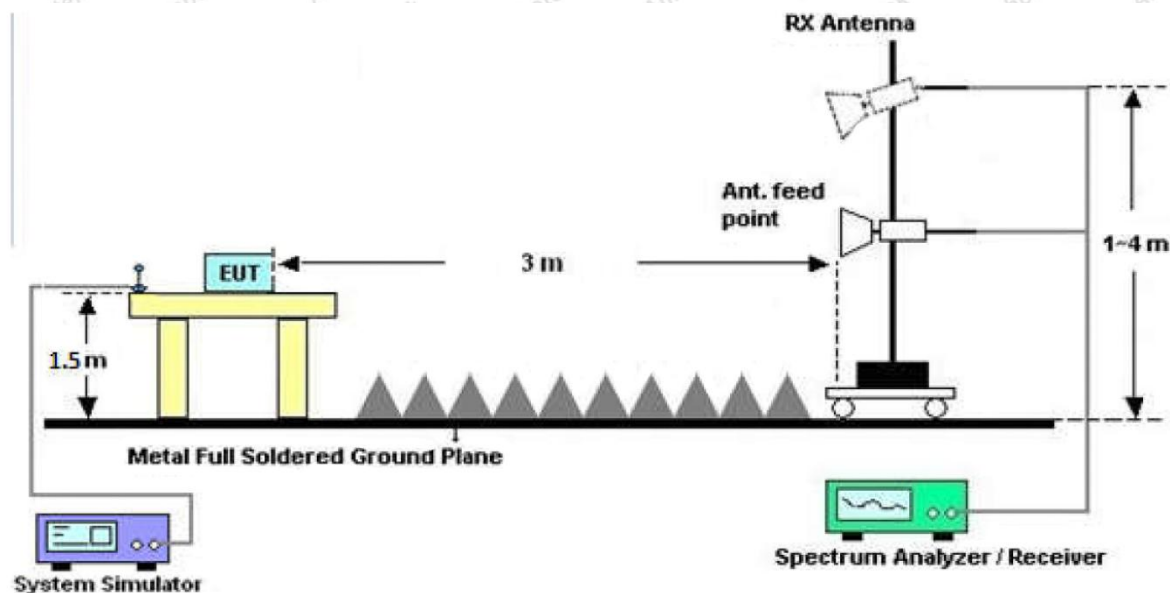

Figure 3. Above 1 GHz

4.3. Test Procedure

For below 1GHz: The EUT is placed on a turntable, which is 0.8m above the ground plane.

For above 1GHz: The EUT is placed on a turntable, which is 1.5m above the ground plane.

The turn table can rotate 360 degrees to determine the position of the maximum emission level. The EUT is set 3 meters away from the receiving antenna which is mounted on a antenna tower. The antenna can be moved up and down from 1 to 4 meters to find out the maximum emission level. Rotated the EUT through three orthogonal axes to determine the maximum emissions, both horizontal and vertical polarization of the antenna are set on test. The EUT is tested in 9*6*6 Chamber. The device is evaluated in xyz orientation.

For the radiated emission test above 1GHz:

Place the measurement antenna away from each area of the EUT determined to be a source of emissions at the specified measurement distance, while keeping the measurement antenna aimed at the source of emissions at each frequency of significant emissions, with polarization oriented for maximum response. The measurement antenna may have to be higher or lower than the EUT, depending on the radiation pattern of the emission and staying

aimed at the emission source for receiving the maximum signal. The final measurement antenna elevation shall be that which maximizes the emissions. The measurement antenna elevation for maximum emissions shall be restricted to a range of heights of from 1 m to 4 m above the ground or reference ground plane.

For 9kHz to 150kHz, Set the spectrum analyzer as:

RBW = 200Hz, VBW = 1kHz, Detector = Quasi-Peak, Trace mode = Max hold, Sweep = auto couple.

For 150kHz to 30MHz, Set the spectrum analyzer as:

RBW = 9kHz, VBW = 30kHz, Detector = Quasi-Peak, Trace mode = Max hold, Sweep = auto couple.

For 30MHz to 1000MHz, Set the spectrum analyzer as:

RBW = 100kHz, VBW = 300kHz, Detector = Quasi-Peak, Trace mode = Max hold, Sweep = auto couple.

For above 1GHz, Set the spectrum analyzer as:

RBW = 1MHz, VBW = 1MHz, Detector = Peak, Trace mode = Max hold, Sweep = auto couple.

RBW = 1MHz, VBW = 10Hz, Detector = Average, Trace mode = Max hold, Sweep = auto couple.

4.4. Test Data

PASS

During the test, Pre-scan all kind of the place mode (X-axis, Y-axis, Z-axis), and found the X-axis is the worst case.

The test results of 9kHz-30MHz was attenuated more than 20dB below the permissible limits, so the results don't record in the report.

Test Results (30~1000MHz)

Job No.: SZAWW180724007-01 Temp.(°C)/Hum.(%RH): 19.4°C/50%RH
 Standard: FCC PART 15C Power Source: DC 12V
 Test Mode: Keeping TX+ Charging Mode Polarization: Horizontal

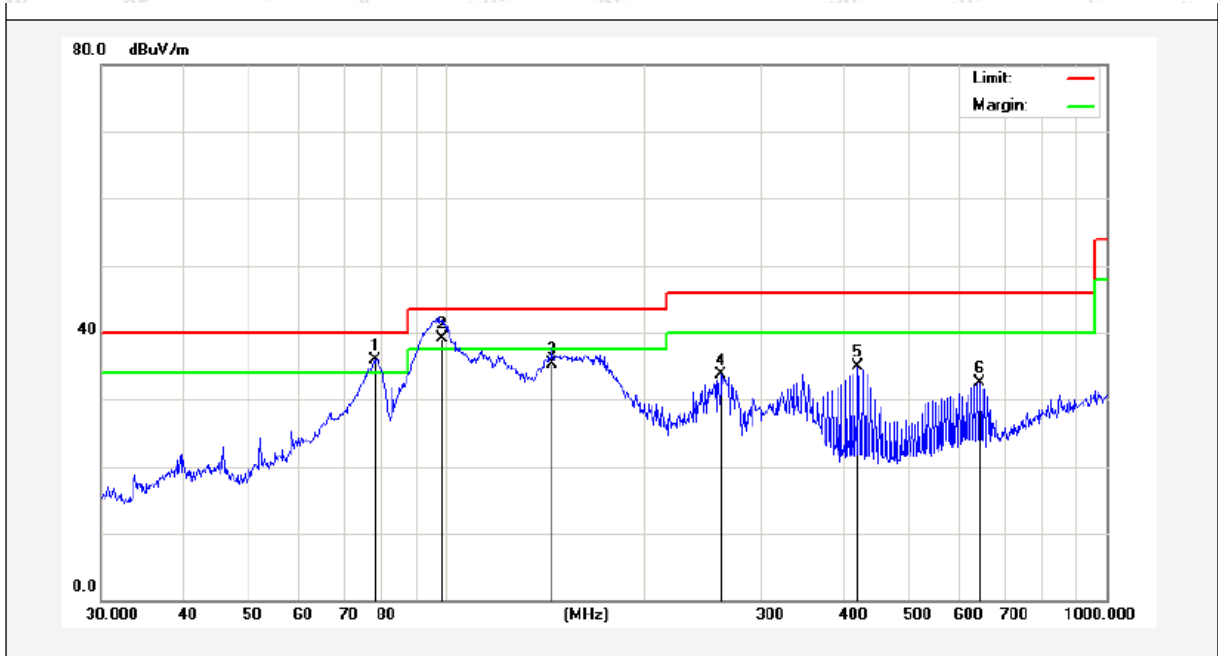

No.	Freq. (MHz)	Reading (dBuV)	Factor (dB/m)	Result (dBuV/m)	Limit (dBuV/m)	Over Limit (dB)	Detector	Height (cm)	degree (deg)	Remark
1	78.1389	59.29	-23.33	35.96	40.00	-4.04	QP	300	132	
2	98.2960	61.10	-21.92	39.18	43.50	-4.32	QP	300	360	
3	144.3348	57.70	-22.43	35.27	43.50	-8.23	QP	300	46	
4	261.0583	53.23	-19.57	33.66	46.00	-12.34	QP	300	240	
5	420.5803	47.24	-12.38	34.86	46.00	-11.14	QP	300	341	
6	642.8613	42.52	-10.05	32.47	46.00	-13.53	QP	300	220	

Test Results (30~1000MHz)

Job No.: SZAWW180724007-01 Temp.(°C)/Hum.(%RH): 19.4°C/50%RH
 Standard: FCC PART 15C Power Source: DC 12V
 Test Mode: Keeping TX+ Charging Mode Polarization: Vertical

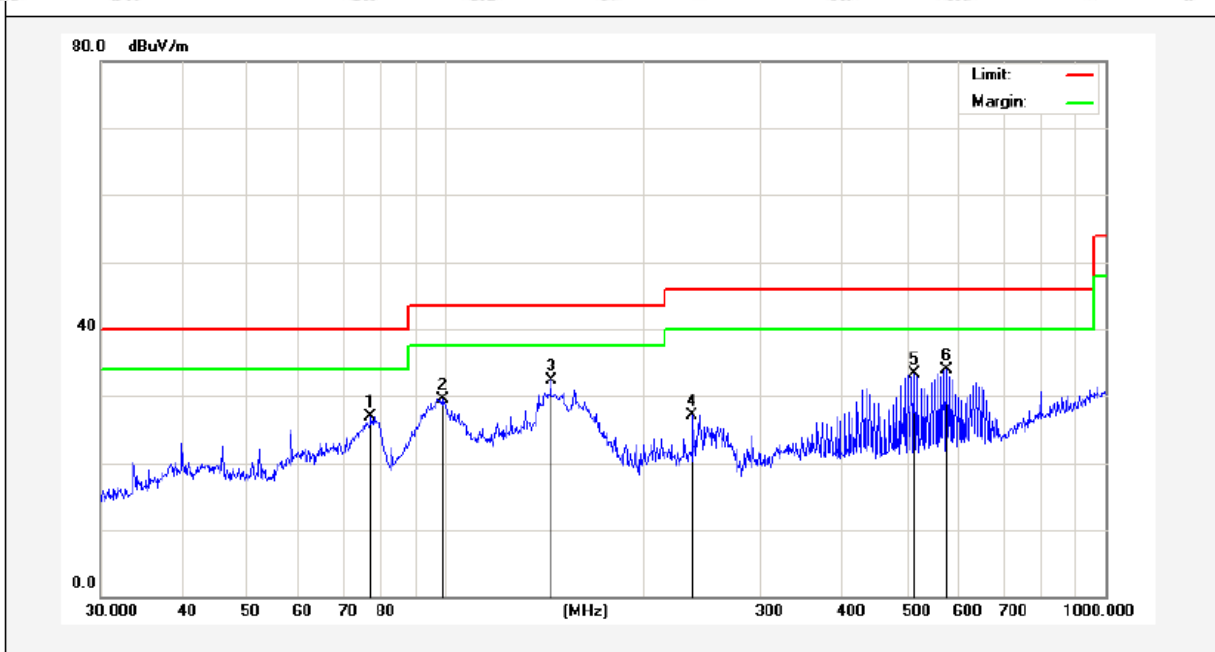

No.	Freq. (MHz)	Reading (dBuV)	Factor (dB/m)	Result (dBuV/m)	Limit (dBuV/m)	Over Limit (dB)	Detector	Height (cm)	degree (deg)	Remark
1	77.0505	48.26	-21.26	27.00	40.00	-13.00	QP	300	125	
2	98.8326	45.40	-15.87	29.53	43.50	-13.97	QP	300	204	
3	144.3348	50.83	-18.43	32.40	43.50	-11.10	QP	300	221	
4	236.6447	41.65	-14.63	27.02	46.00	-18.98	QP	300	147	
5	513.6331	43.93	-10.72	33.21	46.00	-12.79	QP	300	263	
6	574.6258	43.64	-9.67	33.97	46.00	-12.03	QP	300	360	

Test Results (30~1000MHz)

Job No.: SZAWW180724007-01 Temp.(°C)/Hum.(%RH): 19.4°C/50%RH
 Standard: FCC PART 15C Power Source: DC 24V
 Test Mode: Keeping TX+ Charging Mode Polarization: Horizontal

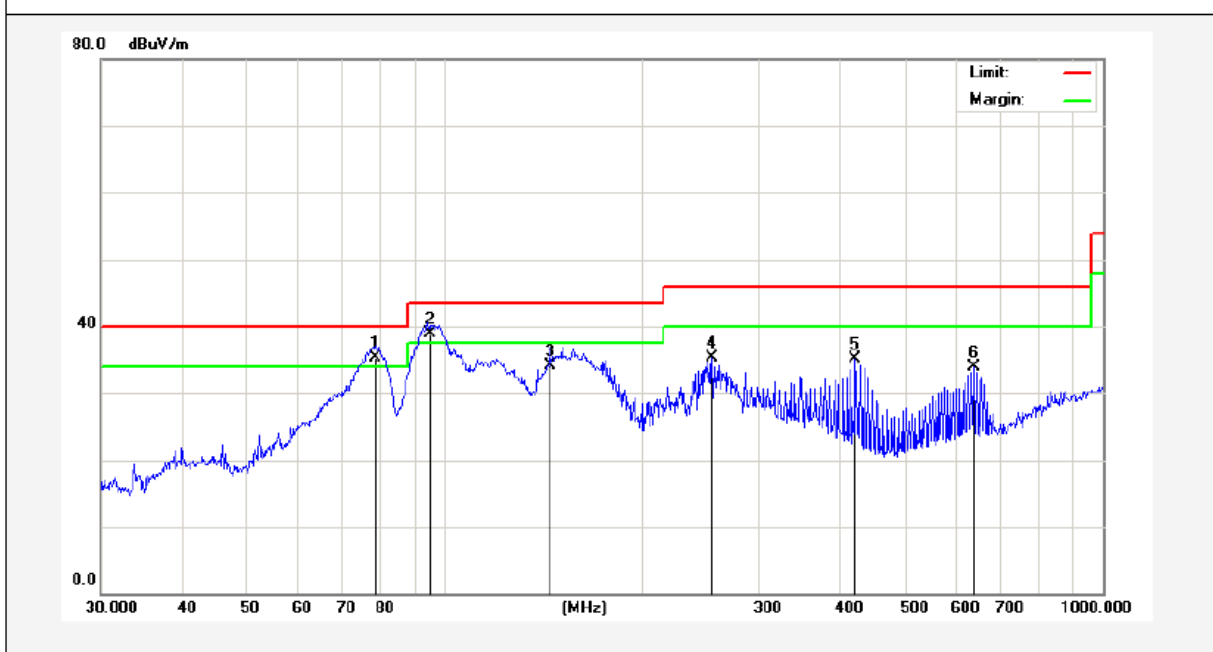

No.	Freq. (MHz)	Reading (dBuV)	Factor (dB/m)	Result (dBuV/m)	Limit (dBuV/m)	Over Limit (dB)	Detector	Height (cm)	degree (deg)	Remark
1	78.4133	58.64	-23.40	35.24	40.00	-4.76	QP	300	25	
2	95.2479	61.15	-22.19	38.96	43.50	-4.54	QP	300	0	
3	144.3348	56.62	-22.43	34.19	43.50	-9.31	QP	300	360	
4	254.7284	54.65	-19.31	35.34	46.00	-10.66	QP	300	201	
5	420.5803	47.54	-12.38	35.16	46.00	-10.84	QP	300	311	
6	636.1340	44.22	-10.24	33.98	46.00	-12.02	QP	300	222	

Test Results (30~1000MHz)

Job No.: SZAWW180724007-01 Temp.(°C)/Hum.(%RH): 19.4°C/50%RH
 Standard: FCC PART 15C Power Source: DC 24V
 Test Mode: Keeping TX+ Charging Mode Polarization: Vertical

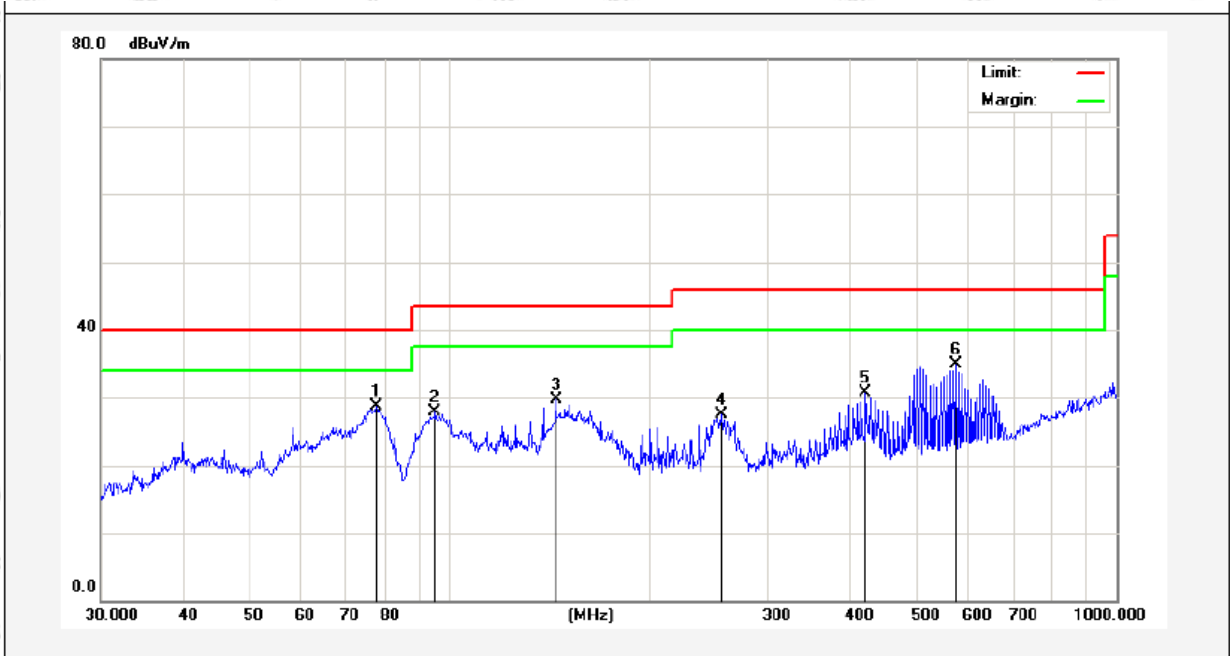

No.	Freq. (MHz)	Reading (dBuV)	Factor (dB/m)	Result (dBuV/m)	Limit (dBuV/m)	Over Limit (dB)	Detector	Height (cm)	degree (deg)	Remark
1	77.5928	49.89	-21.18	28.71	40.00	-11.29	QP	300	152	
2	95.0930	44.06	-16.20	27.86	43.50	-15.64	QP	300	125	
3	144.3348	48.21	-18.43	29.78	43.50	-13.72	QP	300	201	
4	255.6231	42.05	-14.57	27.48	46.00	-18.52	QP	300	321	
5	420.5803	41.92	-11.28	30.64	46.00	-15.36	QP	300	336	
6	574.6258	44.58	-9.67	34.91	46.00	-11.09	QP	300	263	

Test Results (1GHz-25GHz)

Test Mode: CH00					Test channel: Lowest			
Peak Value								
Frequency (MHz)	Read Level (dBuV)	Antenna Factor (dB/m)	Cable Loss (dB)	Preamp Factor (dB)	Level (dBuV/m)	Limit (dBuV/m)	Over Limit (dB)	Pol.
4804.00	38.34	34.04	6.58	34.09	44.87	74.00	-29.13	V
7206.00	32.52	37.11	7.73	34.50	42.86	74.00	-31.14	V
9608.00	32.08	39.31	9.23	34.79	45.83	74.00	-28.17	V
12010.00	*					74.00		V
14412.00	*					74.00		V
4804.00	42.84	34.04	6.58	34.09	49.37	74.00	-24.63	H
7206.00	34.36	37.11	7.73	34.50	44.70	74.00	-29.30	H
9608.00	31.60	39.31	9.23	34.79	45.35	74.00	-28.65	H
12010.00	*					74.00		H
14412.00	*					74.00		H
Average Value								
Frequency (MHz)	Read Level (dBuV)	Antenna Factor (dB/m)	Cable Loss (dB)	Preamp Factor (dB)	Level (dBuV/m)	Limit (dBuV/m)	Over Limit (dB)	Pol.
4804.00	26.96	34.04	6.58	34.09	33.49	54.00	-20.51	V
7206.00	21.09	37.11	7.73	34.50	31.43	54.00	-22.57	V
9608.00	20.10	39.31	9.23	34.79	33.85	54.00	-20.15	V
12010.00	*					54.00		V
14412.00	*					54.00		V
4804.00	31.30	34.04	6.58	34.09	37.83	54.00	-16.17	H
7206.00	23.33	37.11	7.73	34.50	33.67	54.00	-20.33	H
9608.00	19.91	39.31	9.23	34.79	33.66	54.00	-20.34	H
12010.00	*					54.00		H
14412.00	*					54.00		H

Test Results (1GHz-25GHz)

Test Mode: CH19					Test channel: Middle			
Peak Value								
Frequency (MHz)	Read Level (dBuV)	Antenna Factor (dB/m)	Cable Loss (dB)	Preamp Factor (dB)	Level (dBuV/m)	Limit (dBuV/m)	Over Limit (dB)	Pol.
4880.00	36.38	34.38	6.69	34.09	43.36	74.00	-30.64	V
7320.00	31.22	37.22	7.78	34.53	41.69	74.00	-32.31	V
9760.00	30.92	39.46	9.35	34.80	44.93	74.00	-29.07	V
12200.00	*					74.00		V
14640.00	*					74.00		V
4880.00	40.47	34.38	6.69	34.09	47.45	74.00	-26.55	H
7320.00	32.89	37.22	7.78	34.53	43.36	74.00	-30.64	H
9760.00	30.26	39.46	9.35	34.80	44.27	74.00	-29.73	H
12200.00	*					74.00		H
14640.00	*					74.00		H
Average Value								
Frequency (MHz)	Read Level (dBuV)	Antenna Factor (dB/m)	Cable Loss (dB)	Preamp Factor (dB)	Level (dBuV/m)	Limit (dBuV/m)	Over Limit (dB)	Pol.
4880.00	25.38	34.38	6.69	34.09	32.36	54.00	-21.64	V
7320.00	20.01	37.22	7.78	34.53	30.48	54.00	-23.52	V
9760.00	19.15	39.46	9.35	34.80	33.16	54.00	-20.84	V
12200.00	*					54.00		V
14640.00	*					54.00		V
4880.00	29.50	34.38	6.69	34.09	36.48	54.00	-17.52	H
7320.00	22.13	37.22	7.78	34.53	32.60	54.00	-21.40	H
9760.00	18.80	39.46	9.35	34.80	32.81	54.00	-21.19	H
12200.00	*					54.00		H
14640.00	*					54.00		H

Test Results (1GHz-25GHz)

Test Mode: CH39					Test channel: Highest			
Peak Value								
Frequency (MHz)	Read Level (dBuV)	Antenna Factor (dB/m)	Cable Loss (dB)	Preamp Factor (dB)	Level (dBuV/m)	Limit (dBuV/m)	Over Limit (dB)	Pol.
4960.00	36.19	34.72	6.79	34.09	43.61	74.00	-30.39	V
7440.00	31.09	37.34	7.82	34.57	41.68	74.00	-32.32	V
9920.00	30.81	39.62	9.46	34.81	45.08	74.00	-28.92	V
12400.00	*					74.00		V
14880.00	*					74.00		V
4960.00	40.25	34.72	6.79	34.09	47.67	74.00	-26.33	H
7440.00	32.75	37.34	7.82	34.57	43.34	74.00	-30.66	H
9920.00	30.13	39.62	9.46	34.81	44.40	74.00	-29.60	H
12400.00	*					74.00		H
14880.00	*					74.00		H
Average Value								
Frequency (MHz)	Read Level (dBuV)	Antenna Factor (dB/m)	Cable Loss (dB)	Preamp Factor (dB)	Level (dBuV/m)	Limit (dBuV/m)	Over Limit (dB)	Pol.
4960.00	25.27	34.72	6.79	34.09	32.69	54.00	-21.31	V
7440.00	19.94	37.34	7.82	34.57	30.53	54.00	-23.47	V
9920.00	19.08	39.62	9.46	34.81	33.35	54.00	-20.65	V
12400.00	*					54.00		V
14880.00	*					54.00		V
4960.00	29.38	34.72	6.79	34.09	36.80	54.00	-17.20	H
7440.00	22.04	37.34	7.82	34.57	32.63	54.00	-21.37	H
9920.00	18.72	39.62	9.46	34.81	32.99	54.00	-21.01	H
12400.00	*					54.00		H
14880.00	*					54.00		H

Remark:

- Level = Receiver Read level + Antenna Factor + Cable Loss – Preamplifier Factor
- “*” means the test results were attenuated more than 20dB below the permissible limits, so the results don't record in the report.

Radiated Band Edge:

Test Mode: CH00					Test channel: Lowest			
Peak Value								
Frequency (MHz)	Read Level (dBuV)	Antenna Factor (dB/m)	Cable Loss (dB)	Preamp Factor (dB)	Level (dBuV/m)	Limit (dBuV/m)	Over Limit (dB)	Pol.
2390.00	47.64	29.15	3.41	34.01	46.19	74.00	-27.81	H
2400.00	65.10	29.16	3.43	34.01	63.68	74.00	-10.32	H
2390.00	48.64	29.15	3.41	34.01	47.19	74.00	-26.81	V
2400.00	67.65	29.16	3.43	34.01	66.23	74.00	-7.77	V
Average Value								
Frequency (MHz)	Read Level (dBuV)	Antenna Factor (dB/m)	Cable Loss (dB)	Preamp Factor (dB)	Level (dBuV/m)	Limit (dBuV/m)	Over Limit (dB)	Pol.
2390.00	37.11	29.15	3.41	34.01	35.66	54.00	-18.34	H
2400.00	48.63	29.16	3.43	34.01	47.21	54.00	-6.79	H
2390.00	37.39	29.15	3.41	34.01	35.94	54.00	-18.06	V
2400.00	45.73	29.16	3.43	34.01	44.31	54.00	-9.69	V

Test Mode: CH39					Test channel: Highest			
Peak Value								
Frequency (MHz)	Read Level (dBuV)	Antenna Factor (dB/m)	Cable Loss (dB)	Preamp Factor (dB)	Level (dBuV/m)	Limit (dBuV/m)	Over Limit (dB)	Pol.
2483.50	50.31	29.28	3.53	34.03	49.09	74.00	-24.91	H
2500.00	48.57	29.30	3.56	34.03	47.40	74.00	-26.60	H
2483.50	51.94	29.28	3.53	34.03	50.72	74.00	-23.28	V
2500.00	50.02	29.30	3.56	34.03	48.85	74.00	-25.15	V
Average Value								
Frequency (MHz)	Read Level (dBuV)	Antenna Factor (dB/m)	Cable Loss (dB)	Preamp Factor (dB)	Level (dBuV/m)	Limit (dBuV/m)	Over Limit (dB)	Pol.
2483.50	39.99	29.28	3.53	34.03	38.77	54.00	-15.23	H
2500.00	37.32	29.30	3.56	34.03	36.15	54.00	-17.85	H
2483.50	41.60	29.28	3.53	34.03	40.38	54.00	-13.62	V
2500.00	37.63	29.30	3.56	34.03	36.46	54.00	-17.54	V

Remark:

1. Level = Receiver Read level + Antenna Factor + Cable Loss – Preamplifier Factor

5. Maximum Peak Output Power Test

5.1. Test Standard and Limit

Test Standard	FCC Part15 C Section 15.247 (b)(3)
Test Limit	30dBm

5.2. Test Setup

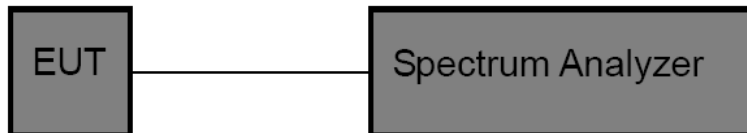

5.3. Test Procedure

This procedure shall be used when the measurement instrument has available a resolution bandwidth that is greater than the DTS bandwidth.

1. Set the RBW \geq DTS bandwidth.
2. Set the VBW \geq 3*RBW.
3. Set the span \geq 3*RBW.
4. Detector = peak.
5. Sweep time = auto couple.
6. Trace mode = max hold.
7. Allow trace to fully stabilize.
8. Use peak marker function to determine the peak amplitude level.

5.4. Test Data

Test Item : Max. peak output power
 Test Voltage : DC 5V by USB Port
 Test Result : PASS

Test Mode : CH Low ~ CH High
 Temperature : 24°C
 Humidity : 55%RH

Channel Frequency (MHz)	Peak Power output (dBm)	Limit (dBm)	Results
2402	9.274	30	PASS
2440	9.818	30	PASS
2480	9.522	30	PASS

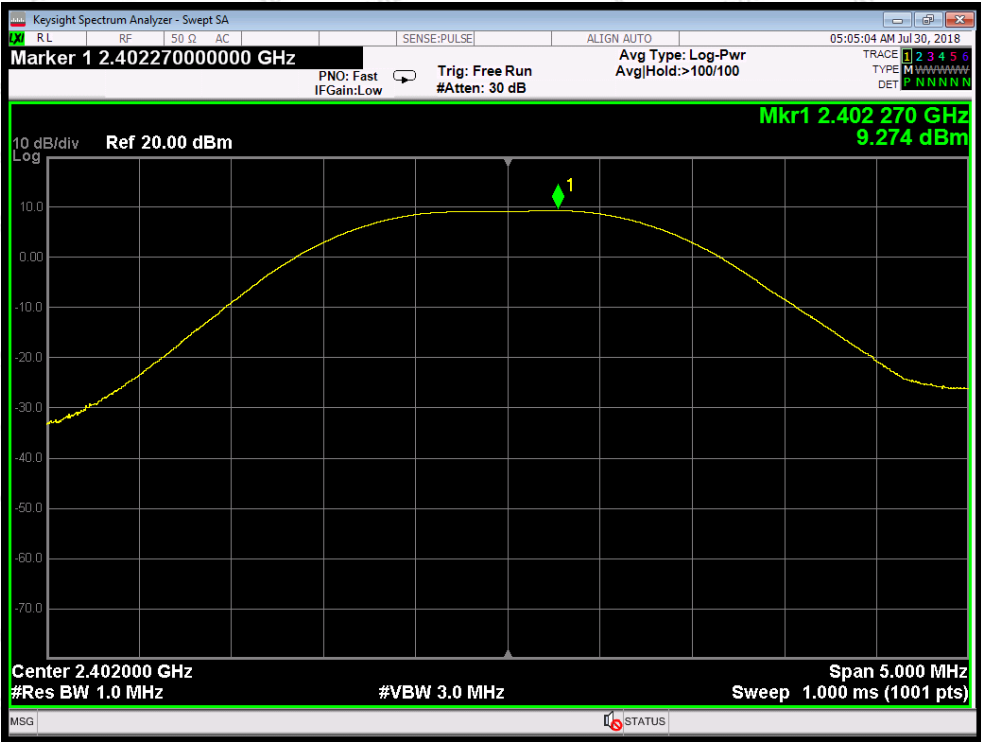

CH: Low

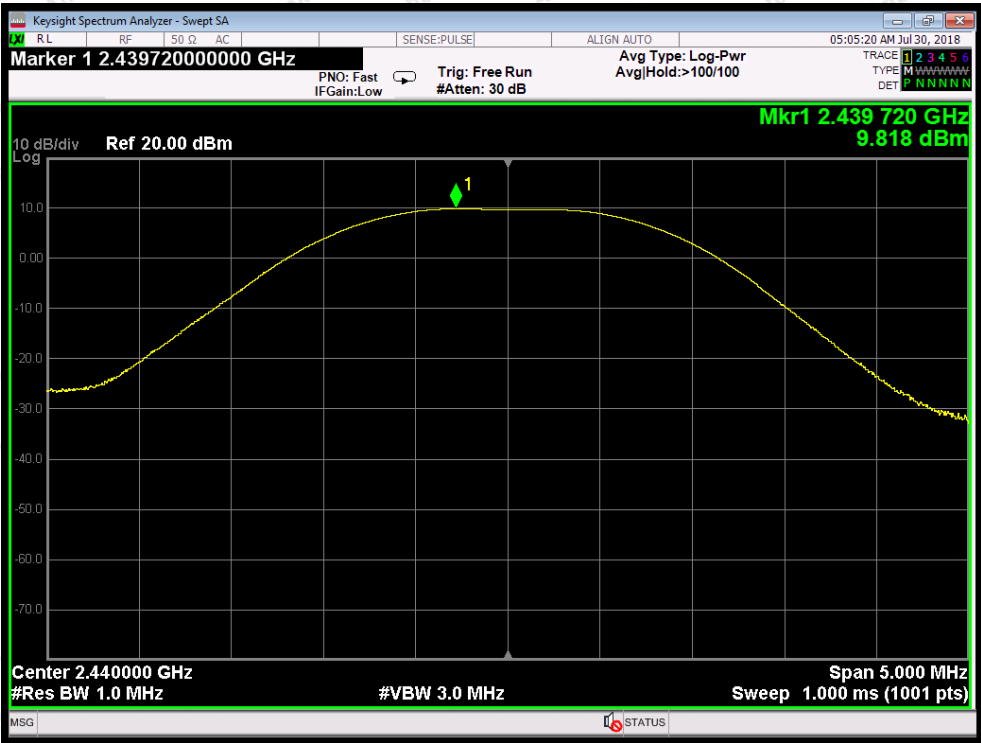

CH: Middle

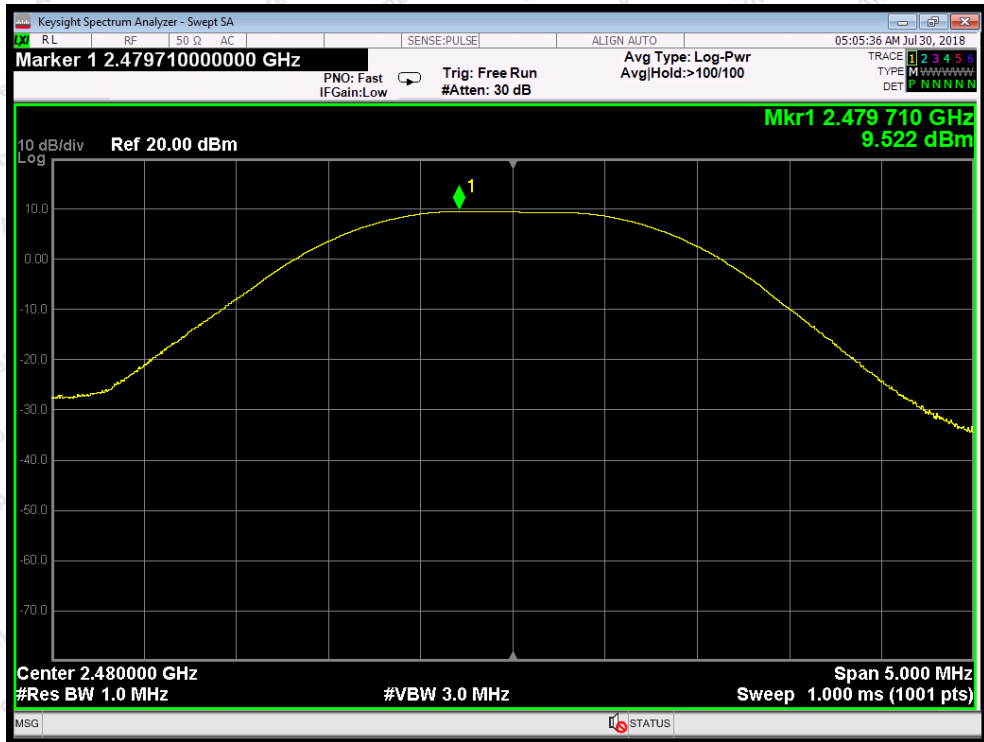

CH: High

6. 6dB Occupy Bandwidth Test

6.1. Test Standard and Limit

Test Standard	FCC Part 15 C Section 15.247 (a)(2)
Test Limit	>500kHz

6.2. Test Setup

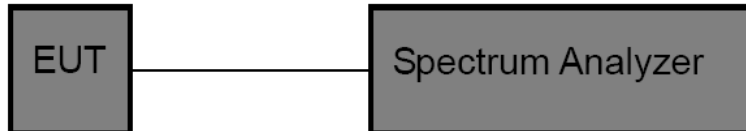

6.3. Test Procedure

1. Place the EUT on the table and set it in the transmitting mode.
2. Remove the antenna from the EUT and then connect a low loss RF cable from the antenna port to the spectrum analyzer.
3. Set the spectrum analyzer as:
 RBW = 100kHz, VBW ≥ 3*RBW = 300kHz,
 Detector = Peak
 Trace mode = Max hold.
 Sweep = auto couple.
4. Mark the peak frequency and -6dB (upper and lower) frequency.
5. Repeat until all the rest channels are investigated.

6.4. Test Data

Test Item : 6dB Bandwidth
 Test Voltage : DC 5V by USB Port
 Test Result : PASS

Test Mode : CH Low ~ CH High
 Temperature : 24°C
 Humidity : 55% RH

Channel	Frequency(MHz)	Bandwidth (kHz)	Limit (kHz)	Results
Low	2402	706.6	>500	PASS
Middle	2440	700.5		PASS
High	2480	705.7		PASS

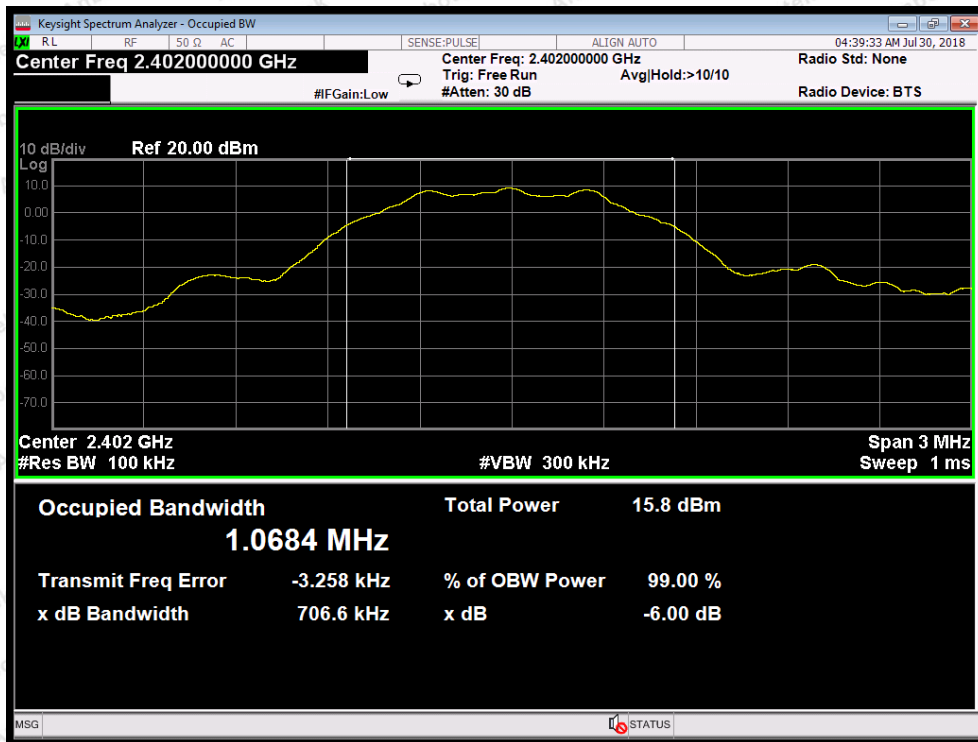

CH: Low

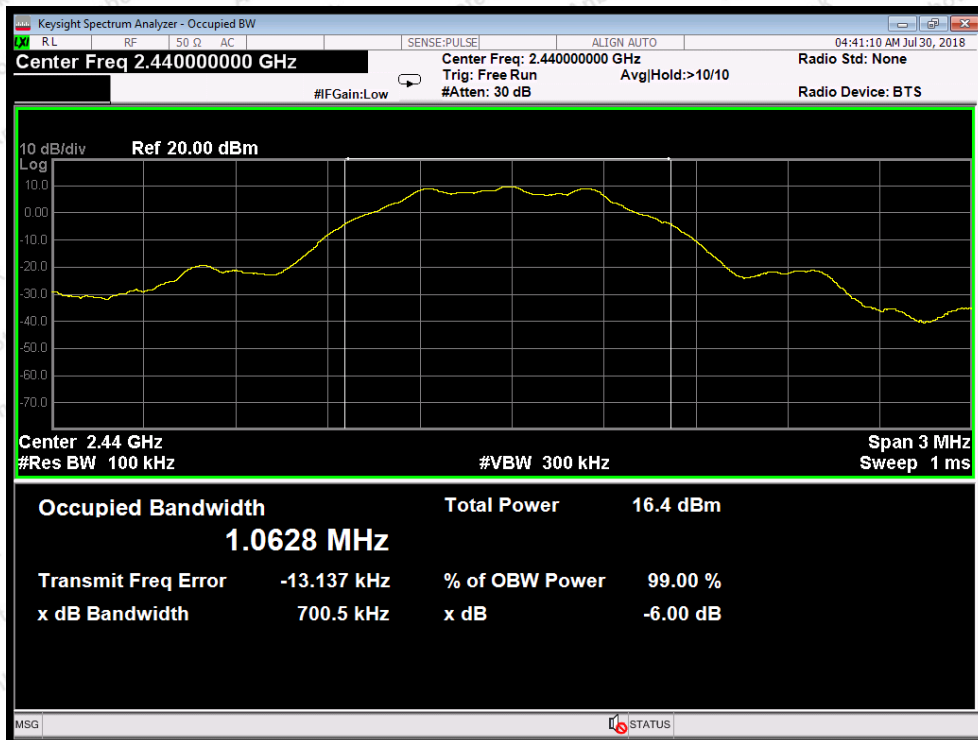

CH: Middle

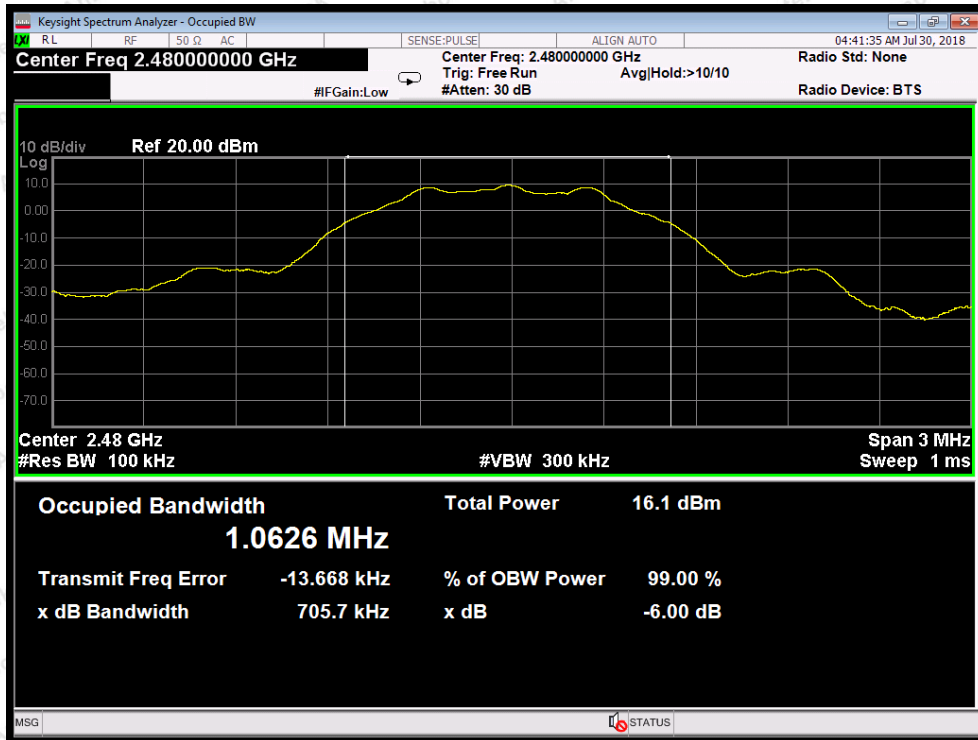

CH: High

7. Power Spectral Density Test

7.1. Test Standard and Limit

Test Standard	FCC Part15 C Section 15.247 (e)
Test Limit	8dBm

7.2. Test Setup

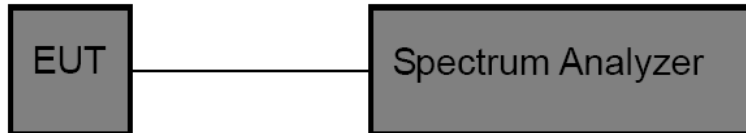

7.3. Test Procedure

1. Place the EUT on the table and set it in transmitting mode. Remove the antenna from the EUT and then connect a low loss RF cable from the antenna port to the spectrum analyzer.
2. Set the spectrum analyzer as RBW = 3kHz, VBW = 10kHz, Span = 1.5xDTS BW
3. Record the max. reading.
4. Repeat the above procedure until the measurements for all frequencies are completed.

7.4. Test Data

Test Item : Power Spectral Density
 Test Voltage : DC 5V by USB Port
 Test Result : PASS

Test Mode : CH Low ~ CH High
 Temperature : 24°C
 Humidity : 55%RH

Channel	Frequency (MHz)	PSD (dBm/3KHz)	Limit (dBm/3KHz)	Results
Low	2402	-6.394	8.00	PASS
Middle	2440	-5.791	8.00	PASS
High	2480	-6.032	8.00	PASS

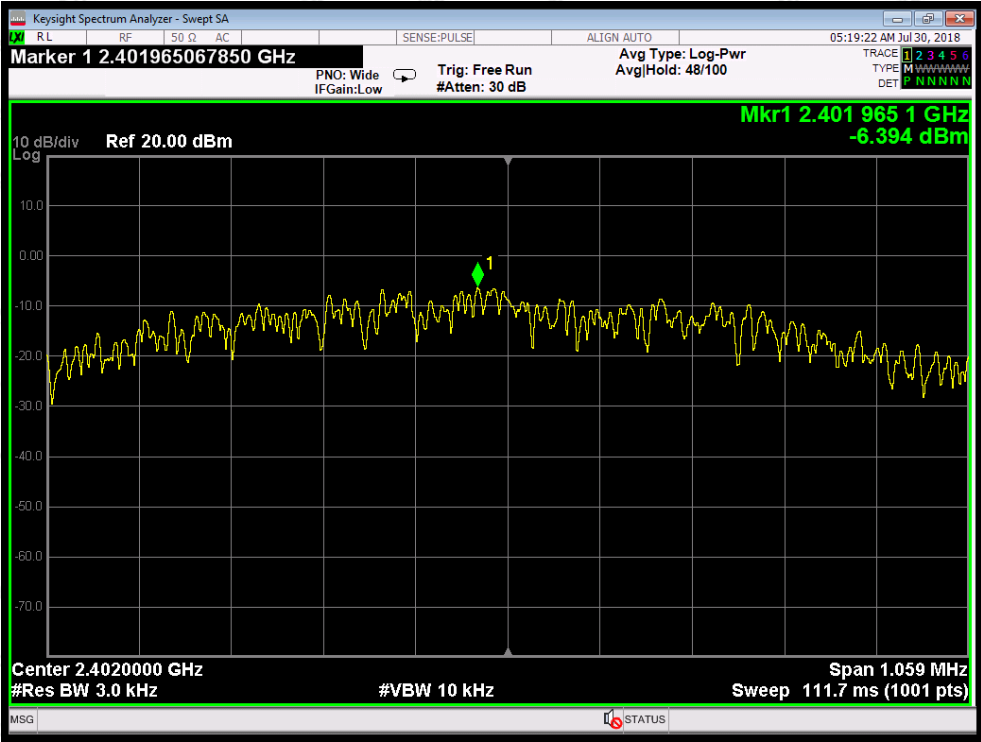

CH: Low

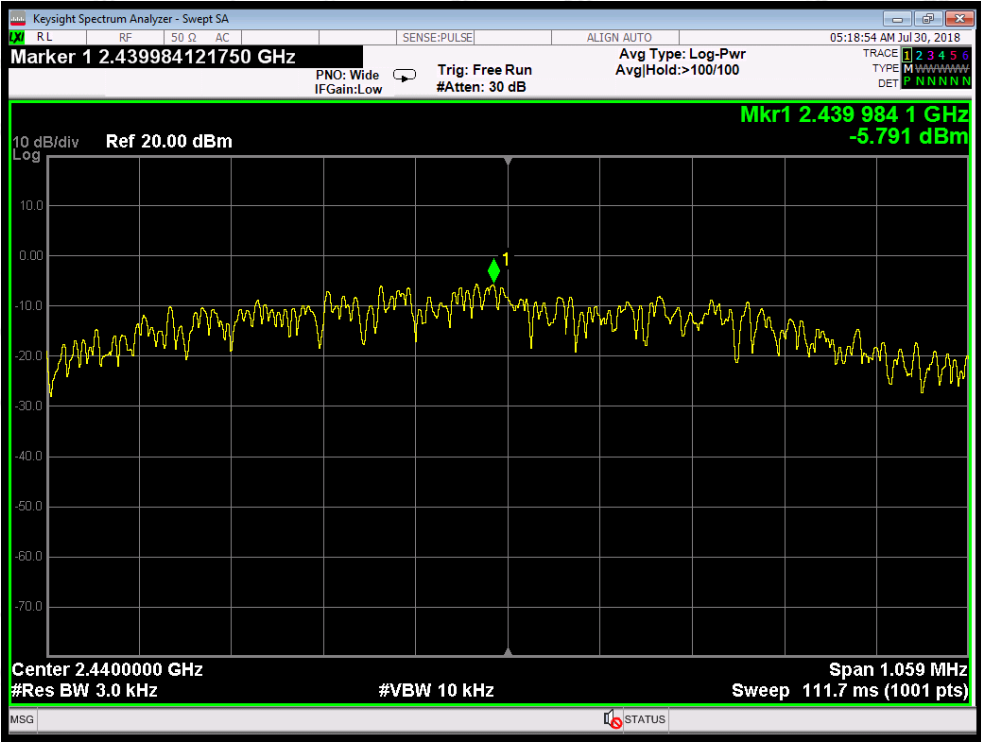

CH: Middle

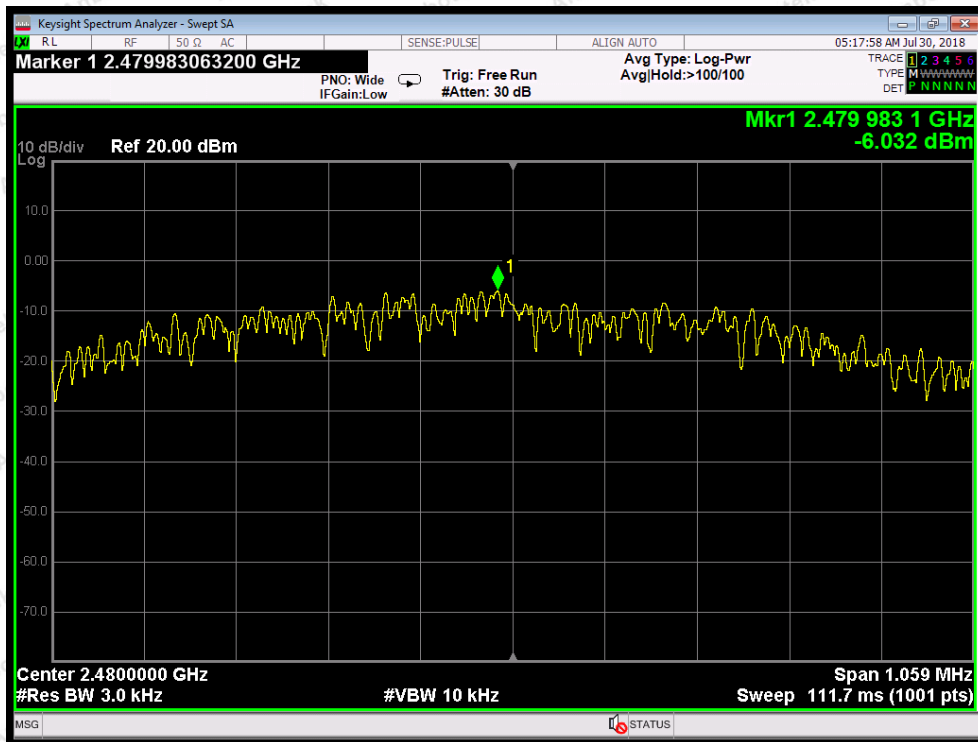

CH: High

8. 100kHz Bandwidth of Frequency Band Edge Requirement

8.1. Test Standard and Limit

Test Standard	FCC Part15 C Section 15.247 (d)
Test Limit	in any 100 kHz bandwidth outside the frequency bands in which the spread spectrum intentional radiator is operating, the radio frequency power that is produced by the intentional radiator shall be at least 20dB below that in the 100kHz bandwidth within the band that contains the highest level of the desired power, In addition, radiated emissions which fall in the restricted bands, as defined in §15.205(a), must also comply with the radiated emission limits specified in15.209(a).

8.2. Test Setup

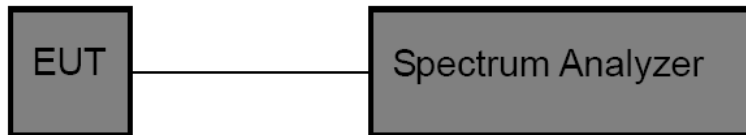

8.3. Test Procedure

Using the following spectrum analyzer setting:

1. Set the RBW = 100KHz.
2. Set the VBW = 300KHz.
3. Sweep time = auto couple.
4. Detector function = peak.
5. Trace mode = max hold.
6. Allow trace to fully stabilize.

8.4. Test Data

Test Item	: Band edge	Test Mode	: CH Low ~ CH High
Test Voltage	: DC 5V by USB Port	Temperature	: 24°C
Test Result	: PASS	Humidity	: 55%RH

Frequency Band (MHz)	Delta Peak to Band Emission (dBc)	Limit (dBc)	Results
2400	45.315	>20	PASS
2483.5	60.266	>20	PASS

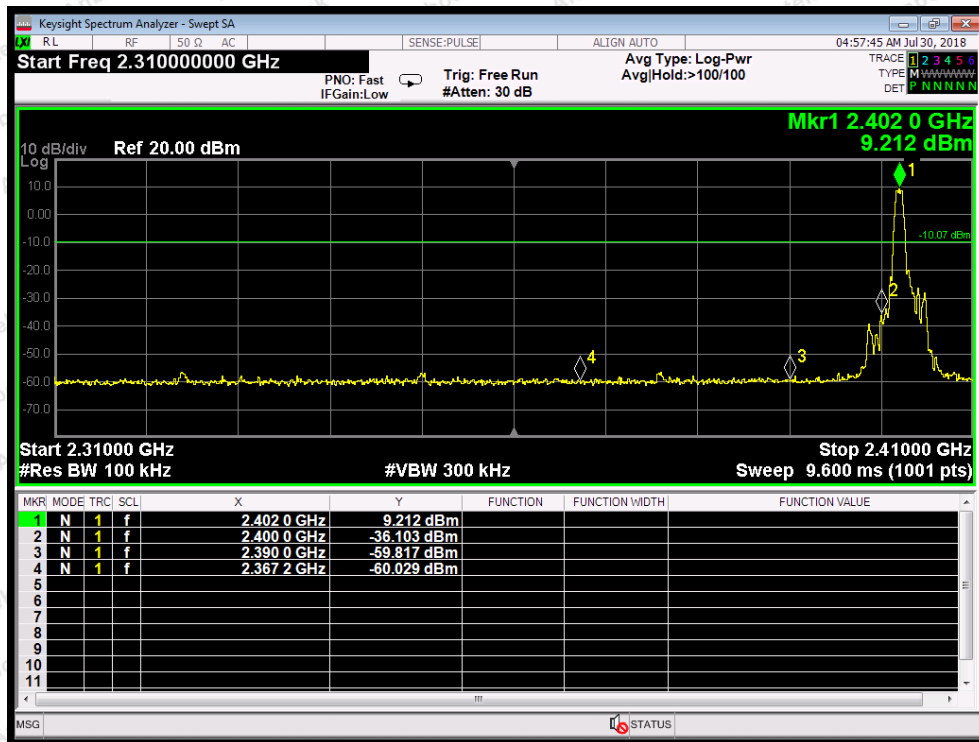

CH: Low

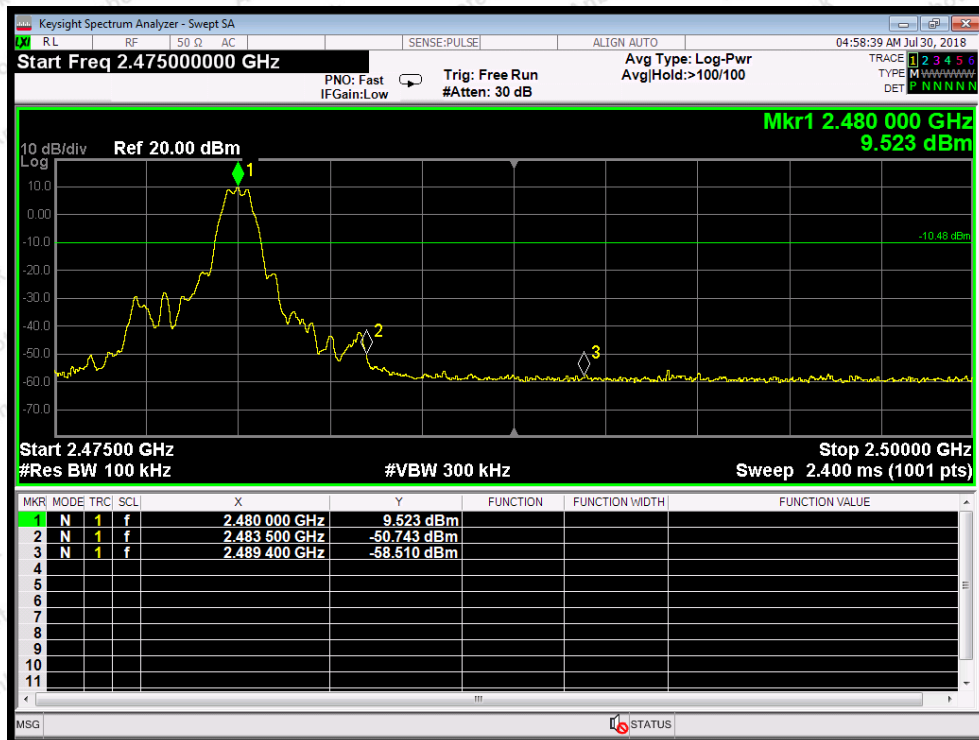

CH: High

Conducted Emission Method

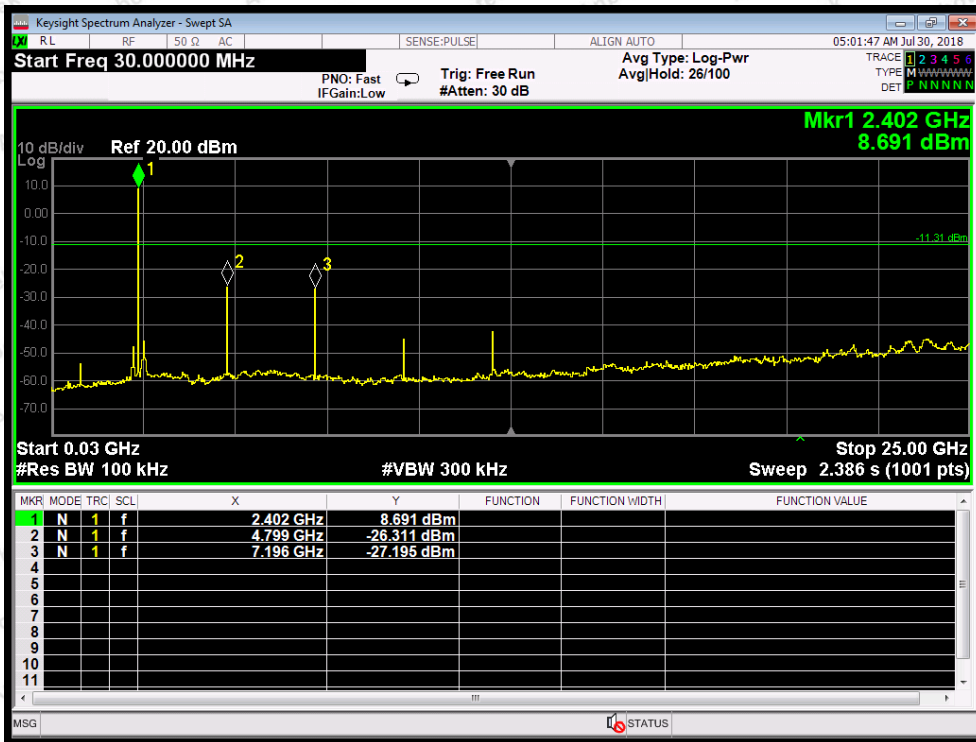

CH: Low

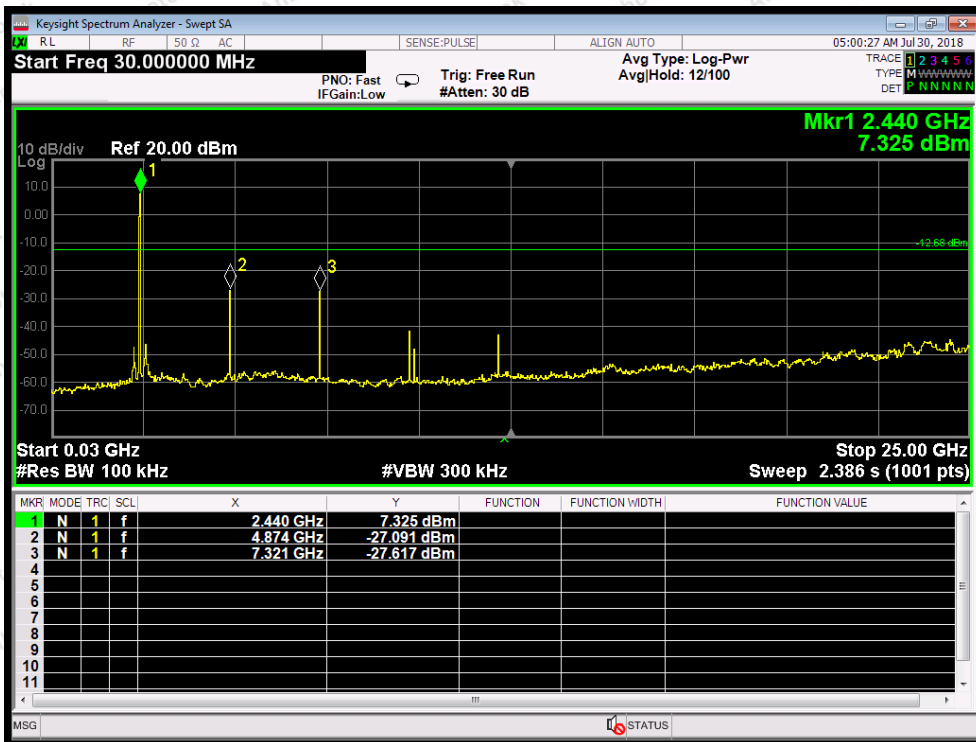

CH: Middle

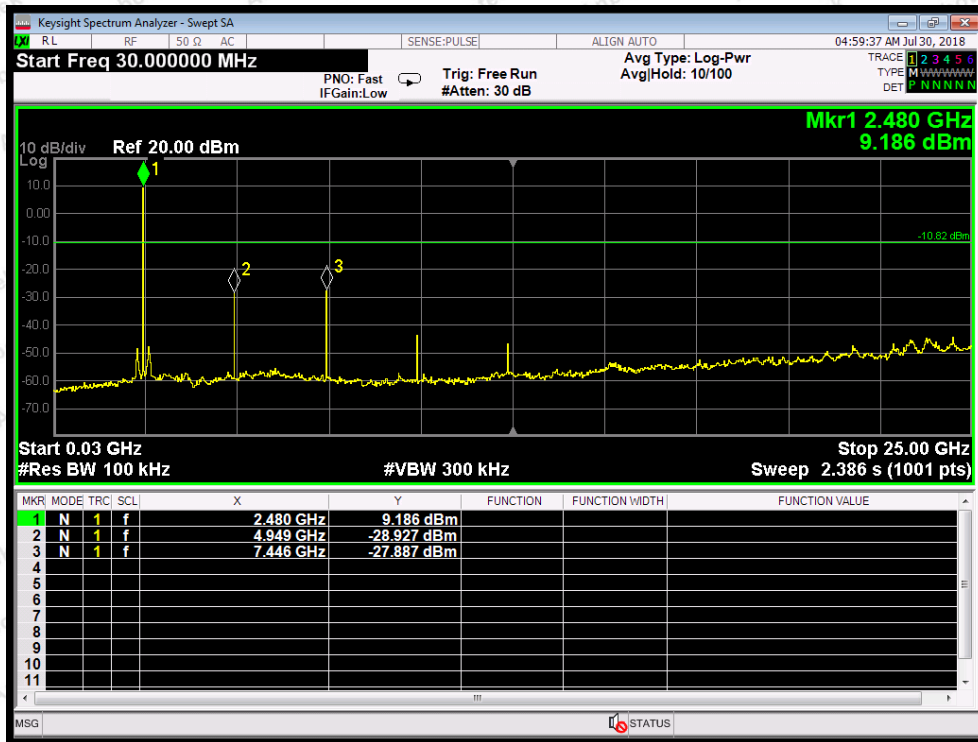

CH: High

9. Antenna Requirement

9.1. Test Standard and Requirement

Test Standard	FCC Part15 Section 15.203 /247(c)
Requirement	<p>1) 15.203 requirement: An intentional radiator shall be designed to ensure that no antenna other than that furnished by the responsible party shall be used with the device. The use of a permanently attached antenna or of an antenna that uses a unique coupling to the intentional radiator, the manufacturer may design the unit so that a broken antenna can be replaced by the user, but the use of a standard antenna jack or electrical connector is prohibited.</p> <p>2) 15.247(c) (1)(i) requirement: Systems operating in the 2400-2483.5 MHz band that is used exclusively for fixed. Point-to-point operations may employ transmitting antennas with directional gain greater than 6dBi provided the maximum conducted output power of the intentional radiator is reduced by 1 dB for every 3 dB that the directional gain of the antenna exceeds 6 dBi.</p>

9.2. Antenna Connected Construction

The BT antenna is a PCB Antenna which permanently attached, and the best case gain of the antenna is 0 dBi. It complies with the standard requirement.

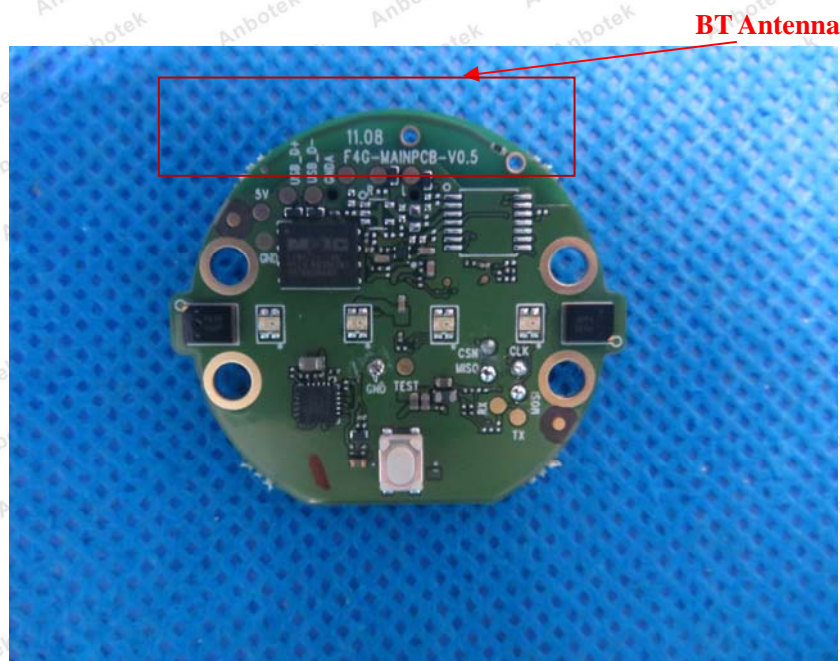

BT Antenna

APPENDIX I -- TEST SETUP PHOTOGRAPH

Photo of Radiation Emission Test

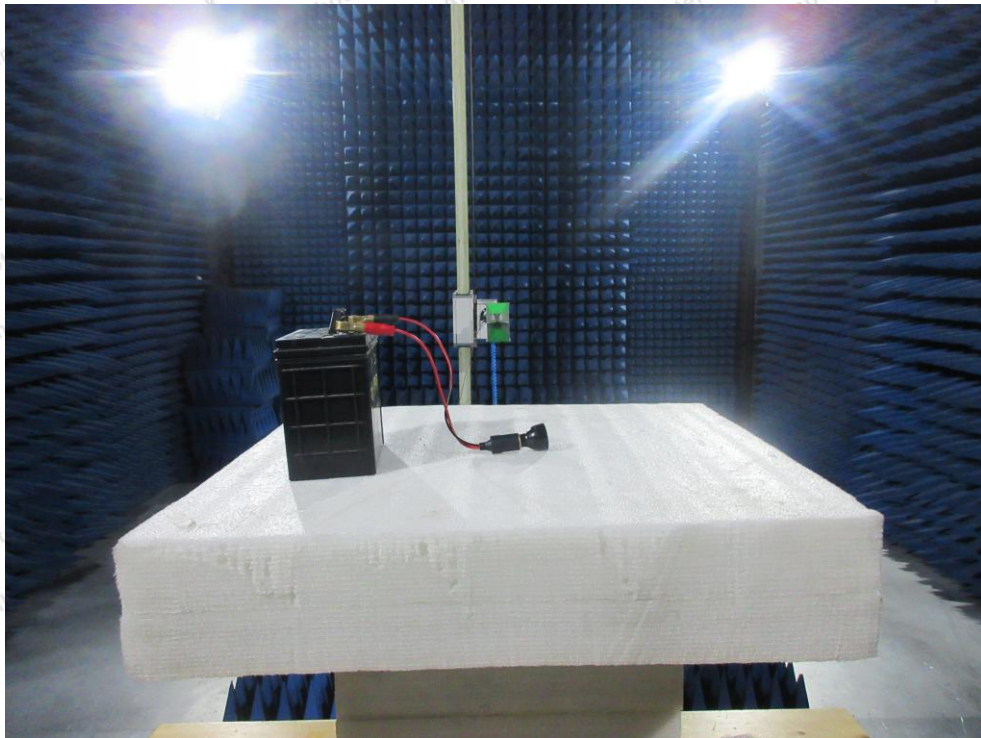
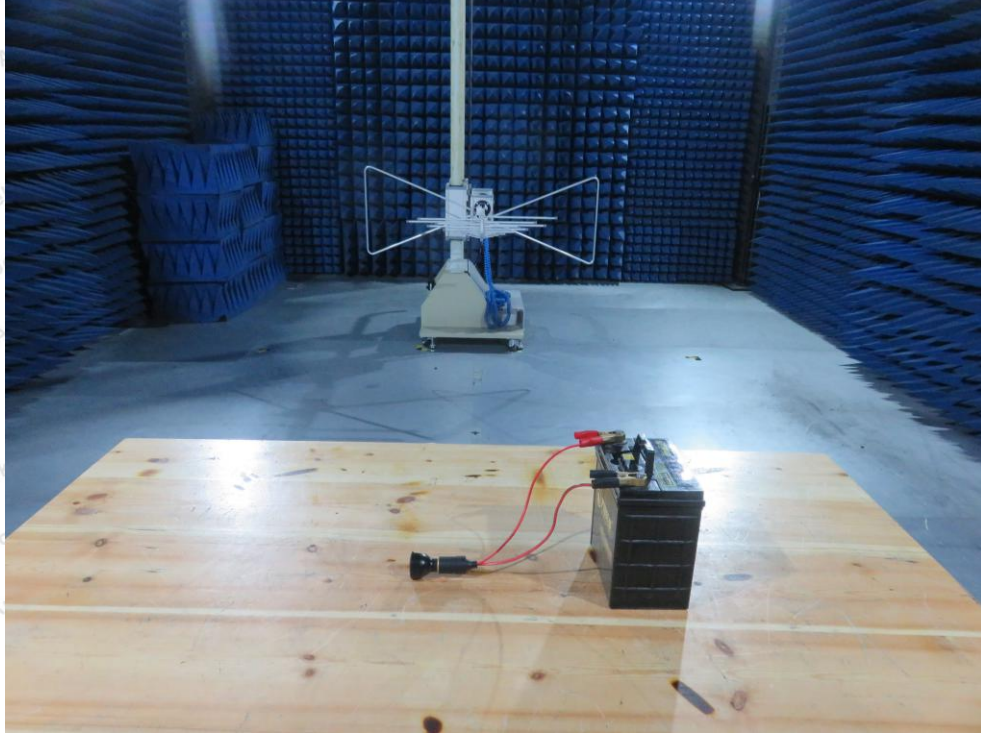

APPENDIX II -- EXTERNAL PHOTOGRAPH





APPENDIX III -- INTERNAL PHOTOGRAPH



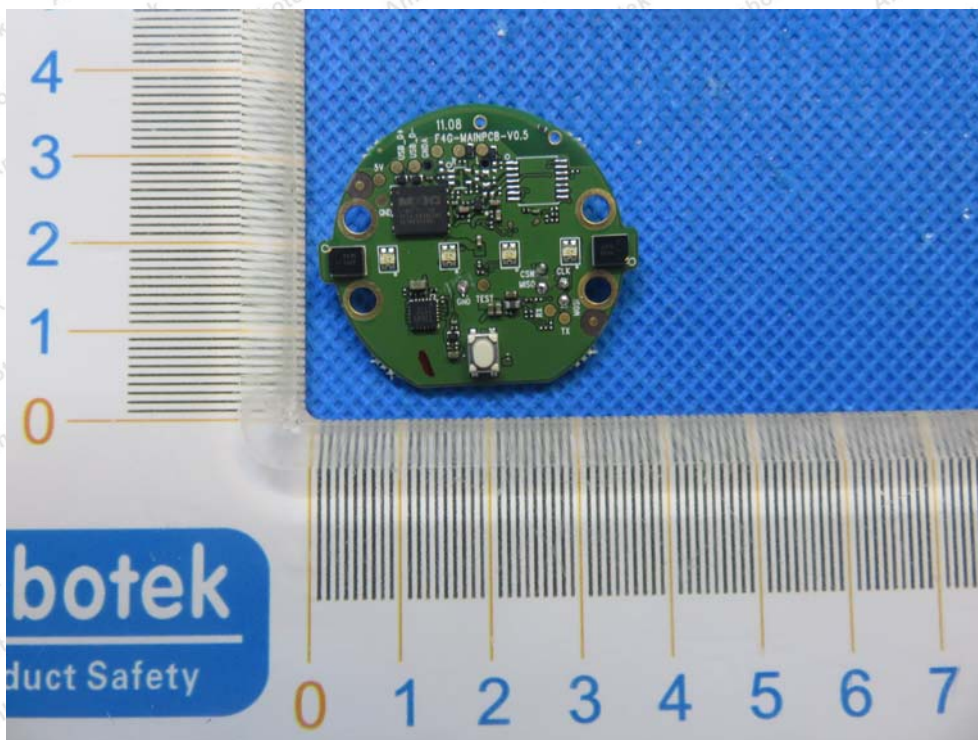

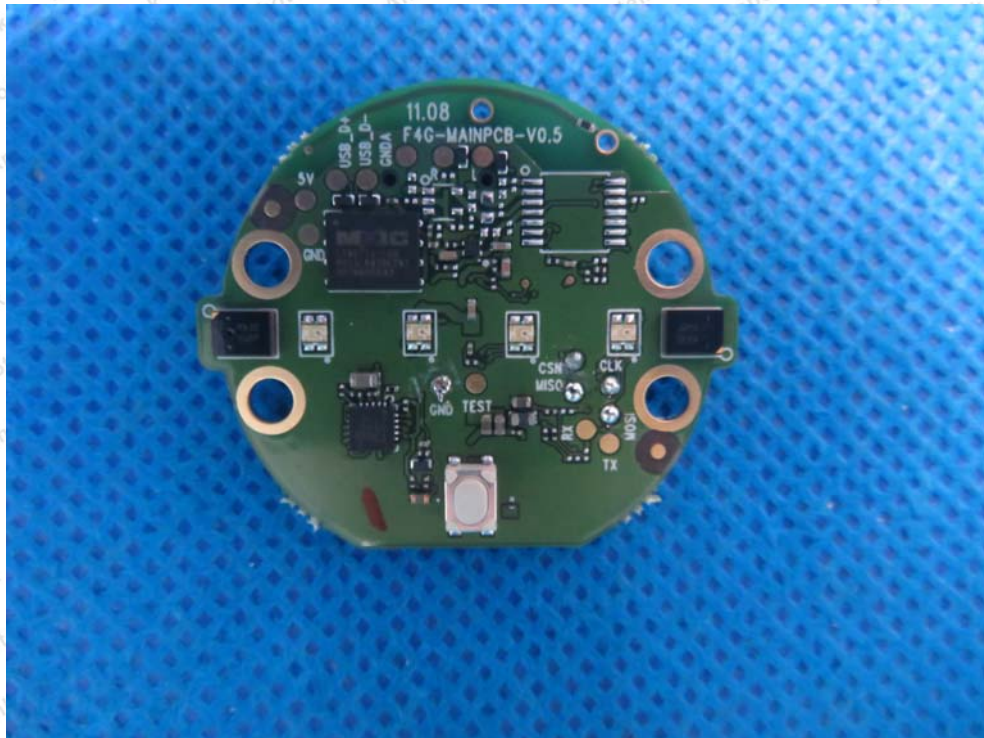
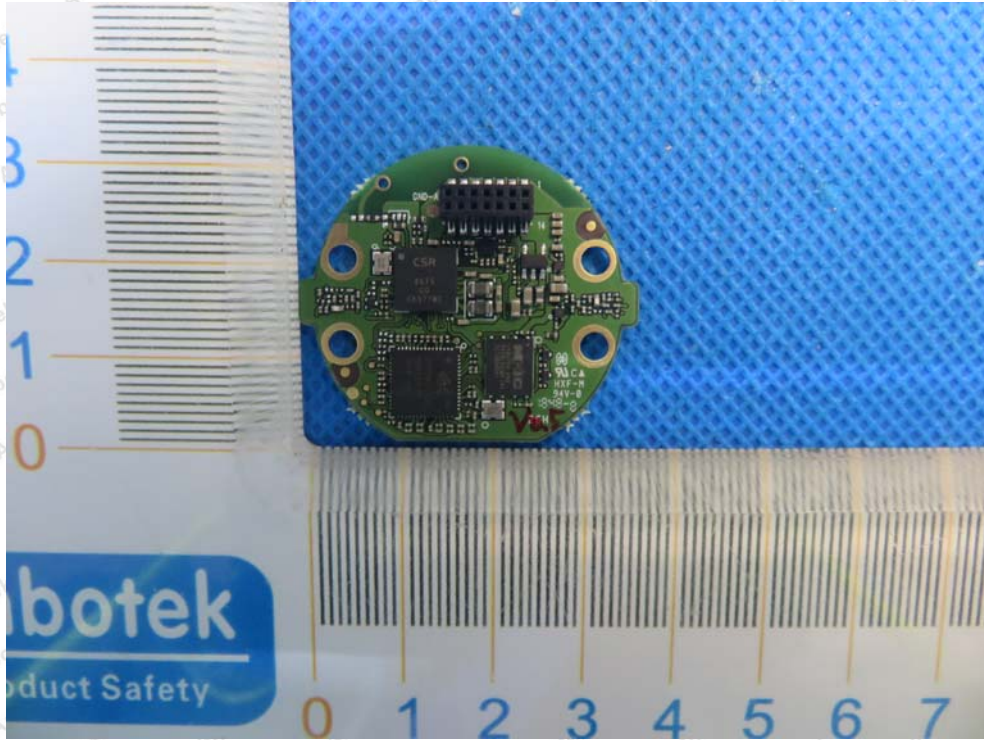

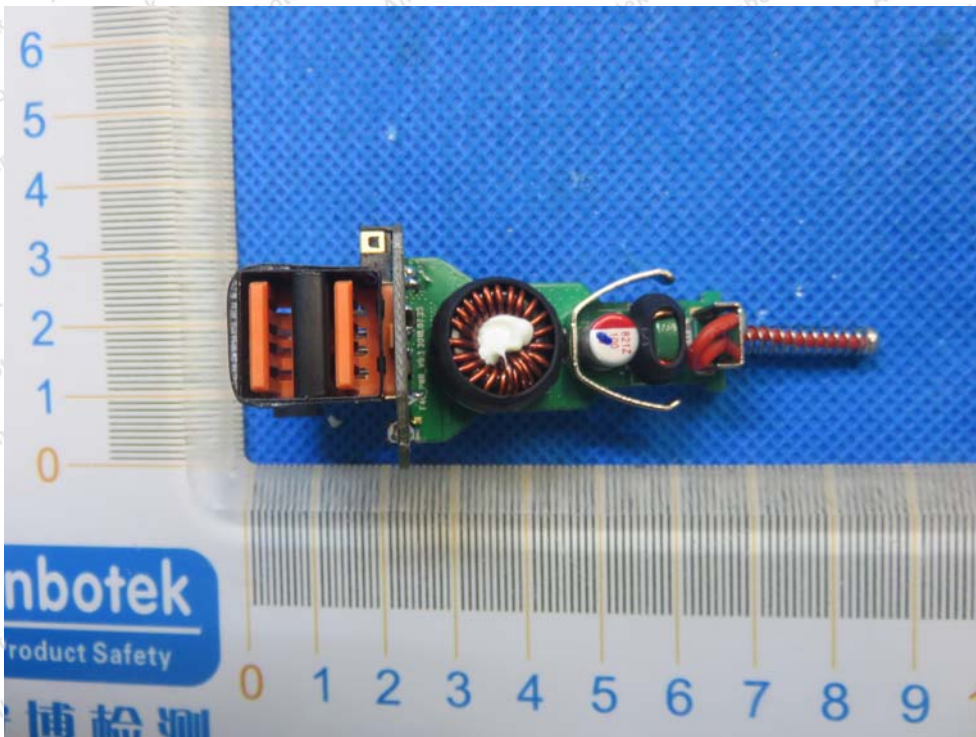
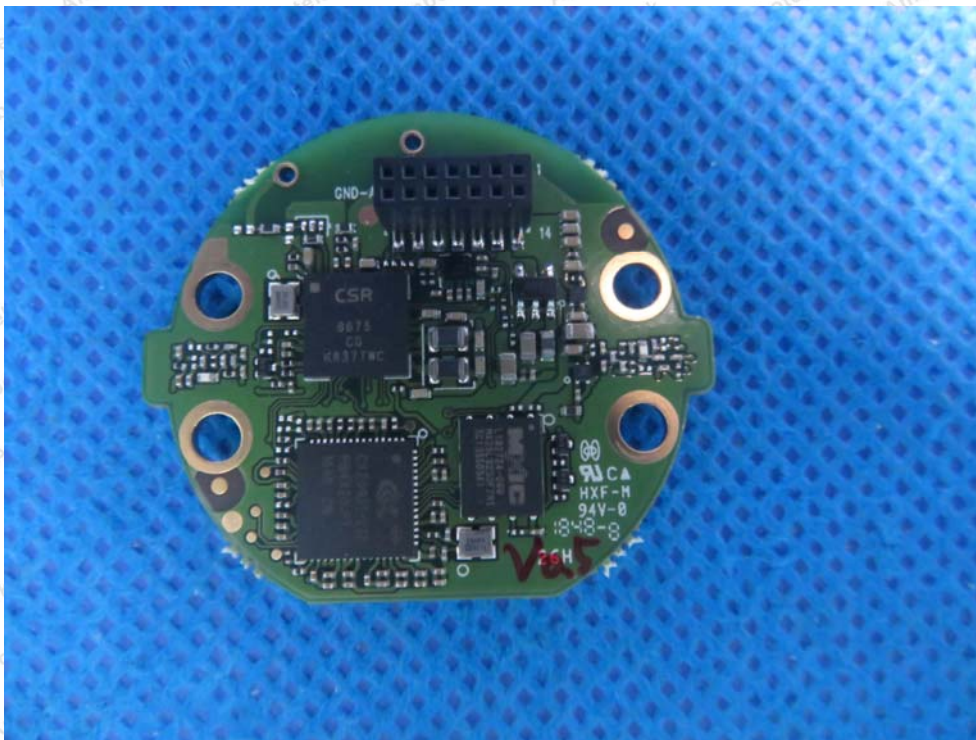

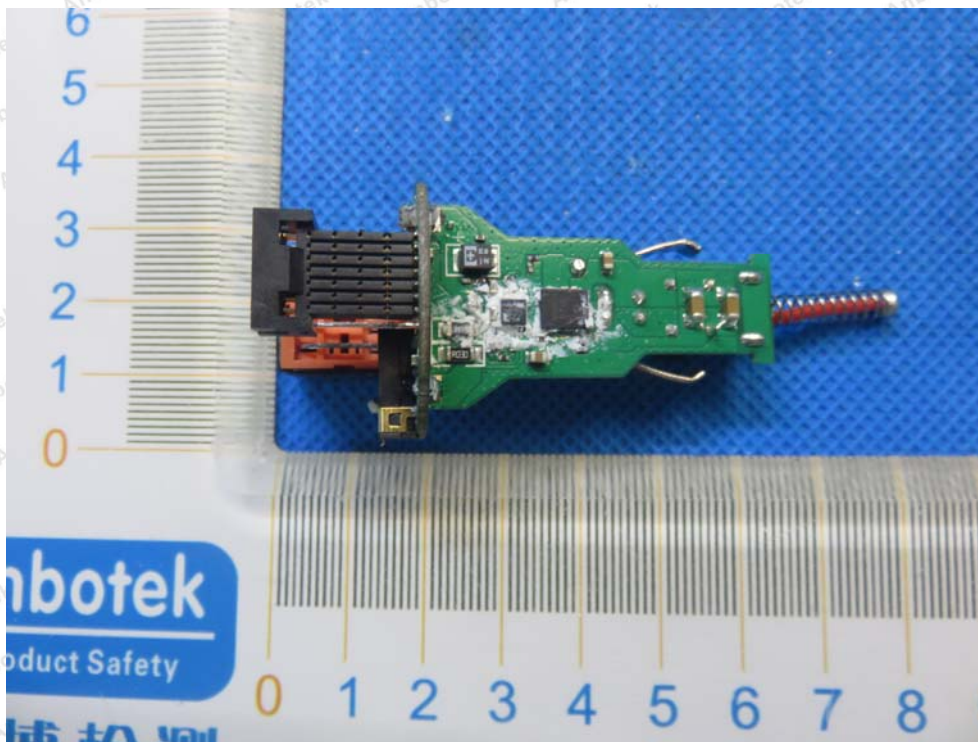

----- End of Report -----