

FCC - TEST REPORT

Report Number : **68.950.23.0861.01** Date of Issue: **2023-11-02**

Model : **DG-WF-H**

Product Type : WLAN Dongle

Applicant : Anker Innovations Limited

Address : Room 1318-19, Hollywood Plaza, 610 Nathan Road, Mongkok
Kowloon, HONG KONG

Manufacturer : Anker Innovations Limited

Address : Room 1318-19, Hollywood Plaza, 610 Nathan Road, Mongkok
Kowloon, HONG KONG

Test Result : **Positive** **Negative**

Total pages including Appendices : **41**

Any use for advertising purposes must be granted in writing. This technical report may only be quoted in full. This report is the result of a single examination of the object in question and is not generally applicable evaluation of the quality of other products in regular production. For further details, please see testing and certification regulation, chapter A-3.4.



1 Table of Contents

1	Table of Contents	2
2	Details about the Test Laboratory.....	3
3	Description of the Equipment Under Test.....	4
4	Summary of Test Standards.....	5
5	Summary of Test Results.....	6
6	General Remarks	7
7	Test Setups	8
8	Systems Test Configuration.....	9
9	Technical Requirement	10
9.1	Conducted Peak Output Power.....	10
9.2	Power Spectral Density	14
9.3	6 dB Bandwidth and 99% Occupied Bandwidth	17
9.4	Spurious RF Conducted Emissions	22
9.5	Band Edge.....	29
9.6	Spurious Radiated Emissions for Transmitter.....	32
10	Test Equipment List.....	39
11	System Measurement Uncertainty	41

2 Details about the Test Laboratory

Details about the Test Laboratory

Test Site 1

Company name: TÜV SÜD Certification and Testing (China) Co., Ltd. Shenzhen Branch
Building 12 & 13, Zhiheng Wisdomland Business Park, Guankou Erlu, Nantou,
Nanshan District, Shenzhen, Guangdong, China

Telephone: 86 755 8828 6998

Fax: 86 755 8828 5299

FCC Designation Number: CN5009

FCC Registration No.: 514049

3 Description of the Equipment Under Test

Product:	WLAN Dongle
Model no.:	DG-WF-H
FCC ID:	2AOKB-DGWFH
Options and accessories:	N/A
Rating:	8VDC, 0.3A
RF Transmission Frequency:	2402MHz-2480MHz
No. of Operated Channel:	40
Modulation:	GFSK
Antenna Type:	Internal antenna
Antenna	Gain: 2.9dBi

Description of the EUT: The Equipment Under Test (EUT) is a WLAN Dongle which support Bluetooth Low Energy and 2.4GHz WIFI functions. This report only for Bluetooth Low Energy part.

NOTE 1: The above EUT's information is declared by manufacturer. Please refer to the specifications or user's manual for more detailed description.

4 Summary of Test Standards

Test Standards	
FCC Part 15 Subpart C 10-1-2021 Edition	PART 15 - RADIO FREQUENCY DEVICES Subpart C - Intentional Radiators

All the test methods were according to KDB 558074 D01 15.247 Meas Guidance v05r02 Measurement Guidance and ANSI C63.10-2020.

5 Summary of Test Results

Technical Requirements			
FCC Part 15 Subpart C			
Test Condition		Test Site	Test Result
§15.207	Conducted emission AC power port	N/A	N/A
§15.247(b)(3)	Conducted peak output power	Site 1	Pass
§15.247(e)	Power spectral density	Site 1	Pass
§15.247(a)(2)	6dB bandwidth and 99% Occupied Bandwidth	Site 1	Pass
§15.247(d)	Spurious RF conducted emissions	Site 1	Pass
§15.247(d)	Band edge	Site 1	Pass
§15.247(d) & §15.209	Spurious radiated emissions for transmitter	Site 1	Pass
§15.203	Antenna requirement	See note 2	Pass

Note 1: N/A=Not Applicable.

Note 2: The EUT uses an internal antenna, which gain is 2.9dBi. In accordance to §15.203, it is considered sufficiently to comply with the provisions of this section.

6 General Remarks

Remarks

This submittal(s) (test report) is intended for FCC ID: 2AOKB-DGWFH, complies with complies with Section 15.209, 15.247 of the FCC Part 15, Subpart C rules.

SUMMARY:

All tests according to the regulations cited on page 5 were

■ - Performed

□ - **Not** Performed

The Equipment under Test

■ - **Fulfills** the general approval requirements.

□ - **Does not** fulfill the general approval requirements.

Sample Received Date: 2023-09-27

Testing Start Date: 2023-09-27

Testing End Date: 2023-10-30

- TÜV SÜD Certification and Testing (China) Co., Ltd. Shenzhen Branch -

Reviewed by:

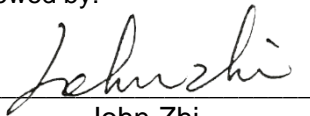

John Zhi
Project Manager

Prepared by:



Joe Gu
Project Engineer

Tested by:

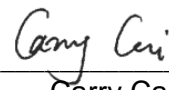

Carry Cai
Test Engineer



7 Test Setups

7.1 Radiated test setups

9KHz - 30MHz

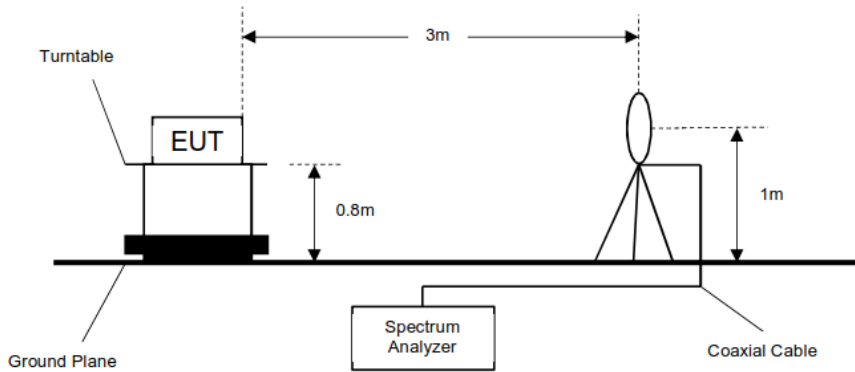

30MHz - 1GHz

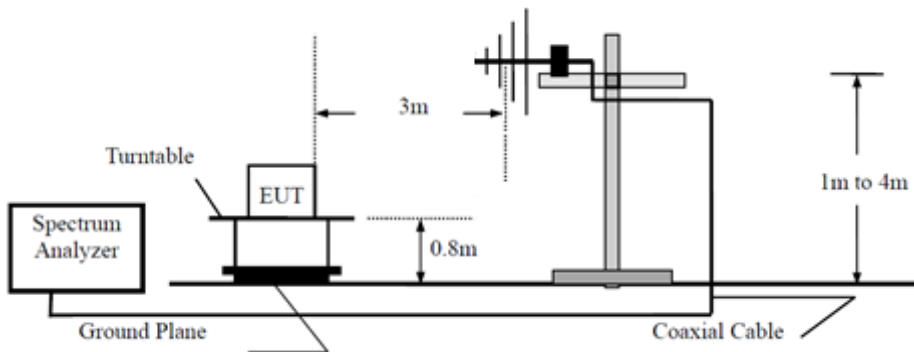

Above 1GHz

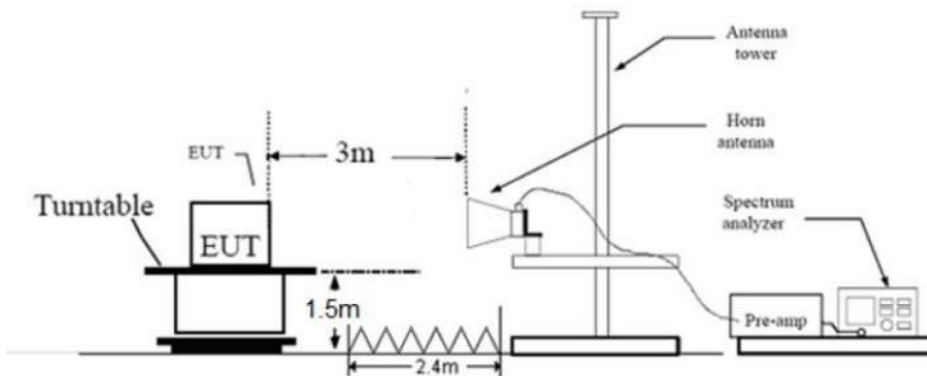

7.2 Conducted RF test setups

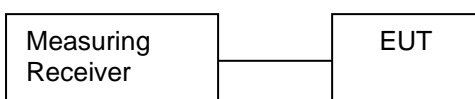

8 Systems Test Configuration

Auxiliary Equipment Used during Test:

Equipment	Brand	Model/Type No.	Series No.
LAPTOP	Lenove	ThinkPad T460s	---

The system was configured to non-hopping mode, testing channel 0, 19, 39.

9 Technical Requirement

9.1 Conducted Peak Output Power

Test Method

1. The RF output of EUT was connected to the test receiver by RF cable. The path loss was compensated to the results for each measurement.
2. Set to the maximum power setting and enable the EUT transmit continuously.
3. Use the following test receiver settings:
Span = approximately 5 times the 6dB bandwidth, centered on a hopping channel
RBW > the 6dB bandwidth of the emission being measured, VBW \geq 3RBW,
Sweep = auto, Detector function = peak, Trace = max hold
4. Allow the trace to stabilize. Use the marker-to-peak function to set the marker to the peak of the emission. The indicated level is the peak output power and record the results in the test report.
5. Repeat above procedures until all frequencies measured were complete.

Limits

According to §15.247 (b) (3), conducted peak output power limit as below:

Frequency Range MHz	Limit W	Limit dBm
2400-2483.5	≤ 1	≤ 30

Conducted Peak Output Power

Frequency MHz	Mode	Conducted Peak Output Power dBm	Result
Bottom channel 2402MHz	LE 1Mbps	3.24	Pass
Middle channel 2440MHz	LE 1Mbps	3.45	Pass
Top channel 2480MHz	LE 1Mbps	4.14	Pass

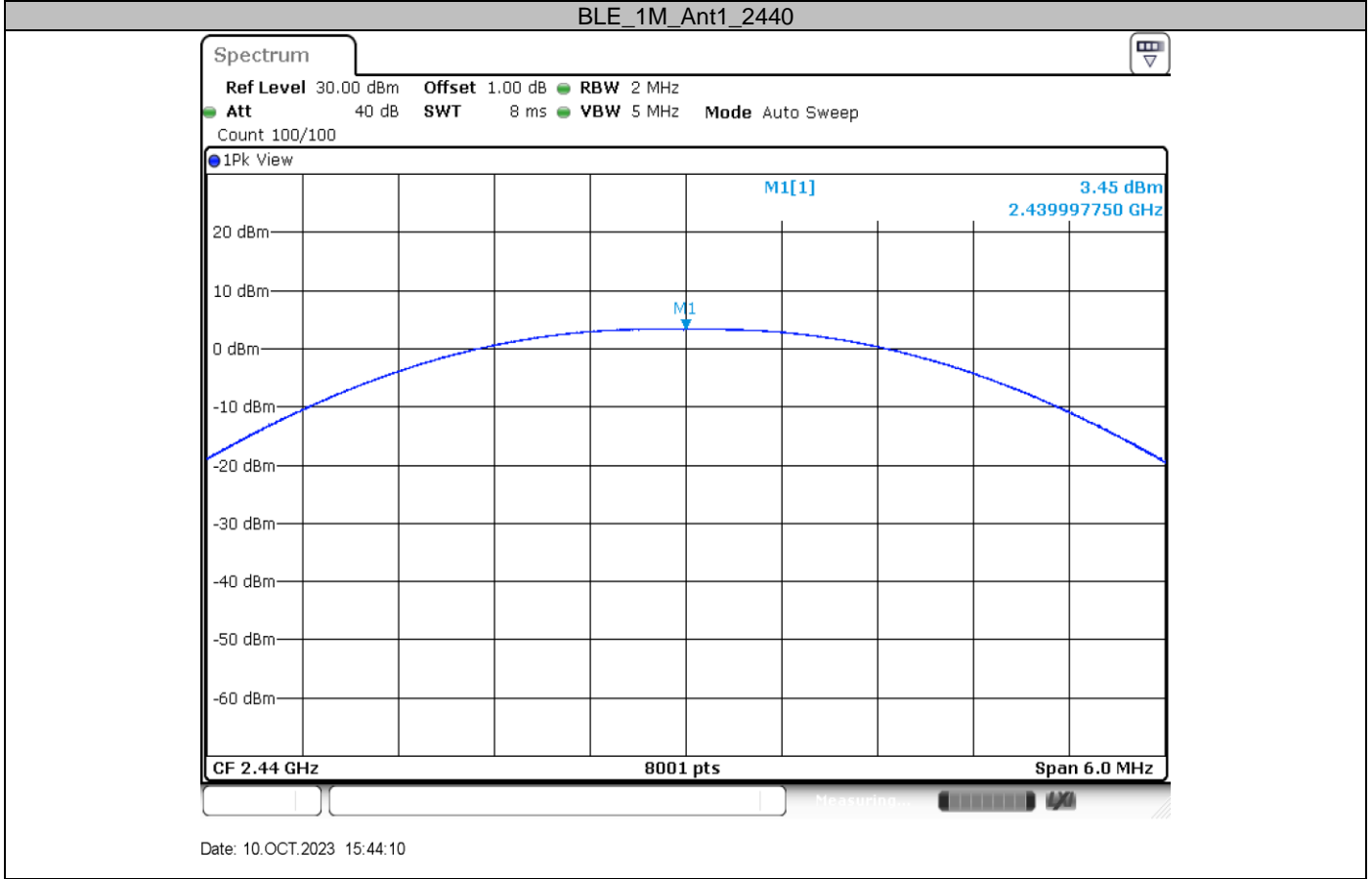
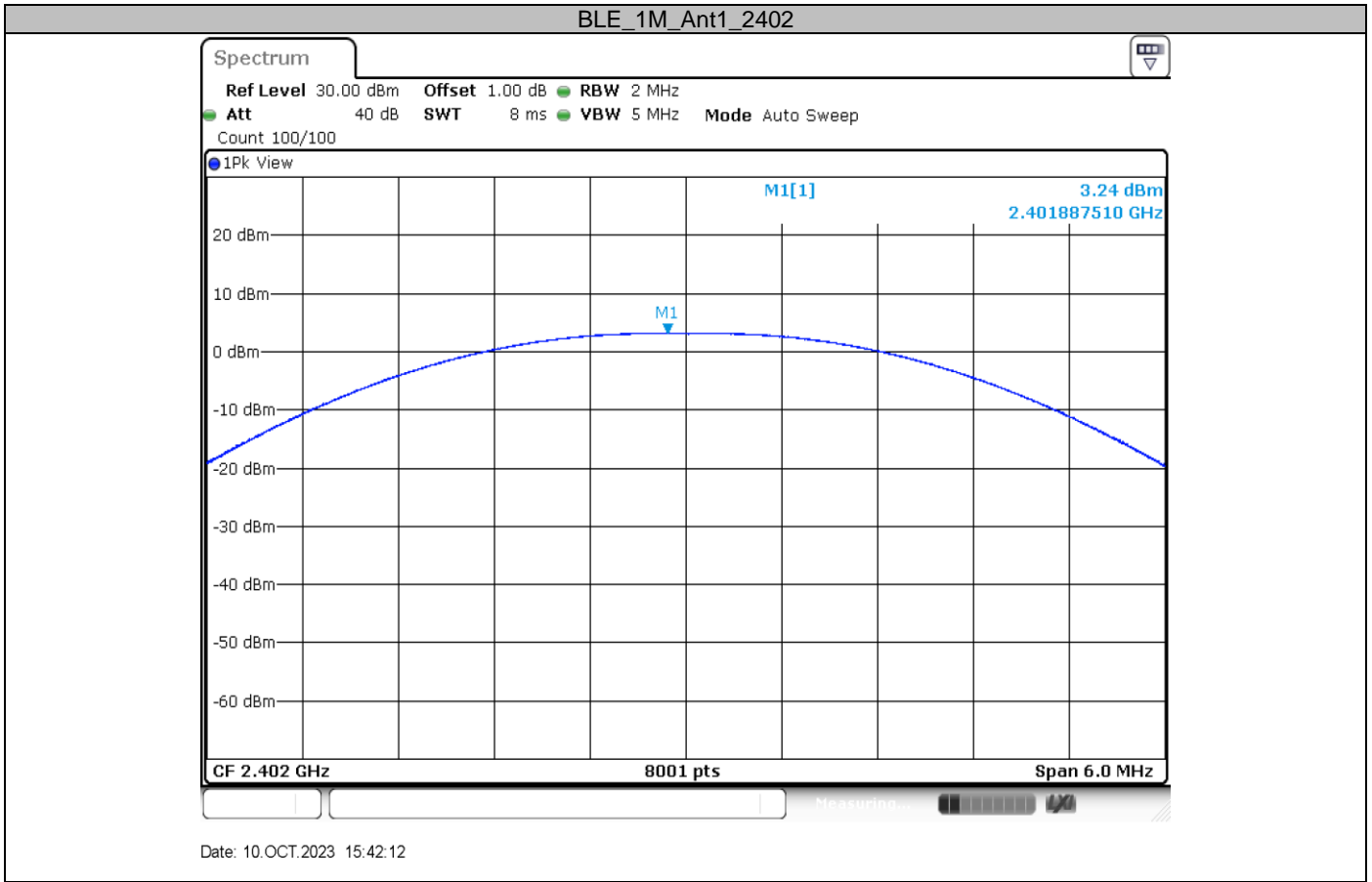

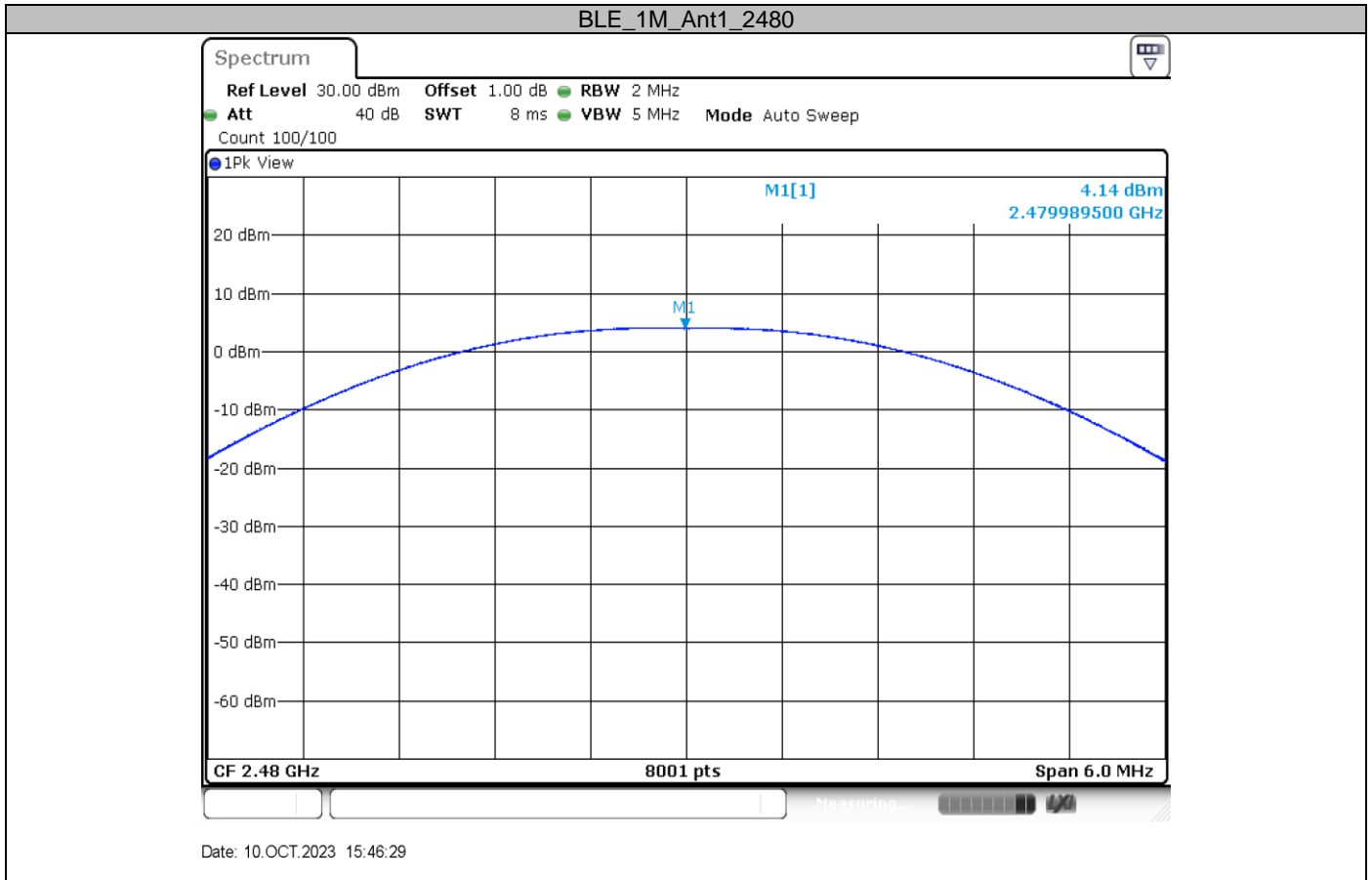

9.2 Power Spectral Density

Test Method

1. The RF output of EUT was connected to the spectrum analyzer. The path loss was compensated to the results for each measurement.
2. Set to the maximum power setting, the instrument center frequency is set to the nominal EUT channel center frequency enable the EUT transmit continuously.
3. Use the following spectrum analyzer settings:
4. Set analyzer center frequency to DTS channel center frequency. RBW=3kHz, VBW≥3RBW, Span=1.5 times DTS bandwidth, Detector=Peak, Sweep=auto, Trace= max hold.
5. Allow trace to fully stabilize, use the peak marker function to determine the maximum amplitude level within the RBW.
6. Repeat above procedures until other frequencies measured were completed.

Limit

Limit [dBm/3KHz]

≤8

Test result

Frequency MHz	Mode	Power spectral density dBm/3KHz	Result
Bottom channel 2402MHz	LE 1Mbps	-13.15	Pass
Middle channel 2440MHz	LE 1Mbps	-13.15	Pass
Top channel 2480MHz	LE 1Mbps	-12.24	Pass

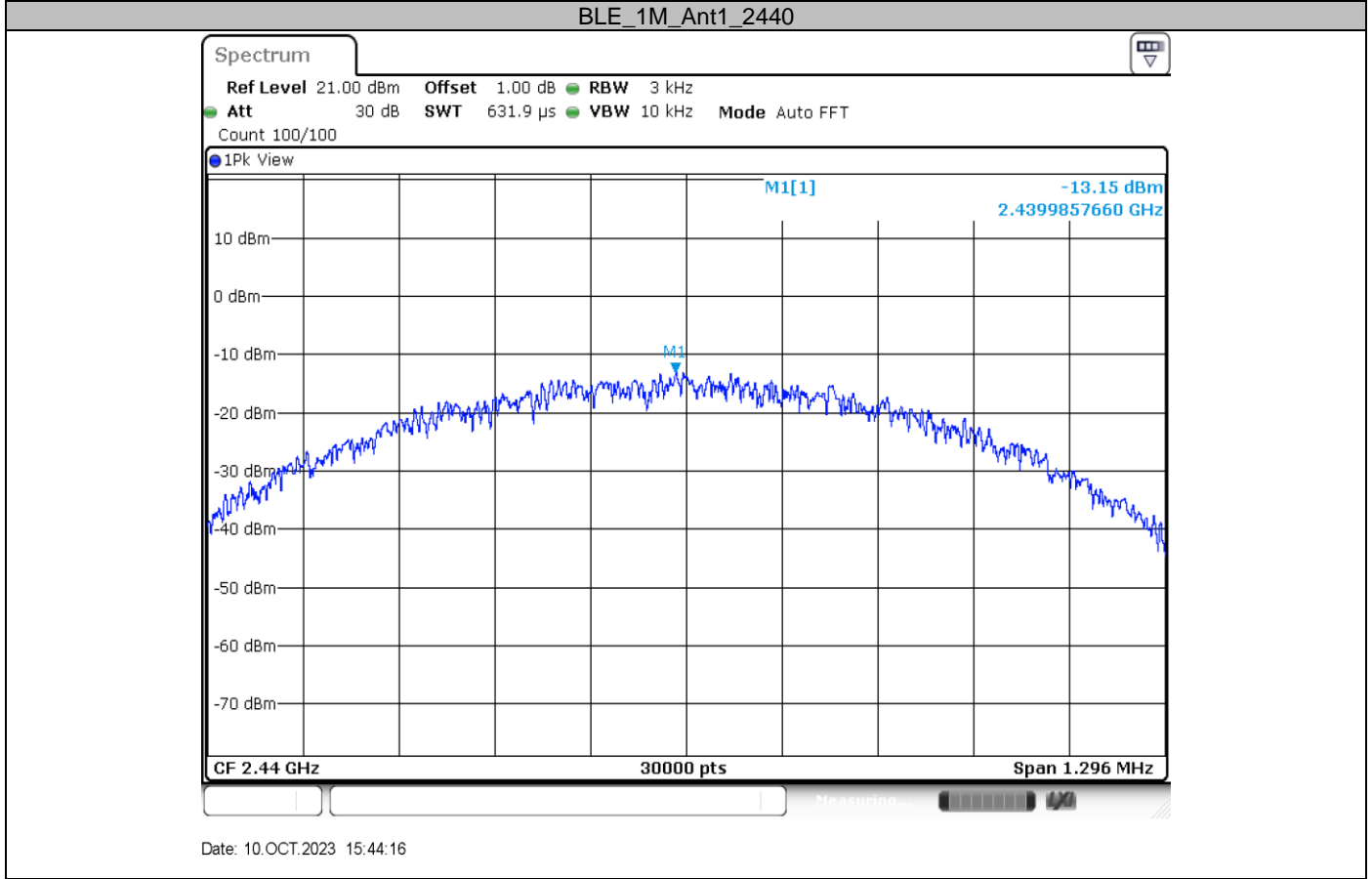
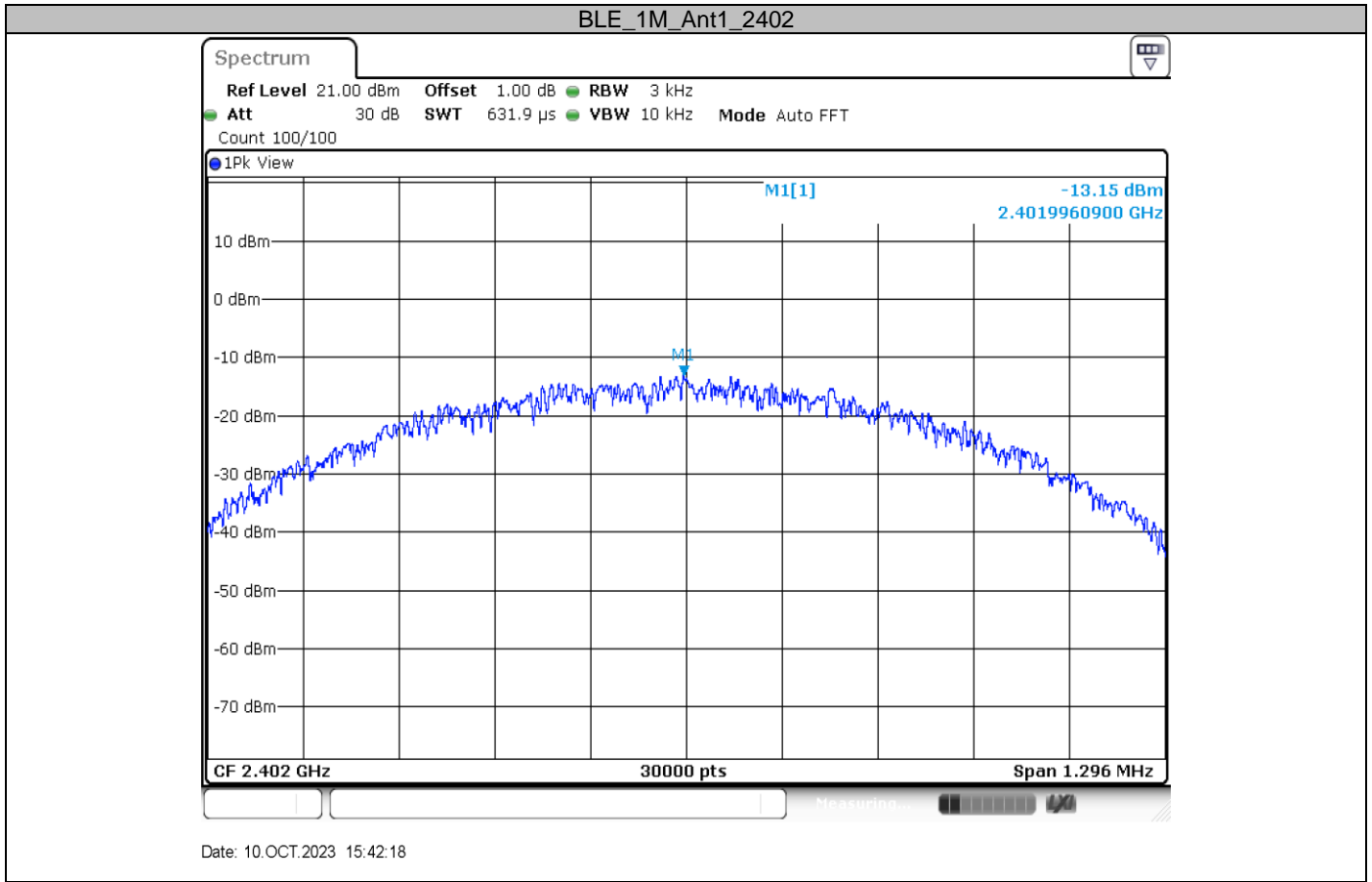

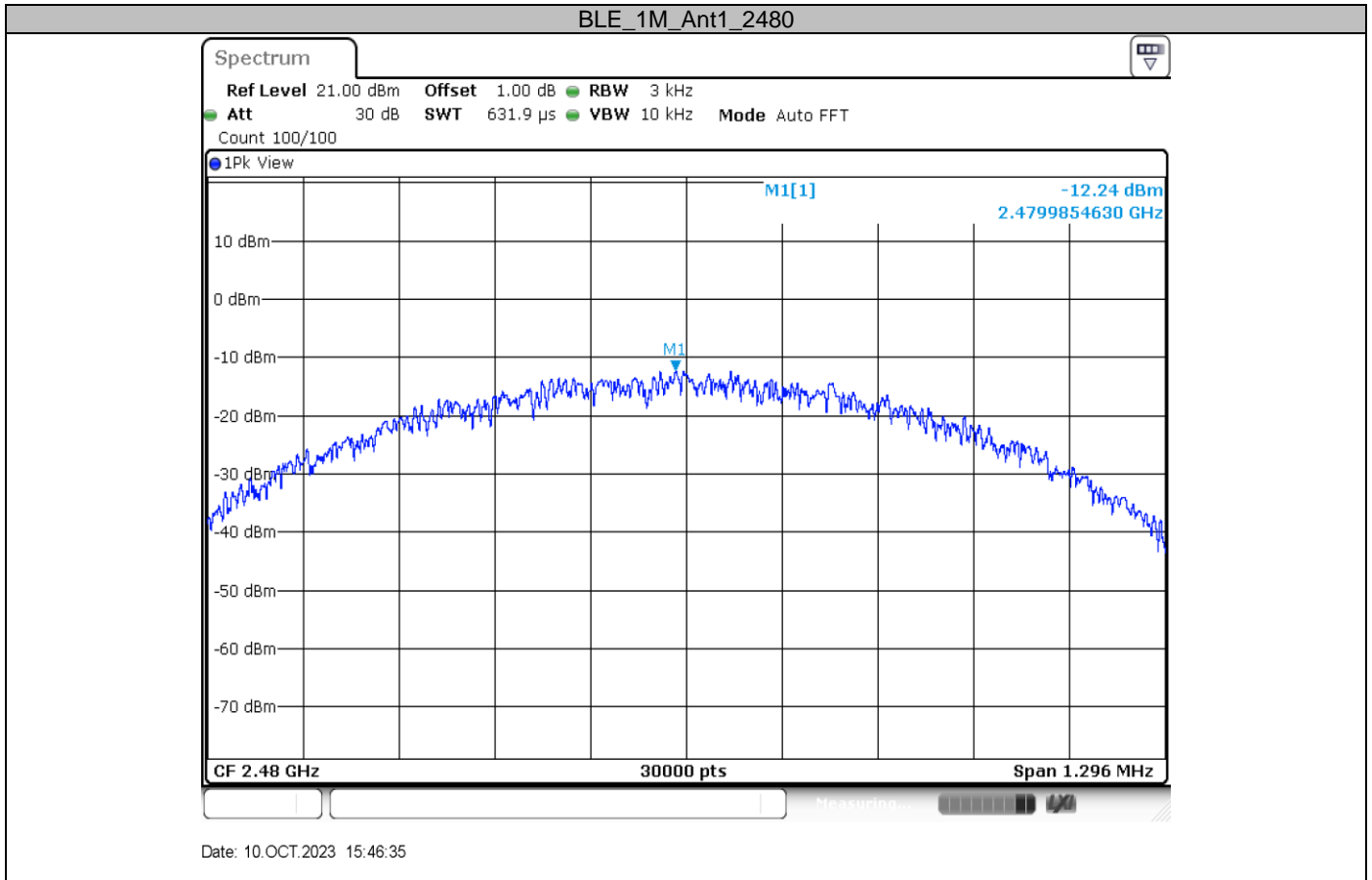

9.3 6 dB Bandwidth and 99% Occupied Bandwidth

Test Method for 6 dB Bandwidth

1. Set center frequency to the nominal EUT channel center frequency
2. Set RBW = 100KHz
3. Set the video bandwidth (VBW) $\geq 3 \times$ RBW
4. Detector = Peak.
5. Trace mode = max hold.
6. Sweep = Sweep = No faster than coupled (auto) time.
7. Allow the trace to stabilize.
8. Measure the maximum width of the emission that is constrained by the frequencies associated with the two outermost amplitude points (upper and lower frequencies) that are attenuated by 6 dB relative to the maximum level measured in the fundamental emission.
9. Record the results in the test report.

Limit

Limit [kHz]

≥500

Test Method for 99 % Bandwidth

1. Set center frequency to the nominal EUT channel center frequency
2. Set span = 1.5 times to 5.0 times the OBW.
3. Set RBW = 1 % to 5 % of the OBW
4. Set VBW ≥ 3 RBW
5. Trace mode = max hold.
6. Sweep = auto couple.
7. Allow the trace to stabilize.
8. Use the 99 % power bandwidth function of the instrument.
9. Record the results in the test report.

Limit

Limit [kHz]

Test result

Frequency MHz	Mode	6dB bandwidth MHz	99% bandwidth MHz	Result
Bottom channel 2402MHz	LE 1M	0.648	1.007	Pass
Middle channel 2440MHz	LE 1M	0.648	1.007	Pass
Top channel 2480MHz	LE 1M	0.648	1.011	Pass

6 dB Bandwidth

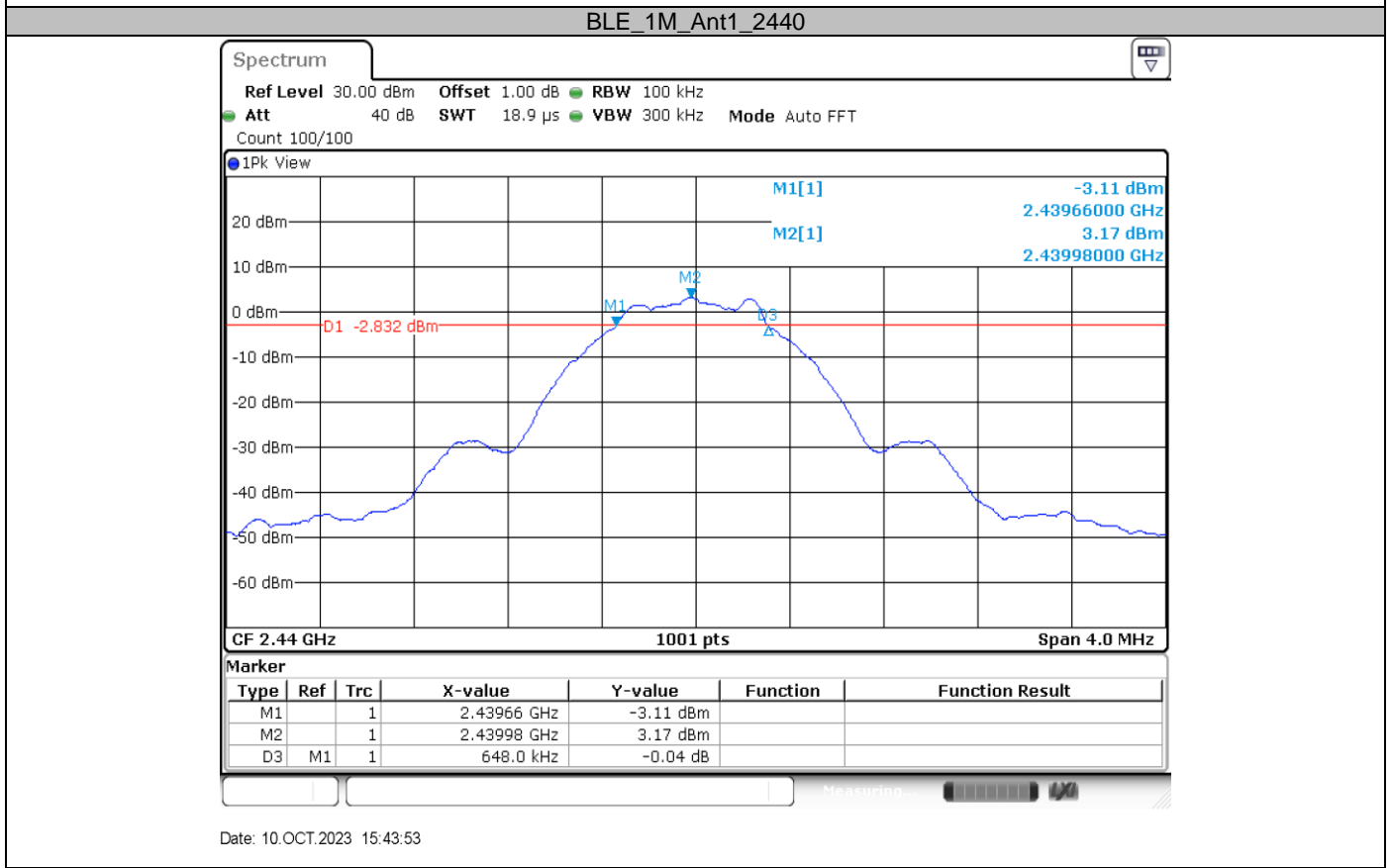
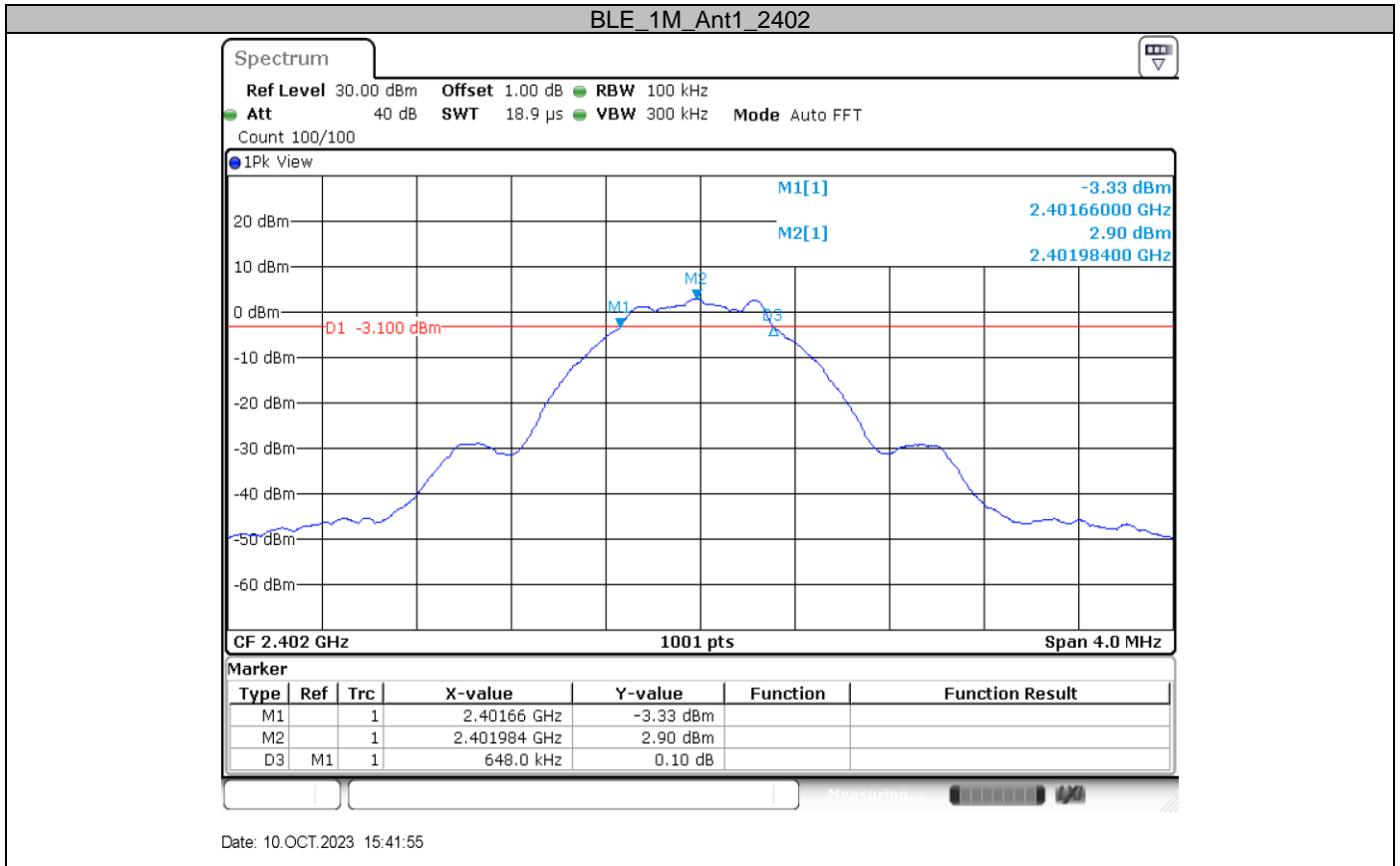

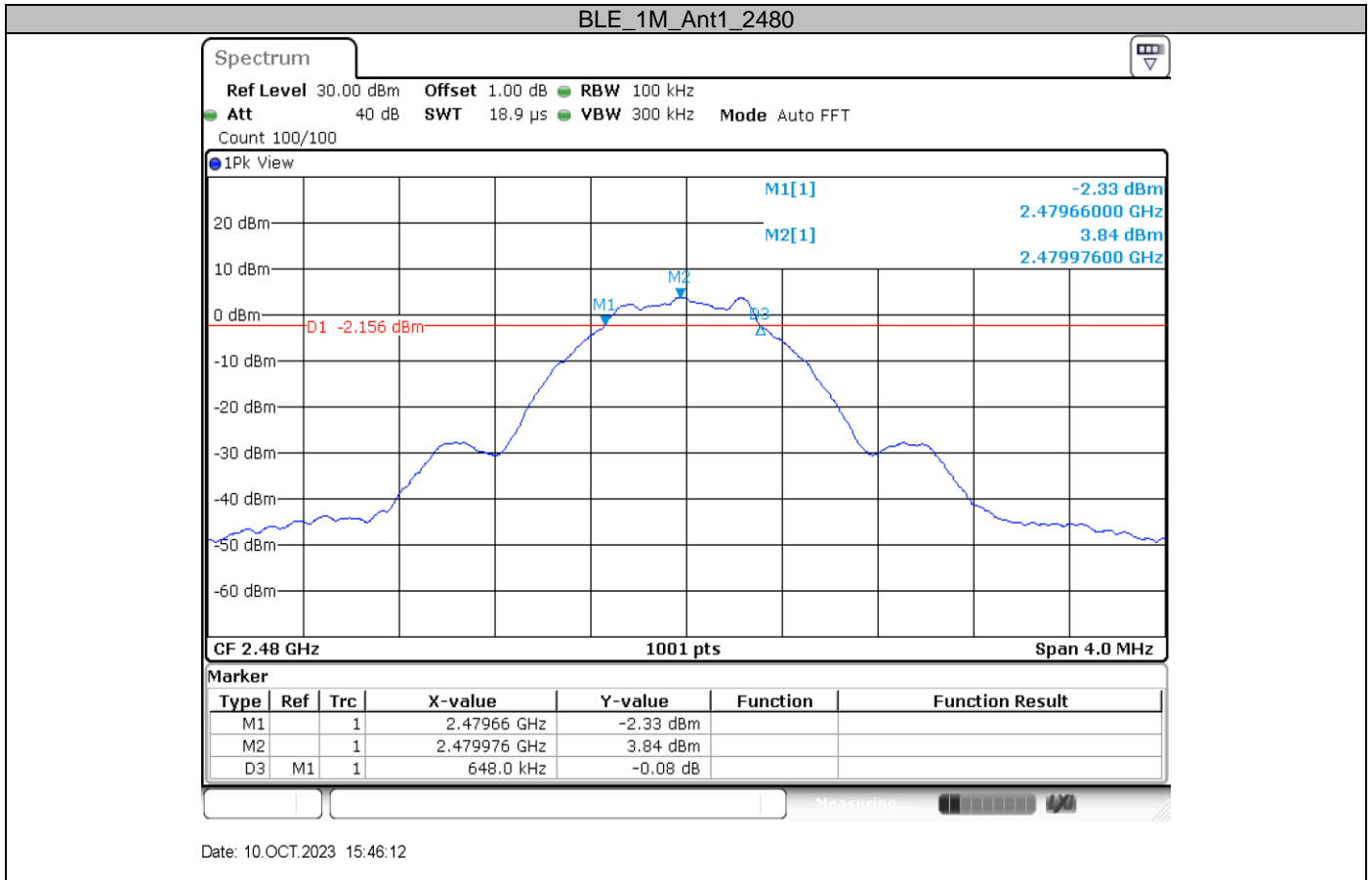

99% Bandwidth

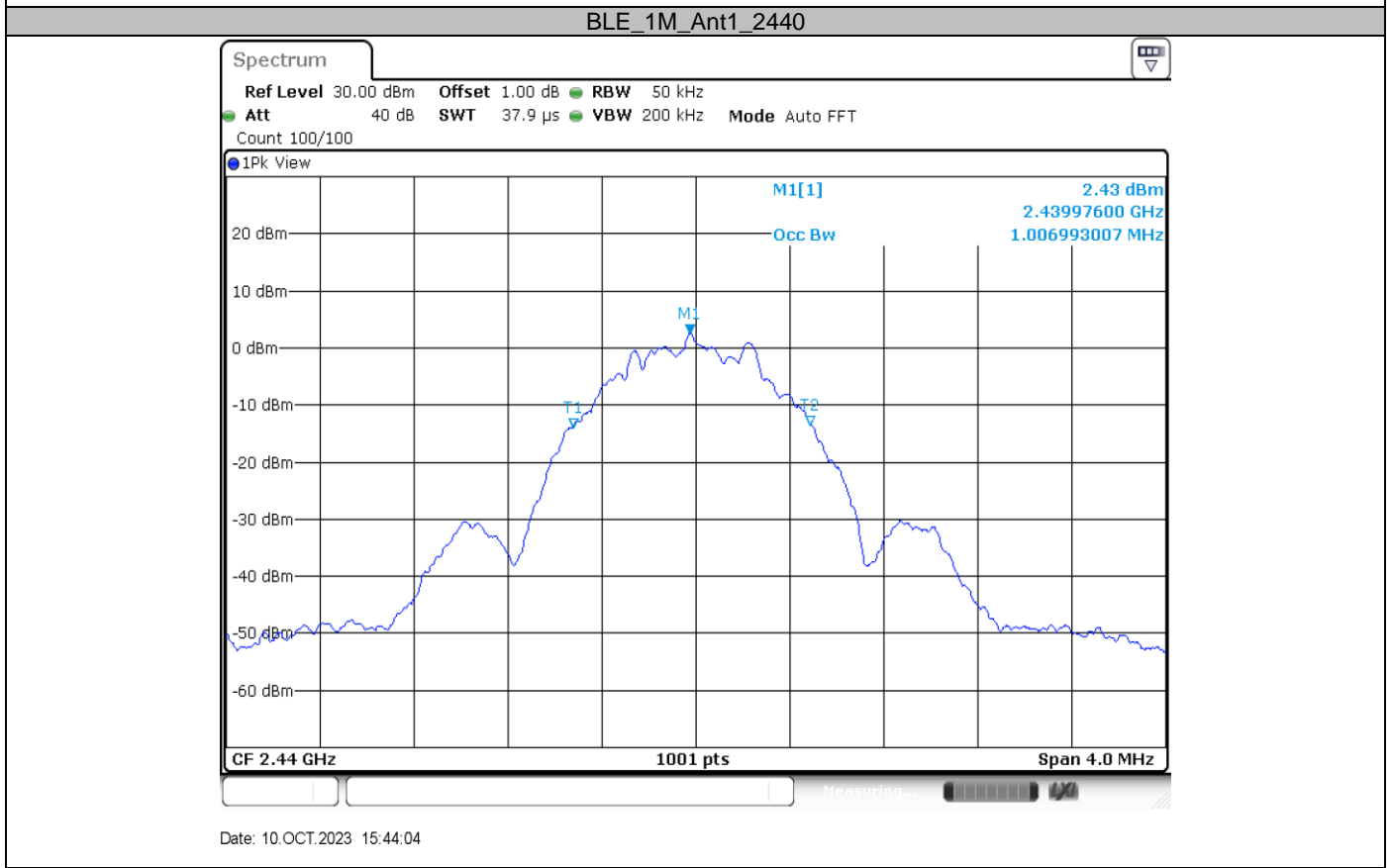
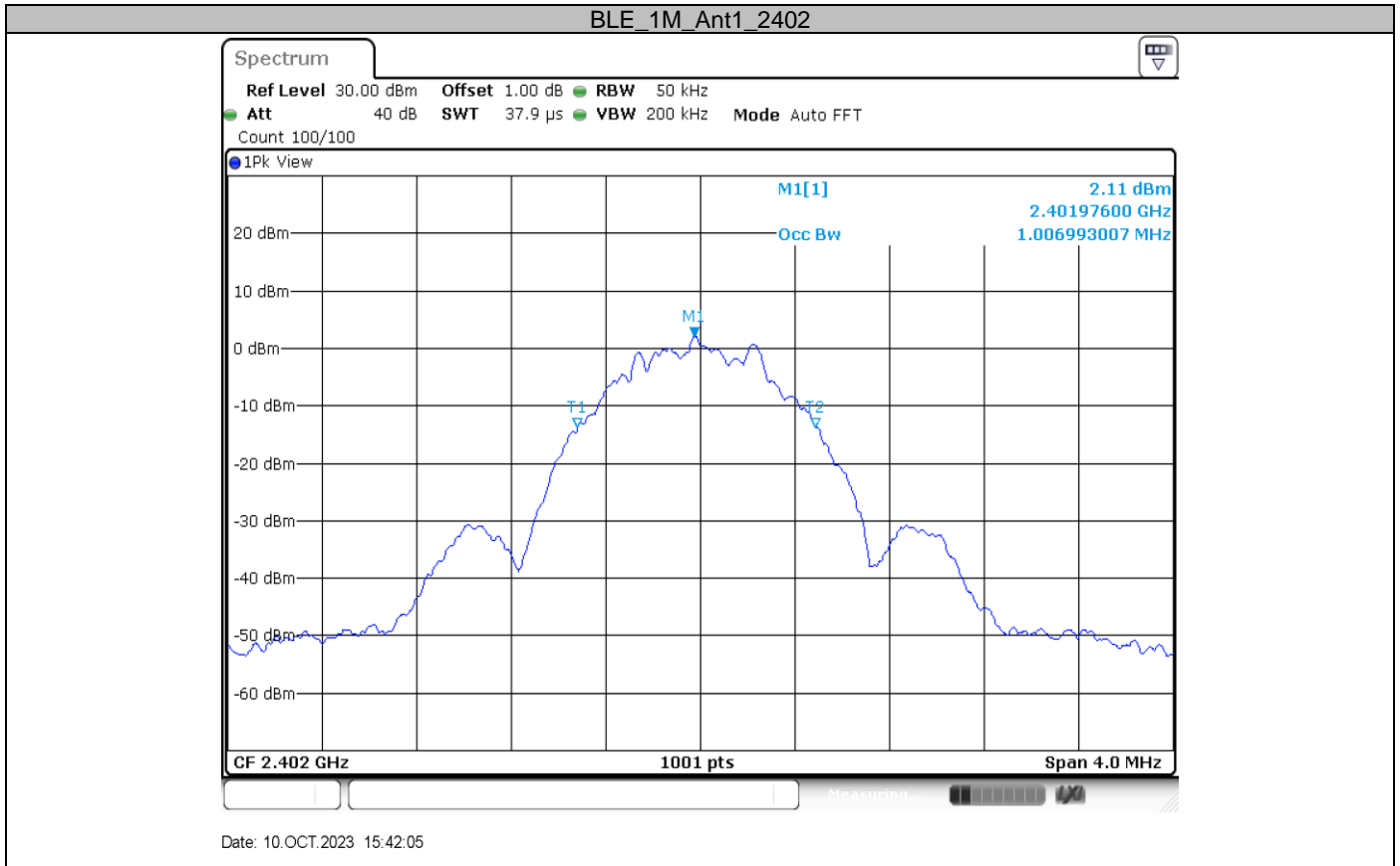

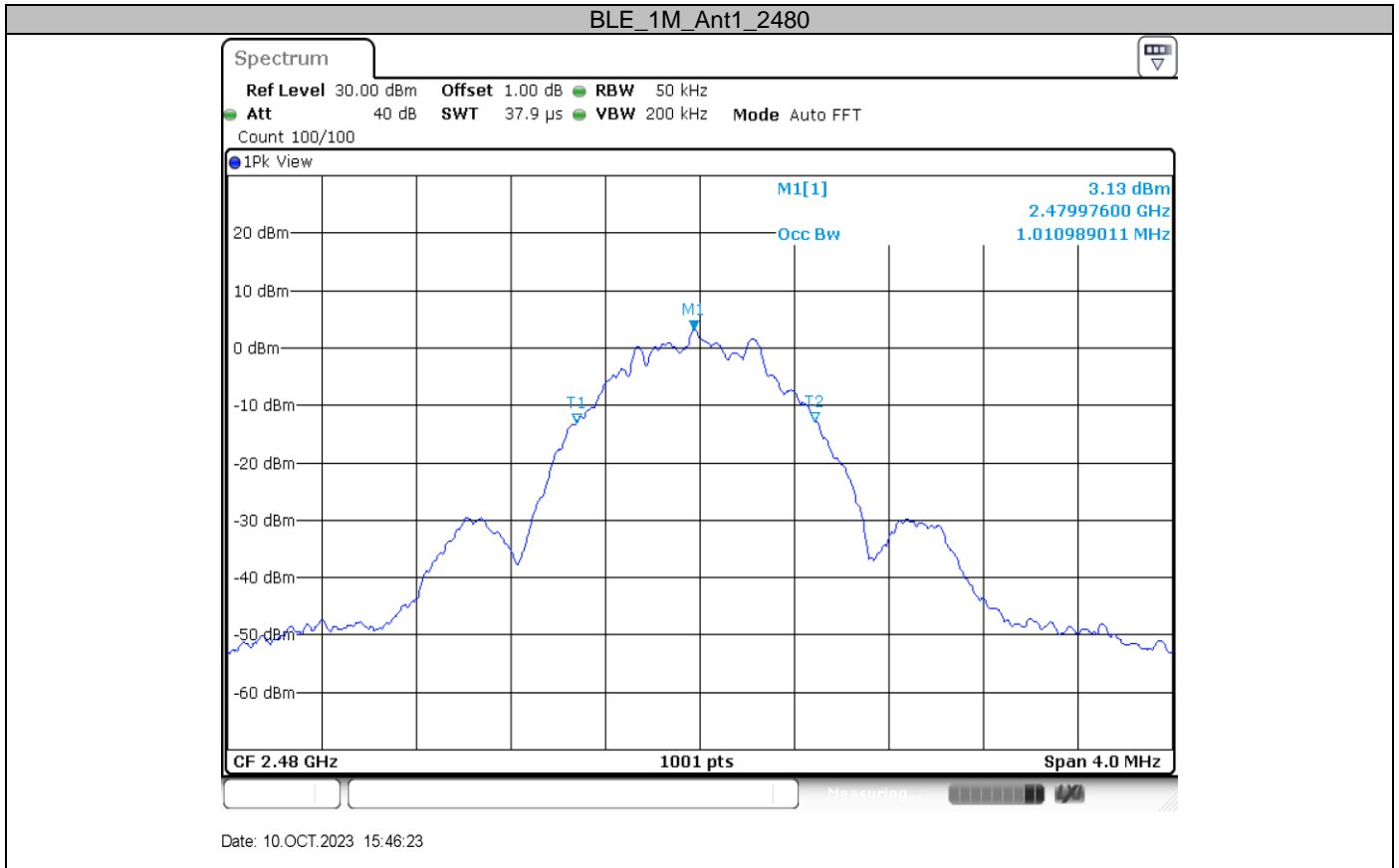

9.4 Spurious RF Conducted Emissions

Test Method

1. The RF output of EUT was connected to the spectrum analyzer by RF cable. The path loss was compensated to the results for each measurement.
2. Set to the maximum power setting, the instrument center frequency is set to the nominal EUT channel center frequency enable the EUT transmit continuously.
3. Use the following spectrum analyzer settings:
Span = wide enough to capture the peak level of the in-band emission and all spurious emissions (e.g., harmonics) from the lowest frequency generated in the EUT up through the 10th harmonic. Typically, several plots are required to cover this entire span.
RBW = 100 kHz, VBW \geq 3RBW, Sweep = auto, Detector function = peak, Trace = max hold
4. Allow the trace to stabilize. Set the marker on the peak of any spurious emission recorded.
5. The level displayed must comply with the limit specified in this Section. Submit these plots.
6. Repeat above procedures until all frequencies measured were complete.

Limit

Frequency Range MHz	Limit (dBc)
30-25000	-20

Spurious RF conducted emissions

TestMode	Channel (MHz)	Frequency Range (MHz)	Result (dBm)	Limit (dBm)	Limit	Verdict
BLE_BT4.0	2402	Reference	3.02	3.02	---	PASS
		30~1000	30~1000	-49.13	<=-16.98	PASS
		1000~26500	1000~26500	-40.75	<=-16.98	PASS
	2440	Reference	3.05	3.05	---	PASS
		30~1000	30~1000	-47.64	<=-16.95	PASS
		1000~26500	1000~26500	-41.23	<=-16.95	PASS
	2480	Reference	3.85	3.85	---	PASS
		30~1000	30~1000	-46.79	<=-16.15	PASS
		1000~26500	1000~26500	-43.17	<=-16.15	PASS

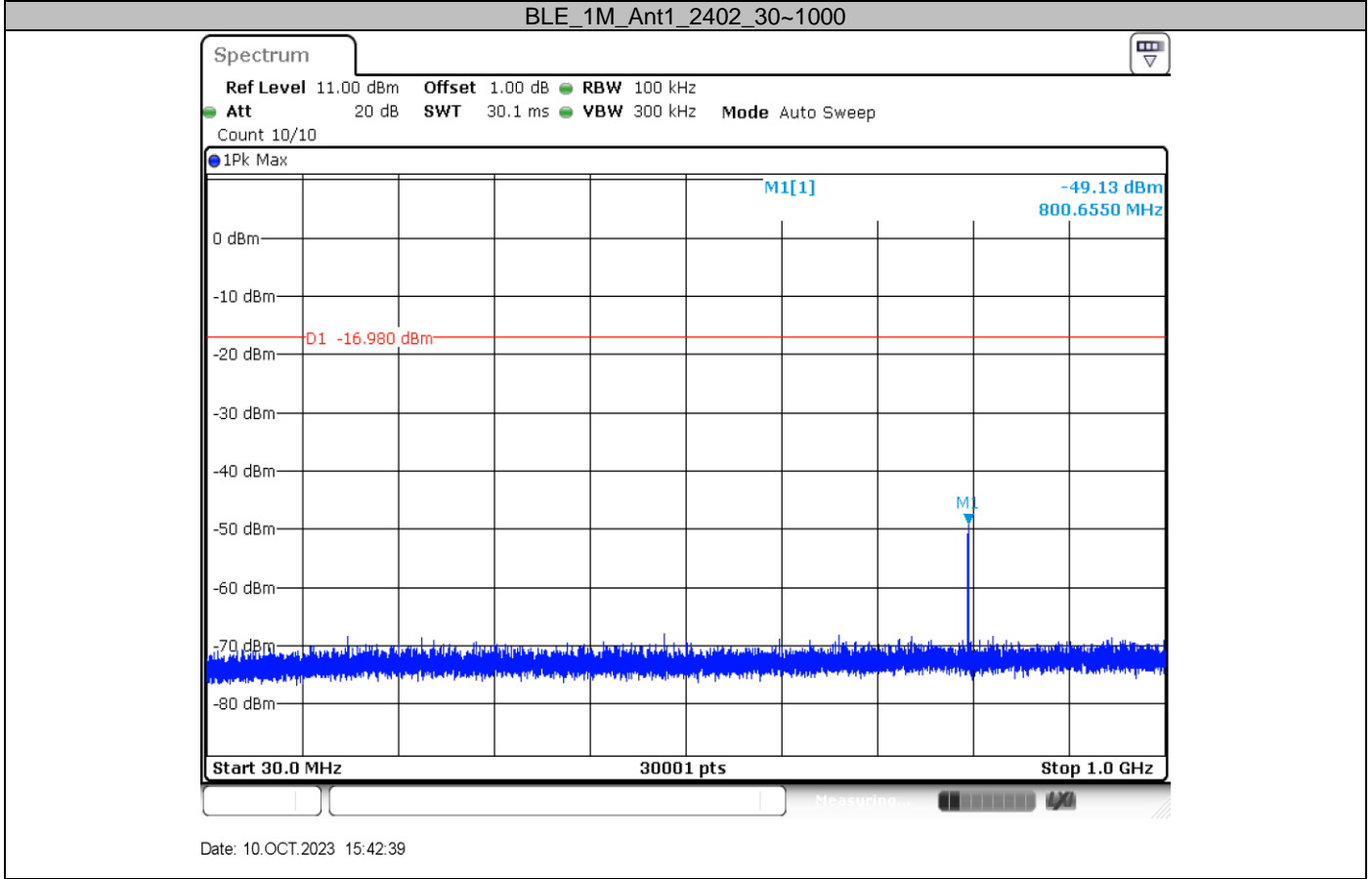
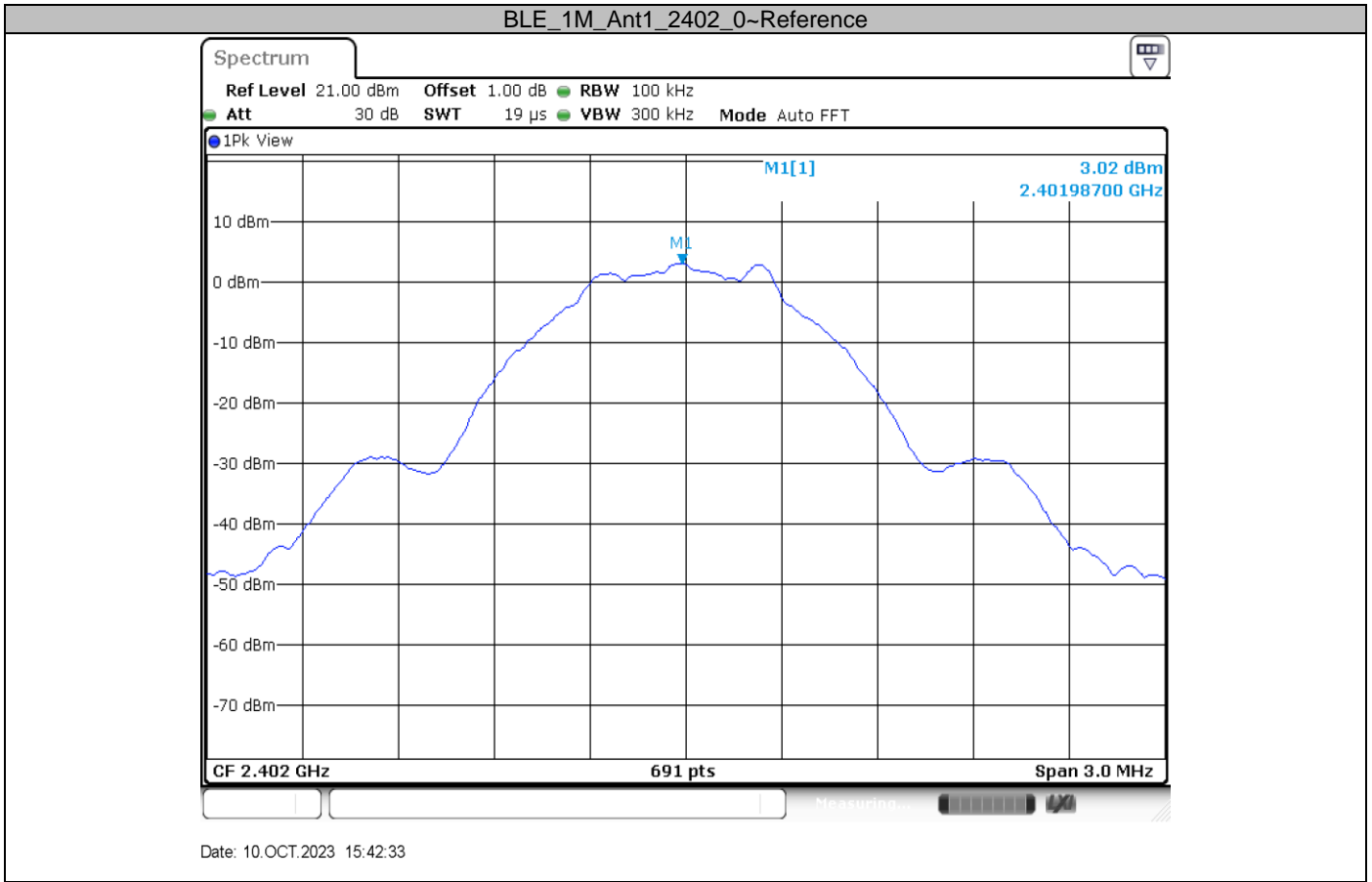

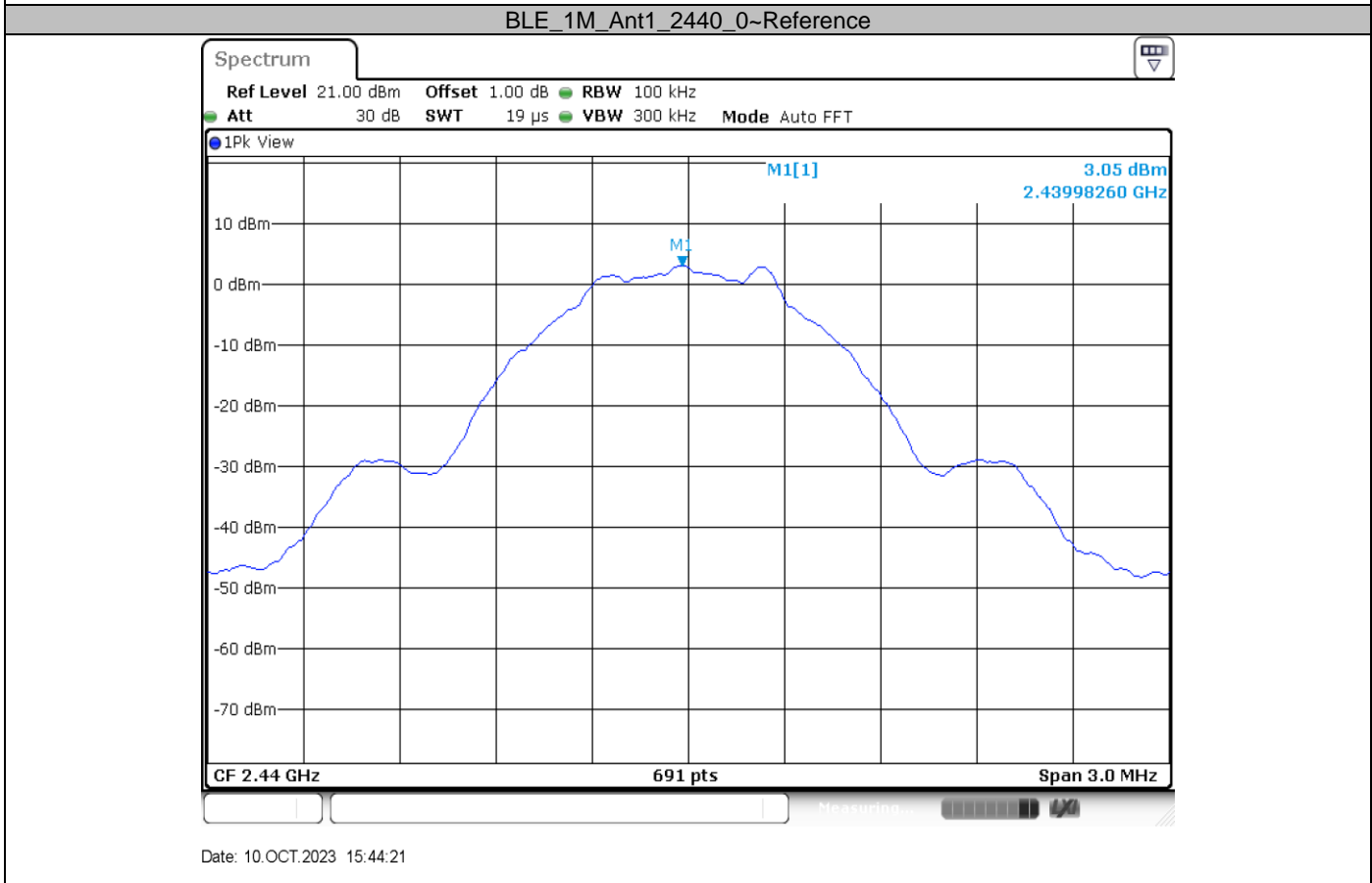
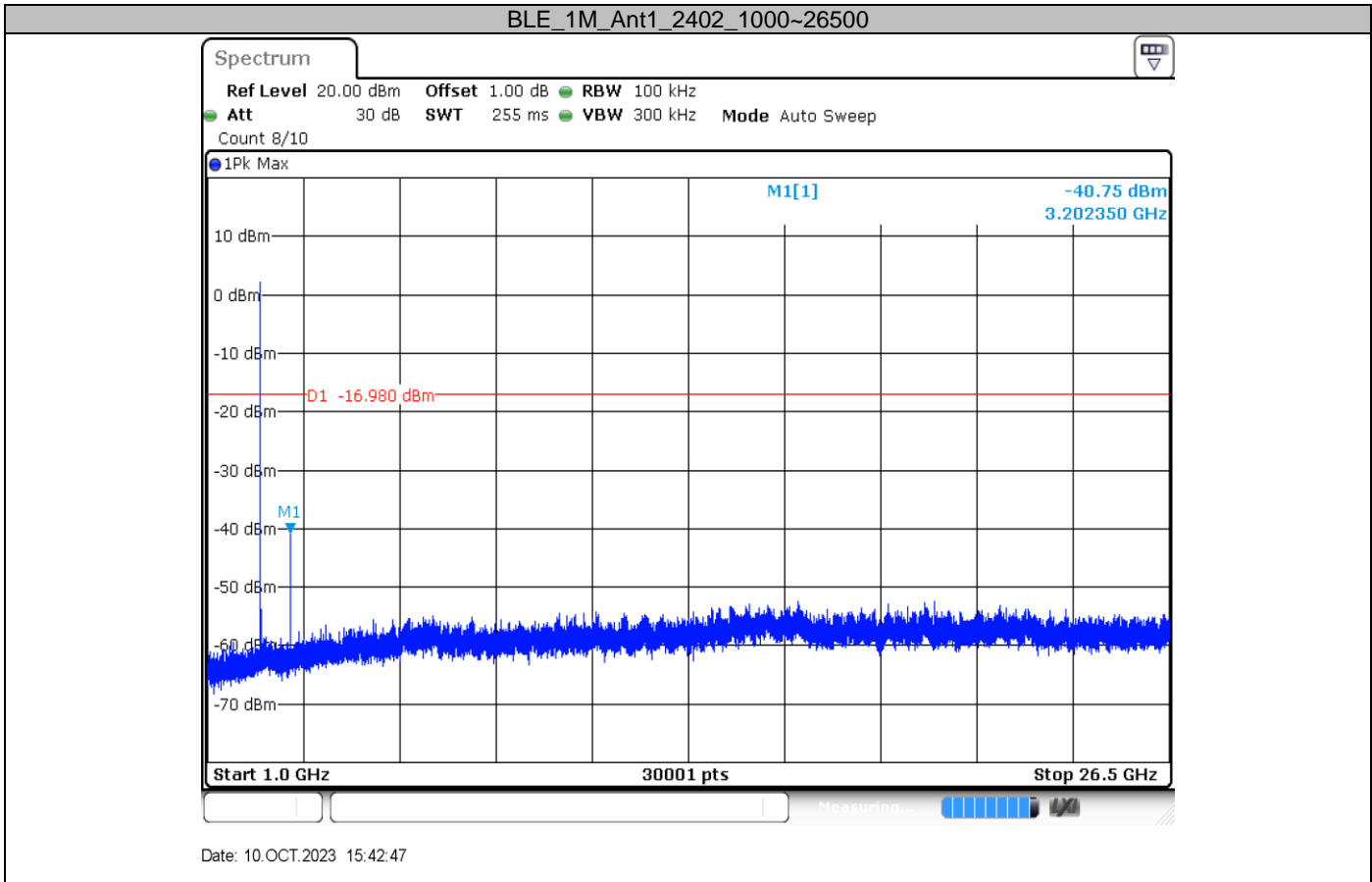

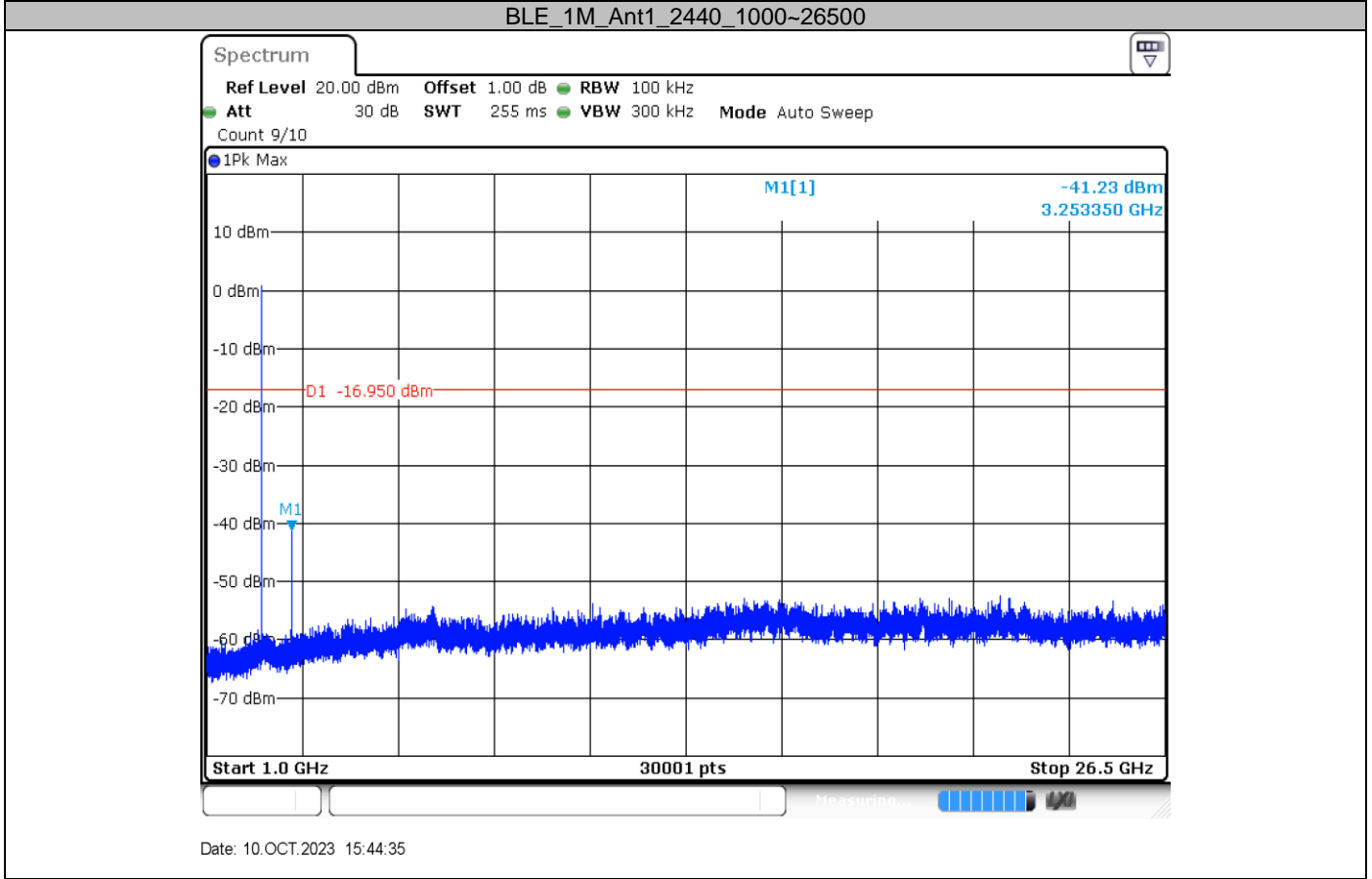
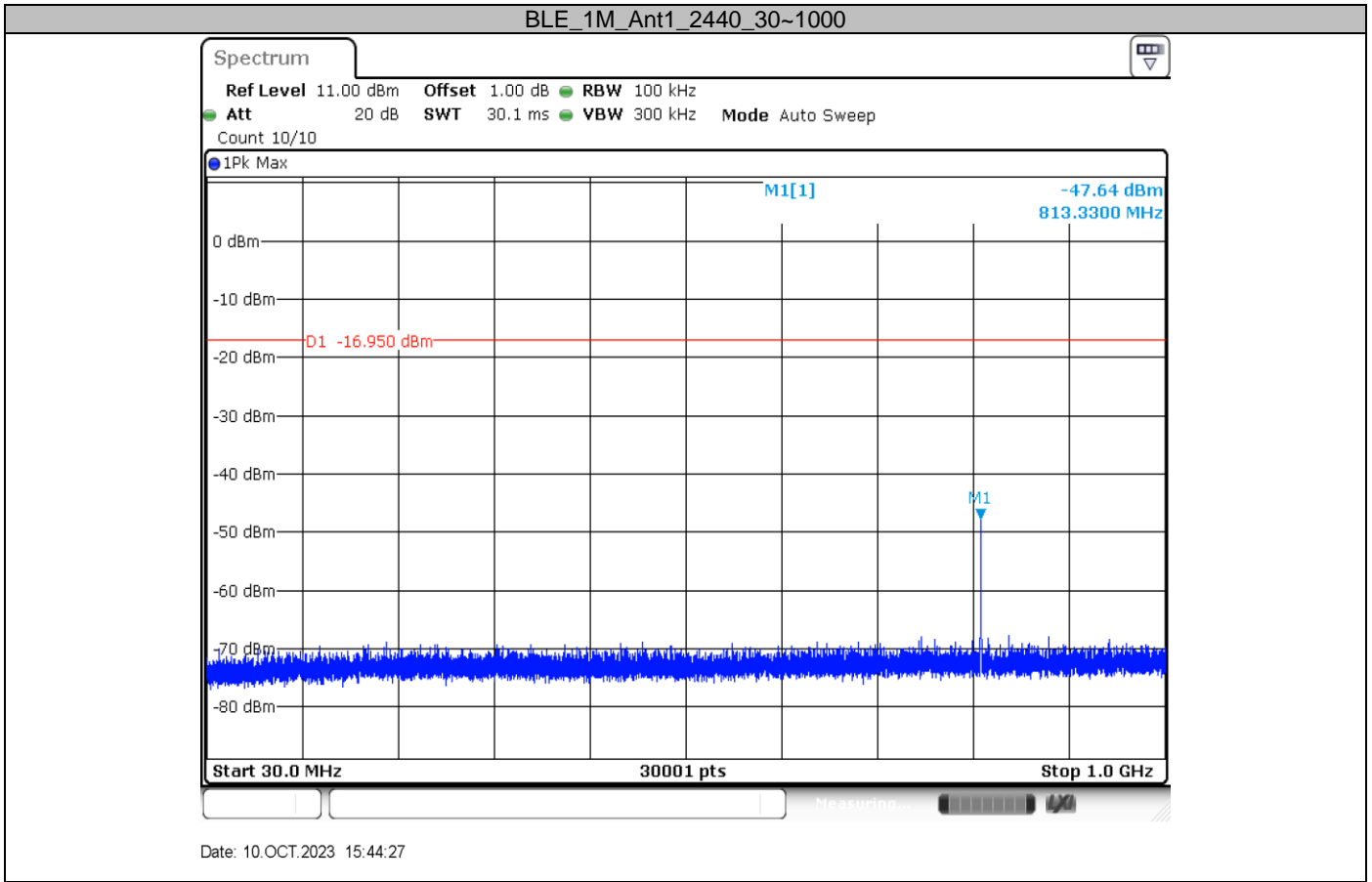

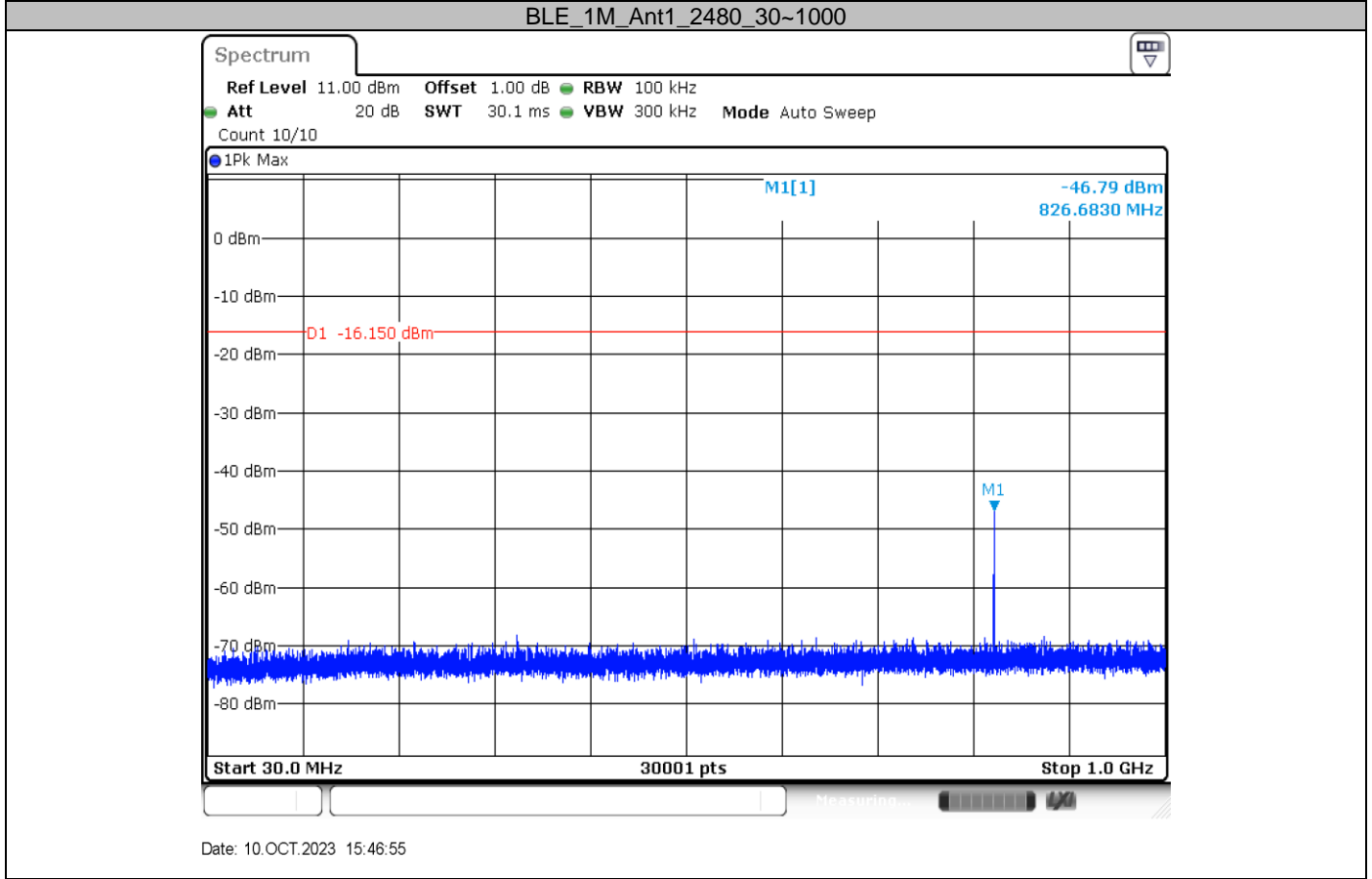
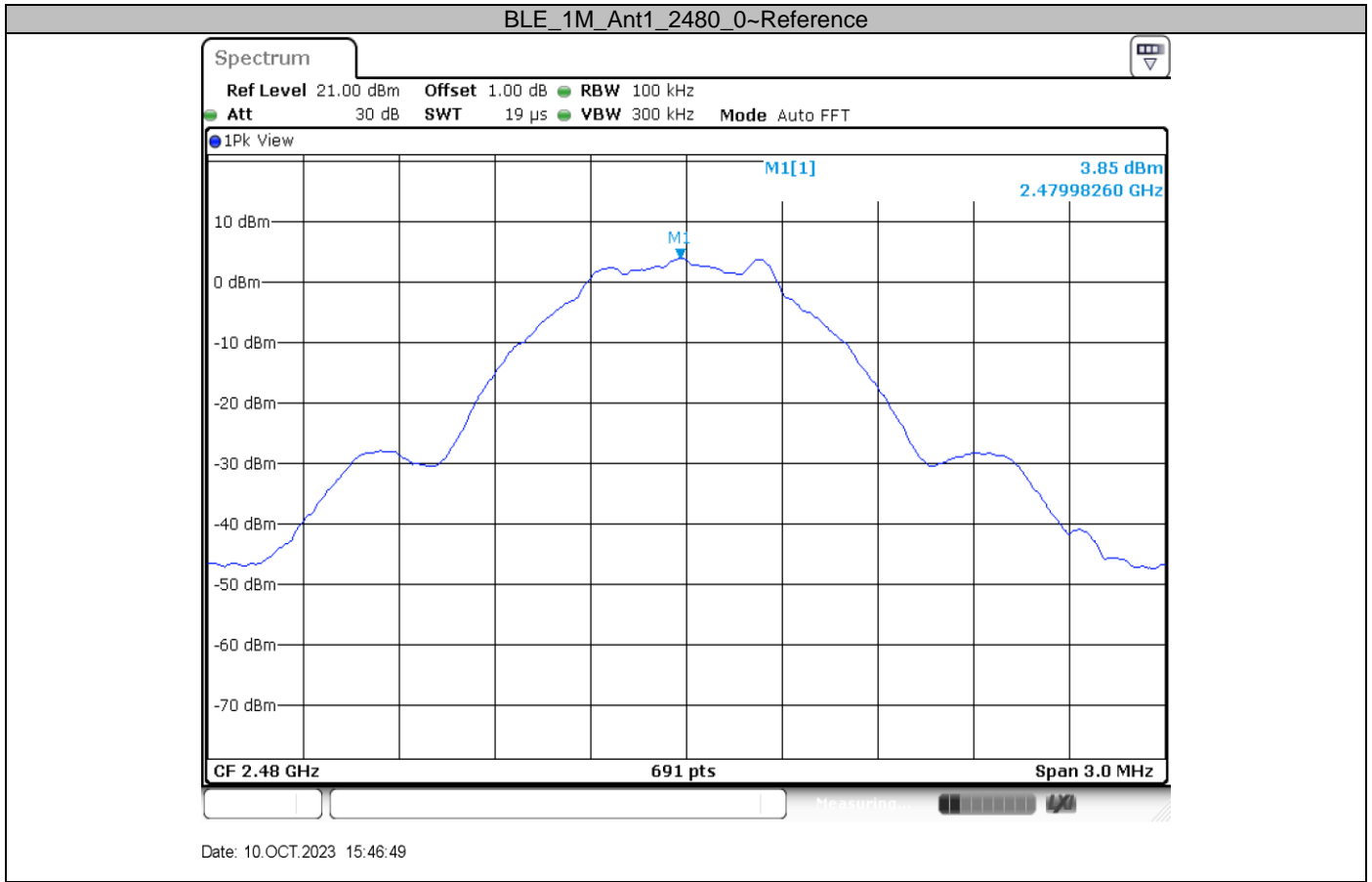

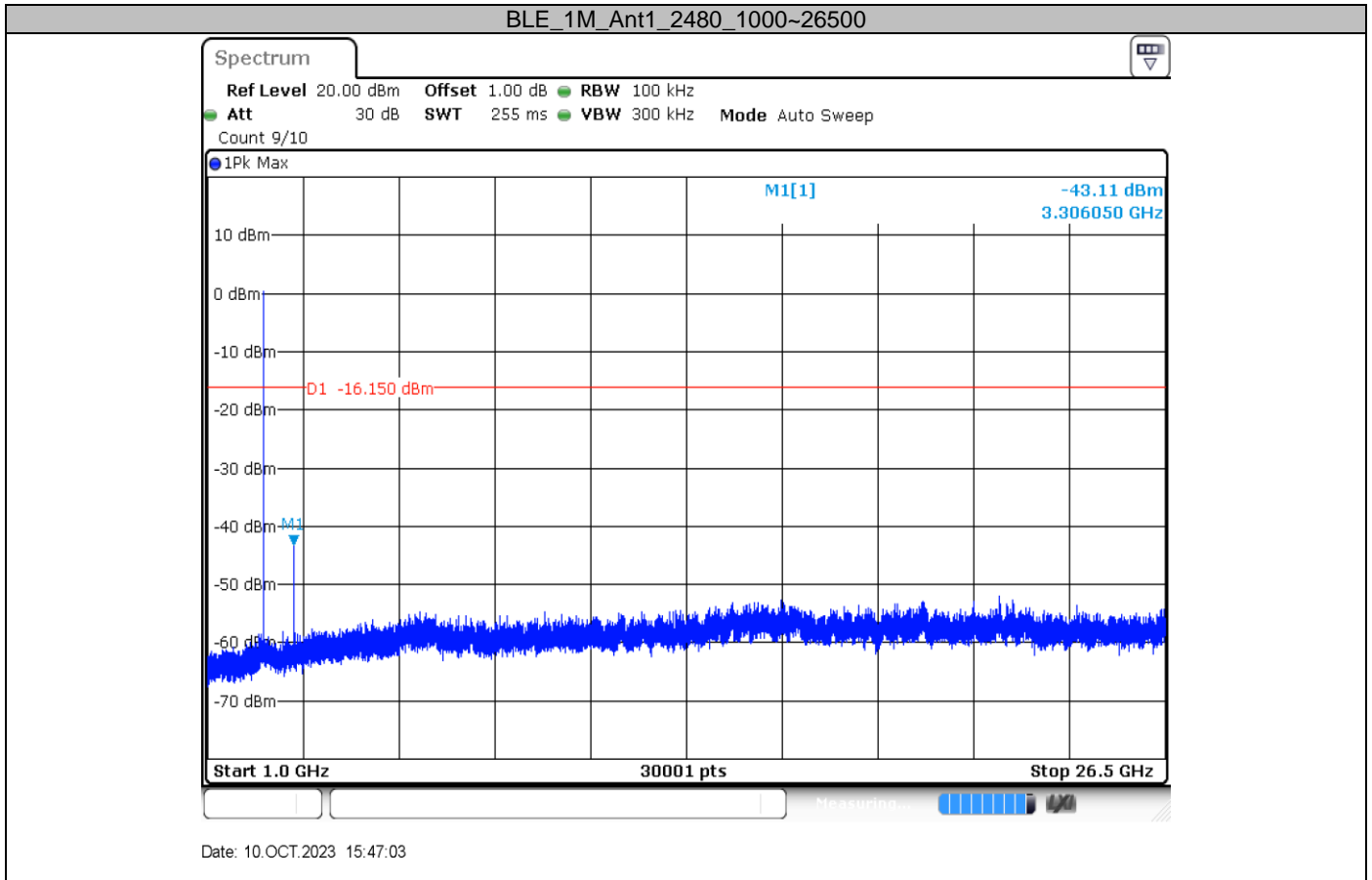

9.5 Band Edge

Test Method

1. The RF output of EUT was connected to the spectrum analyzer by RF cable. The path loss was compensated to the results for each measurement.
2. Set to the maximum power setting, the instrument center frequency is set to the nominal EUT channel center frequency enable the EUT transmit continuously.
3. Use the following spectrum analyzer settings:
Span = wide enough to capture the peak level of the in-band emission and all spurious
RBW = 100 kHz, VBW \geq 3RBW, Sweep = auto, Detector function = peak, Trace = max hold
4. Allow the trace to stabilize, use the peak and delta measurement to record the result.
5. The level displayed must comply with the limit specified in this Section.
6. Repeat above procedures until all frequencies measured were complete and submit all the plots.

Limit

Frequency Range MHz	Limit (dBc)
30-25000	-20

Band edge testing

TestMode	Channe	Channel (MHz)	Reference Level (dBm)	Result (dBm)	Limit (dBm)	Verdict
BLE_1M	Low	2402	2.74	-55.96	<=-17.26	PASS
	High	2480	3.98	-57.02	<=-16.02	PASS

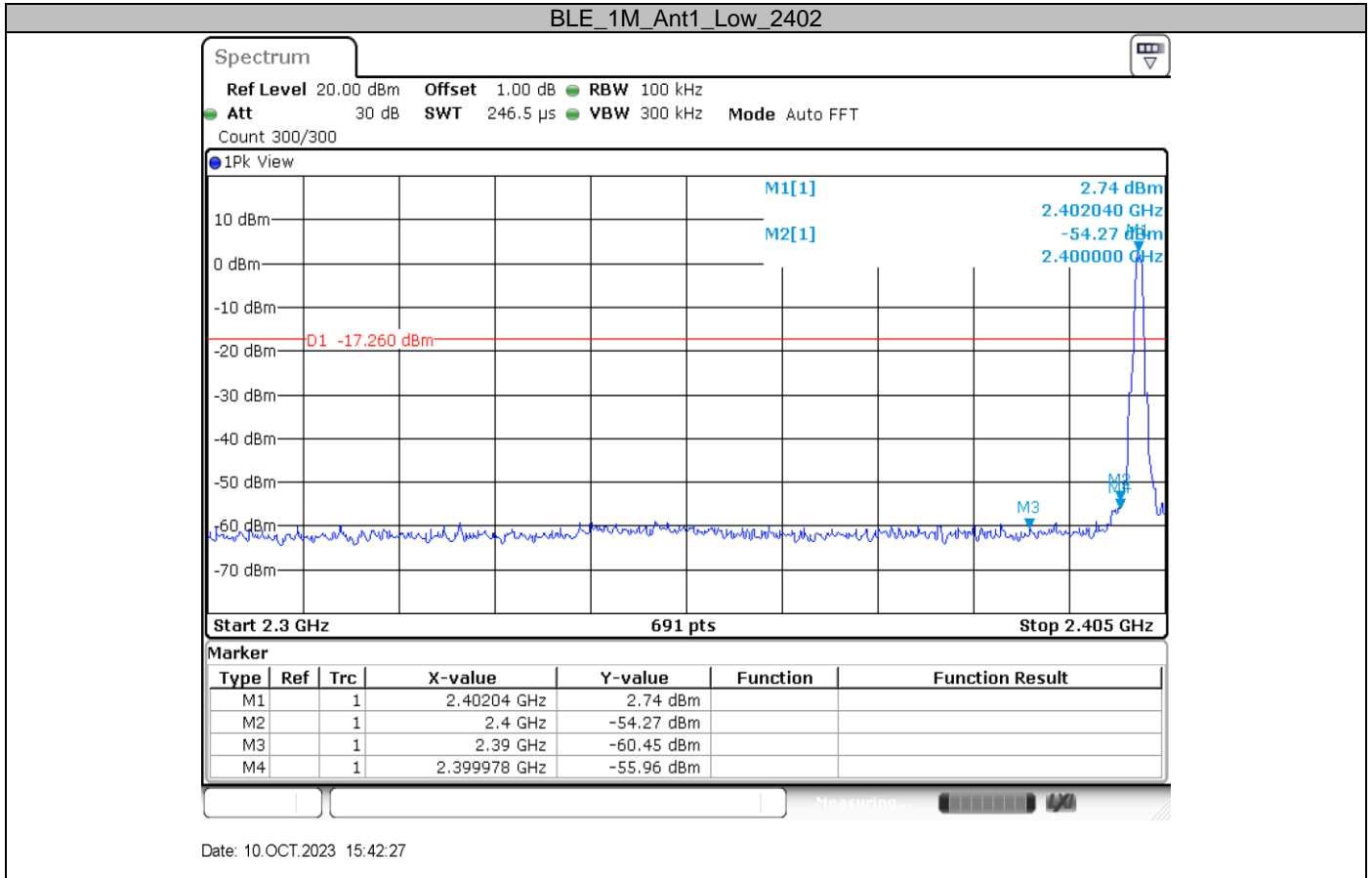

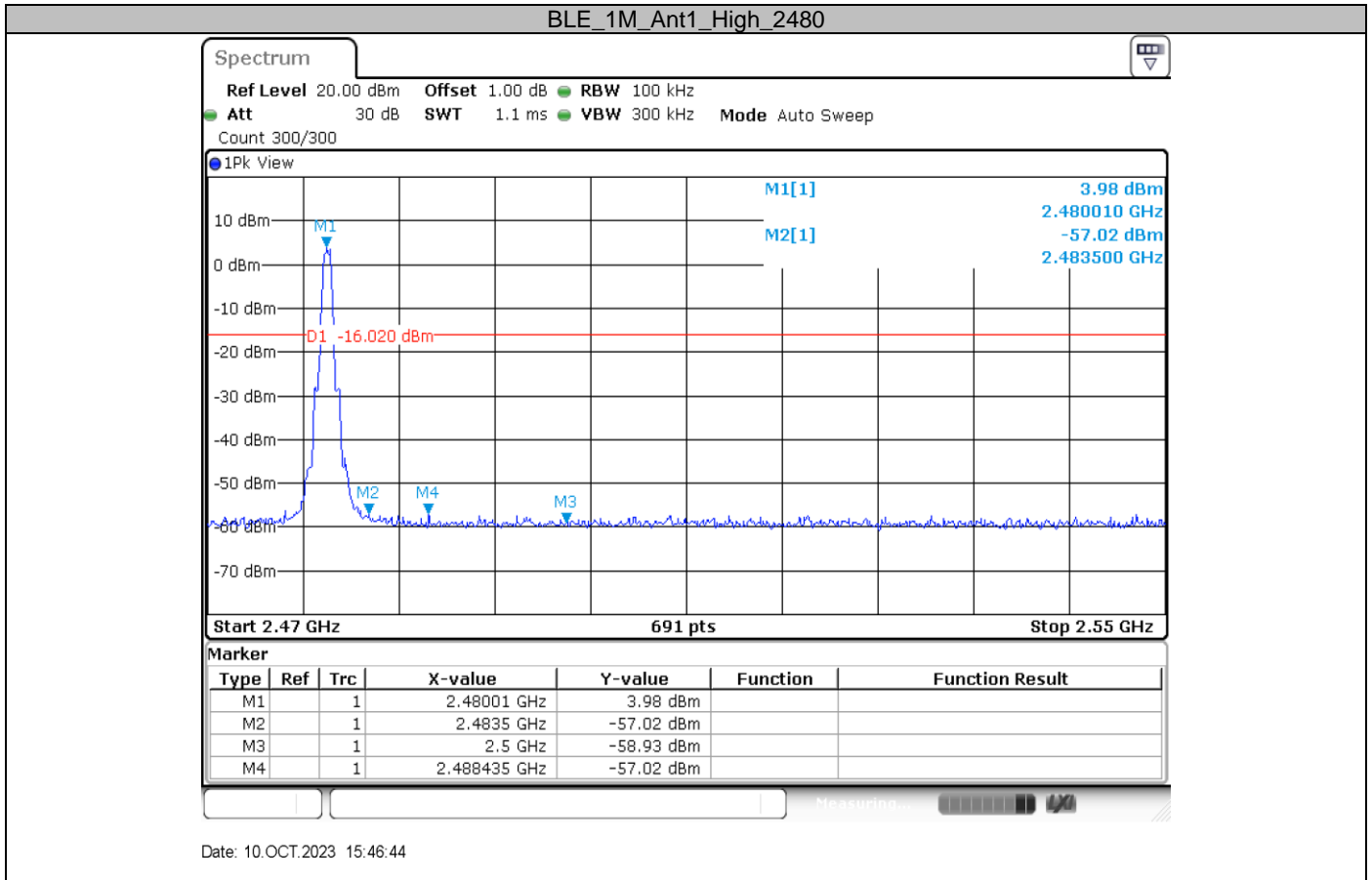

9.6 Spurious Radiated Emissions for Transmitter

Test Method

1. The EUT was placed on a turn table which is 1.5m above ground plane for above 1GHz and 0.8m above ground for below 1GHz at 3 meter chamber room for test. The table was rotated 360 degrees to determine the position of the highest radiation.
2. The EUT was set 3 meters away from the interference – receiving antenna, which was mounted on the top of a variable – height antenna tower.
3. The height of antenna is varied from one meter to four meters above the ground to determine the maximum value of the field strength. Both horizontal and vertical polarizations of the antenna are set to make the measurement.
4. For each suspected emission, the EUT was arranged to its worst case and then the antenna was tuned to heights from 1 meter to 4 meters and the rotatable table was turned from 0 degrees to 360 degrees to find the maximum reading.
5. Use the following spectrum analyzer settings According to C63.10:

For Below 1GHz

Use the following test receiver settings:

Span = wide enough to capture the peak level of the in-band emission and all spurious
 RBW = 100 KHz to 120KHz, VBW ≥ RBW for peak measurement, Sweep = auto, Detector function = peak, Trace = max hold.

For Peak unwanted emissions Above 1GHz:

Span = wide enough to capture the peak level of the in-band emission and all spurious
 RBW = 1MHz, VBW ≥ RBW for peak measurement, Sweep = auto, Detector function = peak, Trace = max hold.

Procedures for average unwanted emissions measurements above 1000 MHz

a) RBW = 1MHz.

b) VBW \ [3 × RBW].

c) Detector = RMS (power averaging), if [span / (# of points in sweep)] \ RBW / 2.

Satisfying this condition can require increasing the number of points in the sweep or reducing the span. If the condition is not satisfied, then the detector mode shall be set to peak.

d) Averaging type = power (i.e., rms) (As an alternative, the detector and averaging type may be set for linear voltage averaging. Some instruments require linear display mode to use linear voltage averaging. Log or dB averaging shall not be used.)

e) Sweep time = auto.

f) Perform a trace average of at least 100 traces if the transmission is continuous. If the transmission is not continuous, then the number of traces shall be increased by a factor of 1 / D, where D is the duty cycle. For example, with 50% duty cycle, at least 200 traces shall be averaged. (If a specific emission is demonstrated to be continuous—i.e., 100% duty cycle—then rather than turning ON and OFF with the transmit cycle, at least 100 traces shall be averaged.)

g) If tests are performed with the EUT transmitting at a duty cycle less than 98%, then a correction factor shall be added to the measurement results prior to comparing with the emission limit, to compute the emission level that would have been measured had the test been performed at 100% duty cycle. The correction factor is computed as follows:

1) If power averaging (rms) mode was used in the preceding step e), then the correction factor is [10 log (1 / D)], where D is the duty cycle. For example, if the transmit duty

cycle was 50%, then 3 dB shall be added to the measured emission levels.

2) If linear voltage averaging mode was used in the preceding step e), then the correction factor is $[20 \log (1 / D)]$, where D is the duty cycle. For example, if the transmit duty cycle was 50%, then 6 dB shall be added to the measured emission levels.

3) If a specific emission is demonstrated to be continuous (100% duty cycle) rather than turning ON and OFF with the transmit cycle, then no duty cycle correction is required for that emission (AV) at frequency above 1GHz.

Limit

The radio emission outside the operating frequency band shall be at least 20 dB below that in the 100 kHz bandwidth within the band that contains the highest level of the desired power. Radiated emissions which fall in the restricted bands, as defined in section 15.205, must comply with the radiated emission limits specified in section 15.209.

Frequency MHz	Field Strength $\mu\text{V/m}$	Field Strength $\text{dB}\mu\text{V/m}$	Detector	Measurement distance meters
0.009-0.490	2400/F(kHz)	48.5-13.8	AV	300
0.490-1.705	24000/F(kHz)	33.8-23.0	QP	30
1.705-30	30	29.5	QP	30
30-88	100	40	QP	3
88-216	150	43.5	QP	3
216-960	200	46	QP	3
960-1000	500	54	QP	3
Above 1000	500	54	AV	3
Above 1000	5000	74	PK	3

Note 1: $\text{Limit } 3\text{m}(\text{dB}\mu\text{V/m}) = \text{Limit } 300\text{m}(\text{dB}\mu\text{V/m}) + 40\text{Log}(300\text{m}/3\text{m})$ (Below 30MHz)

Note 2: $\text{Limit } 3\text{m}(\text{dB}\mu\text{V/m}) = \text{Limit } 30\text{m}(\text{dB}\mu\text{V/m}) + 40\text{Log}(30\text{m}/3\text{m})$ (Below 30MHz)

Spurious radiated emissions for transmitter

According to C63.10, if the peak (or quasi-peak) measured value complies with the average limit, it is unnecessary to perform an average measurement, so AV emission value did not show in below table if the peak value complies with average limit.

Transmitting spurious emission test result as below:

Test data_30MHz to 1000MHz

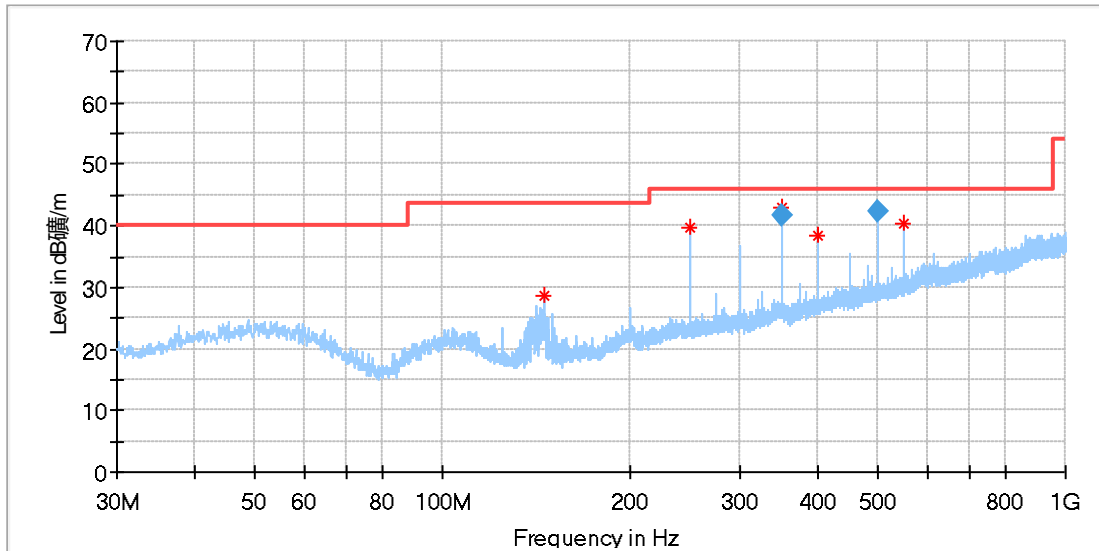

Critical Freqs

Frequency (MHz)	MaxPeak (dBµV/m)	Limit (dBµV/m)	Margin (dB)	Height (cm)	Pol	Azimuth (deg)	Corr. (dB/m)
145.248125	28.63	43.50	14.87	200.0	H	257.0	15.12
250.008125	39.63	46.00	6.37	100.0	H	86.0	20.32
350.001563	42.87	46.00	3.13	100.0	H	93.0	23.34
399.994375	38.40	46.00	7.60	100.0	H	270.0	23.99
500.003125	42.37	46.00	3.63	181.0	H	276.0	25.92
550.041250	40.37	46.00	5.63	200.0	H	304.0	26.68

Final Result

Frequency (MHz)	QuasiPeak (dBµV/m)	Limit (dBµV/m)	Margin (dB)	Height (cm)	Pol	Azimuth (deg)	Corr. (dB/m)
350.001563	41.73	46.00	4.27	100.0	H	93.0	23.34
500.003125	42.44	46.00	3.56	181.0	H	276.0	25.92

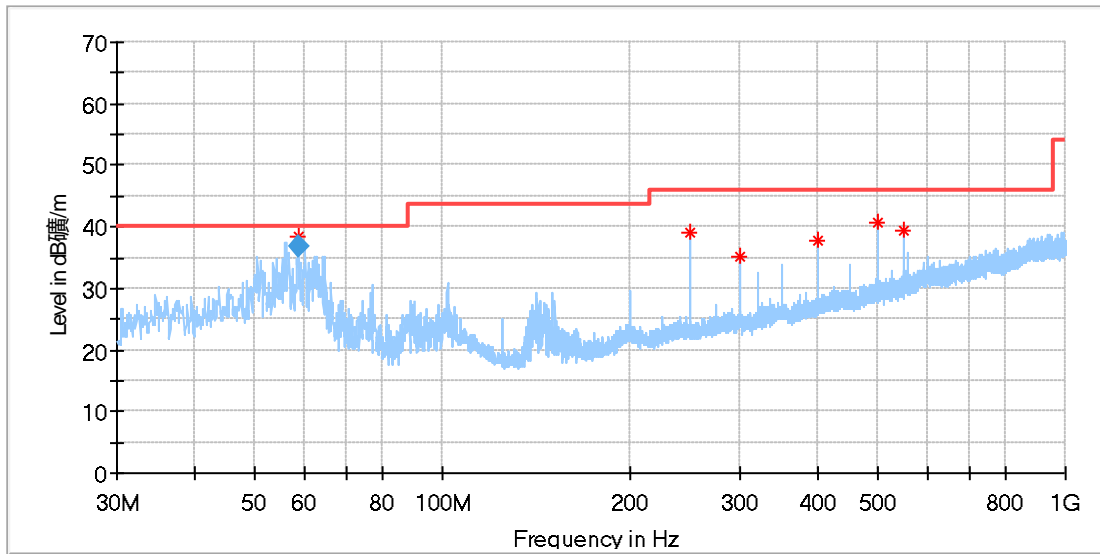

Critical_Freqs

Frequency (MHz)	MaxPeak (dBµV/m)	Limit (dBµV/m)	Margin (dB)	Height (cm)	Pol	Azimuth (deg)	Corr. (dB/m)
58.712188	38.32	40.00	1.68	100.0	V	199.0	19.93
250.008125	38.91	46.00	7.09	100.0	V	220.0	20.32
299.963125	35.20	46.00	10.80	200.0	V	286.0	21.33
399.994375	37.86	46.00	8.14	100.0	V	331.0	23.99
500.025625	40.78	46.00	5.22	100.0	V	0.0	25.92
549.980625	39.40	46.00	6.60	100.0	V	237.0	26.68

Final Result

Frequency (MHz)	QuasiPeak (dBµV/m)	Limit (dBµV/m)	Margin (dB)	Height (cm)	Pol	Azimuth (deg)	Corr. (dB/m)
58.712188	36.67	40.00	2.33	100.0	V	199.0	19.92

Test data 1GHz to 18GHz:
BLE_1Mbps_Low Channel:

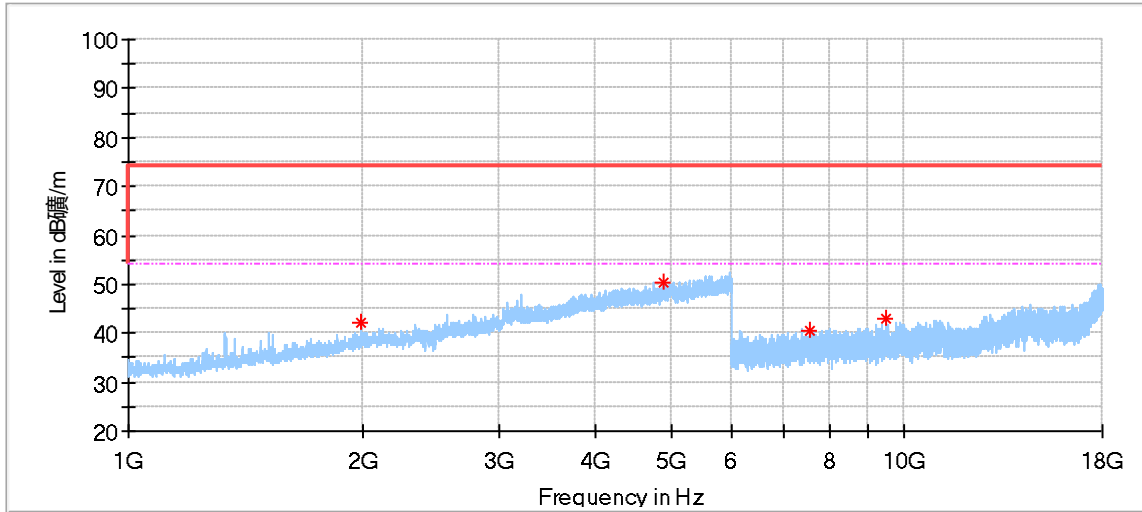

Frequency (MHz)	MaxPeak (dBµV/m)	Limit (dBµV/m)	Margin (dB)	Height (cm)	Pol	Azimuth (deg)	Corr. (dB/m)
1994.500000	42.10	74.00	31.90	150.0	H	0.0	-6.21
4881.000000*	50.56	74.00	23.44	150.0	H	347.0	5.64
7536.500000*	40.46	74.00	33.54	150.0	H	265.0	8.66
9489.500000*	42.93	74.00	31.07	150.0	H	70.0	11.09

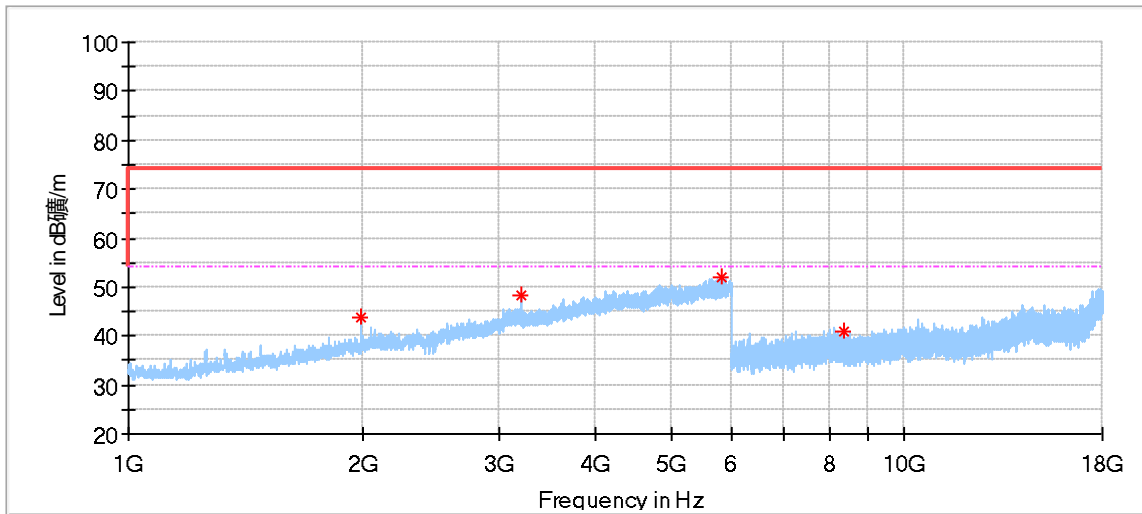

Frequency (MHz)	MaxPeak (dBµV/m)	Limit (dBµV/m)	Margin (dB)	Height (cm)	Pol	Azimuth (deg)	Corr. (dB/m)
1991.500000	43.63	74.00	30.37	150.0	V	347.0	-6.27
3203.000000	48.18	74.00	25.82	150.0	V	214.0	-0.26
5803.000000	51.91	74.00	22.09	150.0	V	57.0	7.64
8357.000000*	40.92	74.00	33.08	150.0	V	158.0	9.52

BLE_1Mbps _Middle Channel:

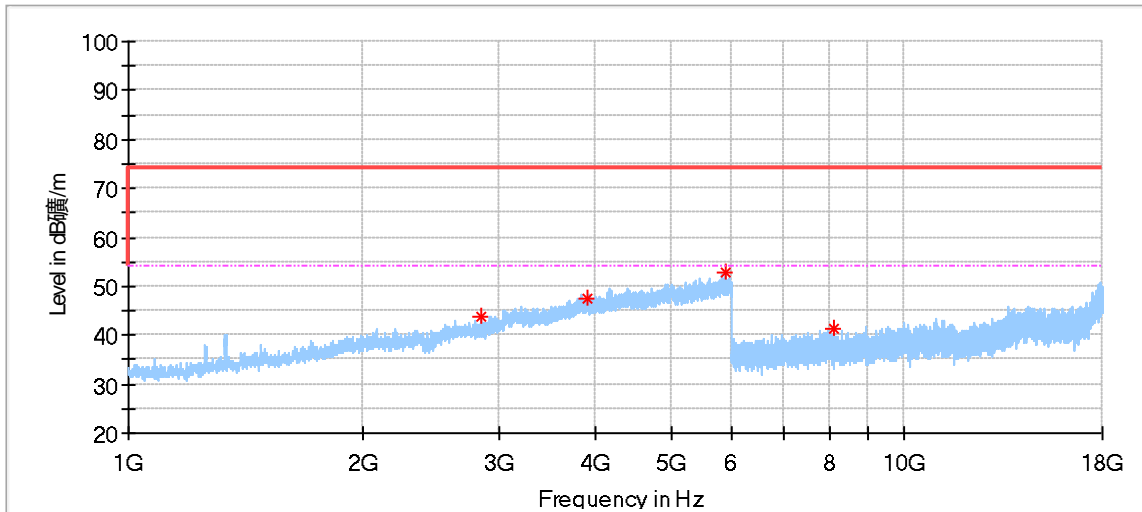

Frequency (MHz)	MaxPeak (dBµV/m)	Limit (dBµV/m)	Margin (dB)	Height (cm)	Pol	Azimuth (deg)	Corr. (dB/m)
2842.000000*	43.96	74.00	30.04	150.0	H	347.0	-2.80
3901.500000*	47.54	74.00	26.46	150.0	H	275.0	2.96
5873.000000	52.70	74.00	21.30	150.0	H	78.0	7.98
8094.500000	41.52	74.00	32.48	150.0	H	222.0	9.42

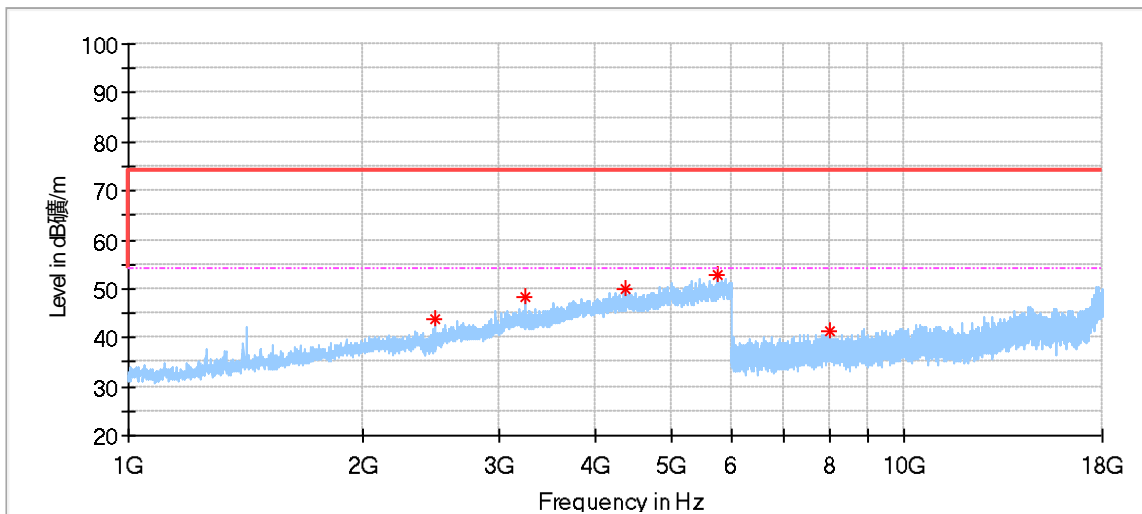

Frequency (MHz)	MaxPeak (dBµV/m)	Limit (dBµV/m)	Margin (dB)	Height (cm)	Pol	Azimuth (deg)	Corr. (dB/m)
2479.500000	43.99	74.00	30.01	150.0	V	191.0	-4.28
3253.000000	48.40	74.00	25.60	150.0	V	263.0	-0.41
4378.500000*	50.02	74.00	23.98	150.0	V	109.0	4.26
5739.500000	52.77	74.00	21.23	150.0	V	99.0	7.40
8003.500000*	41.47	74.00	32.53	150.0	V	156.0	9.30

BLE_1Mbps _High Channel:

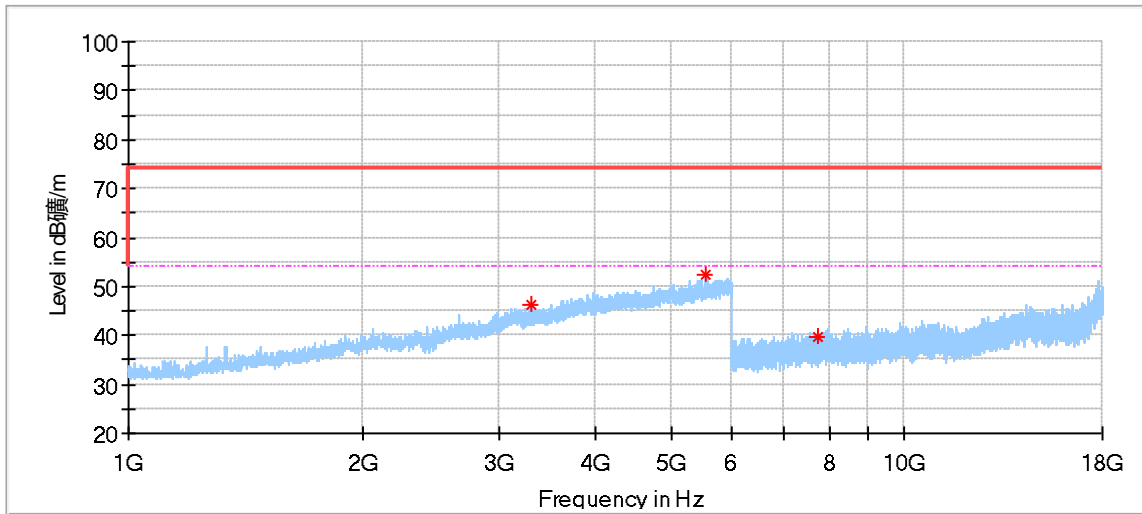

Frequency (MHz)	MaxPeak (dBµV/m)	Limit (dBµV/m)	Margin (dB)	Height (cm)	Pol	Azimuth (deg)	Corr. (dB/m)
3306.500000	46.10	74.00	27.90	150.0	H	183.0	-0.30
5551.000000	52.58	74.00	21.42	150.0	H	255.0	7.28
7730.000000	39.82	74.00	34.18	150.0	H	261.0	8.92

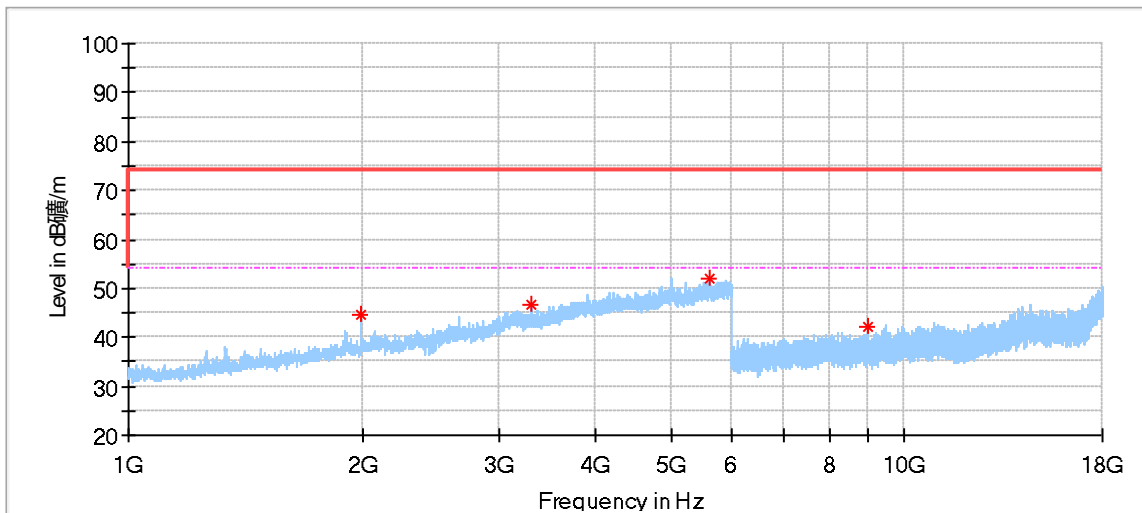

Frequency (MHz)	MaxPeak (dBµV/m)	Limit (dBµV/m)	Margin (dB)	Height (cm)	Pol	Azimuth (deg)	Corr. (dB/m)
1996.500000	44.74	74.00	29.26	150.0	V	356.0	-6.18
3306.500000	46.68	74.00	27.32	150.0	V	2.0	-0.30
5611.000000	52.05	74.00	21.95	150.0	V	88.0	7.26
8985.000000	42.04	74.00	31.96	150.0	V	326.0	10.26

Remark:

- (1) "*" means the emission(s) appear within the restrict bands shall follow the requirement RSS-GEN 8.10.
- (2) Data of measurement within frequency range 9kHz-30MHz, 18-26GHz are the noise floor or attenuated more than 20dB below the permissible limits or the field strength is too small to be measured, so test data does not present in this report.
- (3) The report only shows the worst test data.
- (4) Corrected Amplitude = Read level + Corrector factor
 Above 1GHz: Corrector factor = Antenna Factor + Cable Loss- Amplifier Gain
 Below 1GHz: Corrector factor = Antenna Factor + Cable Loss
 (The Reading Level is recorded by software which is not shown in the sheet)

10 Test Equipment List

List of Test Instruments

Radiated Emission Test(9K – 30MHz)

Description	Manufacturer	Model no.	Equipment ID	Serial no.	cal interval (year)	cal. due date
EMI Test Receiver	Rohde & Schwarz	ESR 26	68-4-74-14-002	101269	1	2024-5-20
Trilog Super Broadband Test Antenna	Schwarzbeck	VULB 9163	68-4-80-14-002	707	1	2024-7-18
Loop Antenna	Rohde & Schwarz	HFH2-Z2	68-4-80-14-006	100398	1	2024-5-28
Pre-amplifier	Rohde & Schwarz	SCU 18	68-4-29-14-001	102230	1	2024-8-7
Attenuator	Mini-circuits	UNAT-6+	68-4-81-21-002	15542	1	2024-5-19
3m Semi-anechoic chamber	TDK	SAC-3 #2	68-4-90-19-006	----	2	2024-5-19
Test software	Rohde & Schwarz	EMC32	68-4-90-19-006-A01	Version10.35.02	N/A	N/A

Radiated Emission 2# Test(30MHz – 40GHz)

DESCRIPTION	MANUFACTURER	MODEL NO.	EQUIPMENT ID	SERIAL NO.	CAL INTERVAL (YEAR)	CAL. DUE DATE
EMI Test Receiver	Rohde & Schwarz	ESR 26	68-4-74-14-002	101269	1	2024-5-20
Wave Guide Antenna	ETS	3117	68-4-80-19-001	00218954	1	2024-3-5
Pre-amplifier	Rohde & Schwarz	SCU 18F	68-4-29-19-001	100745	1	2024-4-26
Pre-amplifier	Rohde & Schwarz	SCU 18F	68-4-29-19-002	100746	1	2024-5-19
Sideband Horn Antenna	Q-PAR	QWH-SL-18-40-K-SG	68-4-80-14-008	12827	1	2024-5-19
Pre-amplifier	Rohde & Schwarz	SCU 40A	68-4-29-14-002	100432	1	2024-7-11
Attenuator	Mini-circuits	UNAT-6+	68-4-81-21-002	15542	1	2024-8-1
3m Semi-anechoic chamber	TDK	SAC-3 #2	68-4-90-19-006	----	2	2024-5-19
Test software	Rohde & Schwarz	EMC32	68-4-90-19-006-A01	Version10.35.02	N/A	N/A

Conducted Emission 2# Test

DESCRIPTION	MANUFACTURER	MODEL NO.	EQUIPMENT ID	SERIAL NO.	CAL INTERVAL (YEAR)	CAL. DUE DATE
EMI Test Receiver	Rohde & Schwarz	ESR 3	68-4-74-19-002	102590	1	2024-5-19
LISN	Rohde & Schwarz	ENV216	68-4-87-19-001	102472	1	2024-5-20
Attenuator	Shanghai Huaxiang	TS2-26-3	68-4-81-16-003	080928189	1	2024-5-19
Test software	Rohde & Schwarz	EMC32	68-4-90-19-005-A01	Version10.35.02	N/A	N/A
Shielding Room	TDK	CSR #2	68-4-90-19-005	----	3	2025-10-15



Conducted RF Test System

DESCRIPTION	MANUFACTURER	MODEL NO.	EQUIPMENT ID	SERIAL NO.	CAL INTERVAL (YEAR)	CAL. DUE DATE
Signal Analyzer	Rohde & Schwarz	FSV40	68-4-74-14-004	101030	1	2024-5-19
Test software	Tonscend	System for BT/WIFI	68-4-74-14-006-A13	Version 2.6.77.0518	N/A	N/A
Shielding Room	TDK	TS8997	68-4-90-19-003	----	3	2025-10-15

11 System Measurement Uncertainty

For a 95% confidence level, the measurement expanded uncertainties for defined systems, in accordance with the recommendations of ISO 17025 were:

System Measurement Uncertainty	
Test Items	Extended Uncertainty
Uncertainty for Conducted Emission 150kHz-30MHz (for test using AMN ENV432)	3.15dB
Uncertainty for Radiated Spurious Emission 9kHz-30MHz	4.70dB
Uncertainty for Radiated Spurious Emission 30MHz-1000MHz	Horizontal: 4.79dB; Vertical: 4.79dB;
Uncertainty for Radiated Spurious Emission 1000MHz-18000MHz	5.11dB;
Uncertainty for Radiated Spurious Emission 18000MHz-40000MHz	5.10dB;
Uncertainty for Conducted RF test with TS 8997	RF Power Conducted: 1.31dB Frequency test involved: 0.6×10^{-8} or 1%

Measurement Uncertainty Decision Rule:

Determination of conformity with the specification limits is based on the decision rule according to IEC Guide 115: 2021, clause 4.4.3 and 4.5.1.

---THE END OF REPORT---