



# TEST REPORT

**APPLICANT** : Anker Innovations Limited

**PRODUCT NAME** : Nebula Capsule Air

**MODEL NAME** : D4112

**BRAND NAME** : NEBULA

**FCC ID** : 2AOKB-D4112

**STANDARD(S)** : 47 CFR Part 15 Subpart E

**RECEIPT DATE** : 2024-04-10

**TEST DATE** : 2024-04-19 to 2024-05-09

**ISSUE DATE** : 2024-05-20



Edited by: Zeng Xiaoying  
Zeng Xiaoying (Rapporteur)

Approved by: Shen Junsheng  
Shen Junsheng (Supervisor)

**NOTE:** This document is issued by Shenzhen Morlab Communications Technology Co., Ltd., the test report shall not be reproduced except in full without prior written permission of the company. The test results apply only to the particular sample(s) tested and to the specific tests carried out which is available on request for validation and information confirmed at our website.





# DIRECTORY

<b>1. Summary of Test Result</b>	<b>4</b>
1.1. Testing Applied Standards	5
1.2. Test Equipment List	6
1.3. Measurement Uncertainty	7
1.4. Testing Laboratory	8
<b>2. General Description</b>	<b>9</b>
2.1. Information of Applicant and Manufacturer	9
2.2. Information of EUT	9
2.3. Channel List of EUT	11
2.4. Test Configuration of EUT	12
2.5. Test Conditions	12
2.6. Test Setup Layout Diagram	13
<b>3. Test Results</b>	<b>16</b>
3.1. Antenna Requirement	16
3.2. Duty Cycle of Test Signal	17
3.3. Maximum Conducted Output Power	18
3.4. Emission Bandwidth	20
3.5. Peak Power Spectral Density	22
3.6. Frequency Stability	23
3.7. Dynamic Frequency Selection	24
3.8. Conducted Emission	29
3.9. Restricted Frequency Bands	30
3.10. Radiated Emission	32
<b>Annex A Test Data and Result</b>	<b>34</b>



Change History		
Version	Date	Reason for change
1.0	2024-05-20	First edition

# 1. Summary of Test Result

No.	Section	Description	Test Date	Test Engineer	Result	Method Determination /Remark
1	15.203	Antenna Requirement	N/A	N/A	PASS	No deviation
2	ANSI C63.10	Duty Cycle of the Test Signal	Apr. 20, 2024	He Yuyang	PASS	No deviation
3	15.407(a)	Maximum Conducted Output Power	Apr. 20, 2024	He Yuyang	PASS	No deviation
4	15.407(a)(e)	Emission Bandwidth	Apr. 20, 2024	He Yuyang	PASS	No deviation
5	15.407(a)	Peak Power Spectral Density	Apr. 20, 2024	He Yuyang	PASS	No deviation
6	15.407(g)	Frequency Stability	May 08, 2024	He Yuyang	PASS	No deviation
7	15.407(h)	DFS	Apr. 19, 2024	He Yuyang	PASS	No deviation
8	15.207	Conducted Emission	Apr. 29, 2024	Wang Deyong	PASS	No deviation
9	15.407(b)	Restricted Frequency Bands	May 04, 2024	Gao Jianrou	PASS	No deviation
10	15.407(b)	Radiated Emission	May 03&04, 2024	Gao Jianrou	PASS	No deviation

**Note 1:** The tests of Conducted Emission and Radiated Emission were performed according to the method of measurements prescribed in ANSI C63.10 2013.

**Note 2:** These RF tests were performed according to the method of measurements prescribed in KDB 789033 D02 v02r01.

**Note 3:** These RF tests were performed according to the method of measurements prescribed in KDB 905462 D02 UNII DFS Compliance Procedures New Rules v02.

**Note 4:** Additions to, deviation, or exclusions from the method shall be judged in the "method determination" column of add, deviate or exclude from the specific method shall be explained in the "Remark" of the above table.

**Note 5:** When the test result is a critical value, we will use the measurement uncertainty give the judgment result based on the 95% confidence intervals.



## 1.1. Testing Applied Standards

According to the specifications of the manufacturer, the EUT must comply with the requirements of the following standards:

- 47 CFR Part 15 Subpart E Radio Frequency Devices



## 1.2. Test Equipment List

### 1.2.1 Conducted Test Equipment

Equipment Name	Serial No.	Type	Manufacturer	Cal. Date	Due Date
EXA Signal Analyzer	MY53470836	N9010A	Agilent	2024.02.19	2025.02.18
USB Wideband Power Sensor	MY54180008	U2021XA	Agilent	2023.10.17	2024.10.16
Temperature Chamber	12108015	DTL-003S101	YOMA	2023.09.19	2024.09.18
RF Cable (30MHz-26GHz)	CB01	RF01	Morlab	N/A	N/A
Coaxial Cable	CB02	RF02	Morlab	N/A	N/A
SMA Connector	CN01	RF03	HUBER-SUHNER	N/A	N/A
Attenuator	MTJ6004-10	10dB	MTJ cooperation	N/A	N/A

### 1.2.2 Conducted Emission Test Equipment

Equipment Name	Serial No.	Type	Manufacturer	Cal. Date	Due Date
Receiver	MY56400093	N9038A	KEYSIGHT	2024.01.25	2025.01.24
LISN	8127449	NSLK 8127	Schwarzbeck	2024.02.02	2025.02.01
Pulse Limiter (10dB)	VTSD 9561 F-B #206	VTSD 9561-F	Schwarzbeck	2023.06.27	2024.06.26
RF Coaxial Cable (DC-100MHz)	BNC	MRE04	Qualwave	N/A	N/A

### 1.2.3 List of Software Used

Description	Manufacturer	Software Version
Test System	MaiWei	2.0.0.0
Morlab EMCR	Morlab	V1.2
TS+ -[JS32-CE]	Tonscend	V2.5.0.0

**1.2.4 Radiated Test Equipment**

Equipment Name	Serial No.	Type	Manufacturer	Cal. Date	Due Date
Receiver	MY54130016	N9038A	Agilent	2023.06.21	2024.06.20
Test Antenna - Bi-Log	9163-519	VULB 9163	Schwarzbeck	2023.07.01	2024.06.30
Test Antenna - Loop	1519-022	FMZB1519	Schwarzbeck	2023.06.26	2024.06.25
Test Antenna – Horn	01774	BBHA 9120D	Schwarzbeck	2023.07.01	2024.06.30
Test Antenna – Horn	BBHA9170 #773	BBHA9170	Schwarzbeck	2023.07.01	2024.06.30
Preamplifier (10MHz-6GHz)	46732	S10M100L38 02	LUCIX CORP.	2023.06.27	2024.06.26
Preamplifier (2GHz-18GHz)	61171/61172	S020180L32 03	LUCIX CORP.	2023.06.27	2024.06.26
Preamplifier (18GHz-40GHz)	DS77209	DCLNA0118- 40C-S	Decentest	2023.07.04	2024.07.03
RF Coaxial Cable (DC-18GHz)	MRE001	PE330	Pasternack	2023.06.27	2024.06.26
RF Coaxial Cable (DC-18GHz)	MRE002	CLU18	Pasternack	2023.06.27	2024.06.26
RF Coaxial Cable (DC-18GHz)	MRE003	CLU18	Pasternack	2023.06.27	2024.06.26
RF Coaxial Cable (DC-40GHz)	22290045	QA360-40- KK-0.5	Qualwave	2023.07.04	2024.07.03
RF Coaxial Cable (DC-40GHz)	22290046	QA360-40- KKF-2	Qualwave	2023.07.04	2024.07.03
RF Coaxial Cable (DC-18GHz)	22120181	QA500-18- NN-5	Qualwave	2023.07.04	2024.07.03
Notch Filter	N/A	WRCG-2400- 2483.5-60SS	Wainwright	N/A	N/A
Anechoic Chamber	N/A	9m*6m*6m	CRT	2022.05.10	2025.05.09



### 1.3. Measurement Uncertainty

Test Items	Uncertainty	Remark
Peak Output Power	±2.22dB	Confidence levels of 95%
Power Spectral Density	±2.22dB	Confidence levels of 95%
Bandwidth	±5%	Confidence levels of 95%
Restricted Frequency Bands	±5%	Confidence levels of 95%
Radiated Emission	±2.95dB	Confidence levels of 95%
Conducted Emission	±2.44dB	Confidence levels of 95%

### 1.4. Testing Laboratory

Laboratory Name	Shenzhen Morlab Communications Technology Co., Ltd.
Laboratory Address	FL.3, Building A, FeiYang Science Park, No.8 LongChang Road, Block 67, BaoAn District, ShenZhen, GuangDong Province, P. R. China
Telephone	+86 755 36698555
Facsimile	+86 755 36698525
FCC Designation Number	CN1192
FCC Test Firm Registration Number	226174





## 2. General Description

### 2.1. Information of Applicant and Manufacturer

<b>Applicant</b>	Anker Innovations Limited
<b>Applicant Address</b>	Room 1318-19, Hollywood Plaza, 610 Nathan Road, Mongkok, Kowloon, Hong Kong
<b>Manufacturer</b>	Anker Innovations Limited
<b>Manufacturer Address</b>	Room 1318-19, Hollywood Plaza, 610 Nathan Road, Mongkok, Kowloon, Hong Kong

### 2.2. Information of EUT

<b>Product Name:</b>	Nebula Capsule Air	
<b>Sample No.:</b>	1#	
<b>Hardware Version:</b>	V3	
<b>Software Version:</b>	V11.0.43.2	
<b>Modulation Technology:</b>	OFDM	
<b>Modulation Mode:</b>	802.11a, 802.11n (HT20), 802.11n (HT40) 802.11ac (VHT20), 802.11ac (VHT40), 802.11ac (VHT80)	
<b>Operating Frequency Range:</b>	5180MHz-5240MHz; 5260MHz-5320MHz; 5500MHz-5720MHz; 5745MHz-5825MHz	
<b>Antenna Type:</b>	FPC Antenna	
<b>Antenna Gain:</b>	ANT 1: 5.24dBi; ANT 2: 3.75dBi	
<b>Directional Gain:</b>	7.54dBi <small>Note 2</small>	
<b>Accessory Information:</b>	Battery	
	<b>Brand Name:</b>	N/A
	<b>Model No.:</b>	LR21700SD-2S1P
	<b>Serial No.:</b>	N/A
	<b>Capacity:</b>	4650mAh
	<b>Rated Voltage:</b>	7.2V
	<b>Charge Limit:</b>	8.4V
	<b>Manufacturer:</b>	Guangdong Pow-Tech New Power Co., Ltd.



<b>Accessory Information:</b>	AC Adapter	
	Brand Name:	N/A
	Model No.:	NSA45EU-20022500
	Serial No.:	N/A
	Rated Output:	5V=3A, 9V=3A, 12V=3A, 15V=3A, 20V=2.25A
	Rated Input:	100-240V~50/60Hz, 1.2A
	Manufacturer:	Shenzhen JingQuanHua & Everrise Intelligent Electric Co., Ltd.

**Note 1:** The EUT supports a MIMO function. Physically, the EUT provides two completed transmitters and two receivers for 802.11n, 802.11ac and 802.11ax modulation mode.

<b>Modulation Mode:</b>	<b>TX Function</b>
802.11a	1TX
802.11n	2TX
802.11ac	2TX

**Note 2:** According to KDB 662911 D01, the directional gain =  $10\log[(10^{G0/20}+10^{G1/20})^2/2] = 8.19\text{dBi}$ .

**Note 3:** All radiation test items for 802.11n, 802.11ac and 802.11ax modulation mode operate at MIMO mode during the test. Other modulation mode operate at SISO mode, both of the two antennas were tested separately, we only recorded the worst test result(ANT1) in this report.

**Note 4:** We use the dedicated software to control the EUT continuous transmission.

**Note 5:** For a more detailed description, please refer to Specification or User's Manual supplied by the applicant and/or manufacturer.

## 2.3. Channel List of EUT

<b>(U-NII-1) 5180MHz-5240MHz</b>				
Bandwidth	Channel	Frequency (MHz)	Channel	Frequency (MHz)
20MHz	<b>36</b>	<b>5180</b>	40	5200
	<b>44</b>	<b>5220</b>	<b>48</b>	<b>5240</b>
40MHz	<b>38</b>	<b>5190</b>	<b>46</b>	<b>5230</b>
80MHz	<b>42</b>	<b>5210</b>		
<b>(U-NII-2A) 5260MHz-5320MHz</b>				
Bandwidth	Channel	Frequency (MHz)	Channel	Frequency (MHz)
20MHz	<b>52</b>	<b>5260</b>	56	5280
	<b>60</b>	<b>5300</b>	<b>64</b>	<b>5320</b>
40MHz	<b>54</b>	<b>5270</b>	<b>62</b>	<b>5310</b>
80MHz	<b>58</b>	<b>5290</b>		
<b>(U-NII-2C) 5500MHz-5720MHz</b>				
Bandwidth	Channel	Frequency (MHz)	Channel	Frequency (MHz)
20MHz	<b>100</b>	<b>5500</b>	105	5520
			108	5540
			116	5580
			<b>120</b>	<b>5600</b>
			124	5620
			132	5660
40MHz	<b>140</b>	<b>5700</b>	<b>144</b>	<b>5720</b>
	<b>102</b>	<b>5510</b>	110	5550
	118	5590	<b>126</b>	<b>5630</b>
80MHz	134	5670	<b>142</b>	<b>5710</b>
	<b>106</b>	<b>5530</b>	<b>122</b>	<b>5610</b>
	<b>138</b>	<b>5690</b>		
<b>(U-NII-3) 5745MHz-5825MHz</b>				
Bandwidth	Channel	Frequency (MHz)	Channel	Frequency (MHz)
20MHz	<b>149</b>	<b>5745</b>	153	5765
	<b>157</b>	<b>5785</b>	161	5805
	<b>165</b>	<b>5825</b>		
40MHz	<b>151</b>	<b>5775</b>	<b>159</b>	<b>5795</b>
80MHz	<b>155</b>	<b>5775</b>		

**Note 1:** The black bold channels were selected for test.

## 2.4. Test Configuration of EUT

### 2.4.1. Modulation Type and Data Rate of EUT

Mode	Bandwidth (MHz)	Modulation Technology	Modulation Type	Data Rate	RU Size
802.11a	20	OFDM	<b>BPSK</b>	6/9/12/18/24/36/48/54 Mbps	N/A
			QPSK		
			16QAM		
			64QAM		
802.11n	20/40 (HT20/40)	OFDM	<b>BPSK</b>	<b>MCS0~MCS7</b>	N/A
			QPSK		
			16QAM		
			64QAM		
802.11ac	20/40/80 (VHT20/40/80)	OFDM	<b>BPSK</b>	<b>MCS0~MCS9</b>	N/A
			QPSK		
			16QAM		
			64QAM		
			256QAM		

**Note1:** The worst-case mode (bold face) in all data rates has been determined during the pre-scan, only the test data of the worst-case were recorded in this report.

## 2.5. Test Conditions

Temperature (°C)	15-35
Relative Humidity (%)	30-60
Atmospheric Pressure (kPa)	86-106

## 2.6. Test Setup Layout Diagram

### 2.6.1. Conducted Measurement

For power item that BW below 80MHz system:



For power item that BW equal or above 80MHz and other items:

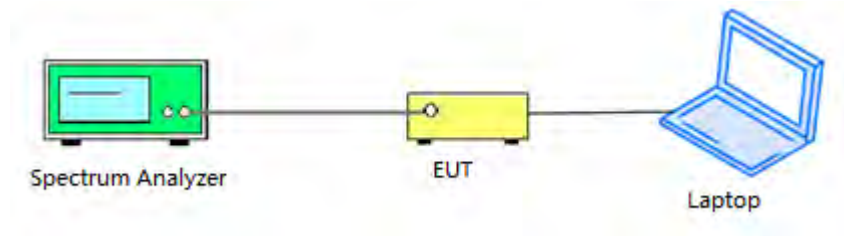

### 2.6.2. Conducted Emission Measurement



**2.6.3.Radiation Measurement**

1) For radiated emissions from 9kHz to 30MHz

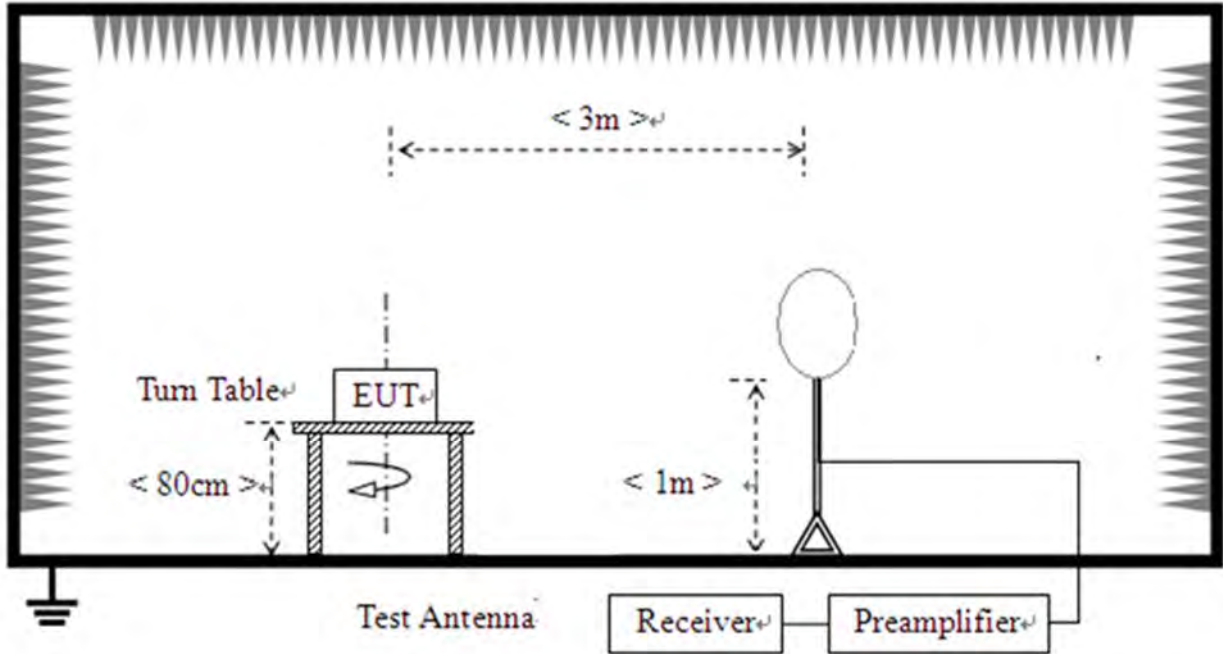

2) For radiated emissions from 30MHz to 1GHz

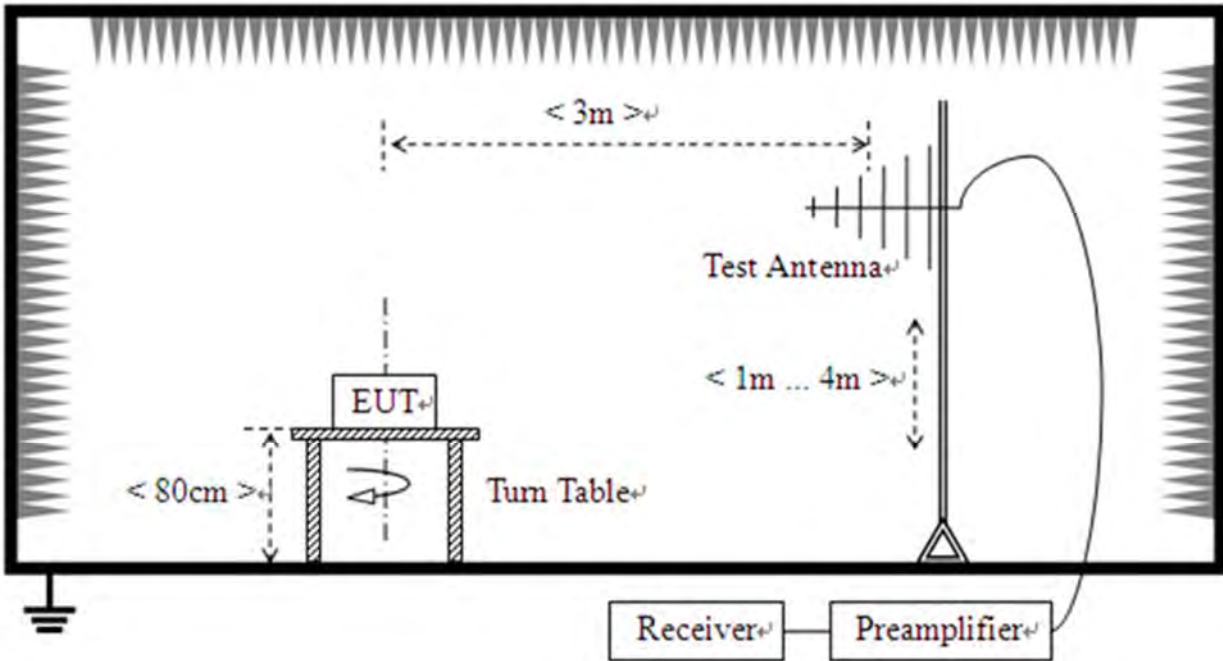

3) For radiated emissions above 1GHz

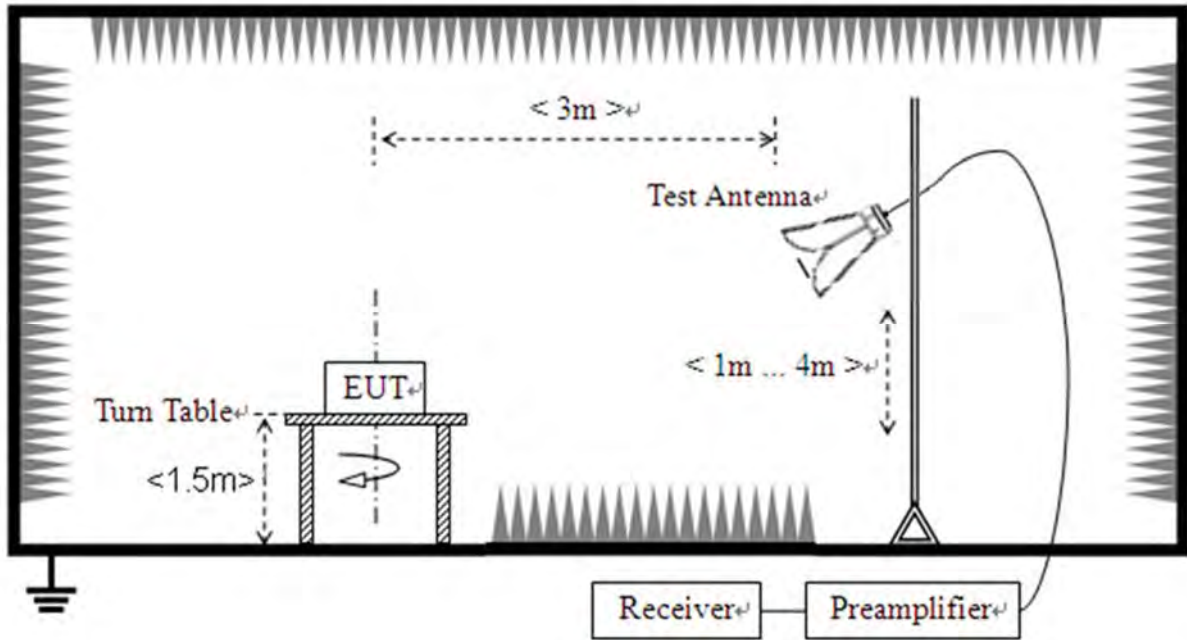



## 3. Test Results

### 3.1. Antenna Requirement

#### 3.1.1. Requirement

According to FCC 15.203, an intentional radiator shall be designed to ensure that no antenna other than that furnished by the responsible party shall be used with the device. The use of a permanently attached antenna or of an antenna that uses a unique coupling to the intentional radiator shall be considered sufficient to comply with the provisions of this section.

#### 3.1.2. Test Result

The EUT has a permanently and irreplaceable attached antenna. Please refer to the EUT internal photos.





## 3.2. Duty Cycle of Test Signal

### 3.2.1. Requirement

Preferably, all measurements of maximum conducted (average) output power will be performed with the EUT transmitting continuously (i.e., with a duty cycle of greater than or equal to 98%). When continuous operation cannot be realized, then the use of sweep triggering/signal gating techniques can be used to ensure that measurements are made only during transmissions at the maximum power control level. Such sweep triggering/signal gating techniques will require knowledge of the minimum transmission duration ( $T$ ) over which the transmitter is on and is transmitting at its maximum power control level for the tested mode of operation. Sweep triggering/signal gating techniques can then be used if the measurement/sweep time of the analyzer can be set such that it does not exceed  $T$  at any time that data are being acquired (i.e., no transmitter OFF-time is to be considered).

When continuous transmission cannot be achieved and sweep triggering/signal gating cannot be implemented, alternative procedures are provided that can be used to measure the average power; however, they will require an additional measurement of the transmitter duty cycle ( $D$ ). Within this sub clause, the duty cycle refers to the fraction of time over which the transmitter is ON and is transmitting at its maximum power control level. The duty cycle is considered to be constant if variations are less than  $\pm 2\%$ ; otherwise, the duty cycle is considered to be non constant.

### 3.2.2. Test Result

Refer to Annex A.1 in this report.



### 3.3. Maximum Conducted Output Power

#### 3.3.1. Requirement

(1) For client devices in the 5.15-5.25 GHz band, the maximum conducted output power over the frequency band of operation shall not exceed 250mW provided the maximum antenna gain does not exceed 6dBi.

(2) For the 5.25-5.35 GHz and 5.47-5.725 GHz bands, the maximum conducted output power over the frequency bands of operation shall not exceed the lesser of 250mW or  $11\text{dBm} + 10 \log B$ , where B is the 26 dB emission bandwidth in megahertz.

(3) For the band 5.725-5.85 GHz, the maximum conducted output power over the frequency band of operation shall not exceed 1 W.

If transmitting antennas of directional gain greater than 6dBi are used, the maximum conducted output power shall be reduced by the amount in dB that the directional gain of the antenna exceeds 6dBi.

(4) According to KDB662911D01 Measure-and-sum technique, the conducted emission level (e.g., transmit power or power in specified bandwidth) is measured at each antenna port. The measured results at the various antenna ports are then summed mathematically to determine the total emission level from the device. Summing is performed in units that are directly proportional to power.

(5) According to KDB 662911 D01, the directional gain =  $G_{\text{ANT}} + 10\log(N_{\text{ANT}})\text{dBi}$ , where  $G_{\text{ANT}}$  is the antenna gain in dBi,  $N_{\text{ANT}}$  is the number of outputs.

#### 3.3.2. Test Procedures

The EUT (Equipment under the test) which is coupled to the USB Wideband Power Sensor; the RF load attached to the EUT antenna terminal is 50Ohm; the path loss as the factor is calibrated to correct the reading, all test result in USB Wideband Power Sensor.

##### **For ac (VHT80) mode power**

The EUT (Equipment under the test) is coupled to the Spectrum analyzer; the RF load attached to the EUT antenna terminal is 50Ohm; the path loss as the factor is calibrated to correct the reading, all test result in Spectrum analyzer.



REPORT No.: SZ24030326W04

### **3.3.3. Test Setup Layout**

Refer to chapter 2.6.1 in this report.

### **3.3.4. Test Result**

Refer to Annex A.2 in this report.



## 3.4. Emission Bandwidth

### 3.4.1. Requirement

For purposes of this subpart the emission bandwidth shall be determined by measuring the width of the signal between two points, one below the carrier center frequency and one above the carrier center frequency, that are 26 dB down relative to the maximum level of the modulated carrier. Determination of the emissions bandwidth is based on the use of measurement instrumentation employing a peak detector function with an instrument resolution bandwidth approximately equal to 1.0 percent of the emission bandwidth of the device under measurement. Within the 5.725-5.85 GHz band, the minimum 6 dB bandwidth of U-NII devices shall be at least 500 kHz.

### 3.4.1. Test Procedures

1. KDB 789033 Section C) 1) Emission Bandwidth was used in order to prove compliance

- a) Set RBW = approximately 1% of the emission bandwidth.
- b) Set VBW > RBW.
- c) Detector = Peak.
- d) Trace mode = max hold.
- e) Measure the maximum width of the emission that is 26 dB down from the peak of the emission. Compare this with the RBW setting of the analyzer. Readjust RBW and repeat measurement as needed until the RBW/EBW ratio is approximately 1%.

2. KDB 789033 Section C) 2) minimum emission bandwidth for the band 5.725-5.85GHz was used in order to prove compliance.

Section 15.407(e) specifies the minimum 6 dB emission bandwidth of at least 500 KHz for theband5.715-5.85 GHz. The following procedure shall be used for measuring this bandwidth:

- a) Set RBW = 100 kHz.
- b) Set video bandwidth (VBW)  $\geq 3 \times$  RBW.
- c) Detector = Peak.
- d) Trace mode = max hold.
- e) Sweep = auto couple.
- f) Allow the trace to stabilize.
- g) Measure the maximum width of the emission that is constrained by the frequencies associated with the two outermost amplitude points (upper and lower frequencies) that are attenuated by 6 dB relative to the maximum level measured in the fundamental emission.



REPORT No.: SZ24030326W04

### **3.4.2. Test Setup Layout**

Refer to chapter 2.6.1 in this report.

### **3.4.3. Test Result**

Refer to Annex A.3 in this report.



## 3.5. Peak Power Spectral Density

### 3.5.1. Requirement

(1) For client devices in the 5.15-5.25 GHz band, the maximum power spectral density shall not exceed 11dBm in any 1 megahertz band.

(2) For the 5.25-5.35 GHz and 5.47-5.725 GHz bands, the maximum power spectral density shall not exceed 11dBm in any 1 megahertz band.

(3) For the band 5.725-5.85 GHz, the maximum power spectral density shall not exceed 30dBm in any 500kHz band.

If transmitting antennas of directional gain greater than 6dBi are used, the maximum power spectral density shall be reduced by the amount in dB that the directional gain of the antenna exceeds 6dBi.

(4) According to KDB662911D01 Measure-and-sum technique, the conducted emission level (e.g., transmit power or power in specified bandwidth) is measured at each antenna port. The measured results at the various antenna ports are then summed mathematically to determine the total emission level from the device. Summing is performed in units that are directly proportional to power.

(5) According to KDB 662911 D01, the directional gain =  $G_{ANT} + 10\log(N_{ANT})$  dBi, where  $G_{ANT}$  is the antenna gain in dBi,  $N_{ANT}$  is the number of outputs.

### 3.5.2. Test Procedures

KDB 789033 Section F) Maximum Power Spectral Density (PSD) Method SA-3 was used in order to prove compliance

- 1) Set span to encompass the entire 26-dB emission bandwidth
  - 2) Set RBW = 1MHz. Set VBW  $\geq$  3MHz
  - 3) Number of points in sweep  $\geq$  2 Span / RBW. Sweep time = auto
  - 4) Detector = Average
  - 5) Trace mode=Max hold
- Record the max value

### 3.5.3. Test Setup Layout

Refer to chapter 2.6.1 in this report.

### 3.5.4. Test Result

Refer to Annex A.4 in this report.



## 3.6. Frequency Stability

### 3.6.1. Requirement

Manufacturers of U-NII devices are responsible for ensuring frequency stability such that an emission is maintained within the band of operation under all conditions of normal operation as specified in the user's manual.

### 3.6.2. Test Procedures

The EUT was placed inside of an environmental chamber as the temperature in the chamber was varied between 5°C to 40°C. The temperature was incremented by 10° intervals and the unit was allowed to stabilize at each temperature before each measurement. The center frequency of the transmitting channel was evaluated at each temperature and the frequency deviation from the channel's center frequency was recorded. Data for the worst case channel is shown below.

### 3.6.3. Test Result

Refer to Annex A.5 in this report.



### 3.7. Dynamic Frequency Selection

#### 3.7.1. Requirement

According to FCC section 15.407(h), (1) Transmit power control (TPC). U-NII devices operating in the 5.25-5.35 GHz band and the 5.47-5.725 GHz band shall employ a TPC mechanism. The U-NII device is required to have the capability to operate at least 6 dB below the mean EIRP value of 30 dBm. A TPC mechanism is not required for systems with an e.i.r.p. of less than 500 mW. (2) Radar Detection Function of Dynamic Frequency Selection (DFS). U-NII devices operating with any part of its 26 dB emission bandwidth in the 5.25-5.35 GHz and 5.47-5.725 GHz bands shall employ a DFS radar detection mechanism to detect the presence of radar systems and to avoid co-channel operation with radar systems. Operators shall only use equipment with a DFS mechanism that is turned on when operating in these bands. The device must sense for radar signals at 100 percent of its emission bandwidth. The minimum DFS detection threshold for devices with a maximum e.i.r.p. of 200 mW to 1 W is -64 dBm. For devices that operate with less than 200 mW e.i.r.p. and a power spectral density of less than 10 dBm in a 1 MHz band, the minimum detection threshold is -62 dBm. The detection threshold is the received power averaged over 1 microsecond referenced to a 0 dBi antenna. For the initial channel setting, the manufacturers shall be permitted to provide for either random channel selection or manual channel selection.

A U-NII network will employ a DFS function to detect signals from radar systems and to avoid co-channel operation with these systems. This applies to the 5250-5350 MHz and/or 5470-5725 MHz bands.<sup>1</sup>

Within the context of the operation of the DFS function, a U-NII device will operate in either Master Mode or Client Mode. U-NII devices operating in Client Mode can only operate in a network controlled by a U-NII device operating in Master Mode.<sup>2</sup>

Tables 1 and 2 shown below summarize the information contained in sections 5.1.1 and 5.1.2.

**Table 1: Applicability of DFS Requirements Prior to Use of a Channel**

Requirement	Operational Mode		
	Master	Client Without Radar Detection	Client With Radar Detection
Non-Occupancy Period	Yes	Not required	Yes
DFS Detection Threshold	Yes	Not required	Yes
Channel Availability Check Time	Yes	Not required	Not required
U-NII Detection Bandwidth	Yes	Not required	Yes

**Table 2: Applicability of DFS requirements during normal operation**

Requirement	Operational Mode
-------------	------------------





	Master	Client Without Radar Detection
DFS Detection Threshold	Yes	Not required
Channel Closing Transmission Time	Yes	Yes
Channel Move Time	Yes	Yes
U-NII Detection Bandwidth	Yes	Not required

Additional requirements for devices with multiple bandwidth modes	Master Device or Client with Radar Detection	Client Without Radar Detection
U-NII Detection Bandwidth and Statistical Performance Check	All BW modes must be tested	Not required
Channel Move Time and Channel Closing Transmission Time	Test using widest BW mode available	Test using the widest BW mode available for the link
All other tests	Any single BW mode	Not required

Note: Frequencies selected for statistical performance check (Section 7.8.4) should include several frequencies within the radar detection bandwidth and frequencies near the edge of the radar detection bandwidth. For 802.11 devices it is suggested to select frequencies in each of the bonded 20 MHz channels and the channel center frequency.

The operational behavior and individual DFS requirements that are associated with these modes are as follows:

**Master Devices**

- a) The Master Device will use DFS in order to detect Radar Waveforms with received signal strength above the DFS Detection Threshold in the 5250 – 5350 MHz and 5470 – 5725 MHz bands. DFS is not required in the 5150 – 5250 MHz or 5725 – 5825 MHz bands.
- b) Before initiating a network on a Channel, the Master Device will perform a Channel Availability Check for specified time duration (Channel Availability Check Time) to ensure that there is no radar system operating on the Channel, using DFS described under subsection a) above.
- c) The Master Device initiates a U-NII network by transmitting control signals that will enable other U-NII devices to Associate with the Master Device.
- d) During normal operation, the Master Device will monitor the Channel (In-Service Monitoring) to ensure that there is no radar system operating on the Channel, using DFS described under a).
- e) If the Master Device has detected a Radar Waveform during In-Service Monitoring as described under d), the Operating Channel of the U-NII network is no longer an Available Channel. The Master Device will instruct all associated Client Device(s) to stop transmitting on this Channel within the Channel Move Time. The transmissions during the Channel Move Time will be limited to the Channel Closing Transmission Time.
- f) Once the Master Device has detected a Radar Waveform it will not utilize the Channel for the duration of the Non-Occupancy Period. 3.



g) If the Master Device delegates the In-Service Monitoring to a Client Device, then the combination will be tested to the requirements described under d) through f) above.

**Client Devices**

a) A Client Device will not transmit before having received appropriate control signals from a Master Device.

b) A Client Device will stop all its transmissions whenever instructed by a Master Device to which it is associated and will meet the Channel Move Time and Channel Closing Transmission Time requirements. The Client Device will not resume any transmissions until it has again received control signals from a Master Device.

c) If a Client Device is performing In-Service Monitoring and detects a Radar Waveform above the DFS Detection Threshold, it will inform the Master Device. This is equivalent to the Master Device detecting the Radar Waveform and d) through f) of section 5.1.1 apply.

d) Irrespective of Client Device or Master Device detection the Channel Move Time and Channel Closing Transmission Time requirements remain the same.

e) The client test frequency must be monitored to ensure no transmission of any type has occurred for 30 minutes. Note: If the client moves with the master, the device is considered compliant if nothing appears in the client non-occupancy period test. For devices that shut down (rather than moving channels), no beacons should appear.

**DFS Detection Thresholds**

Table 3 below provides the DFS Detection Thresholds for Master Devices as well as Client Devices incorporating In-Service Monitoring.

**Table 3: DFS Detection Thresholds for Master Devices and Client Devices with Radar Detection**

Maximum Transmit Power	Value (See Notes 1, 2, and 3)
EIRP $\geq$ 200 mill watt	-64 dBm
EIRP < 200 mill watt and power spectral density < 10 dBm/MHz	-62 dBm
EIRP < 200 mill watt that do not meet the power spectral density requirement	-64 dBm

Note 1: This is the level at the input of the receiver assuming a 0 dBi receive antenna.  
 Note 2: Throughout these test procedures an additional 1 dB has been added to the amplitude of the test transmission waveforms to account for variations in measurement equipment. This will ensure that the test signal is at or above the detection threshold level to trigger a DFS response.  
 Note3: EIRP is based on the highest antenna gain. For MIMO devices refer to KDB Publication 662911 D01.

**Response Requirements**

Table 4 provides the response requirements for Master and Client Devices incorporating DFS.

**Table 4: DFS Response Requirement Values**

Parameter	Value
Non-occupancy period	Minimum 30 minutes
Channel Availability Check Time	60 seconds
Channel Move Time	10 seconds See Note 1.
Channel Closing Transmission Time	200 milliseconds + an aggregate of 60 milliseconds over remaining 10 second period. See Notes 1 and 2.
U-NII Detection Bandwidth	Minimum 100% of the U-NII 99% transmission power bandwidth. See Note 3.

**Note 1:** Channel Move Time and the Channel Closing Transmission Time should be performed with Radar Type 0. The measurement timing begins at the end of the Radar Type 0 burst.

**Note 2:** The Channel Closing Transmission Time is comprised of 200 milliseconds starting at the beginning of the Channel Move Time plus any additional intermittent control signals required to facilitate a Channel move (an aggregate of 60 milliseconds) during the remainder of the 10 second period. The aggregate duration of control signals will not count quiet periods in between transmissions.

**Note 3:** During the U-NII Detection Bandwidth detection test, radar type 0 should be used. For each frequency step the minimum percentage of detection is 90 percent. Measurements are performed with no data traffic.

### 3.7.2. Test Description

According to Section 7.2 of KDB 905462 D02 V01R01

#### 1. Setup for Master with injection at the Master

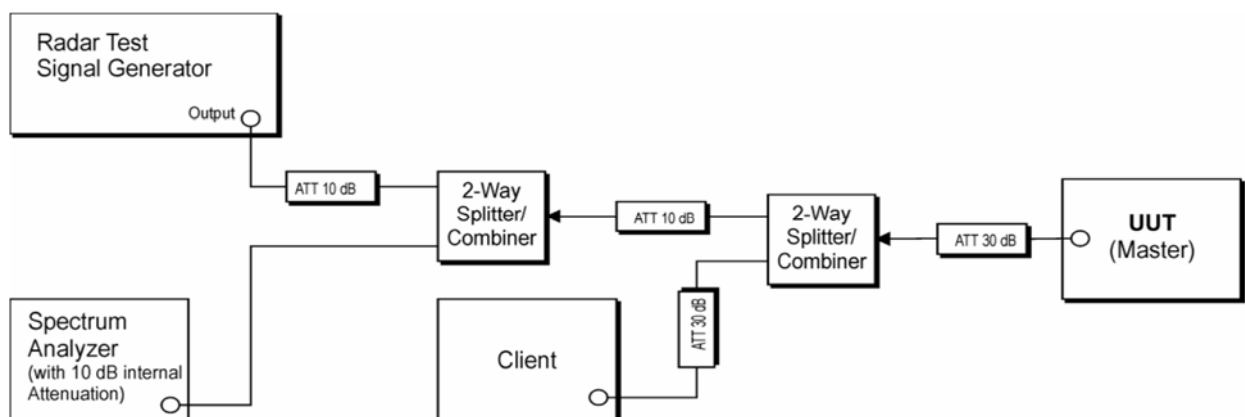

(Example Conducted Setup where UUT is a Master and Radar Test Waveforms are injected into the Master)

#### 2. Setup for Client with injection at the Master

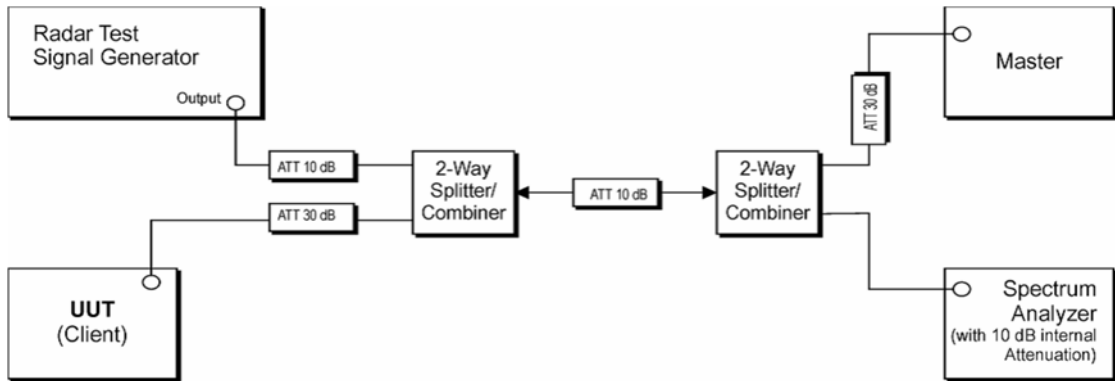

(Example Conducted Setup where UUT is a Client and Radar Test Waveforms are injected into the Master)

3. Setup for Client with injection at the Client

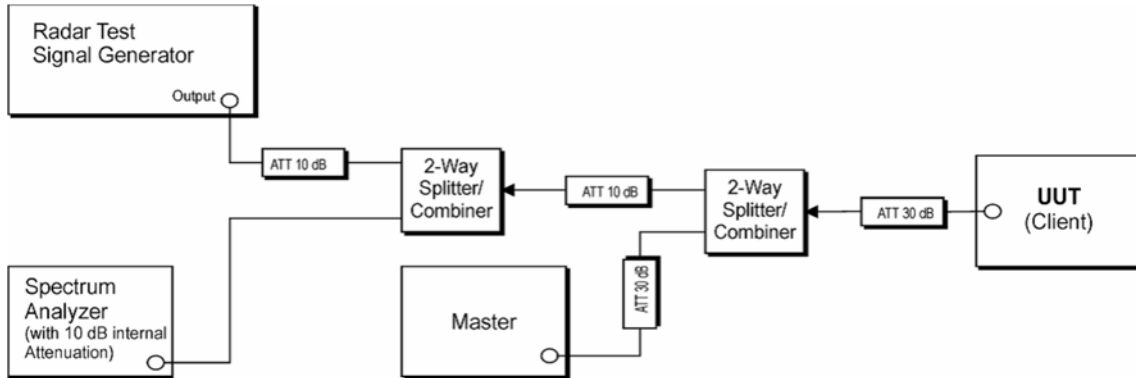

(Example Conducted Setup where UUT is a Client and Radar Test Waveforms are injected into the Client)

3.7.3. Information of Companion Device

Product Name:	Router
Manufacturer:	ASUS
FCC ID:	MSQ-RTAXJF00
Device Type:	Master Device
Operating Mode:	Master Mode
Serial No:	M3IAJF201046
Antenna Gain:	2.0dBi

3.7.4. Test Result

Refer to Annex A.6 in this report.



### 3.8. Conducted Emission

#### 3.8.1. Requirement

According to FCC section 15.207, for an intentional radiator that is designed to be connected to the public utility (AC) power line, the radio frequency voltage that is conducted back onto the AC power line on any frequency within the band 150kHz to 30MHz shall not exceed the limits in the following table, as measured using a 50μH/50Ω line impedance stabilization network (LISN).

Frequency Range (MHz)	Conducted Limit (dBμV)	
	Quai-peak	Average
0.15 - 0.50	66 to 56	56 to 46
0.50 - 5	56	46
5 - 30	60	50

Note:

- (a) The lower limit shall apply at the band edges.
- (b) The limit decreases linearly with the logarithm of the frequency in the range 0.15 - 0.50MHz.

#### 3.8.2. Test Procedures

The Table-top EUT was placed upon a non-metallic table 0.8m above the horizontal metal reference ground plane. EUT was connected to LISN and LISN was connected to reference Ground Plane. EUT was 80cm from LISN. The set-up and test methods were according to ANSI C63.10: 2013.

#### 3.8.3. Test Setup Layout

Refer to chapter 2.6.2 in this report.

#### 3.8.4. Test Result

Refer to Annex A.7 in this report.



### 3.9. Restricted Frequency Bands

#### 3.9.1. Requirement

The peak emissions outside of the frequency bands of operation shall be attenuated in accordance with the following limits:

- (1) For transmitters operating in the 5.15–5.25 GHz band: all emissions outside of the 5.15–5.35 GHz band shall not exceed an EIRP of -27dBm/MHz.
- (2) For transmitters operating in the 5.25–5.35 GHz band: all emissions outside of the 5.15–5.35 GHz band shall not exceed an EIRP of -27dBm/MHz.
- (3) For transmitters operating in the 5.47–5.725 GHz band: all emissions outside of the 5.47–5.725 GHz band shall not exceed an EIRP of -27dBm/MHz.
- (4) For transmitters operating in the 5.725-5.85 GHz band:
  - (i) All emissions shall be limited to a level of -27 dBm/MHz at 75 MHz or more above or below the band edge increasing linearly to 10 dBm/MHz at 25 MHz above or below the band edge, and from 25 MHz above or below the band edge increasing linearly to a level of 15.6 dBm/MHz at 5 MHz above or below the band edge, and from 5 MHz above or below the band edge increasing linearly to a level of 27 dBm/MHz at the band edge.

The following formula is used to convert the equipment isotropic radiated power(e.i.r.p.) to field strength (dBμV/m);

$$E = 1000000 \times \sqrt{30P} / 3 \mu\text{V/m}$$

where P is the EIRP in Watts

Therefore: -27 dBm/MHz = 68.23 dBuV/m



Unwanted emissions below 1 GHz must comply with the general field strength limits set forth in § 15.209. According to FCC section 15.209 (a), except as provided elsewhere in this subpart, the emissions from an intentional radiator shall not exceed the field strength levels specified in the following table:

Frequency (MHz)	Field Strength ( $\mu\text{V}/\text{m}$ )	Measurement Distance (m)
0.009 - 0.490	2400/F(kHz)	300
0.490 - 1.705	24000/F(kHz)	30
1.705 - 30.0	30	30
30 - 88	100	3
88 - 216	150	3
216 - 960	200	3
Above 960	500	3

For Above 1000MHz, the emission limit in this paragraph is based on measurement instrumentation employing an average detector, measurement using instrumentation with a peak detector function, corresponding to 20dB above the maximum permitted average limit. In addition, radiated emissions which fall in the restricted bands, as defined in Section 15.205(a), also should comply with the radiated emission limits specified in Section 15.209(a)(above table).

### 3.9.2. Test Procedures

The EUT is located in a 3m Semi-Anechoic Chamber; the antenna factors, cable loss and so on of the site as factors are calculated to correct the reading.

KDB 789033 Section H) 3)5)6(d)) was used in order to prove compliance

For the Test Antenna:

Test Antenna is 3m away from the EUT. Test Antenna height is varied from 1m to 4m above the ground to determine the maximum value of the field strength.

### 3.9.3. Test Setup Layout

Refer to chapter 2.6.3 in this report.

### 3.9.4. Test Result

Refer to Annex A.8 in this report.

### 3.10. Radiated Emission

#### 3.10.1.Requirement

The peak emissions outside of the frequency bands of operation shall be attenuated in accordance with the following limits:

- (1) For transmitters operating in the 5.15–5.25 GHz band: all emissions outside of the 5.15–5.35 GHz band shall not exceed an EIRP of -27dBm/MHz.
- (2) For transmitters operating in the 5.25–5.35 GHz band: all emissions outside of the 5.15–5.35 GHz band shall not exceed an EIRP of -27dBm/MHz.
- (3) For transmitters operating in the 5.47–5.725 GHz band: all emissions outside of the 5.47–5.725 GHz band shall not exceed an EIRP of -27dBm/MHz.
- (4) For transmitters operating in the 5.725-5.85 GHz band: All emissions within the frequency range from the band edge to 10 MHz above or below the band edge shall not exceed an e.i.r.p. of -17 dBm/MHz; for frequencies 10 MHz or greater above or below the band edge, emissions shall not exceed an e.i.r.p. of -27 dBm/MHz.

The following formula is used to convert the equipment isotropic radiated power(e.i.r.p.) to field strength (dBμV/m);

$$E = 1000000 \times \sqrt{\frac{30P}{3}} \mu\text{V/m}$$

where P is the EIRP in Watts

Therefore: -27 dBm/MHz = 68.23 dBuV/m

Unwanted emissions below 1 GHz must comply with the general field strength limits set forth in § 15.209. According to FCC section 15.209 (a), except as provided elsewhere in this subpart, the emissions from an intentional radiator shall not exceed the field strength levels specified in the following table:

Frequency (MHz)	Field Strength (μV/m)	Measurement Distance (m)
0.009 - 0.490	2400/F(kHz)	300
0.490 - 1.705	24000/F(kHz)	30
1.705 - 30.0	30	30
30 - 88	100	3
88 - 216	150	3
216 - 960	200	3
Above 960	500	3





For Above 1000MHz, the emission limit in this paragraph is based on measurement instrumentation employing an average detector, measurement using instrumentation with a peak detector function, corresponding to 20dB above the maximum permitted average limit. In addition, radiated emissions which fall in the restricted bands, as defined in Section 15.205(a), also should comply with the radiated emission limits specified in Section 15.209(a)(above table).

### **3.10.2.Test Procedures**

The EUT is placed on a non-conducting table 80 cm above the ground plane for measurement below 1GHz; 1.5 m above the ground plane for measurement above 1GHz.The antenna to EUT distance is 3meters. The EUT is configured in accordance with ANSI C63.10. The EUT is set to transmit in a continuous mode.

For measurements below 30MHz, the emission limits shown in the above table are based on measurements employing a CISPR quasi-peak detector except for the frequency bands 9kHz-90 kHz, 110kHz-490 kHz. Radiated emission limits in these two bands are based on measurements employing an average detector.

For measurements below 1GHz the resolution bandwidth is set to 100kHz for peak detection measurements or 120kHz for quasi-peak detection measurements. Peak detection is used unless otherwise noted as quasi-peak.

For measurements above 1GHz the resolution bandwidth is set to 1MHz, the video band width is set to 3MHz for peak measurements and as applicable for average measurements.

The EUT is rotated through 360 degrees to maximize emissions received. The antenna is scanned from 1 to 4 meters above the ground plane to further maximize the emission. Measurements are made with the antenna polarized in both the vertical and the horizontal positions. For measurements above 1 GHz, keeping the measurement antenna aimed at the source of emissions at each frequency of significant emissions, with polarization oriented for maximum response.

### **3.10.3.Test Setup Layout**

Refer to chapter 2.6.3 in this report.

### **3.10.4.Test Result**

Refer to Annex A.9 in this report.



## Annex A Test Data and Result

### A.1. Duty Cycle of Test Signal

Condition	Mode	Frequency (MHz)	Antenna	Duty Cycle (%)	Correction Factor (dB)	1/T (kHz)
NVNT	a SISO	5180	Ant1	95.86	0.18	0.72
NVNT	a SISO	5220	Ant1	96.53	0.15	0.72
NVNT	a SISO	5240	Ant1	96.55	0.15	0.71
NVNT	a SISO	5260	Ant1	95.86	0.18	0.72
NVNT	a SISO	5300	Ant1	96.53	0.15	0.72
NVNT	a SISO	5320	Ant1	96.53	0.15	0.72
NVNT	a SISO	5500	Ant1	95.86	0.18	0.72
NVNT	a SISO	5580	Ant1	95.86	0.18	0.72
NVNT	a SISO	5600	Ant1	95.86	0.18	0.72
NVNT	a SISO	5720	Ant1	96.53	0.15	0.72
NVNT	a SISO	5745	Ant1	96.55	0.15	0.71
NVNT	a SISO	5785	Ant1	96.53	0.15	0.72
NVNT	a SISO	5825	Ant1	96.55	0.15	0.71
NVNT	a SISO	5180	Ant2	95.86	0.18	0.72
NVNT	a SISO	5220	Ant2	96.53	0.15	0.72
NVNT	a SISO	5240	Ant2	95.86	0.18	0.72
NVNT	a SISO	5260	Ant2	96.53	0.15	0.72
NVNT	a SISO	5300	Ant2	95.86	0.18	0.72
NVNT	a SISO	5320	Ant2	96.53	0.15	0.72
NVNT	a SISO	5500	Ant2	95.86	0.18	0.72
NVNT	a SISO	5580	Ant2	96.53	0.15	0.72
NVNT	a SISO	5600	Ant2	96.53	0.15	0.72
NVNT	a SISO	5720	Ant2	96.3	0.16	0.77
NVNT	a SISO	5745	Ant2	95.59	0.2	0.77
NVNT	a SISO	5785	Ant2	96.3	0.16	0.77
NVNT	a SISO	5825	Ant2	96.55	0.15	0.71
NVNT	n20 SISO	5180	Ant1	96.3	0.16	0.77
NVNT	n20 SISO	5220	Ant1	96.3	0.16	0.77
NVNT	n20 SISO	5240	Ant1	96.3	0.16	0.77
NVNT	n20 SISO	5260	Ant1	96.3	0.16	0.77
NVNT	n20 SISO	5300	Ant1	95.59	0.2	0.77
NVNT	n20 SISO	5320	Ant1	96.3	0.16	0.77



NVNT	n20 SISO	5500	Ant1	96.3	0.16	0.77
NVNT	n20 SISO	5580	Ant1	96.3	0.16	0.77
NVNT	n20 SISO	5600	Ant1	96.3	0.16	0.77
NVNT	n20 SISO	5720	Ant1	95.59	0.2	0.77
NVNT	n20 SISO	5745	Ant1	95.59	0.2	0.77
NVNT	n20 SISO	5785	Ant1	96.3	0.16	0.77
NVNT	n20 SISO	5825	Ant1	96.3	0.16	0.77
NVNT	n20 SISO	5180	Ant2	95.59	0.2	0.77
NVNT	n20 SISO	5220	Ant2	95.59	0.2	0.77
NVNT	n20 SISO	5240	Ant2	96.3	0.16	0.77
NVNT	n20 SISO	5260	Ant2	96.3	0.16	0.77
NVNT	n20 SISO	5300	Ant2	96.3	0.16	0.77
NVNT	n20 SISO	5320	Ant2	96.3	0.16	0.77
NVNT	n20 SISO	5500	Ant2	96.3	0.16	0.77
NVNT	n20 SISO	5580	Ant2	96.3	0.16	0.77
NVNT	n20 SISO	5600	Ant2	96.3	0.16	0.77
NVNT	n20 SISO	5720	Ant2	96.3	0.16	0.77
NVNT	n20 SISO	5745	Ant2	96.3	0.16	0.77
NVNT	n20 SISO	5785	Ant2	96.3	0.16	0.77
NVNT	n20 SISO	5825	Ant2	96.3	0.16	0.77
NVNT	n20 MIMO	5180	Sum	95.59	0.2	0.77
NVNT	n20 MIMO	5220	Sum	95.59	0.2	0.77
NVNT	n20 MIMO	5240	Sum	96.3	0.16	0.77
NVNT	n20 MIMO	5260	Sum	95.59	0.2	0.77
NVNT	n20 MIMO	5300	Sum	96.3	0.16	0.77
NVNT	n20 MIMO	5320	Sum	96.3	0.16	0.77
NVNT	n20 MIMO	5500	Sum	96.3	0.16	0.77
NVNT	n20 MIMO	5580	Sum	96.3	0.16	0.77
NVNT	n20 MIMO	5600	Sum	96.3	0.16	0.77
NVNT	n20 MIMO	5720	Sum	96.3	0.16	0.77
NVNT	n20 MIMO	5745	Sum	96.3	0.16	0.77
NVNT	n20 MIMO	5785	Sum	95.59	0.2	0.77
NVNT	n20 MIMO	5825	Sum	96.3	0.16	0.77
NVNT	n40 SISO	5190	Ant1	91.43	0.39	1.56
NVNT	n40 SISO	5230	Ant1	92.86	0.32	1.54
NVNT	n40 SISO	5270	Ant1	92.86	0.32	1.54
NVNT	n40 SISO	5310	Ant1	92.86	0.32	1.54
NVNT	n40 SISO	5510	Ant1	91.43	0.39	1.56



NVNT	n40 SISO	5550	Ant1	92.86	0.32	1.54
NVNT	n40 SISO	5630	Ant1	91.43	0.39	1.56
NVNT	n40 SISO	5710	Ant1	92.86	0.32	1.54
NVNT	n40 SISO	5755	Ant1	92.86	0.32	1.54
NVNT	n40 SISO	5795	Ant1	92.86	0.32	1.54
NVNT	n40 SISO	5190	Ant2	91.55	0.38	1.54
NVNT	n40 SISO	5230	Ant2	92.86	0.32	1.54
NVNT	n40 SISO	5270	Ant2	92.86	0.32	1.54
NVNT	n40 SISO	5310	Ant2	91.43	0.39	1.56
NVNT	n40 SISO	5510	Ant2	92.86	0.32	1.54
NVNT	n40 SISO	5550	Ant2	91.55	0.38	1.54
NVNT	n40 SISO	5630	Ant2	92.86	0.32	1.54
NVNT	n40 SISO	5710	Ant2	91.43	0.39	1.56
NVNT	n40 SISO	5755	Ant2	91.43	0.39	1.56
NVNT	n40 SISO	5795	Ant2	91.43	0.39	1.56
NVNT	n40 MIMO	5190	Sum	92.86	0.32	1.54
NVNT	n40 MIMO	5230	Sum	91.55	0.38	1.54
NVNT	n40 MIMO	5270	Sum	91.55	0.38	1.54
NVNT	n40 MIMO	5310	Sum	92.86	0.32	1.54
NVNT	n40 MIMO	5510	Sum	92.86	0.32	1.54
NVNT	n40 MIMO	5550	Sum	92.86	0.32	1.54
NVNT	n40 MIMO	5630	Sum	92.86	0.32	1.54
NVNT	n40 MIMO	5710	Sum	92.86	0.32	1.54
NVNT	n40 MIMO	5755	Sum	91.43	0.39	1.56
NVNT	n40 MIMO	5795	Sum	92.86	0.32	1.54
NVNT	ac20 SISO	5180	Ant1	96.35	0.16	0.76
NVNT	ac20 SISO	5220	Ant1	96.32	0.16	0.76
NVNT	ac20 SISO	5240	Ant1	96.35	0.16	0.76
NVNT	ac20 SISO	5260	Ant1	96.35	0.16	0.76
NVNT	ac20 SISO	5300	Ant1	96.32	0.16	0.76
NVNT	ac20 SISO	5320	Ant1	95.62	0.19	0.76
NVNT	ac20 SISO	5500	Ant1	96.32	0.16	0.76
NVNT	ac20 SISO	5580	Ant1	96.32	0.16	0.76
NVNT	ac20 SISO	5600	Ant1	95.62	0.19	0.76
NVNT	ac20 SISO	5720	Ant1	95.62	0.19	0.76
NVNT	ac20 SISO	5745	Ant1	95.62	0.19	0.76
NVNT	ac20 SISO	5785	Ant1	95.62	0.19	0.76
NVNT	ac20 SISO	5825	Ant1	95.62	0.19	0.76



NVNT	ac20 SISO	5180	Ant2	96.32	0.16	0.76
NVNT	ac20 SISO	5220	Ant2	96.32	0.16	0.76
NVNT	ac20 SISO	5240	Ant2	96.32	0.16	0.76
NVNT	ac20 SISO	5260	Ant2	96.32	0.16	0.76
NVNT	ac20 SISO	5300	Ant2	96.32	0.16	0.76
NVNT	ac20 SISO	5320	Ant2	96.35	0.16	0.76
NVNT	ac20 SISO	5500	Ant2	95.62	0.19	0.76
NVNT	ac20 SISO	5580	Ant2	95.62	0.19	0.76
NVNT	ac20 SISO	5600	Ant2	96.32	0.16	0.76
NVNT	ac20 SISO	5720	Ant2	95.62	0.19	0.76
NVNT	ac20 SISO	5745	Ant2	96.32	0.16	0.76
NVNT	ac20 SISO	5785	Ant2	95.62	0.19	0.76
NVNT	ac20 SISO	5825	Ant2	95.62	0.19	0.76
NVNT	ac20 MIMO	5180	Sum	96.35	0.16	0.76
NVNT	ac20 MIMO	5220	Sum	96.35	0.16	0.76
NVNT	ac20 MIMO	5240	Sum	96.35	0.16	0.76
NVNT	ac20 MIMO	5260	Sum	96.35	0.16	0.76
NVNT	ac20 MIMO	5300	Sum	96.32	0.16	0.76
NVNT	ac20 MIMO	5320	Sum	95.62	0.19	0.76
NVNT	ac20 MIMO	5500	Sum	96.32	0.16	0.76
NVNT	ac20 MIMO	5580	Sum	96.35	0.16	0.76
NVNT	ac20 MIMO	5600	Sum	96.32	0.16	0.76
NVNT	ac20 MIMO	5720	Sum	96.32	0.16	0.76
NVNT	ac20 MIMO	5745	Sum	96.32	0.16	0.76
NVNT	ac20 MIMO	5785	Sum	96.32	0.16	0.76
NVNT	ac20 MIMO	5825	Sum	96.35	0.16	0.76
NVNT	ac40 SISO	5190	Ant1	92.86	0.32	1.54
NVNT	ac40 SISO	5230	Ant1	92.96	0.32	1.52
NVNT	ac40 SISO	5270	Ant1	92.96	0.32	1.52
NVNT	ac40 SISO	5310	Ant1	92.86	0.32	1.54
NVNT	ac40 SISO	5510	Ant1	92.96	0.32	1.52
NVNT	ac40 SISO	5550	Ant1	91.55	0.38	1.54
NVNT	ac40 SISO	5630	Ant1	91.55	0.38	1.54
NVNT	ac40 SISO	5710	Ant1	92.96	0.32	1.52
NVNT	ac40 SISO	5755	Ant1	91.55	0.38	1.54
NVNT	ac40 SISO	5795	Ant1	92.86	0.32	1.54
NVNT	ac40 SISO	5190	Ant2	91.55	0.38	1.54
NVNT	ac40 SISO	5230	Ant2	92.86	0.32	1.54



NVNT	ac40 SISO	5270	Ant2	92.96	0.32	1.52
NVNT	ac40 SISO	5310	Ant2	92.86	0.32	1.54
NVNT	ac40 SISO	5510	Ant2	91.55	0.38	1.54
NVNT	ac40 SISO	5550	Ant2	92.86	0.32	1.54
NVNT	ac40 SISO	5630	Ant2	92.86	0.32	1.54
NVNT	ac40 SISO	5710	Ant2	91.55	0.38	1.54
NVNT	ac40 SISO	5755	Ant2	92.86	0.32	1.54
NVNT	ac40 SISO	5795	Ant2	91.55	0.38	1.54
NVNT	ac40 MIMO	5190	Sum	92.86	0.32	1.54
NVNT	ac40 MIMO	5230	Sum	92.86	0.32	1.54
NVNT	ac40 MIMO	5270	Sum	92.86	0.32	1.54
NVNT	ac40 MIMO	5310	Sum	92.96	0.32	1.52
NVNT	ac40 MIMO	5510	Sum	92.86	0.32	1.54
NVNT	ac40 MIMO	5550	Sum	91.55	0.38	1.54
NVNT	ac40 MIMO	5630	Sum	92.86	0.32	1.54
NVNT	ac40 MIMO	5710	Sum	91.55	0.38	1.54
NVNT	ac40 MIMO	5755	Sum	91.55	0.38	1.54
NVNT	ac40 MIMO	5795	Sum	92.86	0.32	1.54
NVNT	ac80 SISO	5210	Ant1	86.84	0.61	3.03
NVNT	ac80 SISO	5290	Ant1	86.84	0.61	3.03
NVNT	ac80 SISO	5530	Ant1	86.49	0.63	3.13
NVNT	ac80 SISO	5610	Ant1	86.49	0.63	3.13
NVNT	ac80 SISO	5690	Ant1	84.21	0.75	3.13
NVNT	ac80 SISO	5775	Ant1	86.84	0.61	3.03
NVNT	ac80 SISO	5210	Ant2	86.84	0.61	3.03
NVNT	ac80 SISO	5290	Ant2	84.21	0.75	3.12
NVNT	ac80 SISO	5530	Ant2	86.49	0.63	3.13
NVNT	ac80 SISO	5610	Ant2	86.49	0.63	3.13
NVNT	ac80 SISO	5690	Ant2	86.49	0.63	3.12
NVNT	ac80 SISO	5775	Ant2	86.49	0.63	3.13
NVNT	ac80 MIMO	5210	Sum	84.21	0.75	3.13
NVNT	ac80 MIMO	5290	Sum	86.84	0.61	3.03
NVNT	ac80 MIMO	5530	Sum	86.49	0.63	3.13
NVNT	ac80 MIMO	5610	Sum	84.21	0.75	3.13
NVNT	ac80 MIMO	5690	Sum	84.21	0.75	3.13
NVNT	ac80 MIMO	5775	Sum	86.49	0.63	3.13

**A.2. Maximum Conducted Output Power**

Condition	Mode	Frequency (MHz)	Antenna	Total Conducted Power (dBm)	Total Conducted Power (W)	Limit Conducted (dBm)	Verdict
NVNT	a SISO	5180	Ant1	15.14	0.03266	24	Pass
NVNT	a SISO	5220	Ant1	15.08	0.03221	24	Pass
NVNT	a SISO	5240	Ant1	14.82	0.03034	24	Pass
NVNT	a SISO	5260	Ant1	14.89	0.03083	24	Pass
NVNT	a SISO	5300	Ant1	14.71	0.02958	24	Pass
NVNT	a SISO	5320	Ant1	14.23	0.02649	24	Pass
NVNT	a SISO	5500	Ant1	14.43	0.02773	24	Pass
NVNT	a SISO	5580	Ant1	14.49	0.02812	24	Pass
NVNT	a SISO	5600	Ant1	14.83	0.03041	24	Pass
NVNT	a SISO	5720	Ant1	15.04	0.03192	24	Pass
NVNT	a SISO	5745	Ant1	14.99	0.03155	30	Pass
NVNT	a SISO	5785	Ant1	14.63	0.02904	30	Pass
NVNT	a SISO	5825	Ant1	14.53	0.02838	30	Pass
NVNT	a SISO	5180	Ant2	14.59	0.02877	24	Pass
NVNT	a SISO	5220	Ant2	14.14	0.02594	24	Pass
NVNT	a SISO	5240	Ant2	14.12	0.02582	24	Pass
NVNT	a SISO	5260	Ant2	13.97	0.02495	24	Pass
NVNT	a SISO	5300	Ant2	13.81	0.02404	24	Pass
NVNT	a SISO	5320	Ant2	13.97	0.02495	24	Pass
NVNT	a SISO	5500	Ant2	15.17	0.03289	24	Pass
NVNT	a SISO	5580	Ant2	15.4	0.03467	24	Pass
NVNT	a SISO	5600	Ant2	15.66	0.03681	24	Pass
NVNT	a SISO	5720	Ant2	14.47	0.02799	24	Pass
NVNT	a SISO	5745	Ant2	14.47	0.02799	30	Pass
NVNT	a SISO	5785	Ant2	14.14	0.02594	30	Pass
NVNT	a SISO	5825	Ant2	15.13	0.03258	30	Pass
NVNT	n20 SISO	5180	Ant1	12.6	0.0182	24	Pass
NVNT	n20 SISO	5220	Ant1	12.56	0.01803	24	Pass
NVNT	n20 SISO	5240	Ant1	12.38	0.0173	24	Pass
NVNT	n20 SISO	5260	Ant1	13.86	0.02432	24	Pass
NVNT	n20 SISO	5300	Ant1	13.54	0.02259	24	Pass
NVNT	n20 SISO	5320	Ant1	13.15	0.02065	24	Pass
NVNT	n20 SISO	5500	Ant1	13.22	0.02099	24	Pass



NVNT	n20 SISO	5580	Ant1	13.38	0.02178	24	Pass
NVNT	n20 SISO	5600	Ant1	13.69	0.02339	24	Pass
NVNT	n20 SISO	5720	Ant1	13.95	0.02483	24	Pass
NVNT	n20 SISO	5745	Ant1	13.92	0.02466	30	Pass
NVNT	n20 SISO	5785	Ant1	13.57	0.02275	30	Pass
NVNT	n20 SISO	5825	Ant1	13.43	0.02203	30	Pass
NVNT	n20 SISO	5180	Ant2	12.02	0.01592	24	Pass
NVNT	n20 SISO	5220	Ant2	11.63	0.01455	24	Pass
NVNT	n20 SISO	5240	Ant2	11.65	0.01462	24	Pass
NVNT	n20 SISO	5260	Ant2	12.96	0.01977	24	Pass
NVNT	n20 SISO	5300	Ant2	12.64	0.01837	24	Pass
NVNT	n20 SISO	5320	Ant2	12.93	0.01963	24	Pass
NVNT	n20 SISO	5500	Ant2	14.03	0.02529	24	Pass
NVNT	n20 SISO	5580	Ant2	14.35	0.02723	24	Pass
NVNT	n20 SISO	5600	Ant2	14.47	0.02799	24	Pass
NVNT	n20 SISO	5720	Ant2	14.49	0.02812	24	Pass
NVNT	n20 SISO	5745	Ant2	14.48	0.02805	30	Pass
NVNT	n20 SISO	5785	Ant2	14.15	0.026	30	Pass
NVNT	n20 SISO	5825	Ant2	14.03	0.02529	30	Pass
NVNT	n20 MIMO	5180	Ant1	12.89	0.01945	24	Pass
NVNT	n20 MIMO	5180	Ant2	12.16	0.01644	24	Pass
NVNT	n20 MIMO	5180	Sum	15.55	0.0359	22.46	Pass
NVNT	n20 MIMO	5220	Ant1	12.71	0.01866	24	Pass
NVNT	n20 MIMO	5220	Ant2	11.87	0.01538	24	Pass
NVNT	n20 MIMO	5220	Sum	15.32	0.03405	22.46	Pass
NVNT	n20 MIMO	5240	Ant1	12.47	0.01766	24	Pass
NVNT	n20 MIMO	5240	Ant2	11.82	0.01521	24	Pass
NVNT	n20 MIMO	5240	Sum	15.17	0.03287	22.46	Pass
NVNT	n20 MIMO	5260	Ant1	13.95	0.02483	24	Pass
NVNT	n20 MIMO	5260	Ant2	13.02	0.02004	24	Pass
NVNT	n20 MIMO	5260	Sum	16.52	0.04488	22.46	Pass
NVNT	n20 MIMO	5300	Ant1	13.65	0.02317	24	Pass
NVNT	n20 MIMO	5300	Ant2	12.88	0.01941	24	Pass
NVNT	n20 MIMO	5300	Sum	16.29	0.04258	22.46	Pass
NVNT	n20 MIMO	5320	Ant1	13.24	0.02109	24	Pass
NVNT	n20 MIMO	5320	Ant2	13.15	0.02065	24	Pass
NVNT	n20 MIMO	5320	Sum	16.21	0.04174	22.46	Pass
NVNT	n20 MIMO	5500	Ant1	13.36	0.02168	24	Pass





NVNT	n20 MIMO	5500	Ant2	14.24	0.02655	24	Pass
NVNT	n20 MIMO	5500	Sum	16.83	0.04822	22.46	Pass
NVNT	n20 MIMO	5580	Ant1	13.59	0.02286	24	Pass
NVNT	n20 MIMO	5580	Ant2	14.58	0.02871	24	Pass
NVNT	n20 MIMO	5580	Sum	17.12	0.05156	22.46	Pass
NVNT	n20 MIMO	5600	Ant1	13.88	0.02443	24	Pass
NVNT	n20 MIMO	5600	Ant2	14.82	0.03034	24	Pass
NVNT	n20 MIMO	5600	Sum	17.39	0.05477	22.46	Pass
NVNT	n20 MIMO	5720	Ant1	14.1	0.0257	24	Pass
NVNT	n20 MIMO	5720	Ant2	14.63	0.02904	24	Pass
NVNT	n20 MIMO	5720	Sum	17.38	0.05474	22.46	Pass
NVNT	n20 MIMO	5745	Ant1	14.02	0.02523	30	Pass
NVNT	n20 MIMO	5745	Ant2	14.68	0.02938	30	Pass
NVNT	n20 MIMO	5745	Sum	17.37	0.05461	28.46	Pass
NVNT	n20 MIMO	5785	Ant1	13.7	0.02344	30	Pass
NVNT	n20 MIMO	5785	Ant2	14.43	0.02773	30	Pass
NVNT	n20 MIMO	5785	Sum	17.09	0.05118	28.46	Pass
NVNT	n20 MIMO	5825	Ant1	13.47	0.02223	30	Pass
NVNT	n20 MIMO	5825	Ant2	14.25	0.02661	30	Pass
NVNT	n20 MIMO	5825	Sum	16.89	0.04884	28.46	Pass
NVNT	n40 SISO	5190	Ant1	13.1	0.02042	24	Pass
NVNT	n40 SISO	5230	Ant1	13.09	0.02037	24	Pass
NVNT	n40 SISO	5270	Ant1	12.86	0.01932	24	Pass
NVNT	n40 SISO	5310	Ant1	12.53	0.01791	24	Pass
NVNT	n40 SISO	5510	Ant1	12.42	0.01746	24	Pass
NVNT	n40 SISO	5550	Ant1	12.38	0.0173	24	Pass
NVNT	n40 SISO	5630	Ant1	13.08	0.02032	24	Pass
NVNT	n40 SISO	5710	Ant1	13.28	0.02128	24	Pass
NVNT	n40 SISO	5755	Ant1	13.36	0.02168	30	Pass
NVNT	n40 SISO	5795	Ant1	12.76	0.01888	30	Pass
NVNT	n40 SISO	5190	Ant2	12.52	0.01786	24	Pass
NVNT	n40 SISO	5230	Ant2	12.27	0.01687	24	Pass
NVNT	n40 SISO	5270	Ant2	12.2	0.0166	24	Pass
NVNT	n40 SISO	5310	Ant2	11.91	0.01552	24	Pass
NVNT	n40 SISO	5510	Ant2	13.1	0.02042	24	Pass
NVNT	n40 SISO	5550	Ant2	13.14	0.02061	24	Pass
NVNT	n40 SISO	5630	Ant2	13.82	0.0241	24	Pass
NVNT	n40 SISO	5710	Ant2	13.74	0.02366	24	Pass



NVNT	n40 SISO	5755	Ant2	13.59	0.02286	30	Pass
NVNT	n40 SISO	5795	Ant2	13.31	0.02143	30	Pass
NVNT	n40 MIMO	5190	Ant1	13.29	0.02133	24	Pass
NVNT	n40 MIMO	5190	Ant2	12.55	0.01799	24	Pass
NVNT	n40 MIMO	5190	Sum	15.95	0.03932	22.46	Pass
NVNT	n40 MIMO	5230	Ant1	13.2	0.02089	24	Pass
NVNT	n40 MIMO	5230	Ant2	12.32	0.01706	24	Pass
NVNT	n40 MIMO	5230	Sum	15.79	0.03795	22.46	Pass
NVNT	n40 MIMO	5270	Ant1	12.91	0.01954	24	Pass
NVNT	n40 MIMO	5270	Ant2	12.22	0.01667	24	Pass
NVNT	n40 MIMO	5270	Sum	15.59	0.03622	22.46	Pass
NVNT	n40 MIMO	5310	Ant1	12.6	0.0182	24	Pass
NVNT	n40 MIMO	5310	Ant2	11.83	0.01524	24	Pass
NVNT	n40 MIMO	5310	Sum	15.24	0.03344	22.46	Pass
NVNT	n40 MIMO	5510	Ant1	12.56	0.01803	24	Pass
NVNT	n40 MIMO	5510	Ant2	13.05	0.02018	24	Pass
NVNT	n40 MIMO	5510	Sum	15.82	0.03821	22.46	Pass
NVNT	n40 MIMO	5550	Ant1	12.59	0.01816	24	Pass
NVNT	n40 MIMO	5550	Ant2	13.18	0.0208	24	Pass
NVNT	n40 MIMO	5550	Sum	15.91	0.03895	22.46	Pass
NVNT	n40 MIMO	5630	Ant1	13.22	0.02099	24	Pass
NVNT	n40 MIMO	5630	Ant2	13.79	0.02393	24	Pass
NVNT	n40 MIMO	5630	Sum	16.52	0.04492	22.46	Pass
NVNT	n40 MIMO	5710	Ant1	13.34	0.02158	24	Pass
NVNT	n40 MIMO	5710	Ant2	13.74	0.02366	24	Pass
NVNT	n40 MIMO	5710	Sum	16.56	0.04524	22.46	Pass
NVNT	n40 MIMO	5755	Ant1	13.44	0.02208	30	Pass
NVNT	n40 MIMO	5755	Ant2	13.78	0.02388	30	Pass
NVNT	n40 MIMO	5755	Sum	16.62	0.04596	28.46	Pass
NVNT	n40 MIMO	5795	Ant1	12.94	0.01968	30	Pass
NVNT	n40 MIMO	5795	Ant2	13.43	0.02203	30	Pass
NVNT	n40 MIMO	5795	Sum	16.2	0.04171	28.46	Pass
NVNT	ac20 SISO	5180	Ant1	12.74	0.01879	24	Pass
NVNT	ac20 SISO	5220	Ant1	12.56	0.01803	24	Pass
NVNT	ac20 SISO	5240	Ant1	12.32	0.01706	24	Pass
NVNT	ac20 SISO	5260	Ant1	13.79	0.02393	24	Pass
NVNT	ac20 SISO	5300	Ant1	13.53	0.02254	24	Pass
NVNT	ac20 SISO	5320	Ant1	13.13	0.02056	24	Pass



NVNT	ac20 SISO	5500	Ant1	13.35	0.02163	24	Pass
NVNT	ac20 SISO	5580	Ant1	13.46	0.02218	24	Pass
NVNT	ac20 SISO	5600	Ant1	13.72	0.02355	24	Pass
NVNT	ac20 SISO	5720	Ant1	13.99	0.02506	24	Pass
NVNT	ac20 SISO	5745	Ant1	13.95	0.02483	30	Pass
NVNT	ac20 SISO	5785	Ant1	13.55	0.02265	30	Pass
NVNT	ac20 SISO	5825	Ant1	13.41	0.02193	30	Pass
NVNT	ac20 SISO	5180	Ant2	12.02	0.01592	24	Pass
NVNT	ac20 SISO	5220	Ant2	11.67	0.01469	24	Pass
NVNT	ac20 SISO	5240	Ant2	11.68	0.01472	24	Pass
NVNT	ac20 SISO	5260	Ant2	12.89	0.01945	24	Pass
NVNT	ac20 SISO	5300	Ant2	12.68	0.01854	24	Pass
NVNT	ac20 SISO	5320	Ant2	12.84	0.01923	24	Pass
NVNT	ac20 SISO	5500	Ant2	14.04	0.02535	24	Pass
NVNT	ac20 SISO	5580	Ant2	14.34	0.02716	24	Pass
NVNT	ac20 SISO	5600	Ant2	14.46	0.02793	24	Pass
NVNT	ac20 SISO	5720	Ant2	14.46	0.02793	24	Pass
NVNT	ac20 SISO	5745	Ant2	14.44	0.0278	30	Pass
NVNT	ac20 SISO	5785	Ant2	14.13	0.02588	30	Pass
NVNT	ac20 SISO	5825	Ant2	13.99	0.02506	30	Pass
NVNT	ac20 MIMO	5180	Ant1	12.85	0.01928	24	Pass
NVNT	ac20 MIMO	5180	Ant2	12.23	0.01671	24	Pass
NVNT	ac20 MIMO	5180	Sum	15.56	0.03599	22.46	Pass
NVNT	ac20 MIMO	5220	Ant1	12.73	0.01875	24	Pass
NVNT	ac20 MIMO	5220	Ant2	11.88	0.01542	24	Pass
NVNT	ac20 MIMO	5220	Sum	15.34	0.03417	22.46	Pass
NVNT	ac20 MIMO	5240	Ant1	12.48	0.0177	24	Pass
NVNT	ac20 MIMO	5240	Ant2	11.9	0.01549	24	Pass
NVNT	ac20 MIMO	5240	Sum	15.21	0.03319	22.46	Pass
NVNT	ac20 MIMO	5260	Ant1	13.98	0.025	24	Pass
NVNT	ac20 MIMO	5260	Ant2	13.15	0.02065	24	Pass
NVNT	ac20 MIMO	5260	Sum	16.6	0.04566	22.46	Pass
NVNT	ac20 MIMO	5300	Ant1	13.69	0.02339	24	Pass
NVNT	ac20 MIMO	5300	Ant2	12.83	0.01919	24	Pass
NVNT	ac20 MIMO	5300	Sum	16.29	0.04258	22.46	Pass
NVNT	ac20 MIMO	5320	Ant1	13.27	0.02123	24	Pass
NVNT	ac20 MIMO	5320	Ant2	13.17	0.02075	24	Pass
NVNT	ac20 MIMO	5320	Sum	16.23	0.04198	22.46	Pass



NVNT	ac20 MIMO	5500	Ant1	13.38	0.02178	24	Pass
NVNT	ac20 MIMO	5500	Ant2	14.26	0.02667	24	Pass
NVNT	ac20 MIMO	5500	Sum	16.85	0.04845	22.46	Pass
NVNT	ac20 MIMO	5580	Ant1	13.57	0.02275	24	Pass
NVNT	ac20 MIMO	5580	Ant2	14.59	0.02877	24	Pass
NVNT	ac20 MIMO	5580	Sum	17.12	0.05152	22.46	Pass
NVNT	ac20 MIMO	5600	Ant1	13.87	0.02438	24	Pass
NVNT	ac20 MIMO	5600	Ant2	14.89	0.03083	24	Pass
NVNT	ac20 MIMO	5600	Sum	17.42	0.05521	22.46	Pass
NVNT	ac20 MIMO	5720	Ant1	14.07	0.02553	24	Pass
NVNT	ac20 MIMO	5720	Ant2	14.69	0.02944	24	Pass
NVNT	ac20 MIMO	5720	Sum	17.4	0.05497	22.46	Pass
NVNT	ac20 MIMO	5745	Ant1	14.01	0.02518	30	Pass
NVNT	ac20 MIMO	5745	Ant2	14.68	0.02938	30	Pass
NVNT	ac20 MIMO	5745	Sum	17.37	0.05455	28.46	Pass
NVNT	ac20 MIMO	5785	Ant1	13.75	0.02371	30	Pass
NVNT	ac20 MIMO	5785	Ant2	14.41	0.02761	30	Pass
NVNT	ac20 MIMO	5785	Sum	17.1	0.05132	28.46	Pass
NVNT	ac20 MIMO	5825	Ant1	13.48	0.02228	30	Pass
NVNT	ac20 MIMO	5825	Ant2	14.35	0.02723	30	Pass
NVNT	ac20 MIMO	5825	Sum	16.95	0.04951	28.46	Pass
NVNT	ac40 SISO	5190	Ant1	13.12	0.02051	24	Pass
NVNT	ac40 SISO	5230	Ant1	13.08	0.02032	24	Pass
NVNT	ac40 SISO	5270	Ant1	12.84	0.01923	24	Pass
NVNT	ac40 SISO	5310	Ant1	12.53	0.01791	24	Pass
NVNT	ac40 SISO	5510	Ant1	12.3	0.01698	24	Pass
NVNT	ac40 SISO	5550	Ant1	12.44	0.01754	24	Pass
NVNT	ac40 SISO	5630	Ant1	13.15	0.02065	24	Pass
NVNT	ac40 SISO	5710	Ant1	13.22	0.02099	24	Pass
NVNT	ac40 SISO	5755	Ant1	13.32	0.02148	30	Pass
NVNT	ac40 SISO	5795	Ant1	12.81	0.0191	30	Pass
NVNT	ac40 SISO	5190	Ant2	12.49	0.01774	24	Pass
NVNT	ac40 SISO	5230	Ant2	12.24	0.01675	24	Pass
NVNT	ac40 SISO	5270	Ant2	12.2	0.0166	24	Pass
NVNT	ac40 SISO	5310	Ant2	11.91	0.01552	24	Pass
NVNT	ac40 SISO	5510	Ant2	13.06	0.02023	24	Pass
NVNT	ac40 SISO	5550	Ant2	13.11	0.02046	24	Pass
NVNT	ac40 SISO	5630	Ant2	13.8	0.02399	24	Pass



NVNT	ac40 SISO	5710	Ant2	13.72	0.02355	24	Pass
NVNT	ac40 SISO	5755	Ant2	13.68	0.02333	30	Pass
NVNT	ac40 SISO	5795	Ant2	13.37	0.02173	30	Pass
NVNT	ac40 MIMO	5190	Ant1	13.29	0.02133	24	Pass
NVNT	ac40 MIMO	5190	Ant2	12.52	0.01786	24	Pass
NVNT	ac40 MIMO	5190	Sum	15.93	0.0392	22.46	Pass
NVNT	ac40 MIMO	5230	Ant1	13.22	0.02099	24	Pass
NVNT	ac40 MIMO	5230	Ant2	12.31	0.01702	24	Pass
NVNT	ac40 MIMO	5230	Sum	15.8	0.03801	22.46	Pass
NVNT	ac40 MIMO	5270	Ant1	12.98	0.01986	24	Pass
NVNT	ac40 MIMO	5270	Ant2	12.24	0.01675	24	Pass
NVNT	ac40 MIMO	5270	Sum	15.64	0.03661	22.46	Pass
NVNT	ac40 MIMO	5310	Ant1	12.64	0.01837	24	Pass
NVNT	ac40 MIMO	5310	Ant2	11.88	0.01542	24	Pass
NVNT	ac40 MIMO	5310	Sum	15.29	0.03378	22.46	Pass
NVNT	ac40 MIMO	5510	Ant1	12.51	0.01782	24	Pass
NVNT	ac40 MIMO	5510	Ant2	13.12	0.02051	24	Pass
NVNT	ac40 MIMO	5510	Sum	15.84	0.03834	22.46	Pass
NVNT	ac40 MIMO	5550	Ant1	12.59	0.01816	24	Pass
NVNT	ac40 MIMO	5550	Ant2	13.18	0.0208	24	Pass
NVNT	ac40 MIMO	5550	Sum	15.91	0.03895	22.46	Pass
NVNT	ac40 MIMO	5630	Ant1	13.23	0.02104	24	Pass
NVNT	ac40 MIMO	5630	Ant2	13.84	0.02421	24	Pass
NVNT	ac40 MIMO	5630	Sum	16.56	0.04525	22.46	Pass
NVNT	ac40 MIMO	5710	Ant1	13.25	0.02113	24	Pass
NVNT	ac40 MIMO	5710	Ant2	13.8	0.02399	24	Pass
NVNT	ac40 MIMO	5710	Sum	16.54	0.04512	22.46	Pass
NVNT	ac40 MIMO	5755	Ant1	13.47	0.02223	30	Pass
NVNT	ac40 MIMO	5755	Ant2	13.73	0.0236	30	Pass
NVNT	ac40 MIMO	5755	Sum	16.61	0.04584	28.46	Pass
NVNT	ac40 MIMO	5795	Ant1	12.95	0.01972	30	Pass
NVNT	ac40 MIMO	5795	Ant2	13.47	0.02223	30	Pass
NVNT	ac40 MIMO	5795	Sum	16.23	0.04196	28.46	Pass
NVNT	ac80 SISO	5210	Ant1	9.34	0.00859	24	Pass
NVNT	ac80 SISO	5290	Ant1	8.93	0.00782	24	Pass
NVNT	ac80 SISO	5530	Ant1	8.67	0.00736	24	Pass
NVNT	ac80 SISO	5610	Ant1	9.01	0.00796	24	Pass
NVNT	ac80 SISO	5690	Ant1	9.39	0.00869	24	Pass



NVNT	ac80 SISO	5775	Ant1	9.06	0.00805	30	Pass
NVNT	ac80 SISO	5210	Ant2	8.42	0.00695	24	Pass
NVNT	ac80 SISO	5290	Ant2	7.99	0.0063	24	Pass
NVNT	ac80 SISO	5530	Ant2	9.23	0.00838	24	Pass
NVNT	ac80 SISO	5610	Ant2	10.19	0.01045	24	Pass
NVNT	ac80 SISO	5690	Ant2	10.04	0.01009	24	Pass
NVNT	ac80 SISO	5775	Ant2	9.38	0.00867	30	Pass
NVNT	ac80 MIMO	5210	Ant1	9.44	0.00879	24	Pass
NVNT	ac80 MIMO	5210	Ant2	8.46	0.00701	24	Pass
NVNT	ac80 MIMO	5210	Sum	11.99	0.0158	22.46	Pass
NVNT	ac80 MIMO	5290	Ant1	9	0.00794	24	Pass
NVNT	ac80 MIMO	5290	Ant2	8.01	0.00632	24	Pass
NVNT	ac80 MIMO	5290	Sum	11.54	0.01427	22.46	Pass
NVNT	ac80 MIMO	5530	Ant1	8.84	0.00766	24	Pass
NVNT	ac80 MIMO	5530	Ant2	9.18	0.00828	24	Pass
NVNT	ac80 MIMO	5530	Sum	12.02	0.01594	22.46	Pass
NVNT	ac80 MIMO	5610	Ant1	9.19	0.0083	24	Pass
NVNT	ac80 MIMO	5610	Ant2	10.24	0.01057	24	Pass
NVNT	ac80 MIMO	5610	Sum	12.76	0.01887	22.46	Pass
NVNT	ac80 MIMO	5690	Ant1	9.78	0.00951	24	Pass
NVNT	ac80 MIMO	5690	Ant2	10.15	0.01035	24	Pass
NVNT	ac80 MIMO	5690	Sum	12.98	0.01986	22.46	Pass
NVNT	ac80 MIMO	5775	Ant1	9.29	0.00849	30	Pass
NVNT	ac80 MIMO	5775	Ant2	9.42	0.00875	30	Pass
NVNT	ac80 MIMO	5775	Sum	12.37	0.01724	28.46	Pass

**Note:** Directional gain =  $10\log[(10^{G0/20} + 10^{G1/20})^2/2] = 7.54\text{dBi} > 6\text{dBi}$ , so the power limit shall be reduced to  $24 - (7.54 - 6) = 22.46\text{dBm}$  for 5.18-5.24GHz, 5.260-5.320GHz, 5.500-5.720GHz band and reduced to  $30 - (7.54 - 6) = 28.46\text{dBm}$  for 5.745-5.825GHz band.

**A.3. Emission Bandwidth**

Condition	Mode	Frequency (MHz)	Antenna	-26 dB Bandwidth (MHz)	Verdict
NVNT	a SISO	5180	Ant1	20.055	Pass
NVNT	a SISO	5220	Ant1	20.15	Pass
NVNT	a SISO	5240	Ant1	20.022	Pass
NVNT	a SISO	5260	Ant1	20.023	Pass
NVNT	a SISO	5300	Ant1	20.108	Pass
NVNT	a SISO	5320	Ant1	20.007	Pass
NVNT	a SISO	5500	Ant1	20.018	Pass
NVNT	a SISO	5580	Ant1	20.276	Pass
NVNT	a SISO	5600	Ant1	20.153	Pass
NVNT	a SISO	5720	Ant1	19.937	Pass
NVNT	a SISO	5180	Ant2	19.912	Pass
NVNT	a SISO	5220	Ant2	20.222	Pass
NVNT	a SISO	5240	Ant2	20.317	Pass
NVNT	a SISO	5260	Ant2	20.311	Pass
NVNT	a SISO	5300	Ant2	20.177	Pass
NVNT	a SISO	5320	Ant2	19.947	Pass
NVNT	a SISO	5500	Ant2	19.988	Pass
NVNT	a SISO	5580	Ant2	20.208	Pass
NVNT	a SISO	5600	Ant2	20.027	Pass
NVNT	a SISO	5720	Ant2	20.34	Pass
NVNT	n20 SISO	5180	Ant1	20.411	Pass
NVNT	n20 SISO	5220	Ant1	20.346	Pass
NVNT	n20 SISO	5240	Ant1	20.375	Pass
NVNT	n20 SISO	5260	Ant1	20.271	Pass
NVNT	n20 SISO	5300	Ant1	20.413	Pass
NVNT	n20 SISO	5320	Ant1	20.385	Pass
NVNT	n20 SISO	5500	Ant1	20.32	Pass
NVNT	n20 SISO	5580	Ant1	20.403	Pass
NVNT	n20 SISO	5600	Ant1	20.463	Pass
NVNT	n20 SISO	5720	Ant1	20.486	Pass
NVNT	n20 SISO	5180	Ant2	20.269	Pass
NVNT	n20 SISO	5220	Ant2	20.324	Pass
NVNT	n20 SISO	5240	Ant2	20.376	Pass
NVNT	n20 SISO	5260	Ant2	20.475	Pass
NVNT	n20 SISO	5300	Ant2	20.312	Pass



NVNT	n20 SISO	5320	Ant2	20.341	Pass
NVNT	n20 SISO	5500	Ant2	20.411	Pass
NVNT	n20 SISO	5580	Ant2	20.463	Pass
NVNT	n20 SISO	5600	Ant2	20.52	Pass
NVNT	n20 SISO	5720	Ant2	20.446	Pass
NVNT	n20 MIMO	5180	Ant1	20.482	Pass
NVNT	n20 MIMO	5180	Ant2	20.195	Pass
NVNT	n20 MIMO	5220	Ant1	20.416	Pass
NVNT	n20 MIMO	5220	Ant2	20.089	Pass
NVNT	n20 MIMO	5240	Ant1	20.35	Pass
NVNT	n20 MIMO	5240	Ant2	20.037	Pass
NVNT	n20 MIMO	5260	Ant1	20.428	Pass
NVNT	n20 MIMO	5260	Ant2	20.266	Pass
NVNT	n20 MIMO	5300	Ant1	20.4	Pass
NVNT	n20 MIMO	5300	Ant2	20.203	Pass
NVNT	n20 MIMO	5320	Ant1	20.375	Pass
NVNT	n20 MIMO	5320	Ant2	20.019	Pass
NVNT	n20 MIMO	5500	Ant1	20.51	Pass
NVNT	n20 MIMO	5500	Ant2	19.932	Pass
NVNT	n20 MIMO	5580	Ant1	20.397	Pass
NVNT	n20 MIMO	5580	Ant2	20.105	Pass
NVNT	n20 MIMO	5600	Ant1	20.253	Pass
NVNT	n20 MIMO	5600	Ant2	20.117	Pass
NVNT	n20 MIMO	5720	Ant1	20.443	Pass
NVNT	n20 MIMO	5720	Ant2	20.22	Pass
NVNT	n40 SISO	5190	Ant1	41.164	Pass
NVNT	n40 SISO	5230	Ant1	41.068	Pass
NVNT	n40 SISO	5270	Ant1	40.795	Pass
NVNT	n40 SISO	5310	Ant1	40.669	Pass
NVNT	n40 SISO	5510	Ant1	40.748	Pass
NVNT	n40 SISO	5550	Ant1	40.893	Pass
NVNT	n40 SISO	5630	Ant1	41.277	Pass
NVNT	n40 SISO	5710	Ant1	40.586	Pass
NVNT	n40 SISO	5190	Ant2	40.787	Pass
NVNT	n40 SISO	5230	Ant2	41.034	Pass
NVNT	n40 SISO	5270	Ant2	40.963	Pass
NVNT	n40 SISO	5310	Ant2	40.984	Pass
NVNT	n40 SISO	5510	Ant2	40.949	Pass





NVNT	n40 SISO	5550	Ant2	40.55	Pass
NVNT	n40 SISO	5630	Ant2	40.852	Pass
NVNT	n40 SISO	5710	Ant2	40.894	Pass
NVNT	ac20 SISO	5180	Ant1	20.317	Pass
NVNT	ac20 SISO	5220	Ant1	20.423	Pass
NVNT	ac20 SISO	5240	Ant1	20.347	Pass
NVNT	ac20 SISO	5260	Ant1	20.397	Pass
NVNT	ac20 SISO	5300	Ant1	20.389	Pass
NVNT	ac20 SISO	5320	Ant1	20.479	Pass
NVNT	ac20 SISO	5500	Ant1	20.281	Pass
NVNT	ac20 SISO	5580	Ant1	20.468	Pass
NVNT	ac20 SISO	5600	Ant1	20.292	Pass
NVNT	ac20 SISO	5720	Ant1	20.496	Pass
NVNT	ac20 SISO	5180	Ant2	20.381	Pass
NVNT	ac20 SISO	5220	Ant2	20.422	Pass
NVNT	ac20 SISO	5240	Ant2	20.42	Pass
NVNT	ac20 SISO	5260	Ant2	20.463	Pass
NVNT	ac20 SISO	5300	Ant2	20.613	Pass
NVNT	ac20 SISO	5320	Ant2	20.383	Pass
NVNT	ac20 SISO	5500	Ant2	20.429	Pass
NVNT	ac20 SISO	5580	Ant2	20.504	Pass
NVNT	ac20 SISO	5600	Ant2	20.262	Pass
NVNT	ac20 SISO	5720	Ant2	20.385	Pass
NVNT	ac20 MIMO	5180	Ant1	20.433	Pass
NVNT	ac20 MIMO	5180	Ant2	19.966	Pass
NVNT	ac20 MIMO	5220	Ant1	20.303	Pass
NVNT	ac20 MIMO	5220	Ant2	20.022	Pass
NVNT	ac20 MIMO	5240	Ant1	20.432	Pass
NVNT	ac20 MIMO	5240	Ant2	20.156	Pass
NVNT	ac20 MIMO	5260	Ant1	20.312	Pass
NVNT	ac20 MIMO	5260	Ant2	20.132	Pass
NVNT	ac20 MIMO	5300	Ant1	20.44	Pass
NVNT	ac20 MIMO	5300	Ant2	20.192	Pass
NVNT	ac20 MIMO	5320	Ant1	20.472	Pass
NVNT	ac20 MIMO	5320	Ant2	19.973	Pass
NVNT	ac20 MIMO	5500	Ant1	20.415	Pass
NVNT	ac20 MIMO	5500	Ant2	20.051	Pass
NVNT	ac20 MIMO	5580	Ant1	20.474	Pass



NVNT	ac20 MIMO	5580	Ant2	20.196	Pass
NVNT	ac20 MIMO	5600	Ant1	20.433	Pass
NVNT	ac20 MIMO	5600	Ant2	19.931	Pass
NVNT	ac20 MIMO	5720	Ant1	20.391	Pass
NVNT	ac20 MIMO	5720	Ant2	19.977	Pass
NVNT	ac40 SISO	5190	Ant1	40.791	Pass
NVNT	ac40 SISO	5230	Ant1	40.883	Pass
NVNT	ac40 SISO	5270	Ant1	40.672	Pass
NVNT	ac40 SISO	5310	Ant1	40.479	Pass
NVNT	ac40 SISO	5510	Ant1	40.541	Pass
NVNT	ac40 SISO	5550	Ant1	41.245	Pass
NVNT	ac40 SISO	5630	Ant1	40.64	Pass
NVNT	ac40 SISO	5710	Ant1	40.893	Pass
NVNT	ac40 SISO	5190	Ant2	40.813	Pass
NVNT	ac40 SISO	5230	Ant2	41.114	Pass
NVNT	ac40 SISO	5270	Ant2	40.676	Pass
NVNT	ac40 SISO	5310	Ant2	40.488	Pass
NVNT	ac40 SISO	5510	Ant2	40.982	Pass
NVNT	ac40 SISO	5550	Ant2	40.472	Pass
NVNT	ac40 SISO	5630	Ant2	40.974	Pass
NVNT	ac40 SISO	5710	Ant2	40.633	Pass
NVNT	ac80 SISO	5210	Ant1	82.298	Pass
NVNT	ac80 SISO	5290	Ant1	82.4	Pass
NVNT	ac80 SISO	5530	Ant1	82.429	Pass
NVNT	ac80 SISO	5610	Ant1	82.208	Pass
NVNT	ac80 SISO	5690	Ant1	82.276	Pass
NVNT	ac80 SISO	5210	Ant2	82.055	Pass
NVNT	ac80 SISO	5290	Ant2	81.957	Pass
NVNT	ac80 SISO	5530	Ant2	82.583	Pass
NVNT	ac80 SISO	5610	Ant2	81.966	Pass
NVNT	ac80 SISO	5690	Ant2	81.946	Pass



Condition	Mode	Frequency (MHz)	Antenna	-6 dB Bandwidth (MHz)	Limit -6 dB Bandwidth (MHz)	Verdict
NVNT	a SISO	5745	Ant1	15.047	0.5	Pass
NVNT	a SISO	5785	Ant1	15.071	0.5	Pass
NVNT	a SISO	5825	Ant1	15.086	0.5	Pass
NVNT	a SISO	5745	Ant2	15.059	0.5	Pass
NVNT	a SISO	5785	Ant2	13.895	0.5	Pass
NVNT	a SISO	5825	Ant2	15.076	0.5	Pass
NVNT	n20 SISO	5745	Ant1	14.977	0.5	Pass
NVNT	n20 SISO	5785	Ant1	15.021	0.5	Pass
NVNT	n20 SISO	5825	Ant1	13.755	0.5	Pass
NVNT	n20 SISO	5745	Ant2	15.09	0.5	Pass
NVNT	n20 SISO	5785	Ant2	13.779	0.5	Pass
NVNT	n20 SISO	5825	Ant2	15.051	0.5	Pass
NVNT	n20 MIMO	5745	Ant1	13.844	0.5	Pass
NVNT	n20 MIMO	5745	Ant2	15.653	0.5	Pass
NVNT	n20 MIMO	5785	Ant1	13.86	0.5	Pass
NVNT	n20 MIMO	5785	Ant2	15.666	0.5	Pass
NVNT	n20 MIMO	5825	Ant1	15.093	0.5	Pass
NVNT	n20 MIMO	5825	Ant2	15.024	0.5	Pass
NVNT	n40 SISO	5755	Ant1	33.84	0.5	Pass
NVNT	n40 SISO	5795	Ant1	35.135	0.5	Pass
NVNT	n40 SISO	5755	Ant2	35.131	0.5	Pass
NVNT	n40 SISO	5795	Ant2	34.931	0.5	Pass
NVNT	ac20 SISO	5745	Ant1	15.031	0.5	Pass
NVNT	ac20 SISO	5785	Ant1	14.969	0.5	Pass
NVNT	ac20 SISO	5825	Ant1	15.008	0.5	Pass
NVNT	ac20 SISO	5745	Ant2	15.072	0.5	Pass
NVNT	ac20 SISO	5785	Ant2	15.047	0.5	Pass
NVNT	ac20 SISO	5825	Ant2	15.012	0.5	Pass
NVNT	ac20 MIMO	5745	Ant1	15.099	0.5	Pass
NVNT	ac20 MIMO	5745	Ant2	14.788	0.5	Pass
NVNT	ac20 MIMO	5785	Ant1	17.282	0.5	Pass
NVNT	ac20 MIMO	5785	Ant2	15.059	0.5	Pass
NVNT	ac20 MIMO	5825	Ant1	14.625	0.5	Pass
NVNT	ac20 MIMO	5825	Ant2	16.299	0.5	Pass
NVNT	ac40 SISO	5755	Ant1	35.11	0.5	Pass



REPORT No.: SZ24030326W04

NVNT	ac40 SISO	5795	Ant1	33.876	0.5	Pass
NVNT	ac40 SISO	5755	Ant2	35.051	0.5	Pass
NVNT	ac40 SISO	5795	Ant2	32.605	0.5	Pass
NVNT	ac80 SISO	5775	Ant1	75.124	0.5	Pass
NVNT	ac80 SISO	5775	Ant2	75.082	0.5	Pass



Test Graphs

-26dB Bandwidth NVNT a 5180MHz Ant1 SISO



-26dB Bandwidth NVNT a 5220MHz Ant1 SISO

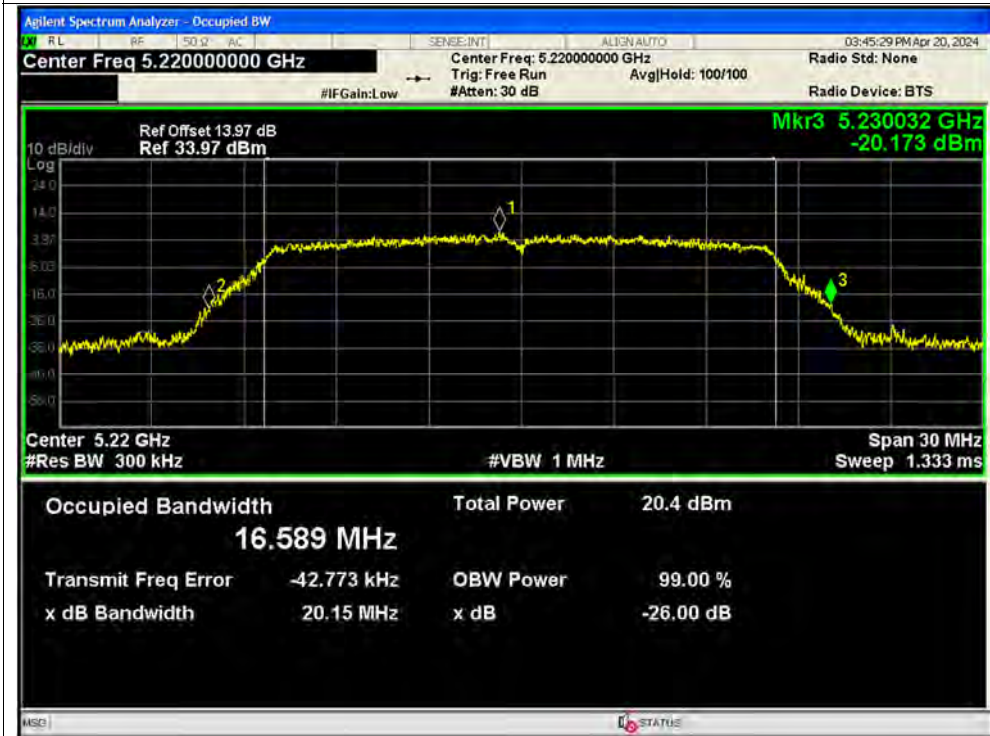



-26dB Bandwidth NVNT a 5240MHz Ant1 SISO

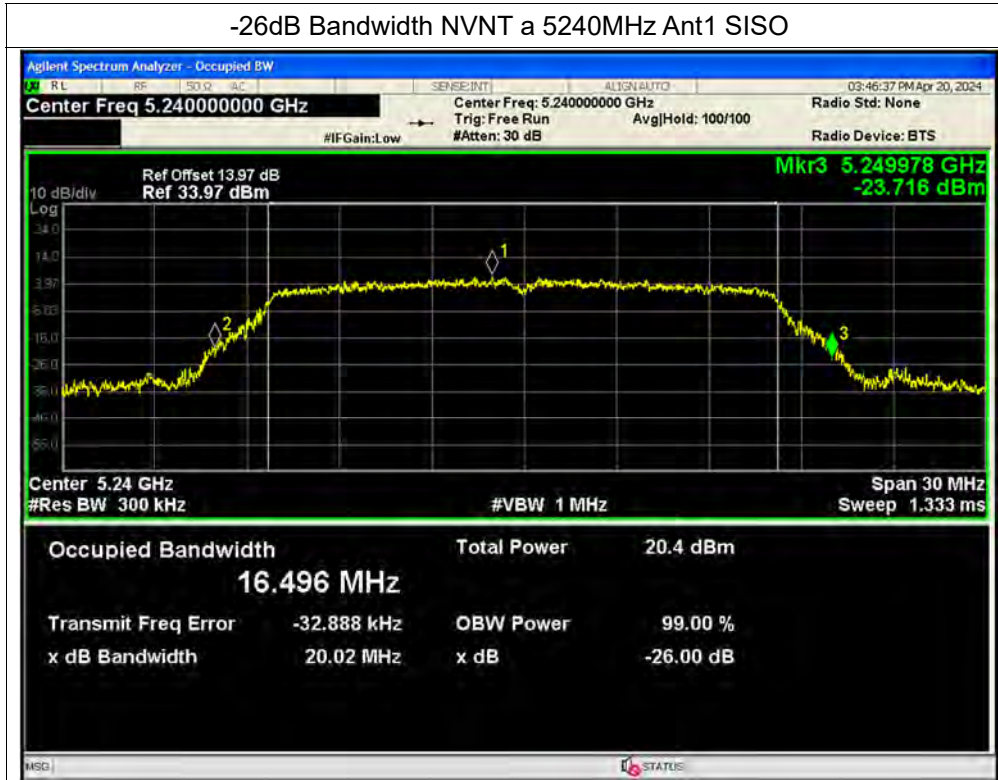

-26dB Bandwidth NVNT a 5260MHz Ant1 SISO





-26dB Bandwidth NVNT a 5300MHz Ant1 SISO

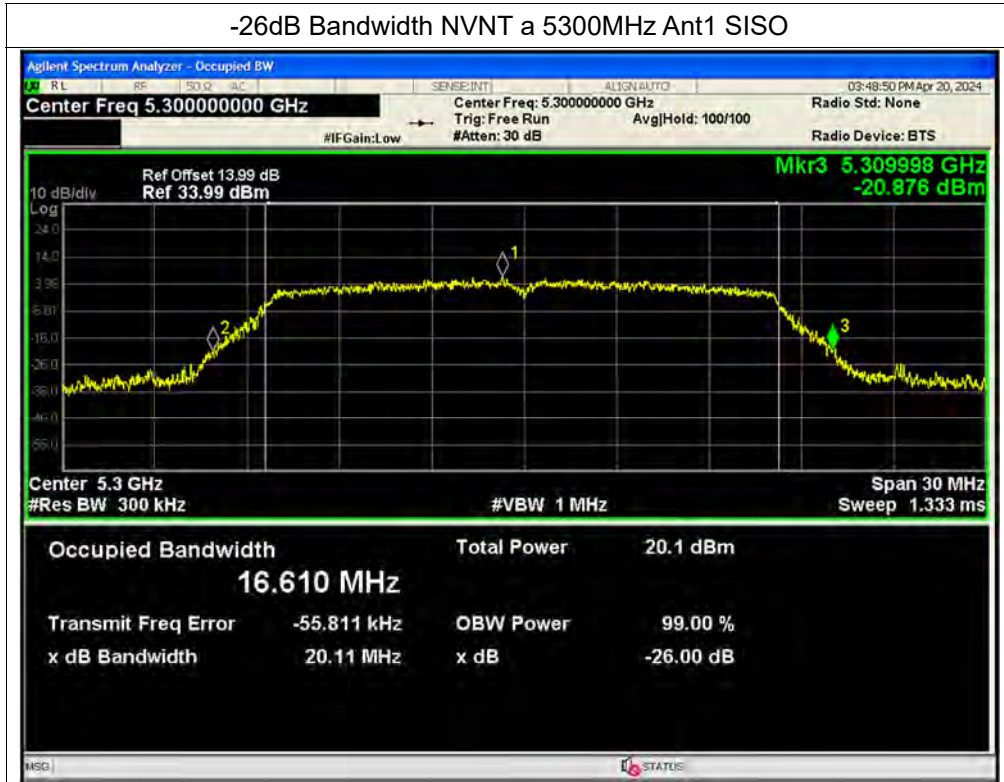

-26dB Bandwidth NVNT a 5320MHz Ant1 SISO





-26dB Bandwidth NVNT a 5500MHz Ant1 SISO



-26dB Bandwidth NVNT a 5580MHz Ant1 SISO







-26dB Bandwidth NVNT a 5600MHz Ant1 SISO



-26dB Bandwidth NVNT a 5720MHz Ant1 SISO





-26dB Bandwidth NVNT a 5180MHz Ant2 SISO

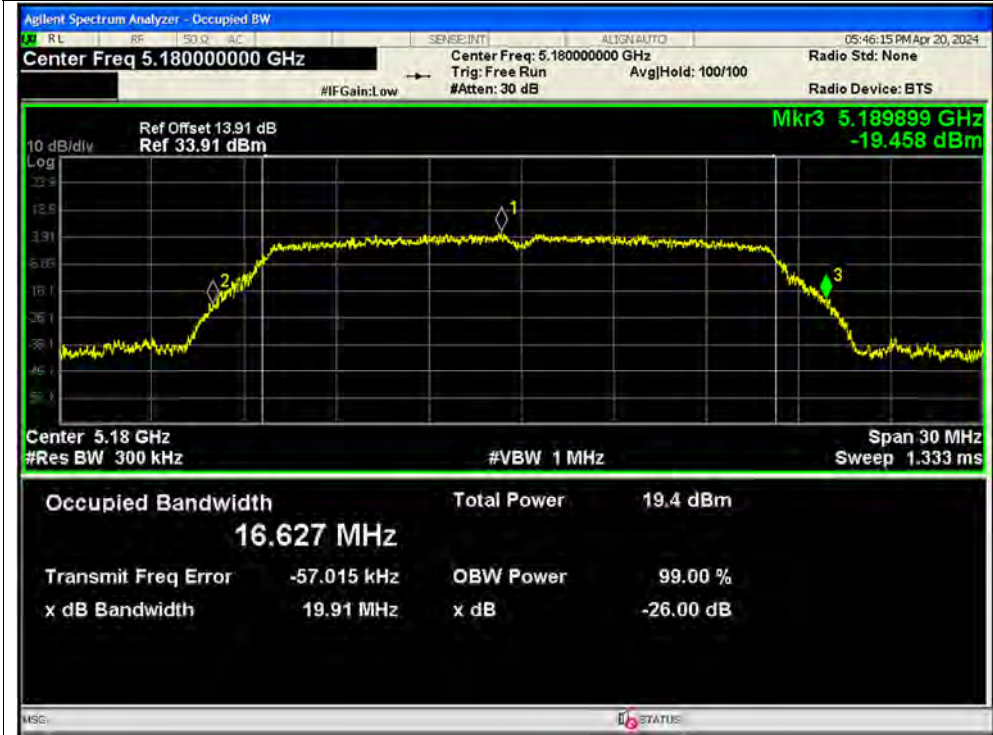

-26dB Bandwidth NVNT a 5220MHz Ant2 SISO





-26dB Bandwidth NVNT a 5240MHz Ant2 SISO



-26dB Bandwidth NVNT a 5260MHz Ant2 SISO





-26dB Bandwidth NVNT a 5300MHz Ant2 SISO



-26dB Bandwidth NVNT a 5320MHz Ant2 SISO





-26dB Bandwidth NVNT a 5500MHz Ant2 SISO



-26dB Bandwidth NVNT a 5580MHz Ant2 SISO





-26dB Bandwidth NVNT a 5600MHz Ant2 SISO



-26dB Bandwidth NVNT a 5720MHz Ant2 SISO





-26dB Bandwidth NVNT n20 5180MHz Ant1 SISO



-26dB Bandwidth NVNT n20 5220MHz Ant1 SISO

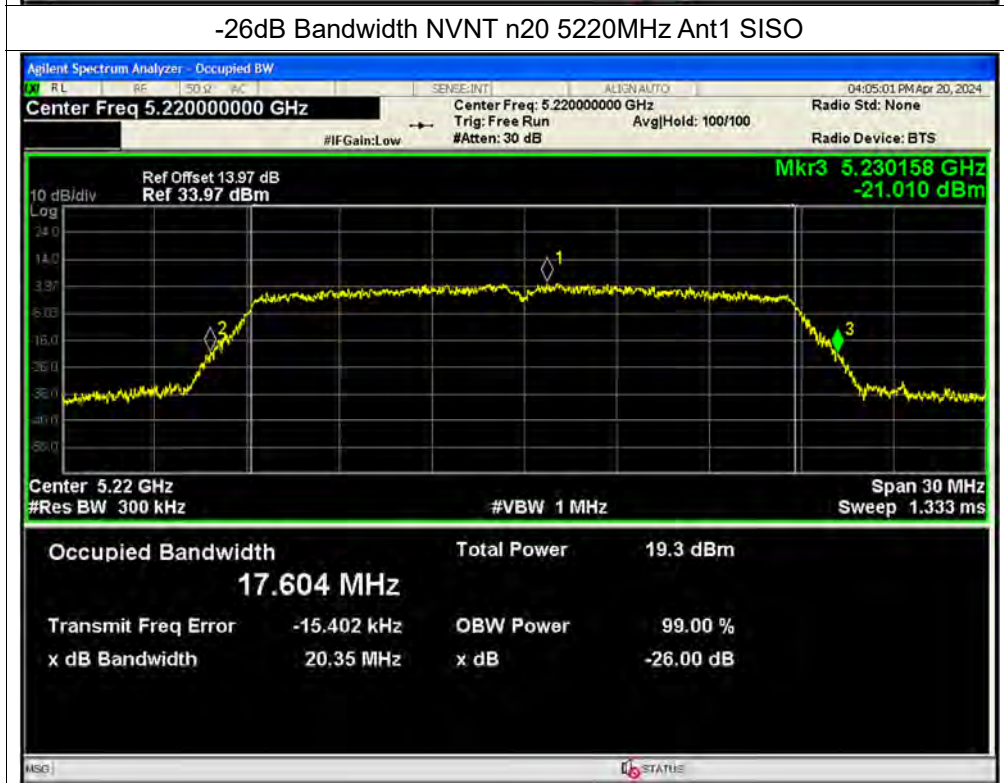



-26dB Bandwidth NVNT n20 5240MHz Ant1 SISO

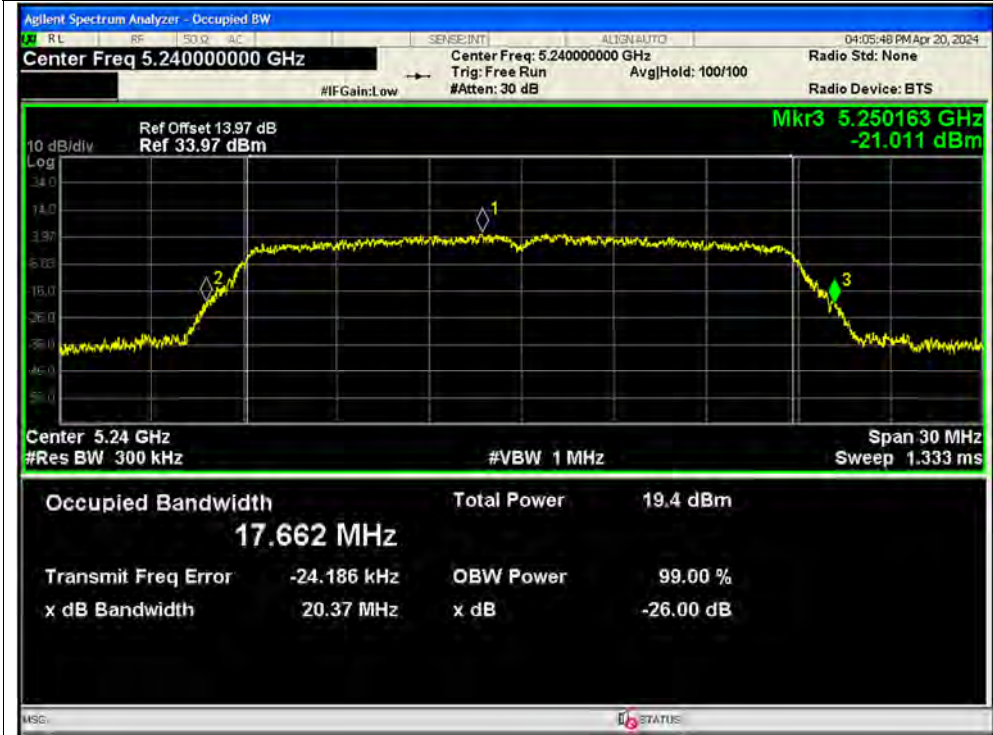

-26dB Bandwidth NVNT n20 5260MHz Ant1 SISO







-26dB Bandwidth NVNT n20 5300MHz Ant1 SISO

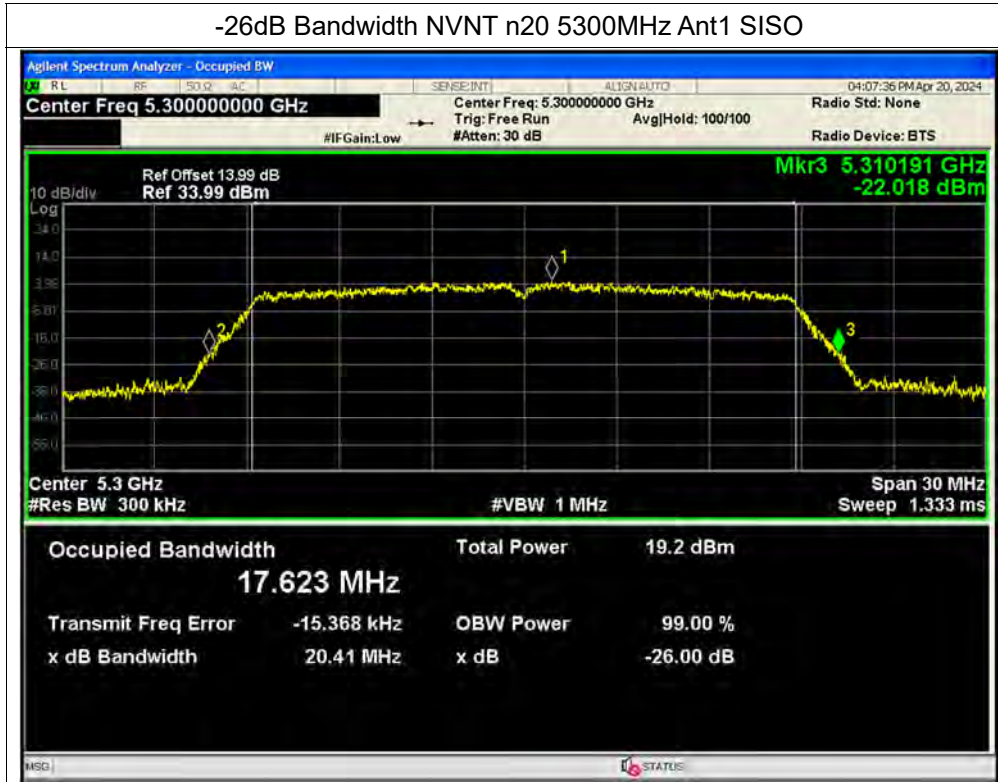

-26dB Bandwidth NVNT n20 5320MHz Ant1 SISO

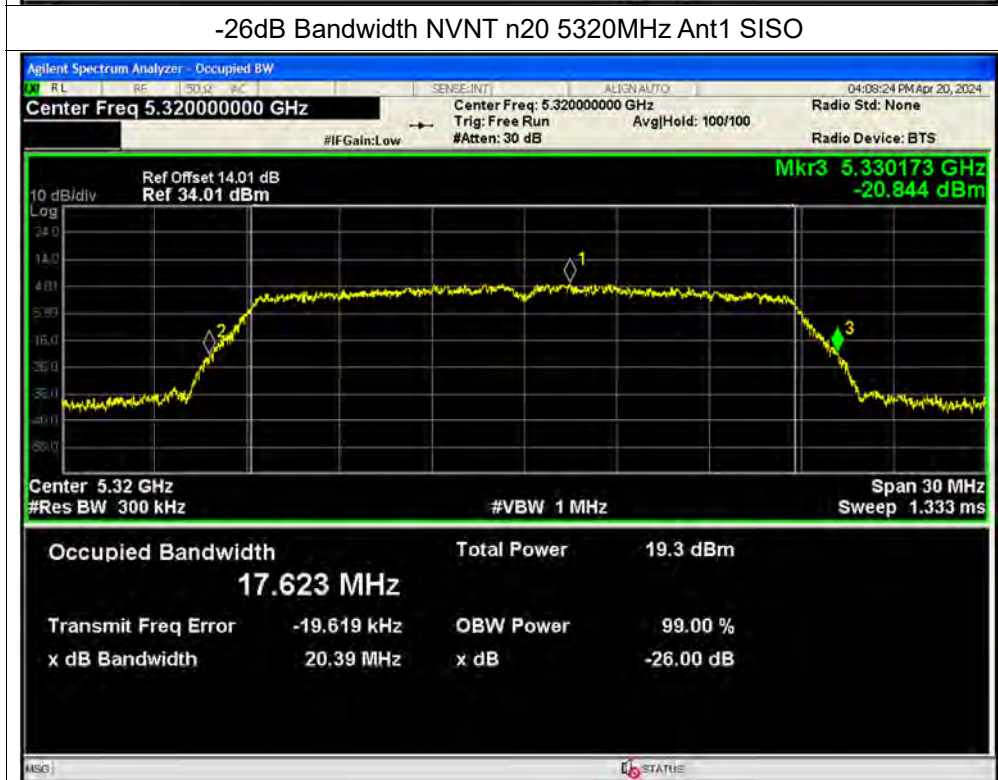



-26dB Bandwidth NVNT n20 5500MHz Ant1 SISO

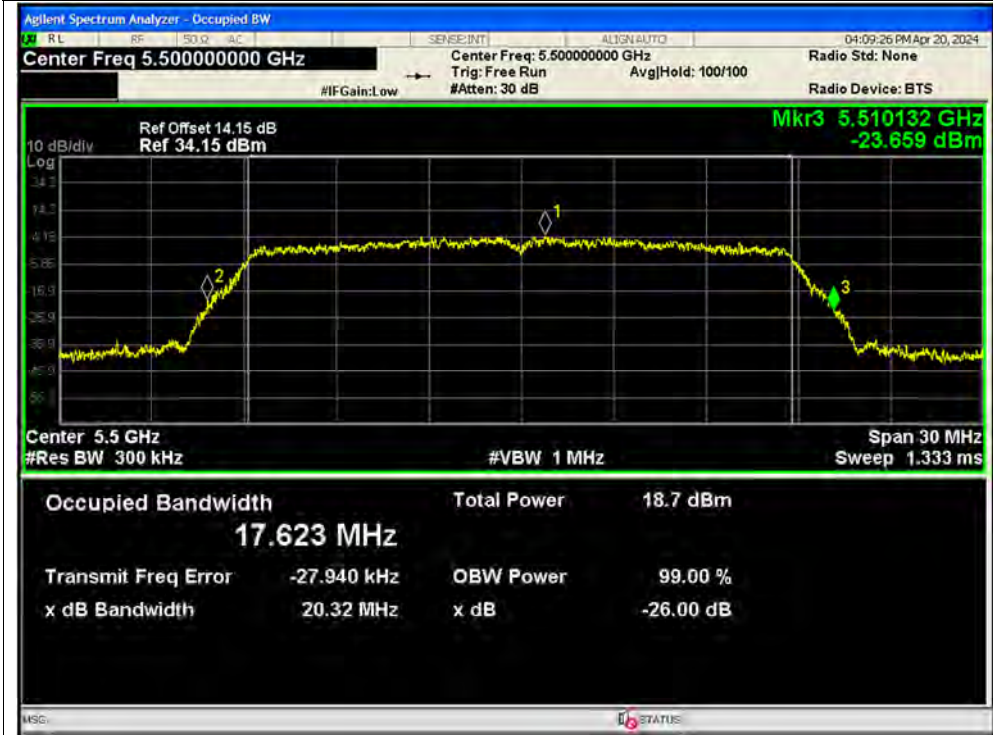

-26dB Bandwidth NVNT n20 5580MHz Ant1 SISO





-26dB Bandwidth NVNT n20 5600MHz Ant1 SISO



-26dB Bandwidth NVNT n20 5720MHz Ant1 SISO





-26dB Bandwidth NVNT n20 5180MHz Ant2 SISO



-26dB Bandwidth NVNT n20 5220MHz Ant2 SISO





-26dB Bandwidth NVNT n20 5240MHz Ant2 SISO



-26dB Bandwidth NVNT n20 5260MHz Ant2 SISO





-26dB Bandwidth NVNT n20 5300MHz Ant2 SISO

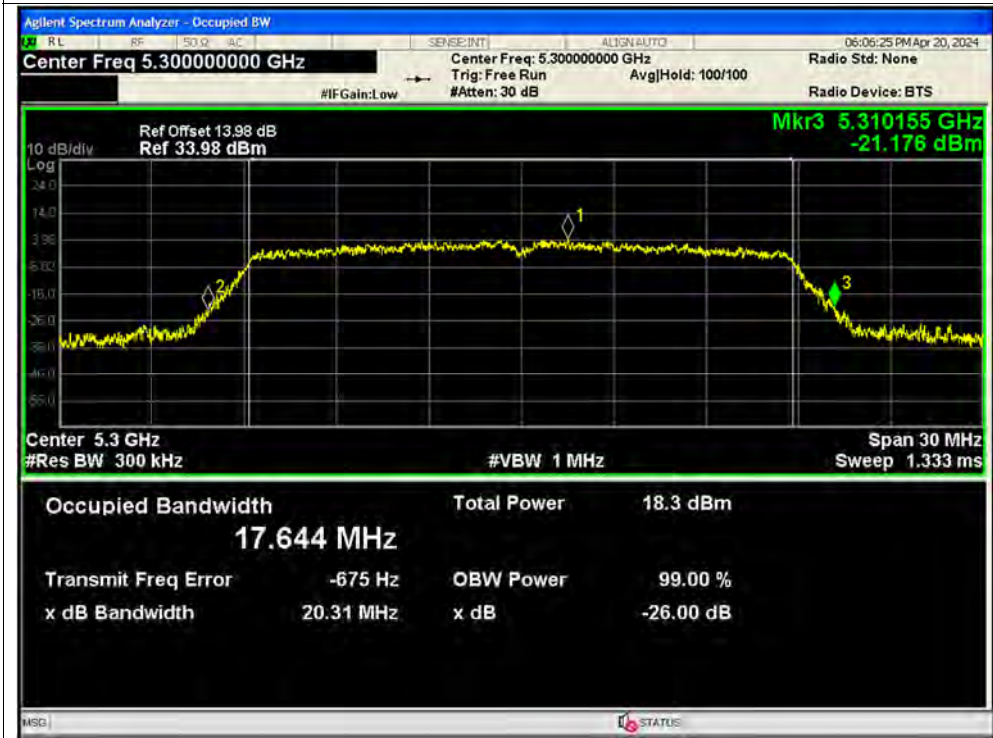

-26dB Bandwidth NVNT n20 5320MHz Ant2 SISO





-26dB Bandwidth NVNT n20 5500MHz Ant2 SISO

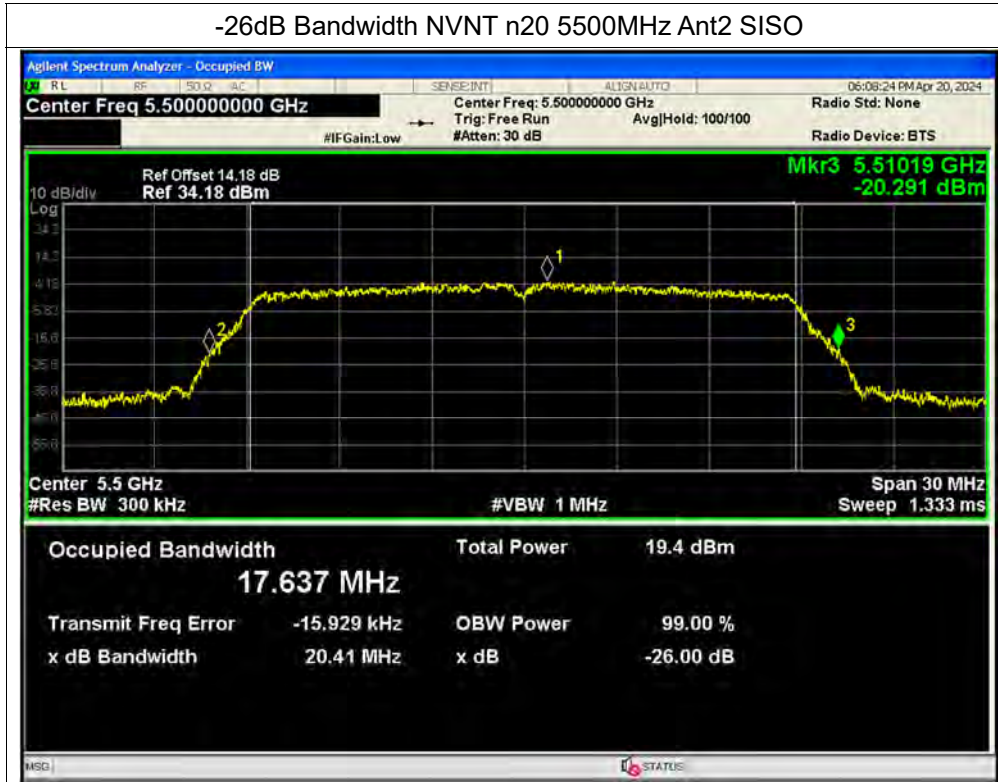

-26dB Bandwidth NVNT n20 5580MHz Ant2 SISO





-26dB Bandwidth NVNT n20 5600MHz Ant2 SISO

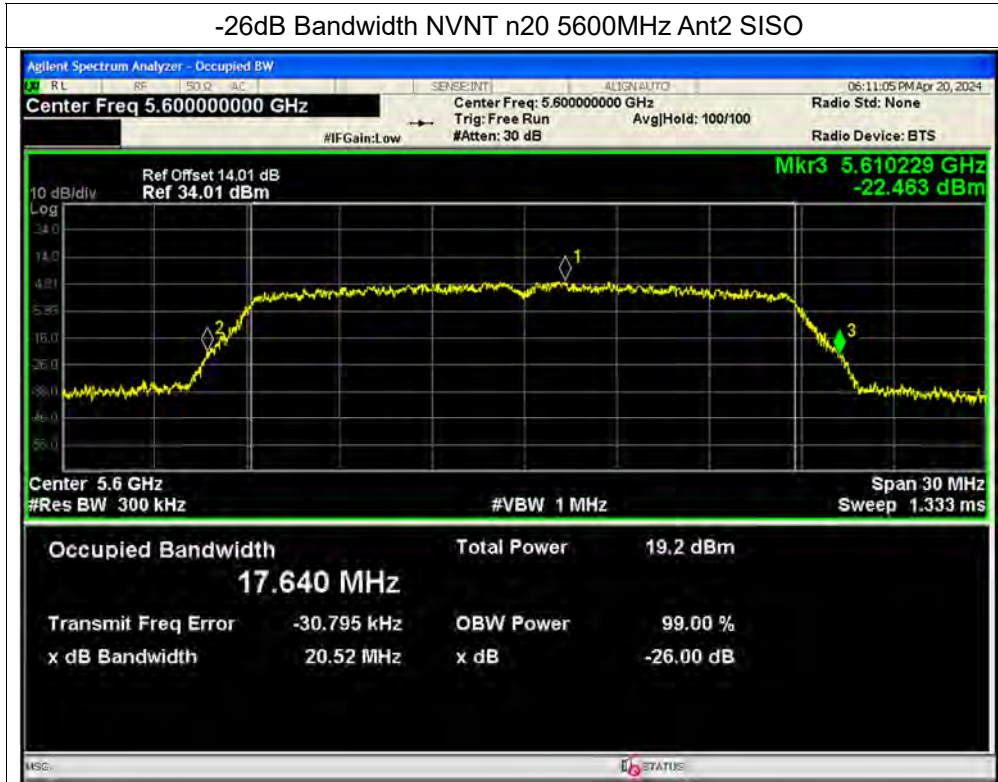

-26dB Bandwidth NVNT n20 5720MHz Ant2 SISO

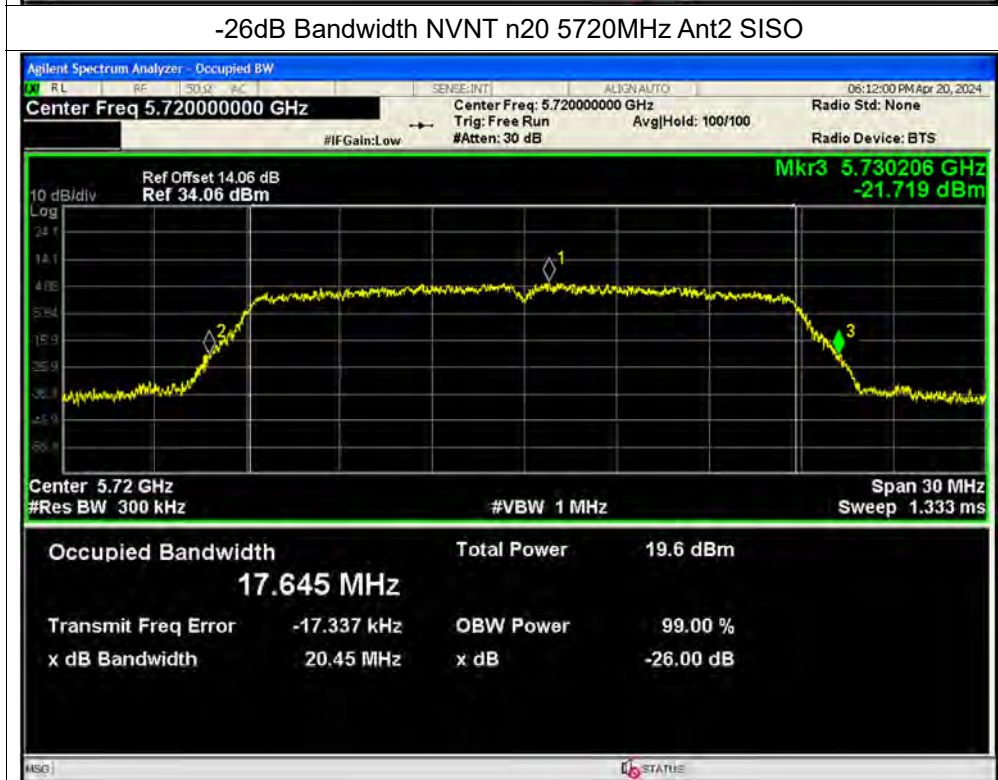





-26dB Bandwidth NVNT n20 5180MHz Ant1 MIMO



-26dB Bandwidth NVNT n20 5180MHz Ant2 MIMO

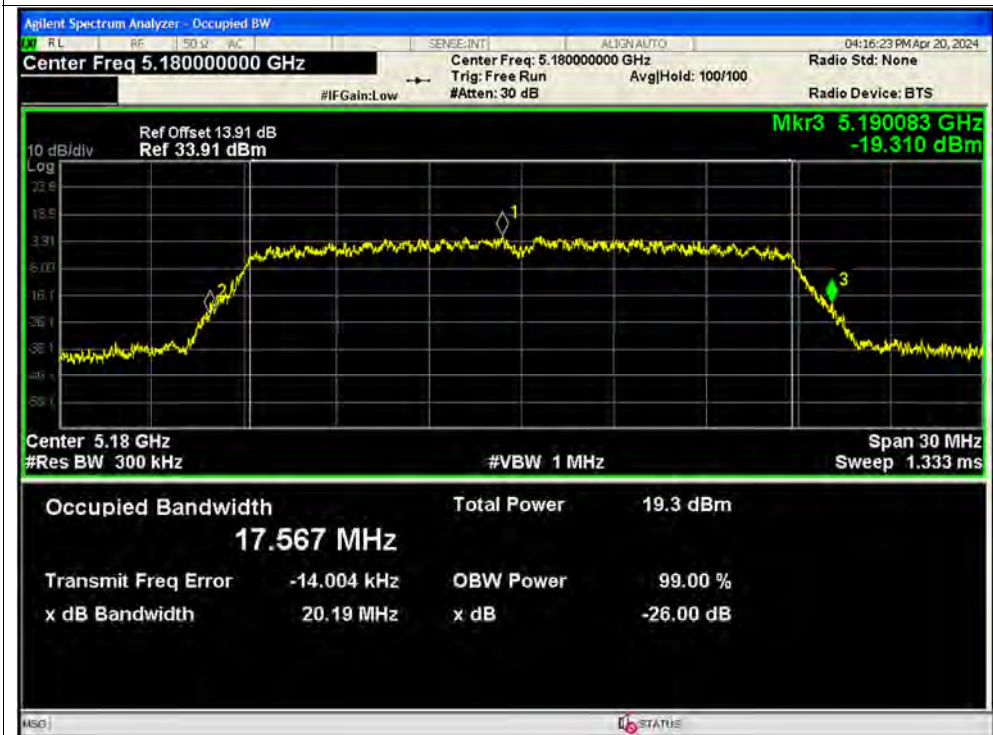



-26dB Bandwidth NVNT n20 5220MHz Ant1 MIMO

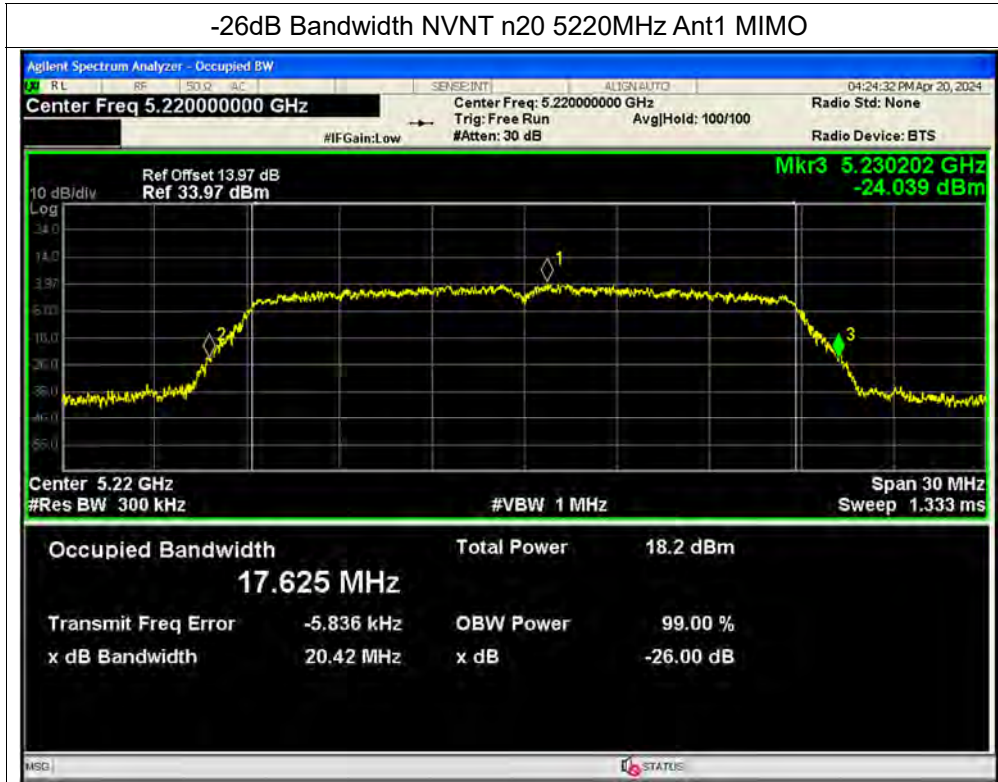

-26dB Bandwidth NVNT n20 5220MHz Ant2 MIMO

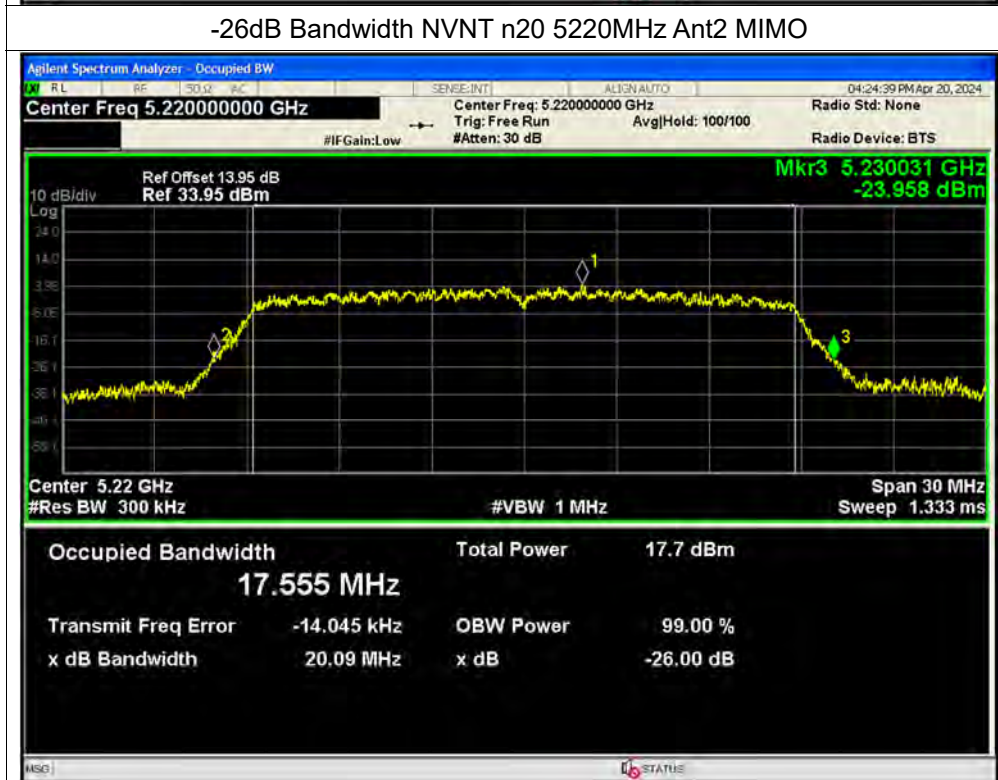



-26dB Bandwidth NVNT n20 5240MHz Ant1 MIMO

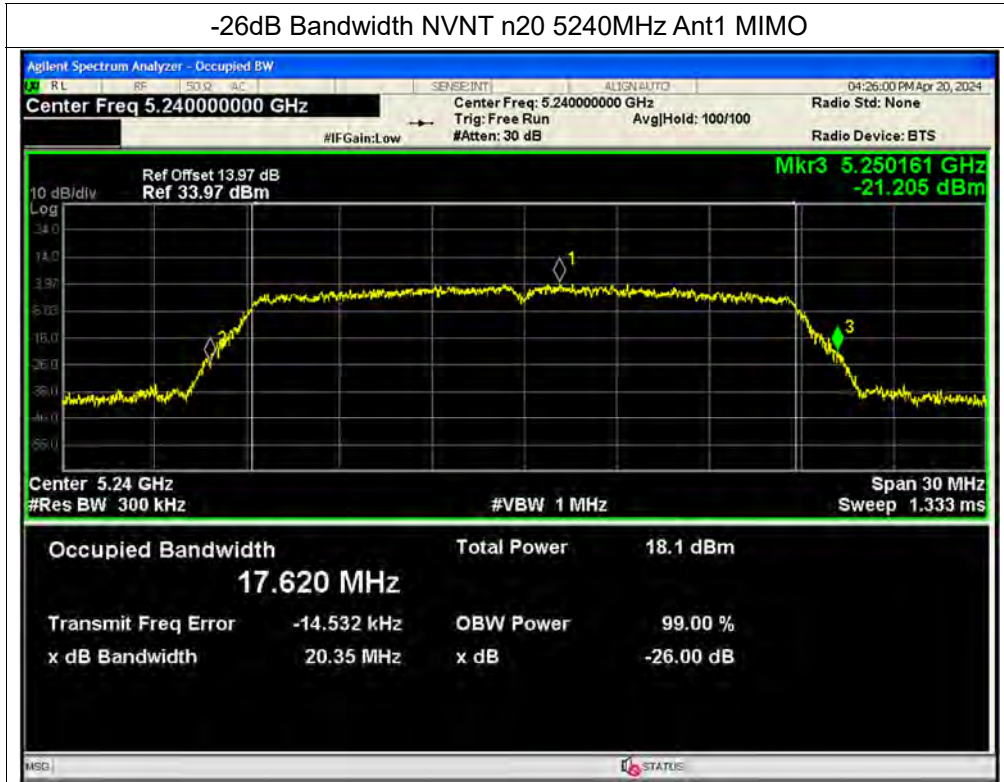

-26dB Bandwidth NVNT n20 5240MHz Ant2 MIMO

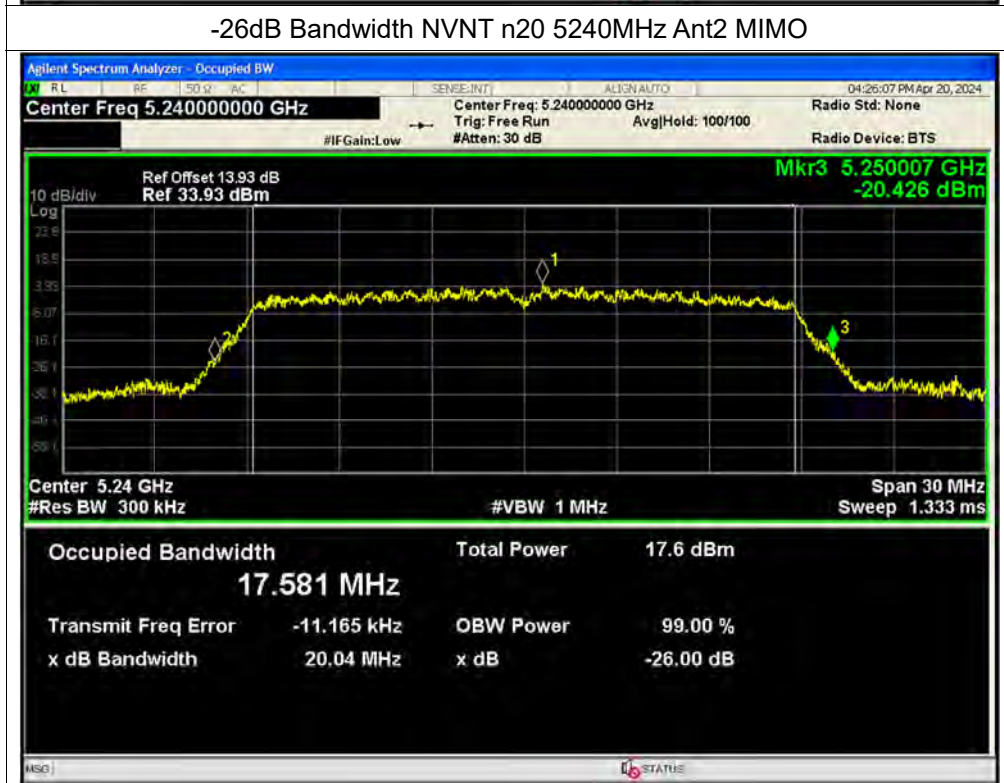



-26dB Bandwidth NVNT n20 5260MHz Ant1 MIMO

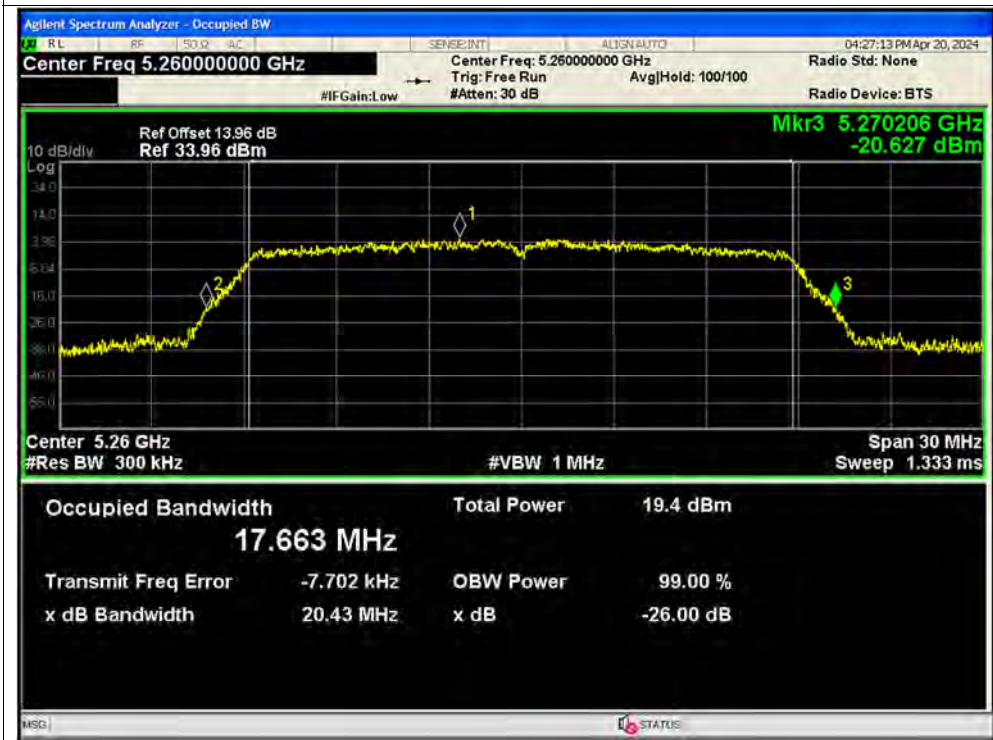

-26dB Bandwidth NVNT n20 5260MHz Ant2 MIMO





-26dB Bandwidth NVNT n20 5300MHz Ant1 MIMO

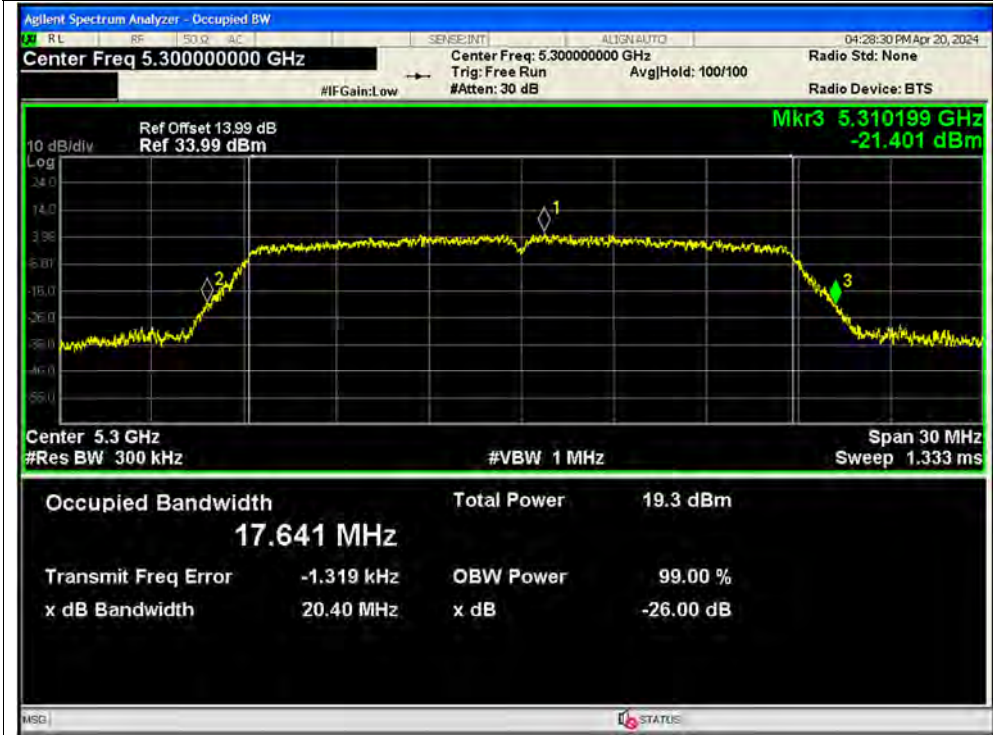

-26dB Bandwidth NVNT n20 5300MHz Ant2 MIMO





-26dB Bandwidth NVNT n20 5320MHz Ant1 MIMO



-26dB Bandwidth NVNT n20 5320MHz Ant2 MIMO





-26dB Bandwidth NVNT n20 5500MHz Ant1 MIMO

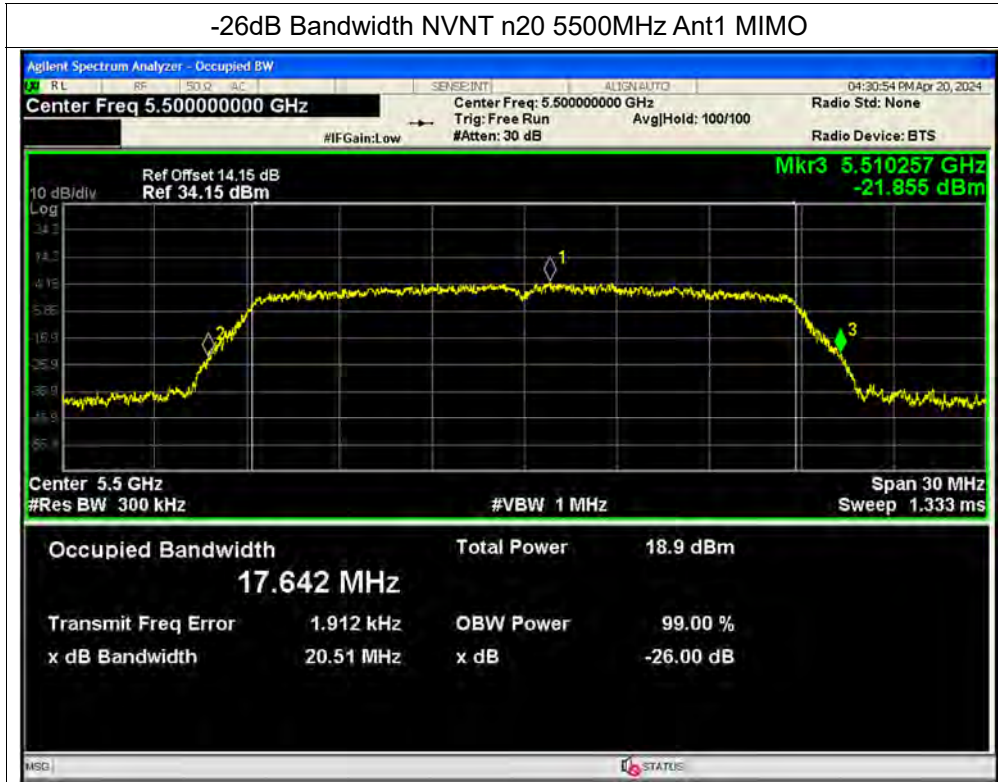

-26dB Bandwidth NVNT n20 5500MHz Ant2 MIMO

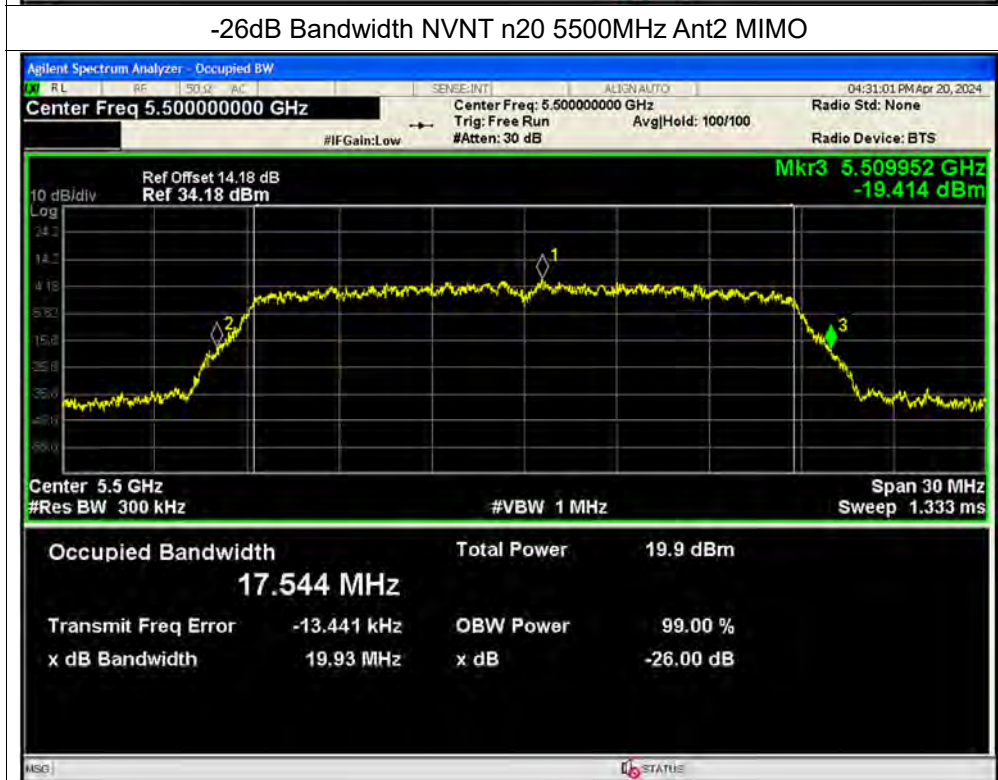



-26dB Bandwidth NVNT n20 5580MHz Ant1 MIMO

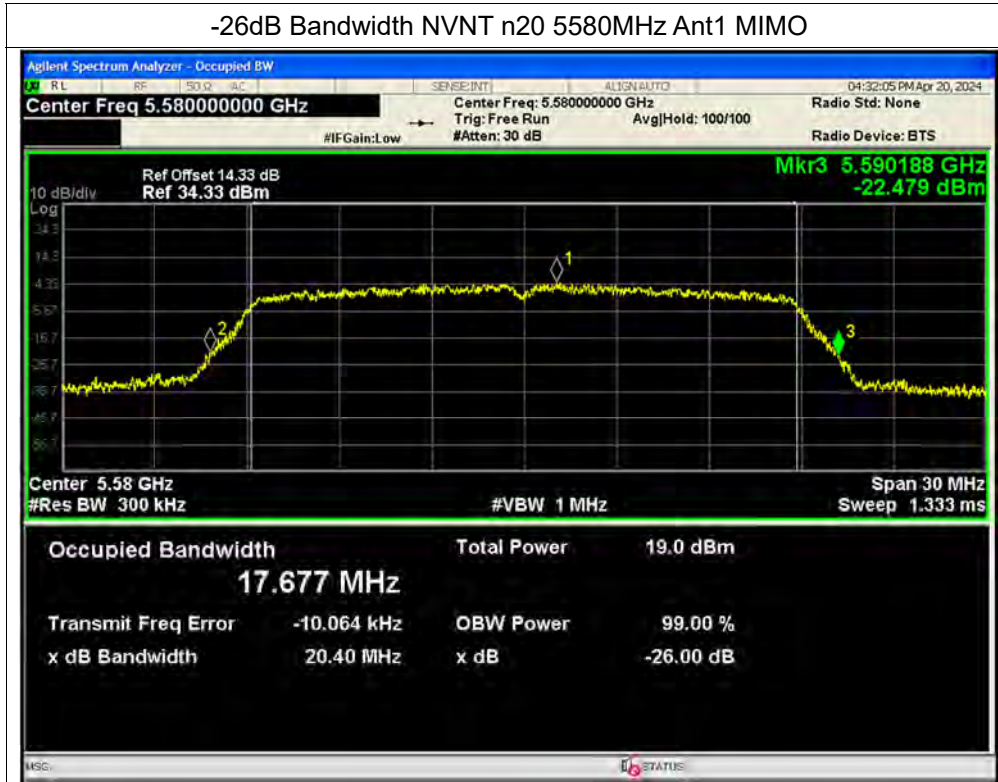

-26dB Bandwidth NVNT n20 5580MHz Ant2 MIMO

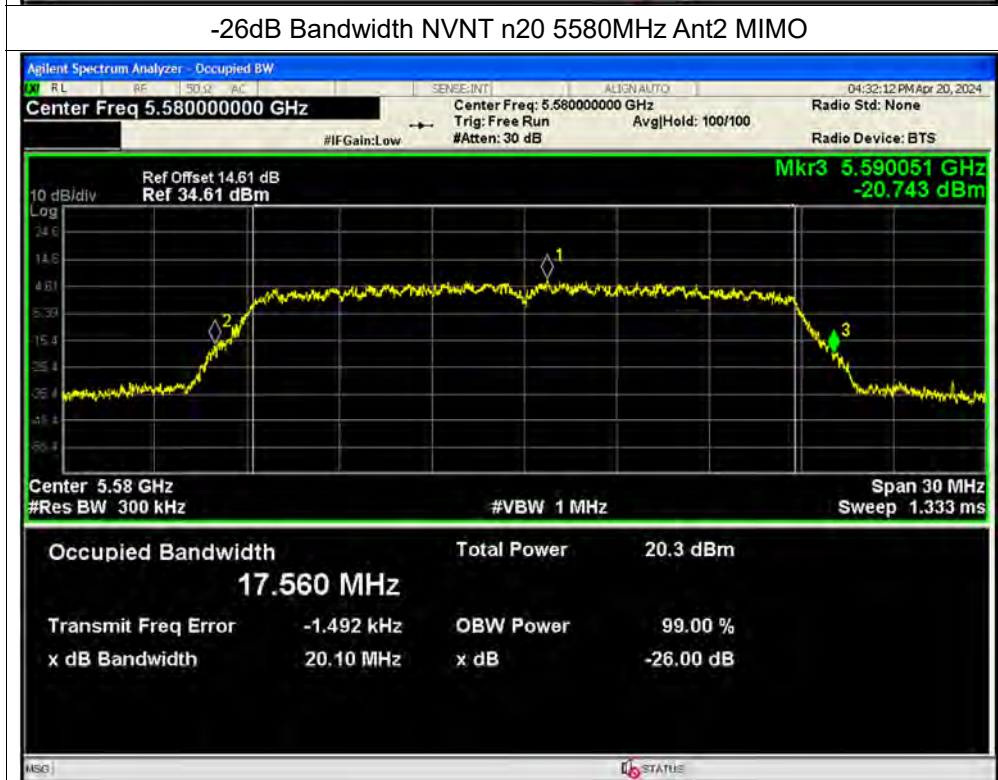





-26dB Bandwidth NVNT n20 5600MHz Ant1 MIMO



-26dB Bandwidth NVNT n20 5600MHz Ant2 MIMO





-26dB Bandwidth NVNT n20 5720MHz Ant1 MIMO

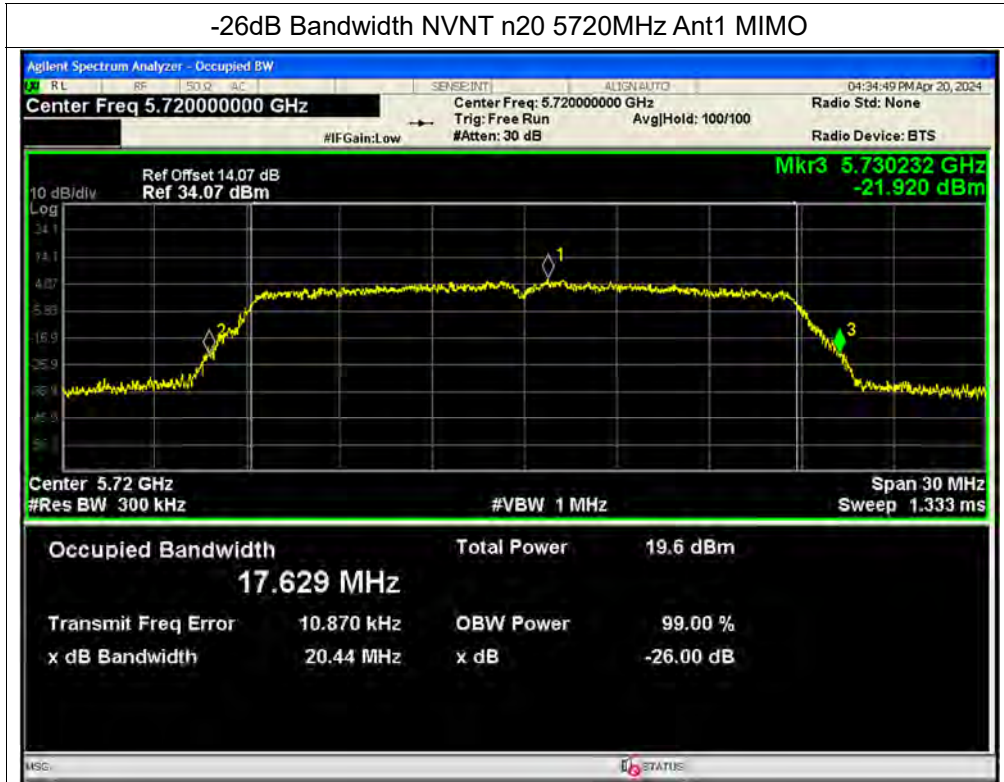

-26dB Bandwidth NVNT n20 5720MHz Ant2 MIMO





-26dB Bandwidth NVNT n40 5190MHz Ant1 SISO



-26dB Bandwidth NVNT n40 5230MHz Ant1 SISO





-26dB Bandwidth NVNT n40 5270MHz Ant1 SISO



-26dB Bandwidth NVNT n40 5310MHz Ant1 SISO





-26dB Bandwidth NVNT n40 5510MHz Ant1 SISO



-26dB Bandwidth NVNT n40 5550MHz Ant1 SISO





-26dB Bandwidth NVNT n40 5630MHz Ant1 SISO



-26dB Bandwidth NVNT n40 5710MHz Ant1 SISO





-26dB Bandwidth NVNT n40 5190MHz Ant2 SISO



-26dB Bandwidth NVNT n40 5230MHz Ant2 SISO





-26dB Bandwidth NVNT n40 5270MHz Ant2 SISO



-26dB Bandwidth NVNT n40 5310MHz Ant2 SISO







-26dB Bandwidth NVNT n40 5510MHz Ant2 SISO



-26dB Bandwidth NVNT n40 5550MHz Ant2 SISO





-26dB Bandwidth NVNT n40 5630MHz Ant2 SISO

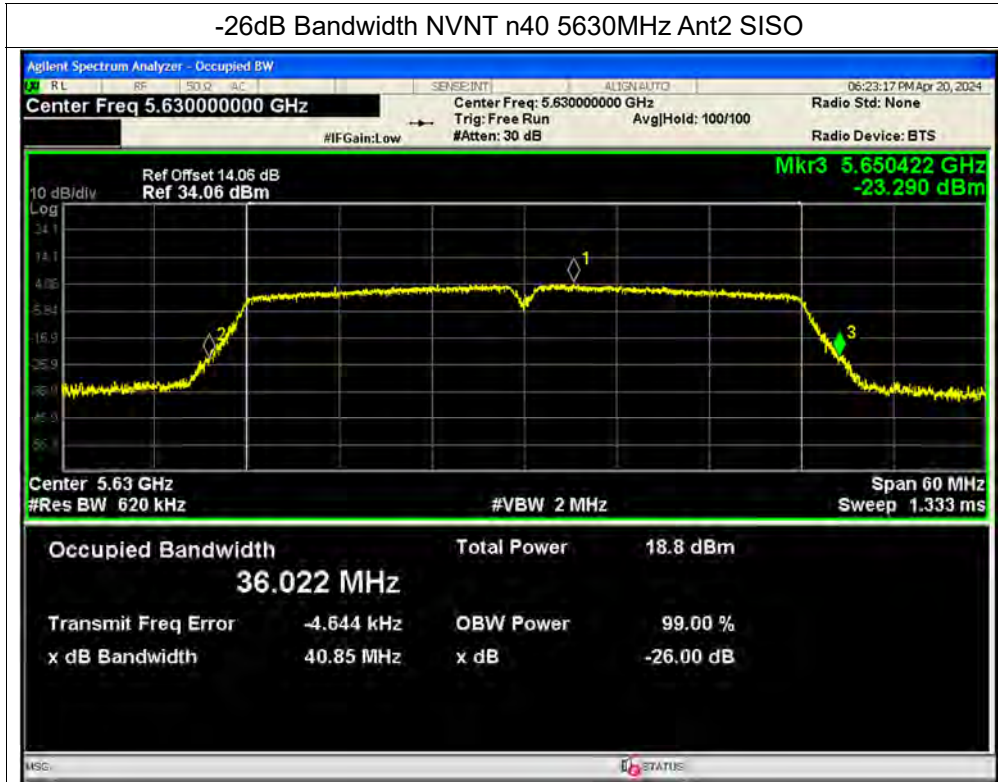

-26dB Bandwidth NVNT n40 5710MHz Ant2 SISO





-26dB Bandwidth NVNT ac20 5180MHz Ant1 SISO



-26dB Bandwidth NVNT ac20 5220MHz Ant1 SISO





-26dB Bandwidth NVNT ac20 5240MHz Ant1 SISO

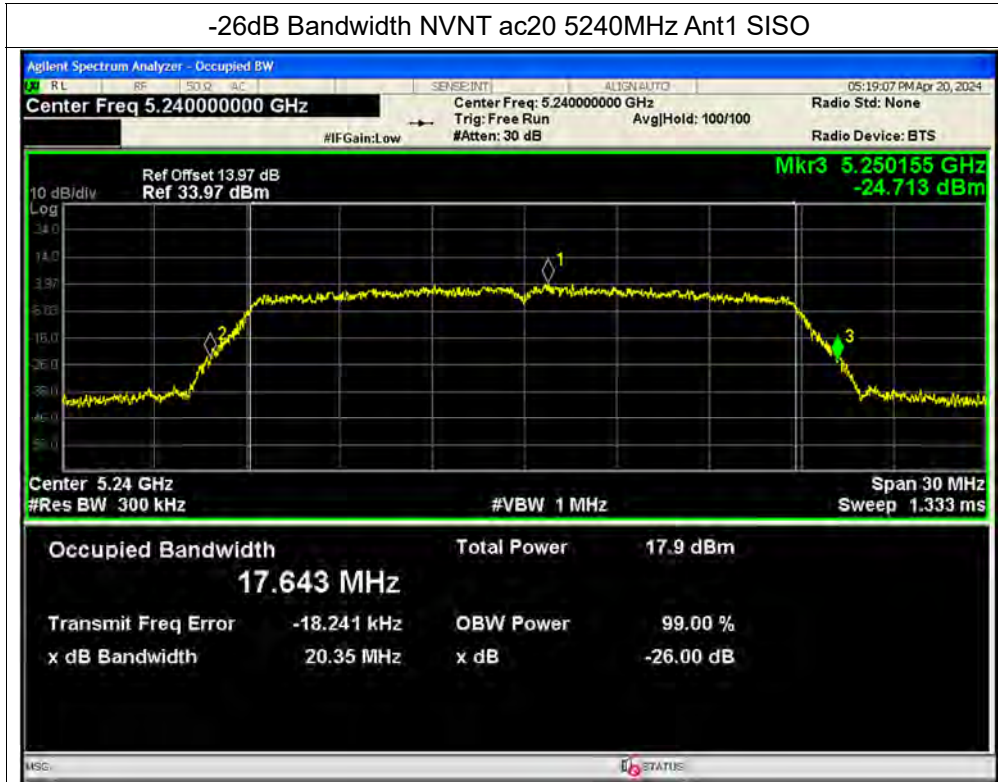

-26dB Bandwidth NVNT ac20 5260MHz Ant1 SISO





-26dB Bandwidth NVNT ac20 5300MHz Ant1 SISO



-26dB Bandwidth NVNT ac20 5320MHz Ant1 SISO





-26dB Bandwidth NVNT ac20 5500MHz Ant1 SISO

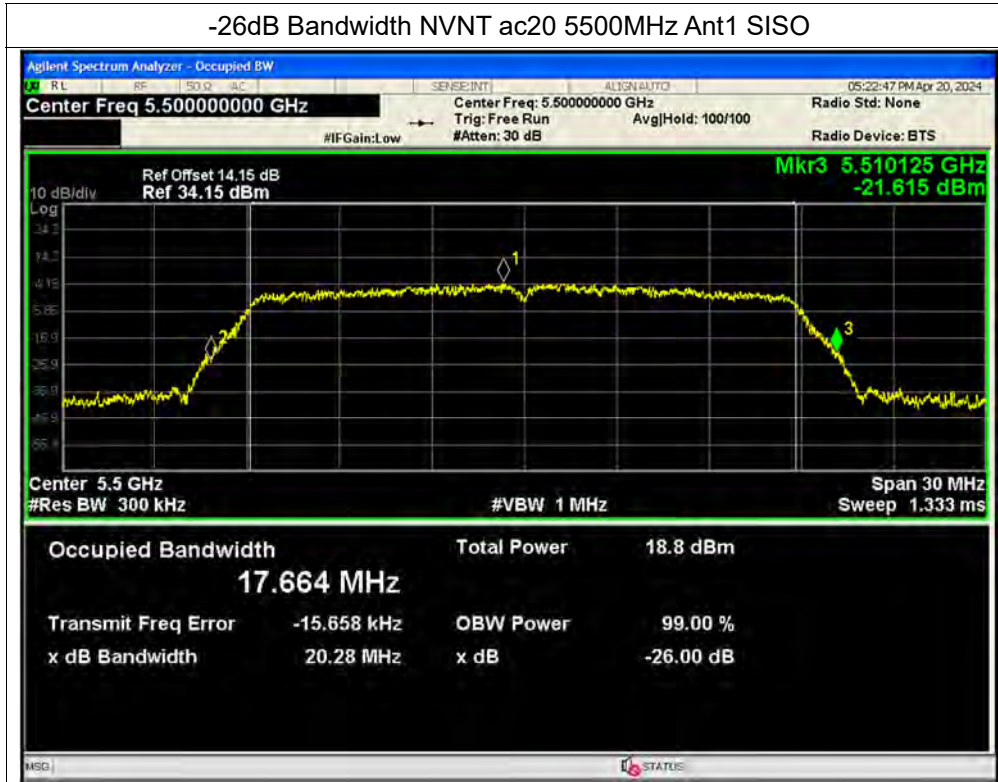

-26dB Bandwidth NVNT ac20 5580MHz Ant1 SISO

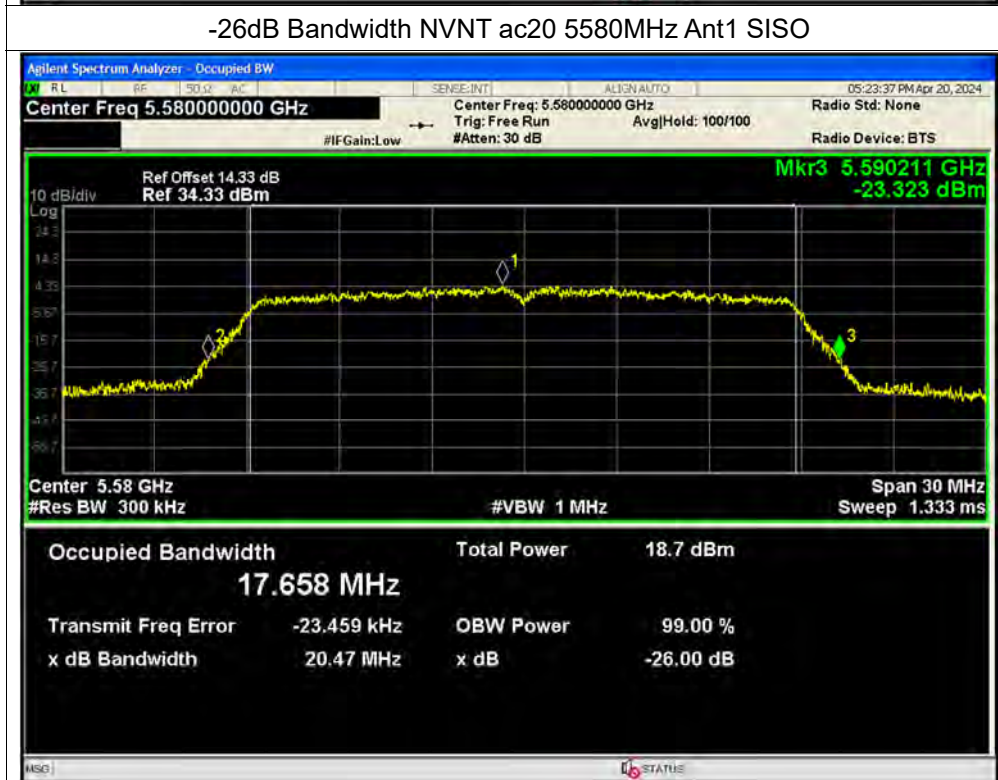



-26dB Bandwidth NVNT ac20 5600MHz Ant1 SISO



-26dB Bandwidth NVNT ac20 5720MHz Ant1 SISO

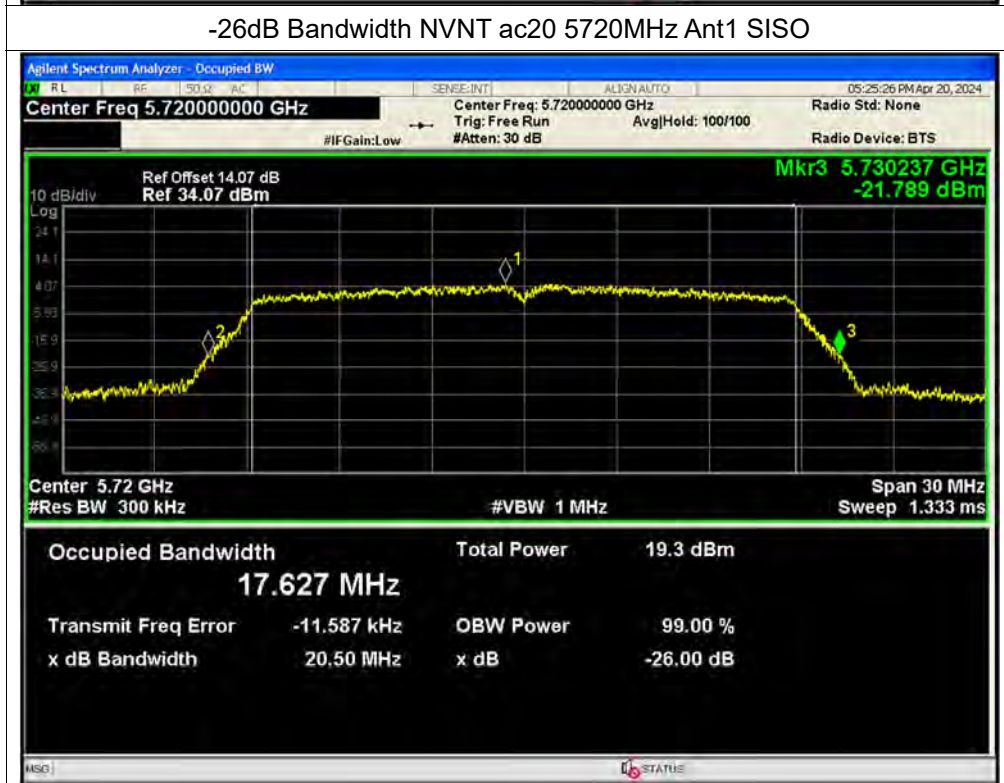



-26dB Bandwidth NVNT ac20 5180MHz Ant2 SISO



-26dB Bandwidth NVNT ac20 5220MHz Ant2 SISO







-26dB Bandwidth NVNT ac20 5240MHz Ant2 SISO

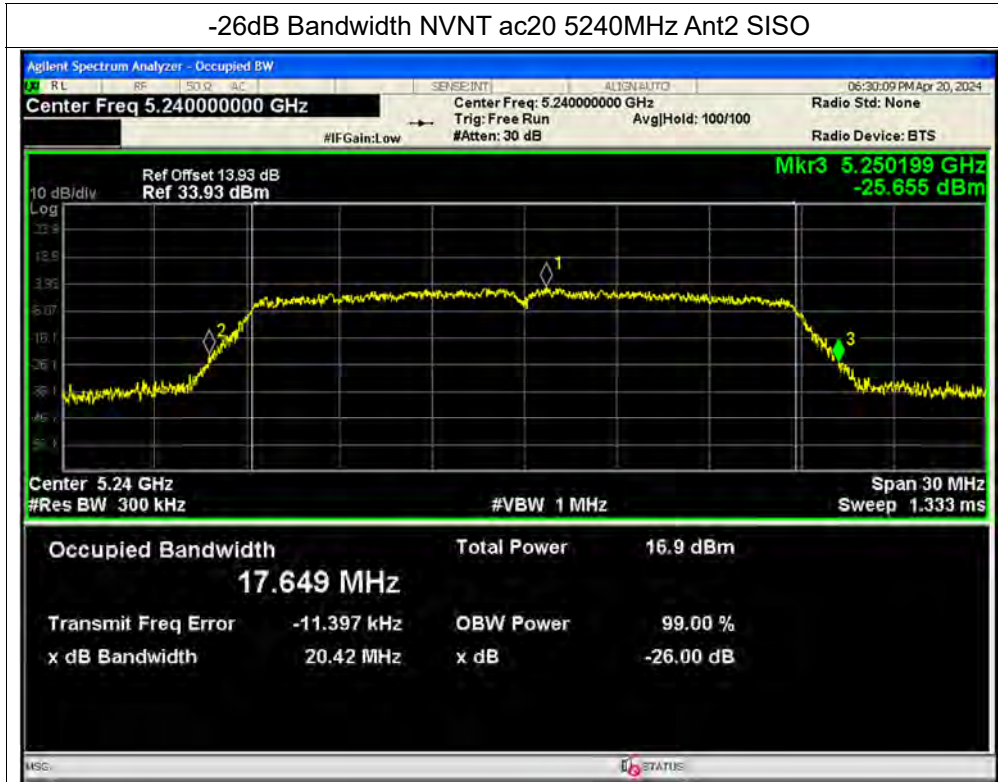

-26dB Bandwidth NVNT ac20 5260MHz Ant2 SISO

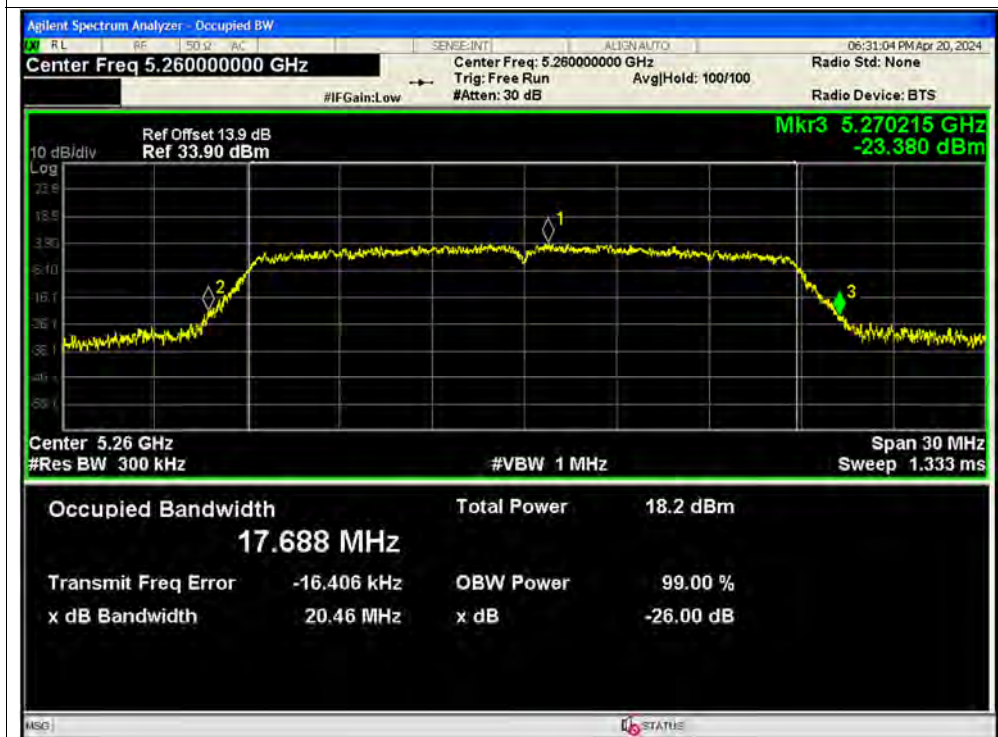



-26dB Bandwidth NVNT ac20 5300MHz Ant2 SISO



-26dB Bandwidth NVNT ac20 5320MHz Ant2 SISO





-26dB Bandwidth NVNT ac20 5500MHz Ant2 SISO

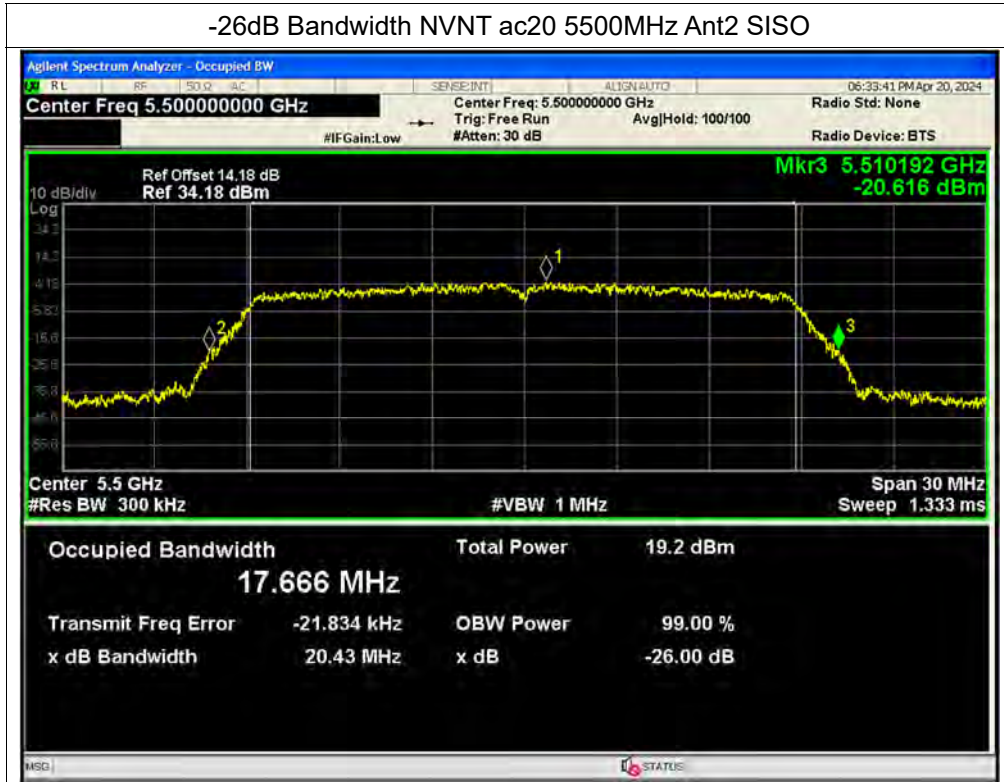

-26dB Bandwidth NVNT ac20 5580MHz Ant2 SISO





-26dB Bandwidth NVNT ac20 5600MHz Ant2 SISO

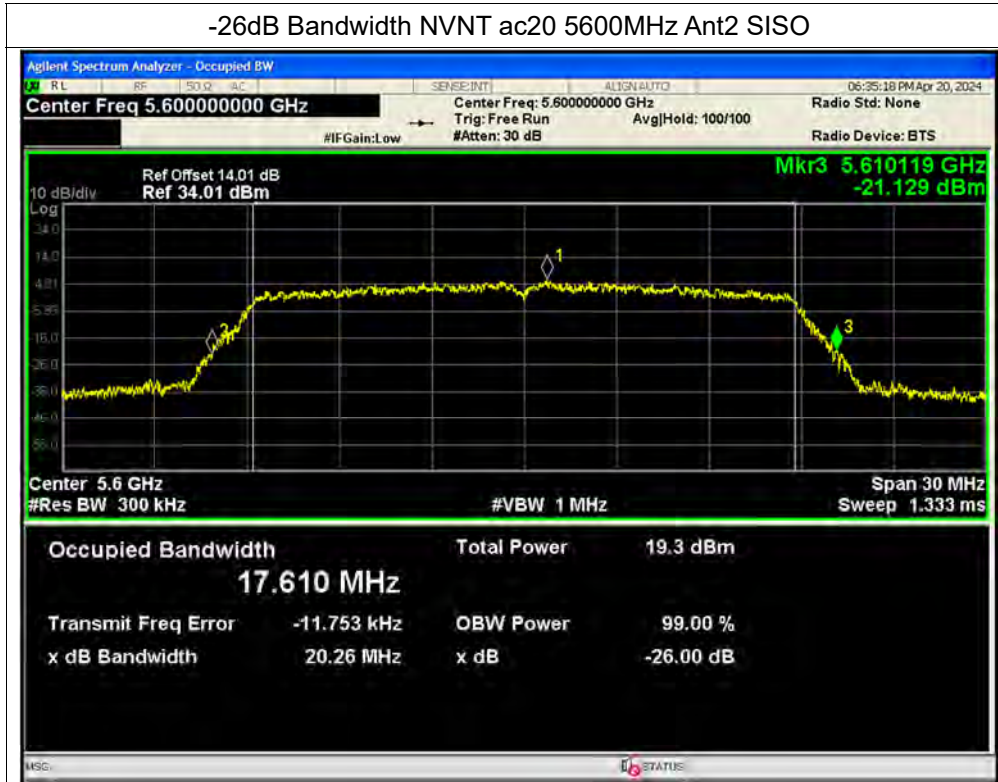

-26dB Bandwidth NVNT ac20 5720MHz Ant2 SISO





-26dB Bandwidth NVNT ac20 5180MHz Ant1 MIMO



-26dB Bandwidth NVNT ac20 5180MHz Ant2 MIMO





-26dB Bandwidth NVNT ac20 5220MHz Ant1 MIMO



-26dB Bandwidth NVNT ac20 5220MHz Ant2 MIMO





-26dB Bandwidth NVNT ac20 5240MHz Ant1 MIMO



-26dB Bandwidth NVNT ac20 5240MHz Ant2 MIMO





-26dB Bandwidth NVNT ac20 5260MHz Ant1 MIMO



-26dB Bandwidth NVNT ac20 5260MHz Ant2 MIMO







-26dB Bandwidth NVNT ac20 5300MHz Ant1 MIMO



-26dB Bandwidth NVNT ac20 5300MHz Ant2 MIMO





-26dB Bandwidth NVNT ac20 5320MHz Ant1 MIMO



-26dB Bandwidth NVNT ac20 5320MHz Ant2 MIMO





-26dB Bandwidth NVNT ac20 5500MHz Ant1 MIMO



-26dB Bandwidth NVNT ac20 5500MHz Ant2 MIMO





-26dB Bandwidth NVNT ac20 5580MHz Ant1 MIMO



-26dB Bandwidth NVNT ac20 5580MHz Ant2 MIMO





-26dB Bandwidth NVNT ac20 5600MHz Ant1 MIMO



-26dB Bandwidth NVNT ac20 5600MHz Ant2 MIMO





-26dB Bandwidth NVNT ac20 5720MHz Ant1 MIMO



-26dB Bandwidth NVNT ac20 5720MHz Ant2 MIMO





-26dB Bandwidth NVNT ac40 5190MHz Ant1 SISO



-26dB Bandwidth NVNT ac40 5230MHz Ant1 SISO





-26dB Bandwidth NVNT ac40 5270MHz Ant1 SISO

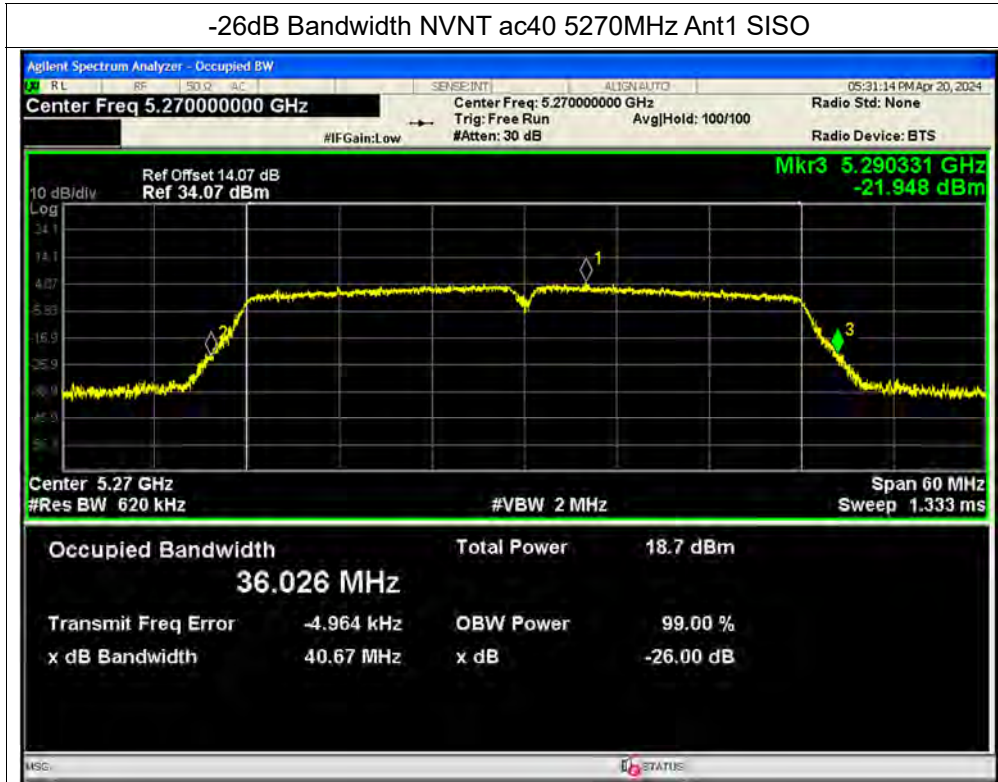

-26dB Bandwidth NVNT ac40 5310MHz Ant1 SISO







-26dB Bandwidth NVNT ac40 5510MHz Ant1 SISO



-26dB Bandwidth NVNT ac40 5550MHz Ant1 SISO





-26dB Bandwidth NVNT ac40 5630MHz Ant1 SISO



-26dB Bandwidth NVNT ac40 5710MHz Ant1 SISO





-26dB Bandwidth NVNT ac40 5190MHz Ant2 SISO

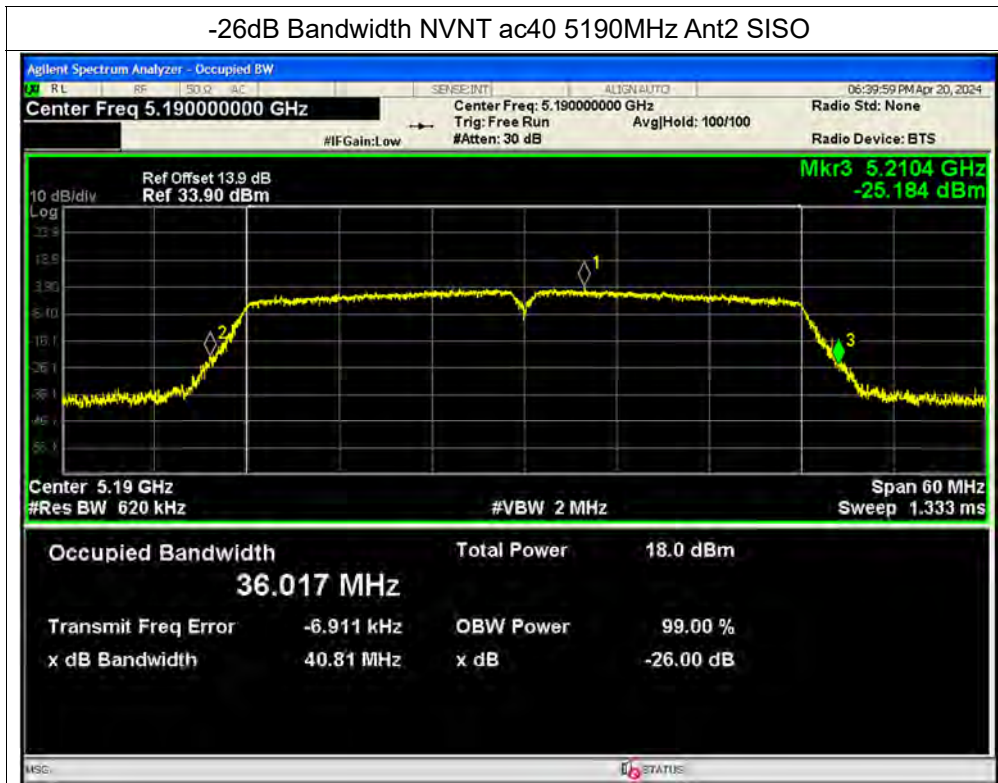

-26dB Bandwidth NVNT ac40 5230MHz Ant2 SISO





-26dB Bandwidth NVNT ac40 5270MHz Ant2 SISO

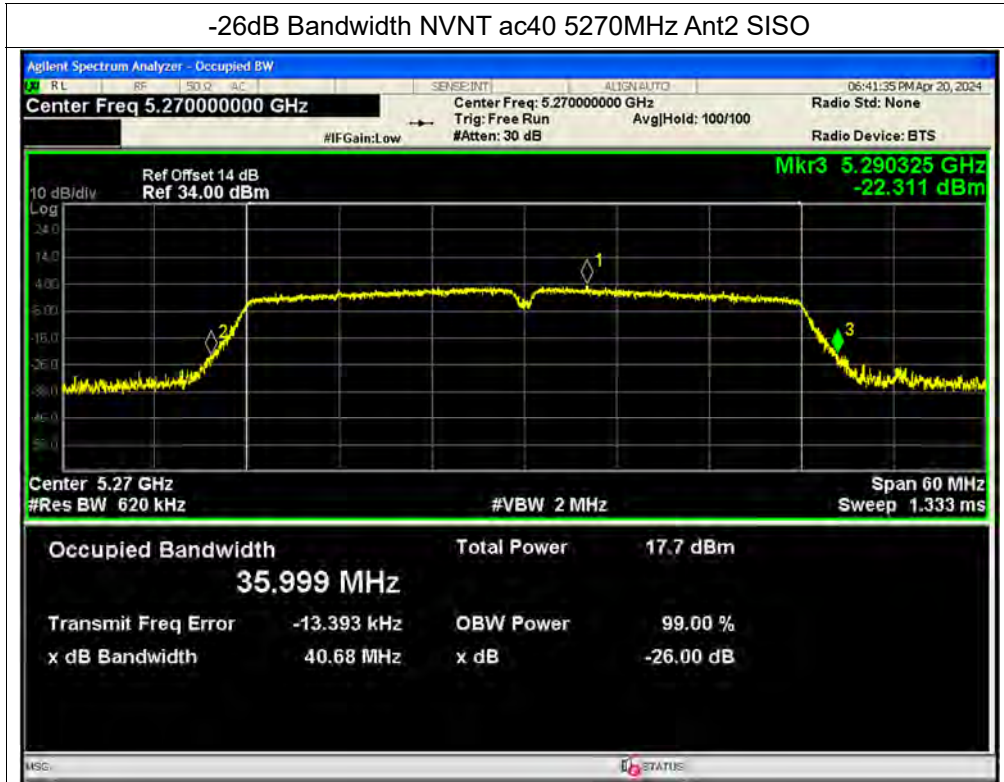

-26dB Bandwidth NVNT ac40 5310MHz Ant2 SISO





-26dB Bandwidth NVNT ac40 5510MHz Ant2 SISO



-26dB Bandwidth NVNT ac40 5550MHz Ant2 SISO





-26dB Bandwidth NVNT ac40 5630MHz Ant2 SISO



-26dB Bandwidth NVNT ac40 5710MHz Ant2 SISO

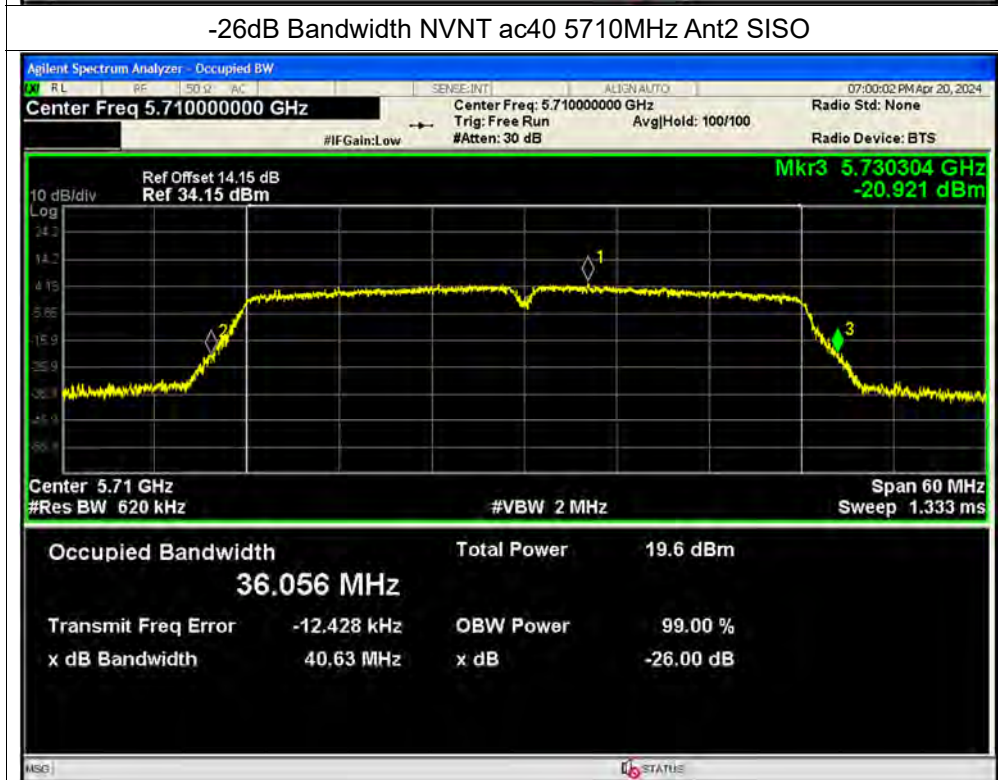



-26dB Bandwidth NVNT ac80 5210MHz Ant1 SISO

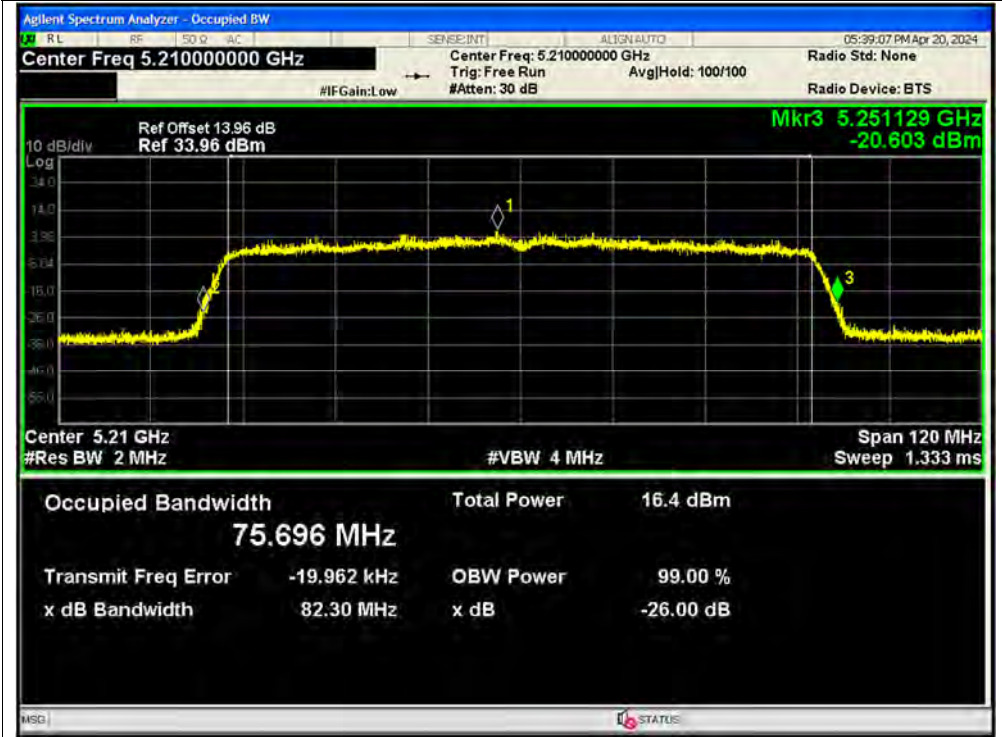

-26dB Bandwidth NVNT ac80 5290MHz Ant1 SISO

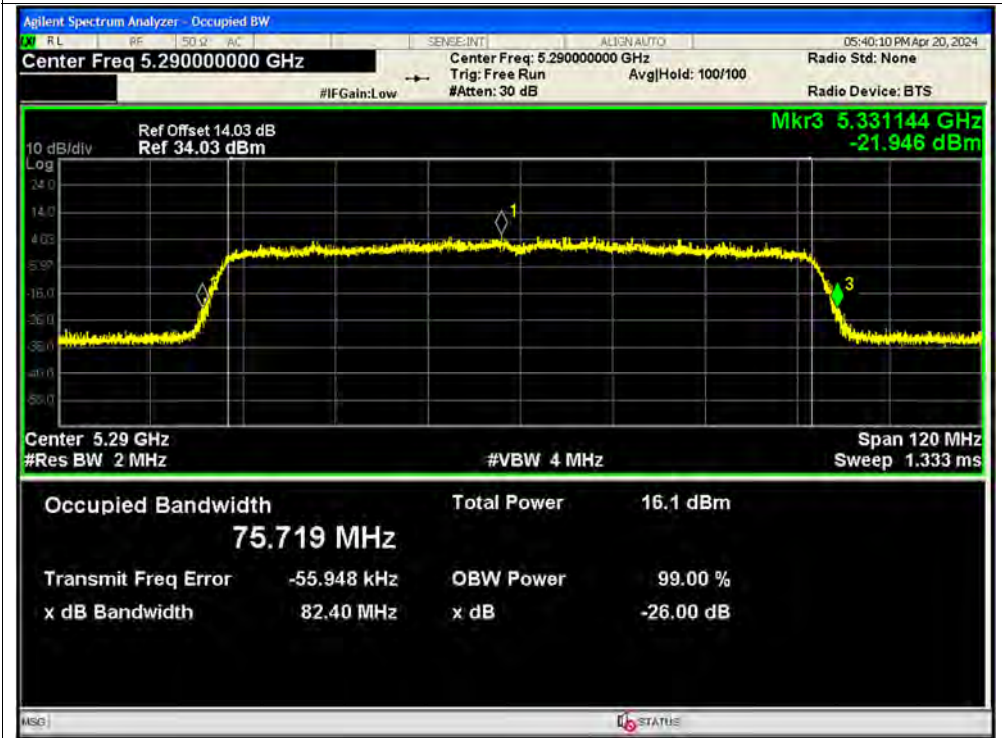



-26dB Bandwidth NVNT ac80 5530MHz Ant1 SISO

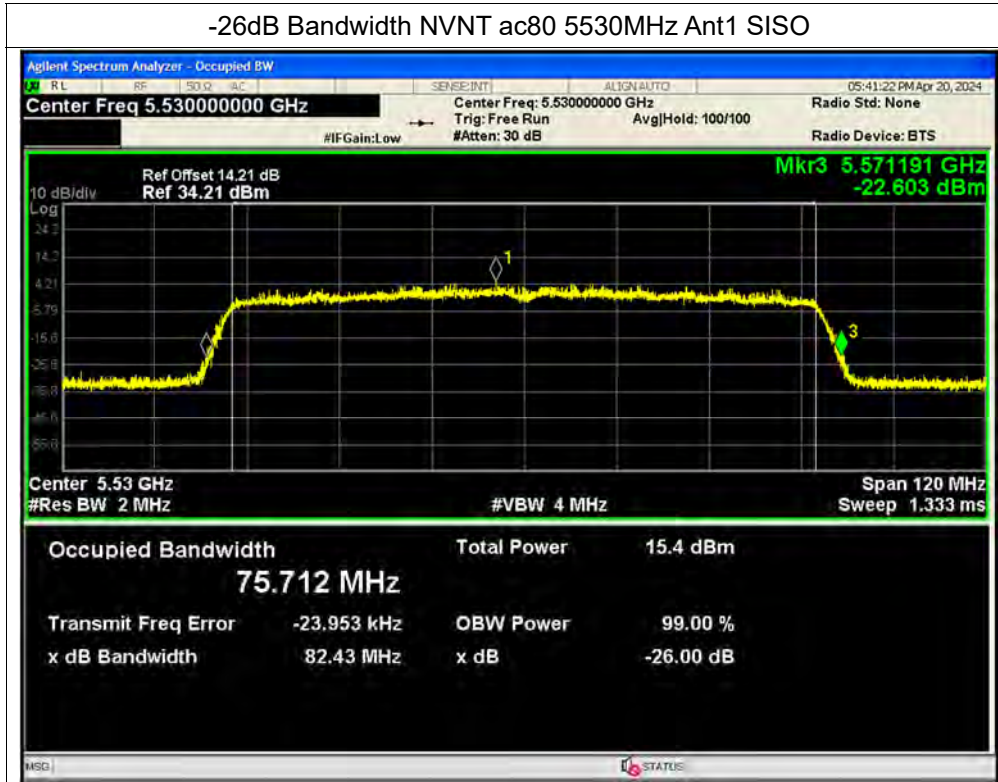

-26dB Bandwidth NVNT ac80 5610MHz Ant1 SISO

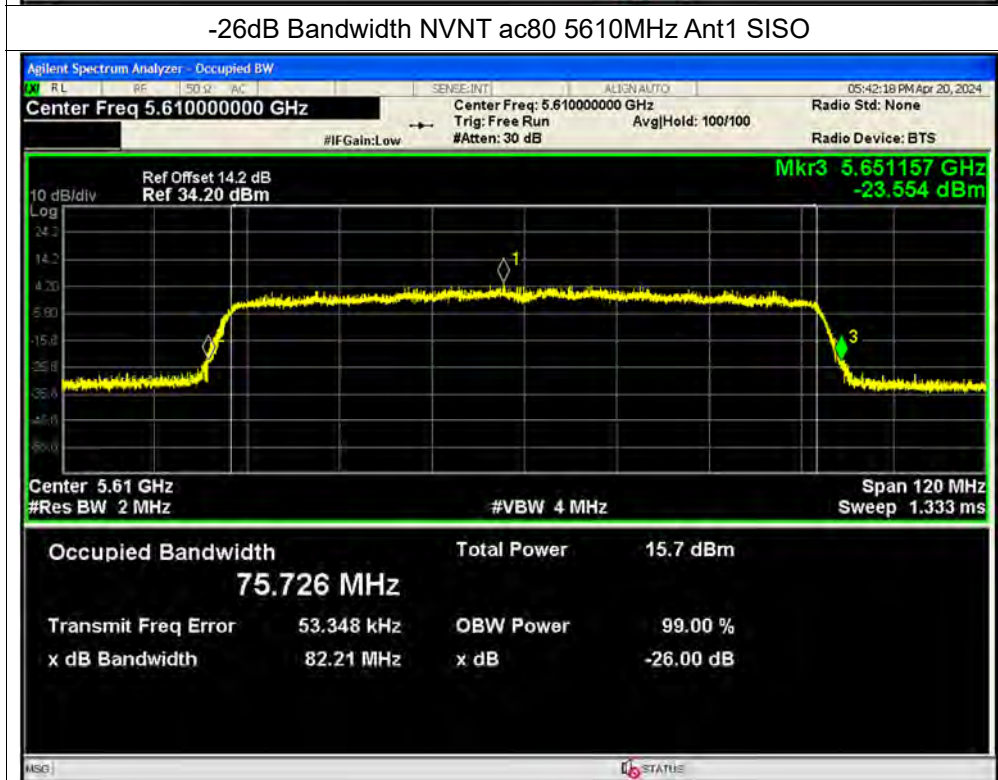





-26dB Bandwidth NVNT ac80 5690MHz Ant1 SISO

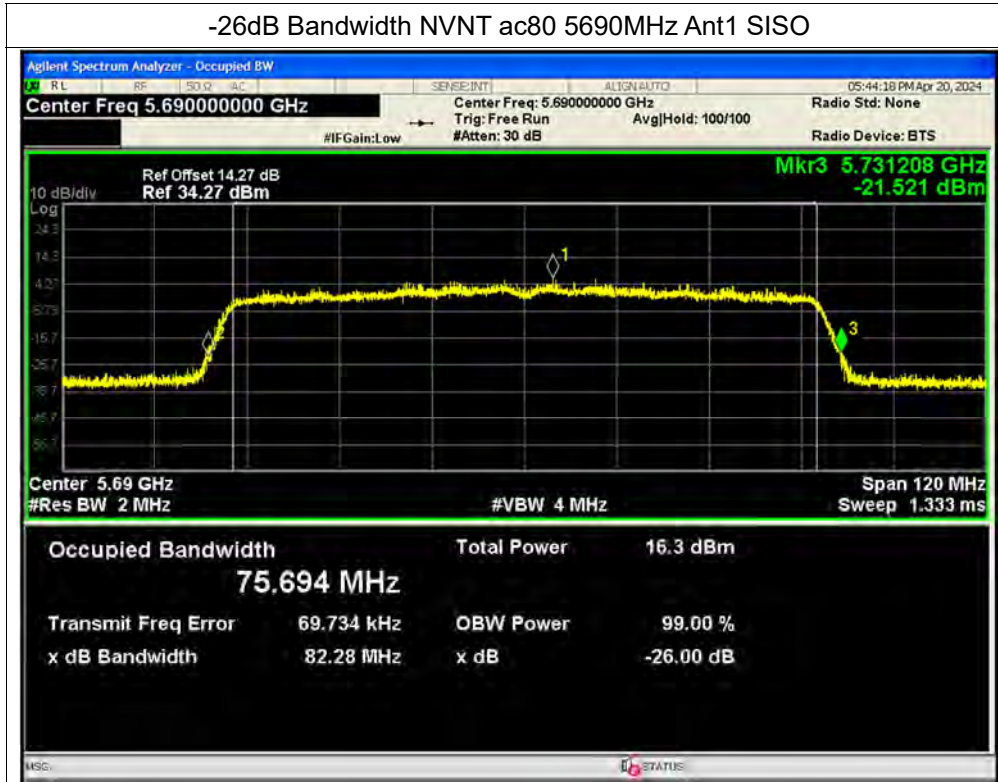

-26dB Bandwidth NVNT ac80 5210MHz Ant2 SISO

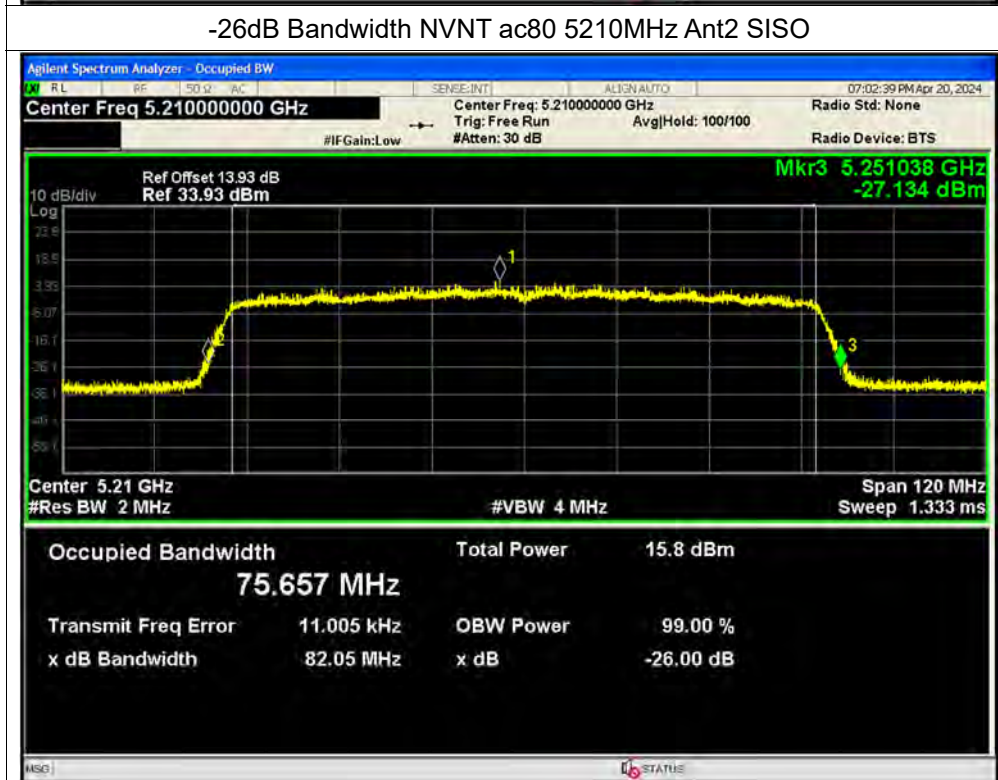



-26dB Bandwidth NVNT ac80 5290MHz Ant2 SISO

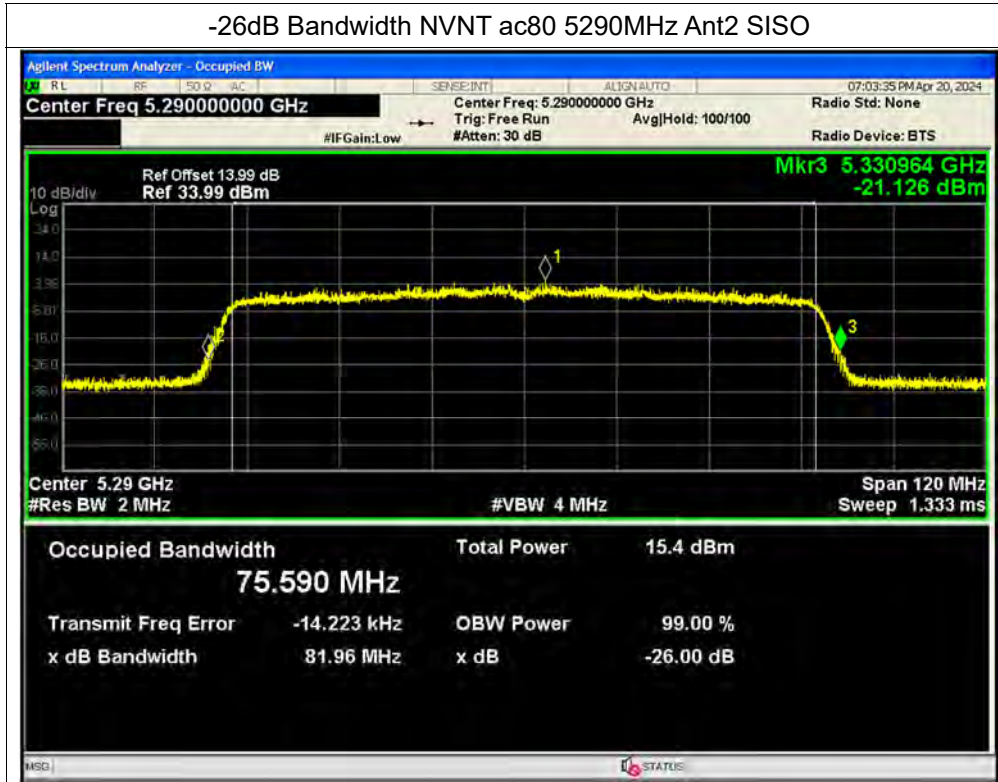

-26dB Bandwidth NVNT ac80 5530MHz Ant2 SISO

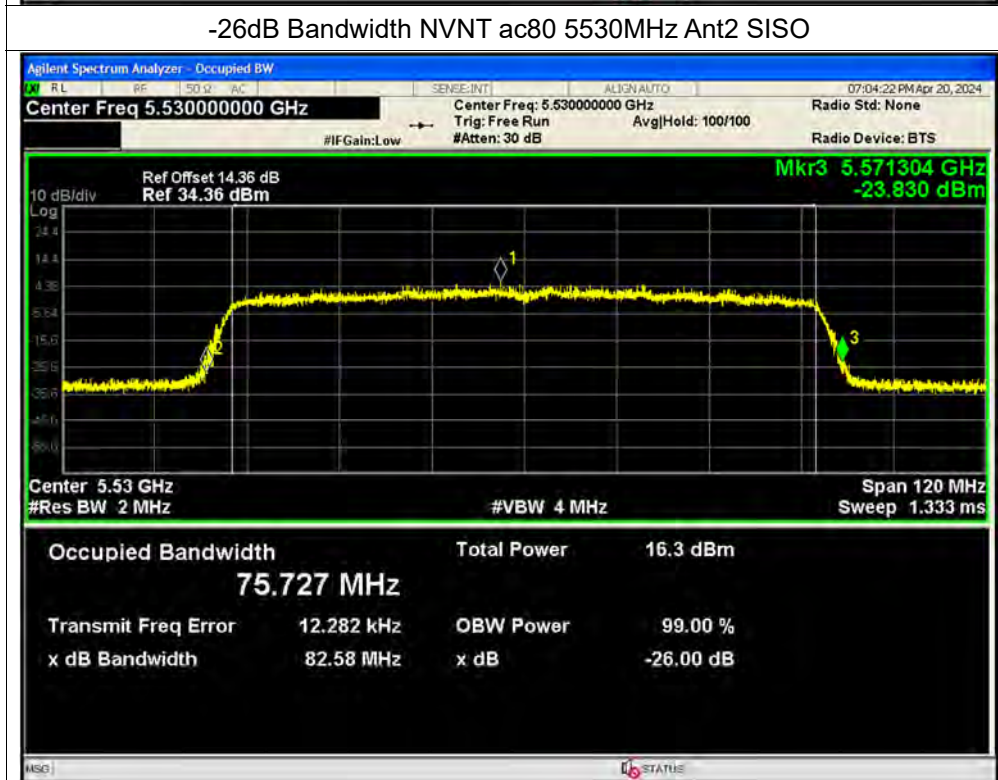



-26dB Bandwidth NVNT ac80 5610MHz Ant2 SISO

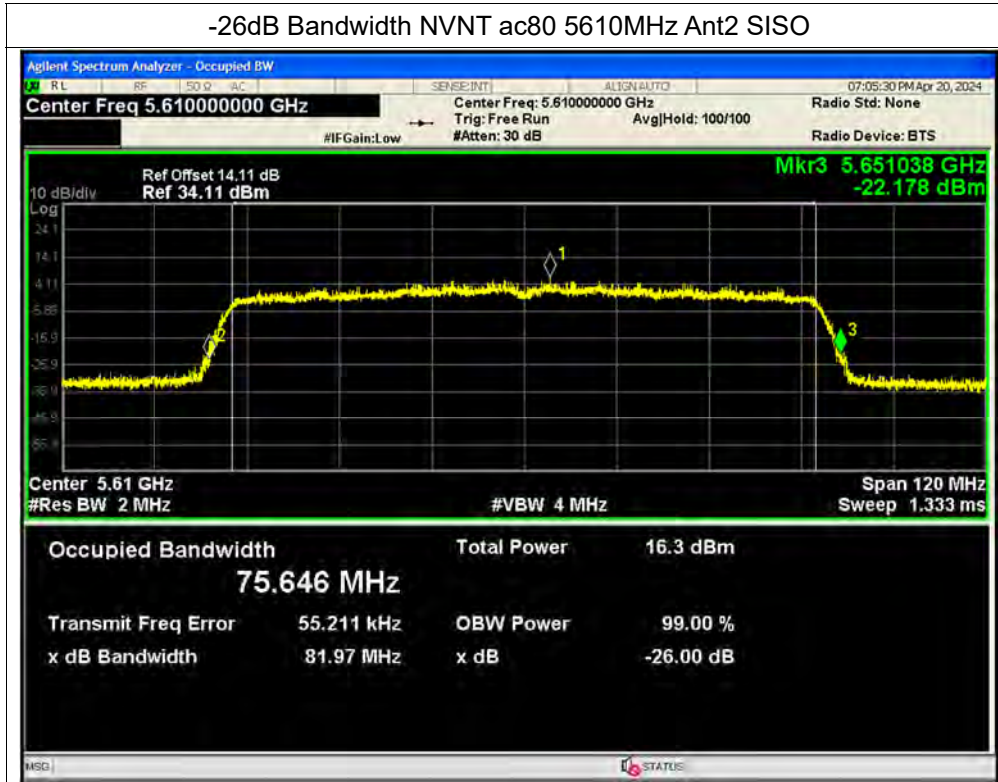

-26dB Bandwidth NVNT ac80 5690MHz Ant2 SISO

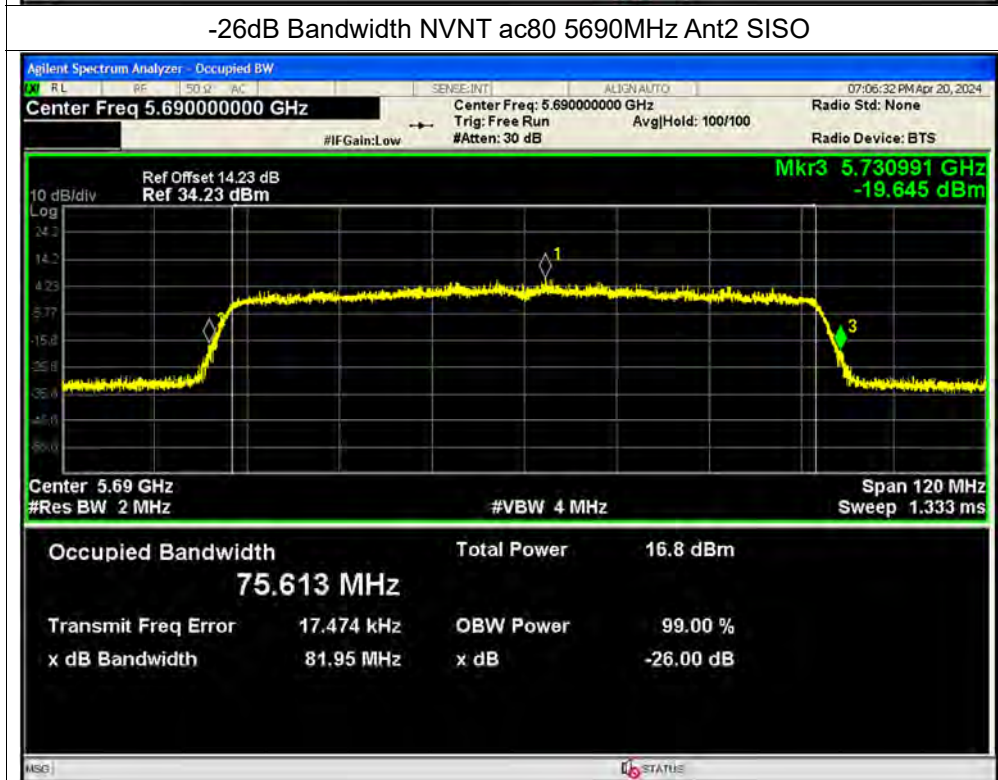



Test Graphs

-6dB Bandwidth NVNT a 5745MHz Ant1 SISO

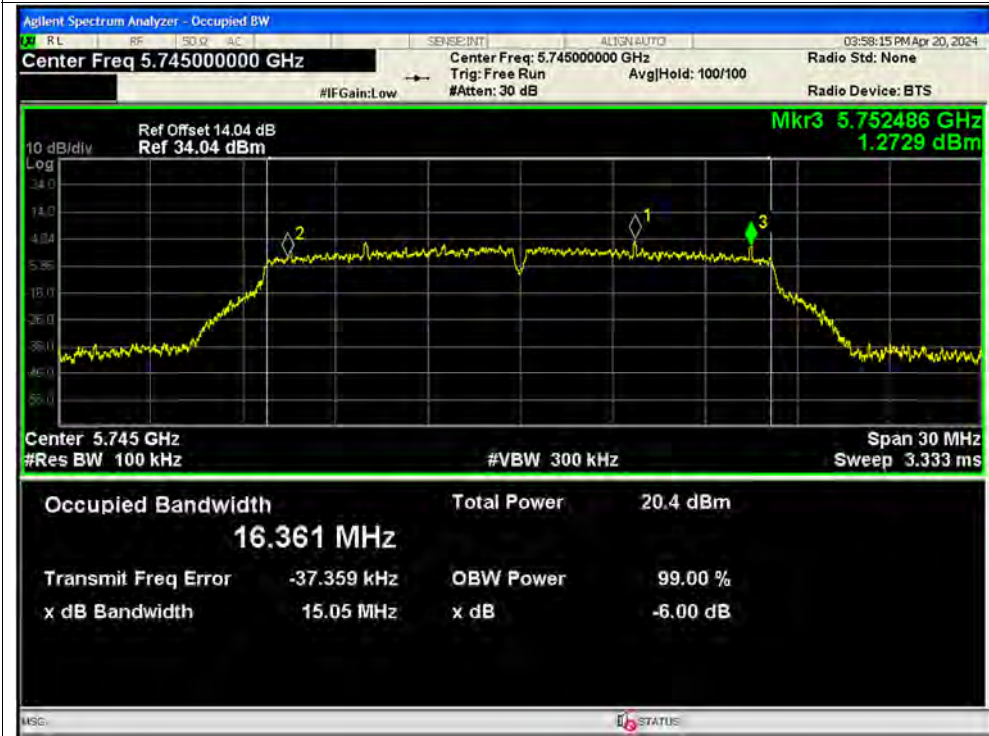

-6dB Bandwidth NVNT a 5785MHz Ant1 SISO

