

---

# SAR Test Report

---

Report No.: AGC01110191017FH01B

**FCC ID** : 2AOKB-A3165

**APPLICATION PURPOSE** : Class II Equipment

**PRODUCT DESIGNATION** : Soundcore Flare 2

**BRAND NAME** : Soundcore

**MODEL NAME** : A3165

**APPLICANT** : Anker Innovations Limited

**DATE OF ISSUE** : Sep. 25, 2023

**STANDARD(S)** : IEEE Std. 1528:2013  
FCC 47 CFR Part 2§2.1093  
IEEE Std C95.1™-2005

**REPORT VERSION** : V1.0

Attestation of Global Compliance (Shenzhen) Co., Ltd.



Any report having not been signed by authorized approver, or having been altered without authorization, or having not been stamped by the "Dedicated Testing/Inspection Stamp" is deemed to be invalid. Copying or excerpting portion of, or altering the content of the report is not permitted without the written authorization of AGC. The test results presented in the report apply only to the tested sample. Any objections to report issued by AGC should be submitted to AGC within 15days after the issuance of the test report. Further enquiry of validity or verification of the test report should be addressed to AGC by [agc01@agccert.com](mailto:agc01@agccert.com).

Attestation of Global Compliance(Shenzhen)Co., Ltd  
Attestation of Global Compliance(Shenzhen)Std & Tech Co., Ltd  
Tel: +86-755 2523 4088 E-mail: [agc@agccert.com](mailto:agc@agccert.com) Web: <http://www.agccert.com/>



### Report Revise Record

Report Version	Revise Time	Issued Date	Valid Version	Notes
V1.0	/	Sep. 25, 2023	Valid	Initial Release

Note: The original test report AGC01110191017FH01A (dated on Jul. 22, 2022 and tested on Jul. 18, 2022) was modified on Sep. 25, 2023, including the following changes and additions:

-Replaced the battery (The battery voltage of the sample changed from 7.2V/17.28Wh to 7.3V/ 17.52Wh);

For the above described changes, all SAR data are retested except the conducted power

Any report having not been signed by authorized approver, or having been altered without authorization, or having not been stamped by the "Dedicated Testing/Inspection Stamp" is deemed to be invalid. Copying or excerpting portion of, or altering the content of the report is not permitted without the written authorization of AGC. The test results presented in the report apply only to the tested sample. Any objections to report issued by AGC should be submitted to AGC within 15days after the issuance of the test report. Further enquiry of validity or verification of the test report should be addressed to AGC by [agc01@agccert.com](mailto:agc01@agccert.com).

Attestation of Global Compliance(Shenzhen)Co., Ltd  
Attestation of Global Compliance(Shenzhen)Std & Tech Co., Ltd  
Tel: +86-755 2523 4088 E-mail: [agc@agccert.com](mailto:agc@agccert.com) Web: <http://www.agccert.com/>

Test Report	
Applicant Name	Anker Innovations Limited
Applicant Address	Room 1318-19, Hollywood Plaza, 610 Nathan Road, Mongkok, Kowloon, Hongkong
Manufacturer Name	Anker Innovations Limited
Manufacturer Address	Room 1318-19, Hollywood Plaza, 610 Nathan Road, Mongkok, Kowloon, Hongkong
Factory Name	N/A
Factory Address	N/A
Product Designation	Soundcore Flare 2
Brand Name	Soundcore
Model Name	A3165
EUT Voltage	DC 7.3V by battery
Applicable Standard	IEEE Std. 1528:2013 FCC 47 CFR Part 2§2.1093 IEEE Std C95.1™-2005
Date of receipt of test item	Aug. 30, 2023
Test Date	Sep. 18, 2023
Report Template	AGCRT-US-2.4G/SAR (2021-04-20)

Note: The results of testing in this report apply to the product/system which was tested only.



Prepared By \_\_\_\_\_

Cool Cheng (Project Engineer)

Sep. 18, 2023



Reviewed By \_\_\_\_\_

Calvin Liu (Reviewer)

Sep. 25, 2023



Approved By \_\_\_\_\_

Max Zhang (Authorized Officer)

Sep. 25, 2023

Any report having not been signed by authorized approver, or having been altered without authorization, or having not been stamped by the "Dedicated Testing/Inspection Stamp" is deemed to be invalid. Copying or excerpting portion of, or altering the content of the report is not permitted without the written authorization of AGC. The test results presented in the report apply only to the tested sample. Any objections to report issued by AGC should be submitted to AGC within 15days after the issuance of the test report. Further enquiry of validity or verification of the test report should be addressed to AGC by agc01@agccert.com.

## TABLE OF CONTENTS

<b>1. SUMMARY OF MAXIMUM SAR VALUE .....</b>	<b>5</b>
<b>2. GENERAL INFORMATION.....</b>	<b>6</b>
2.1. EUT DESCRIPTION.....	6
<b>3. SAR MEASUREMENT SYSTEM.....</b>	<b>7</b>
3.1. THE SATIMO SYSTEM USED FOR PERFORMING COMPLIANCE TESTS CONSISTS OF FOLLOWING ITEMS .....	7
3.2. COMOSAR E-FIELD PROBE .....	8
3.3. ROBOT.....	8
3.4. VIDEO POSITIONING SYSTEM .....	9
3.5. DEVICE HOLDER.....	9
3.6. SAM TWIN PHANTOM.....	10
<b>4. SAR MEASUREMENT PROCEDURE.....</b>	<b>11</b>
4.1. SPECIFIC ABSORPTION RATE (SAR).....	11
4.2. SAR MEASUREMENT PROCEDURE .....	12
4.3. RF EXPOSURE CONDITIONS .....	14
<b>5. TISSUE SIMULATING LIQUID.....</b>	<b>16</b>
5.1. THE COMPOSITION OF THE TISSUE SIMULATING LIQUID.....	16
5.2. TISSUE DIELECTRIC PARAMETERS FOR HEAD AND BODY PHANTOMS .....	16
5.3. TISSUE CALIBRATION RESULT .....	17
<b>6. SAR SYSTEM CHECK PROCEDURE .....</b>	<b>18</b>
6.1. SAR SYSTEM CHECK PROCEDURES .....	18
6.2. SAR SYSTEM CHECK.....	19
<b>7. EUT TEST POSITION.....</b>	<b>21</b>
7.1. TEST POSITION.....	21
<b>8. SAR EXPOSURE LIMITS .....</b>	<b>22</b>
<b>9. TEST FACILITY .....</b>	<b>23</b>
<b>10. TEST EQUIPMENT LIST .....</b>	<b>24</b>
<b>11. MEASUREMENT UNCERTAINTY .....</b>	<b>25</b>
<b>12. CONDUCTED POWER MEASUREMENT.....</b>	<b>28</b>
<b>13. TEST RESULTS.....</b>	<b>29</b>
13.1. SAR TEST RESULTS SUMMARY.....	29
<b>APPENDIX A. SAR SYSTEM CHECK DATA .....</b>	<b>31</b>
<b>APPENDIX B. SAR MEASUREMENT DATA.....</b>	<b>33</b>
<b>APPENDIX C. TEST SETUP PHOTOGRAPHS.....</b>	<b>35</b>
<b>APPENDIX D. CALIBRATION DATA .....</b>	<b>35</b>

Any report having not been signed by authorized approver, or having been altered without authorization, or having not been stamped by the “Dedicated Testing/Inspection Stamp” is deemed to be invalid. Copying or excerpting portion of, or altering the content of the report is not permitted without the written authorization of AGC. The test results presented in the report apply only to the tested sample. Any objections to report issued by AGC should be submitted to AGC within 15days after the issuance of the test report. Further enquiry of validity or verification of the test report should be addressed to AGC by agc01@agccert.com.

## 1. SUMMARY OF MAXIMUM SAR VALUE

The maximum results of Specific Absorption Rate (SAR) found during testing for EUT are as follows:

Frequency Band	Highest Reported 1g-SAR(W/kg)	SAR Test Limit (W/kg)
BT(BR/EDR)	0.119	1.6
SAR Test Result	PASS	

This device is compliance with Specific Absorption Rate (SAR) for general population/uncontrolled exposure limits (1.6W/kg) specified in IEEE Std. 1528:2013; FCC 47CFR § 2.1093; IEEE/ANSI C95.1:2005 and the following specific FCC Test Procedures:

- KDB 447498 D04 General RF Exposure Guidance v01
- KDB 865664 D01 SAR Measurement 100MHz to 6GHz v01r04

Any report having not been signed by authorized approver, or having been altered without authorization, or having not been stamped by the “Dedicated Testing/Inspection Stamp” is deemed to be invalid. Copying or excerpting portion of, or altering the content of the report is not permitted without the written authorization of AGC. The test results presented in the report apply only to the tested sample. Any objections to report issued by AGC should be submitted to AGC within 15days after the issuance of the test report. Further enquiry of validity or verification of the test report should be addressed to AGC by [agc01@agccert.com](mailto:agc01@agccert.com).

## 2. GENERAL INFORMATION

### 2.1. EUT Description

General Information	
Product Designation	Soundcore Flare 2
Test Model	A3165
Hardware Version	H
Software Version	V1.20
Duty cycle for BR&EDR	76.51%
Device Category	Portable
RF Exposure Environment	Uncontrolled
Antenna Type	PCB Antenna
Bluetooth	
Operation Frequency	2402~2480MHz
Antenna Gain	1.56dBi
Bluetooth Version	V5.0
Type of modulation	<b>BR/EDR:</b> GFSK, $\Pi/4$ -DQPSK, 8-DPSK; <b>BLE:</b> GFSK
Max. Peak Power(dBm)	<b>BR/EDR:</b> 12.977dBm ; <b>BLE:</b> 7.934dBm
Power Supply	DC 7.3V, 2400mAh by battery

Note: 1.The sample used for testing is end product.

2. The test sample has no any deviation to the test method of standard mentioned in page 1.

### 3. SAR MEASUREMENT SYSTEM

#### 3.1. The SATIMO system used for performing compliance tests consists of following items

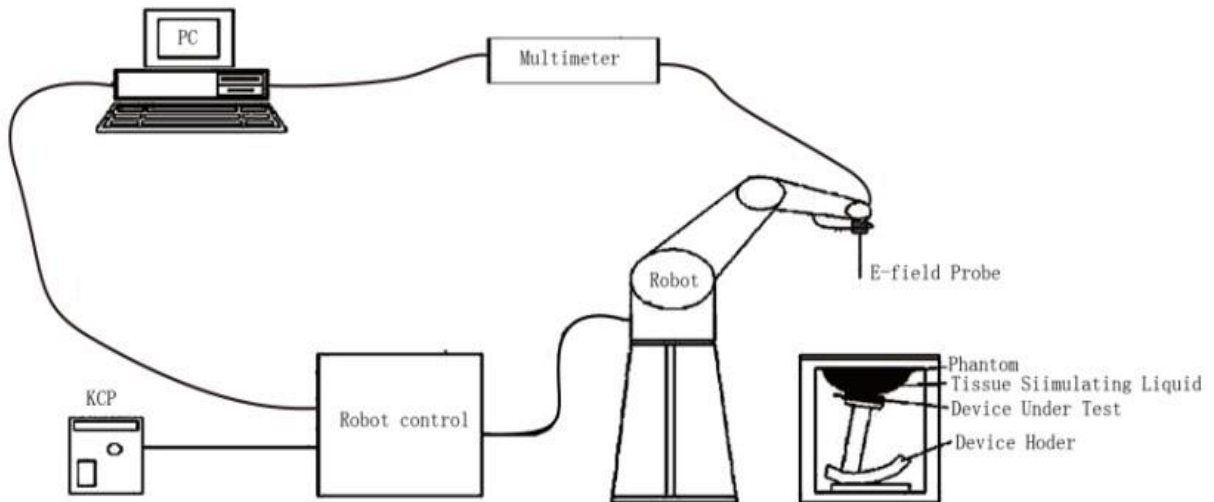

The COMOSAR system for performing compliance tests consists of the following items:

- The PC. It controls most of the bench devices and stores measurement data. A computer running WinXP and the Opensar software.
- The E-Field probe. The probe is a 3-axis system made of 3 distinct dipoles. Each dipole returns a voltage in function of the ambient electric field.
- The Keithley multimeter measures each probe dipole voltages.
- The SAM phantom simulates a human head. The measurement of the electric field is made inside the phantom.
- The liquids simulate the dielectric properties of the human head tissues.
- The network emulator controls the mobile phone under test.
- The validation dipoles are used to measure a reference SAR. They are used to periodically check the bench to make sure that there is no drift of the system characteristics over time.
- The phantom, the device holder and other accessories according to the targeted measurement.

Any report having not been signed by authorized approver, or having been altered without authorization, or having not been stamped by the "Dedicated Testing/Inspection Stamp" is deemed to be invalid. Copying or excerpting portion of, or altering the content of the report is not permitted without the written authorization of AGC. The test results presented in the report apply only to the tested sample. Any objections to report issued by AGC should be submitted to AGC within 15days after the issuance of the test report. Further enquiry of validity or verification of the test report should be addressed to AGC by agc01@agccert.com.

### 3.2. COMOSAR E-Field Probe

The SAR measurement is conducted with the dosimetric probe manufactured by SATIMO. The probe is specially designed and calibrated for use in liquid with high permittivity. The dosimetric probe has special calibration in liquid at different frequency. SATIMO conducts the probe calibration in compliance with international and national standards (e.g. IEEE1528 etc.) Under ISO17025. The calibration data are in Appendix D.

#### Isotropic E-Field Probe Specification

<b>Model</b>	SSE2	
<b>Manufacture</b>	MVG	
<b>Identification No.</b>	SN 45/22 EPGO391	
<b>Frequency</b>	0.15GHz-6GHz Linearity:±0.09dB(0.15GHz-6GHz)	
<b>Dynamic Range</b>	0.01W/kg-100W/kg Linearity:±0.09dB	
<b>Dimensions</b>	Overall length:330mm Length of individual dipoles:2mm Maximum external diameter:8mm Probe Tip external diameter:2.5mm Distance between dipoles/ probe extremity:1mm	
<b>Application</b>	High precision dosimetric measurements in any exposure scenario (e.g., very strong gradient fields). Only probe which enables compliance testing for frequencies up to 6 GHz with precision of better 30%.	

### 3.3. Robot

The COMOSAR system uses the KUKA robot from SATIMO SA (France). For the 6-axis controller COMOSAR system, the KUKA robot controller version from SATIMO is used.

The XL robot series have many features that are important for our application:

- High precision (repeatability 0.02 mm)
- High reliability (industrial design)
- Jerk-free straight movements
- Low ELF interference (the closed metallic construction shields against motor control fields)
- 6-axis controller



Any report having not been signed by authorized approver, or having been altered without authorization, or having not been stamped by the "Dedicated Testing/Inspection Stamp" is deemed to be invalid. Copying or excerpting portion of, or altering the content of the report is not permitted without the written authorization of AGC. The test results presented in the report apply only to the tested sample. Any objections to report issued by AGC should be submitted to AGC within 15 days after the issuance of the test report. Further enquiry of validity or verification of the test report should be addressed to AGC by agc01@agccert.com.



### 3.4. Video Positioning System

The video positioning system is used in OpenSAR to check the probe. Which is composed of a camera, LED, mirror and mechanical parts. The camera is piloted by the main computer with firewire link. During the process, the actual position of the probe tip with respect to the robot arm is measured, as well as the probe length and the horizontal probe offset. The software then corrects all movements, such that the robot coordinates are valid for the probe tip. The repeatability of this process is better than 0.1 mm. If a position has been taught with an aligned probe, the same position will be reached with another aligned probe within 0.1 mm, even if the other probe has different dimensions. During probe rotations, the probe tip will keep its actual position.

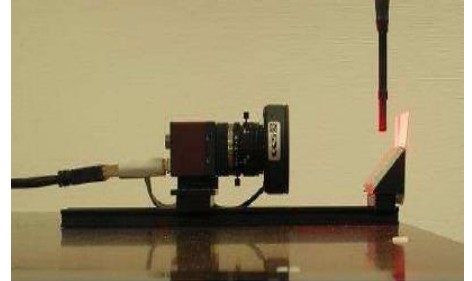

### 3.5. Device Holder

The COMOSAR device holder is designed to cope with different positions given in the standard. It has two scales for the device rotation (with respect to the body axis) and the device inclination (with respect to the line between the ear reference points). The rotation center for both scales is the ear reference point (EPR). Thus the device needs no repositioning when changing the angles. The COMOSAR device holder has been made out of low-loss POM material having the following dielectric parameters: relative permittivity  $\epsilon_r = 3$  and loss tangent  $\delta = 0.02$ . The amount of dielectric material has been reduced in the closest vicinity of the device, since measurements have suggested that the influence of the clamp on the test results could thus be lowered.

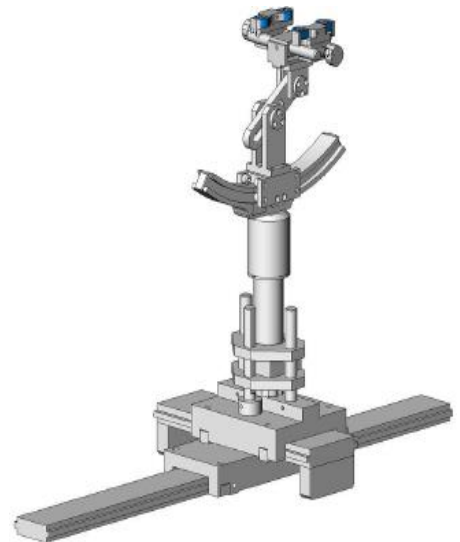

### 3.6. SAM Twin Phantom

The SAM twin phantom is a fiberglass shell phantom with 2mm shell thickness (except the ear region where shell thickness increases to 6mm). It has three measurement areas:

- Left head
- Right head
- Flat phantom



The bottom plate contains three pair of bolts for locking the device holder. The device holder positions are adjusted to the standard measurement positions in the three sections. A white cover is provided to tap the phantom during off-periods to prevent water evaporation and changes in the liquid parameters. On the phantom top, three reference markers are provided to identify the phantom position with respect to the robot.

Any report having not been signed by authorized approver, or having been altered without authorization, or having not been stamped by the “Dedicated Testing/Inspection Stamp” is deemed to be invalid. Copying or excerpting portion of, or altering the content of the report is not permitted without the written authorization of AGC. The test results presented in the report apply only to the tested sample. Any objections to report issued by AGC should be submitted to AGC within 15days after the issuance of the test report. Further enquiry of validity or verification of the test report should be addressed to AGC by [agc01@agccert.com](mailto:agc01@agccert.com).

## 4. SAR MEASUREMENT PROCEDURE

### 4.1. Specific Absorption Rate (SAR)

SAR is related to the rate at which energy is absorbed per unit mass in object exposed to a radio field. The SAR distribution in a biological body is complicated and is usually carried out by experimental techniques or numerical modeling. The standard recommends limits for two tiers of groups, occupational/controlled and occupational/uncontrolled, based on a person's awareness and ability to exercise control over his or her exposure. In general, occupational/controlled exposure limits are higher than the limits for general population/uncontrolled.

The SAR definition is the time derivative (rate) of the incremental energy (dW) absorbed by (dissipated in) an incremental mass (dm) contained in a volume element(dv) of given mass density (ρ). The equation description is as below:

$$SAR = \frac{d}{dt} \left( \frac{dW}{dm} \right) = \frac{d}{dt} \left( \frac{dW}{\rho dV} \right)$$

SAR is expressed in units of Watts per kilogram (W/kg)

SAR can be obtained using either of the following equations:

$$SAR = \frac{\sigma E^2}{\rho}$$

$$SAR = c_h \left. \frac{dT}{dt} \right|_{t=0}$$

Where

SAR	is the specific absorption rate in watts per kilogram;
E	is the r.m.s. value of the electric field strength in the tissue in volts per meter;
σ	is the conductivity of the tissue in siemens per metre;
ρ	is the density of the tissue in kilograms per cubic metre;
c <sub>h</sub>	is the heat capacity of the tissue in joules per kilogram and Kelvin;

$\left. \frac{dT}{dt} \right|_{t=0}$  is the initial time derivative of temperature in the tissue in kelvins per second

## 4.2. SAR Measurement Procedure

### Step 1: Power Reference Measurement

The Power Reference Measurement and Power Drift Measurement are for monitoring the power drift of the device under test in the batch process. The minimum distance of probe sensors to surface is 2.7mm This distance cannot be smaller than the distance os sensor calibration points to probe tip as defined in the probe properties,

### Step 2: Area Scan

The Area Scan is used as a fast scan in two dimensions to find the area of high field values, before doing a fine measurement around the hot spot. The sophisticated interpolation routines implemented in SATIMO software can find the maximum locations even in relatively coarse grids. When an Area Scan has measured all reachable points, it computes the field maximal found in the scanned area, within a range of the global maximum. The range (in db) is specified in the standards for compliance testing. For example, a 2db range is required in IEEE Standard 1528 and IEC62209 standards, whereby 3db is a requirement when compliance is assessed in accordance with the ARIB standard (Japan) If one Zoom Scan follows the Area Scan, then only the absolute maximum will be taken as reference. For cases where multiple maximum are detected, the number of Zoom Scan has to be increased accordingly.

Area Scan Parameters extracted from KDB 865664 D01 SAR Measurement 100MHz to 6GHz

	≤ 3 GHz	> 3 GHz
Maximum distance from closest measurement point (geometric center of probe sensors) to phantom surface	5 ± 1 mm	$\frac{1}{2} \cdot \delta \cdot \ln(2) \pm 0.5$ mm
Maximum probe angle from probe axis to phantom surface normal at the measurement location	30° ± 1°	20° ± 1°
Maximum area scan spatial resolution: $\Delta x_{Area}$ , $\Delta y_{Area}$	≤ 2 GHz: ≤ 15 mm 2 – 3 GHz: ≤ 12 mm	3 – 4 GHz: ≤ 12 mm 4 – 6 GHz: ≤ 10 mm
	When the x or y dimension of the test device, in the measurement plane orientation, is smaller than the above, the measurement resolution must be ≤ the corresponding x or y dimension of the test device with at least one measurement point on the test device.	

### Step 3: Zoom Scan

Zoom Scan are used to assess the peak spatial SAR value within a cubic average volume containing 1g abd 10g of simulated tissue. The Zoom Scan measures points(refer to table below) within a cube whose base faces are centered on the maxima found in a preceding area scan job within the same procedure. When the measurement is done, the Zoom Scan evaluates the averaged SAR for 1g and 10g and displays these values next to the job's label.

Any report having not been signed by authorized approver, or having been altered without authorization, or having not been stamped by the “Dedicated Testing/Inspection Stamp” is deemed to be invalid. Copying or excerpting portion of, or altering the content of the report is not permitted without the written authorization of AGC. The test results presented in the report apply only to the tested sample. Any objections to report issued by AGC should be submitted to AGC within 15days after the issuance of the test report. Further enquiry of validity or verification of the test report should be addressed to AGC by agc01@agccert.com.

Zoom Scan Parameters extracted from KDB865664 d01 SAR Measurement 100MHz to 6GHz

Maximum zoom scan spatial resolution: $\Delta x_{Zoom}$ , $\Delta y_{Zoom}$		$\leq 2$ GHz: $\leq 8$ mm 2 – 3 GHz: $\leq 5$ mm*	3 – 4 GHz: $\leq 5$ mm* 4 – 6 GHz: $\leq 4$ mm*
Maximum zoom scan spatial resolution, normal to phantom surface	uniform grid: $\Delta z_{Zoom}(n)$	$\leq 5$ mm	3 – 4 GHz: $\leq 4$ mm 4 – 5 GHz: $\leq 3$ mm 5 – 6 GHz: $\leq 2$ mm
	graded grid	$\Delta z_{Zoom}(1)$ : between 1 <sup>st</sup> two points closest to phantom surface	$\leq 4$ mm
		$\Delta z_{Zoom}(n>1)$ : between subsequent points	$\leq 1.5 \cdot \Delta z_{Zoom}(n-1)$
Minimum zoom scan volume	x, y, z	$\geq 30$ mm	3 – 4 GHz: $\geq 28$ mm 4 – 5 GHz: $\geq 25$ mm 5 – 6 GHz: $\geq 22$ mm
<p>Note: <math>\delta</math> is the penetration depth of a plane-wave at normal incidence to the tissue medium; see draft standard IEEE P1528-2011 for details.</p> <p>* When zoom scan is required and the <i>reported</i> SAR from the <i>area scan based 1-g SAR estimation</i> procedures of KDB 447498 is <math>\leq 1.4</math> W/kg, <math>\leq 8</math> mm, <math>\leq 7</math> mm and <math>\leq 5</math> mm zoom scan resolution may be applied, respectively, for 2 GHz to 3 GHz, 3 GHz to 4 GHz and 4 GHz to 6 GHz.</p>			

Step 4: Power Drift Measurement

The Power Drift Measurement measures the field at the same location as the most recent power reference measurement within the same procedure, and with the same settings. The Power Drift Measurement gives the field difference in dB from the reading conducted within the same settings. This allows a user to monitor the power drift of the device under test within a batch process. The measurement procedure is the same as Step 1.

Any report having not been signed by authorized approver, or having been altered without authorization, or having not been stamped by the “Dedicated Testing/Inspection Stamp” is deemed to be invalid. Copying or excerpting portion of, or altering the content of the report is not permitted without the written authorization of AGC. The test results presented in the report apply only to the tested sample. Any objections to report issued by AGC should be submitted to AGC within 15days after the issuance of the test report. Further enquiry of validity or verification of the test report should be addressed to AGC by agc01@agccert.com.

### 4.3. RF Exposure Conditions

Test Configuration and setting:

The device is a bluetooth speaker, and supports Bluetooth wireless technology.

For SAR testing, the device was controlled by software to test at reference fixed frequency points.

#### Antenna Location:

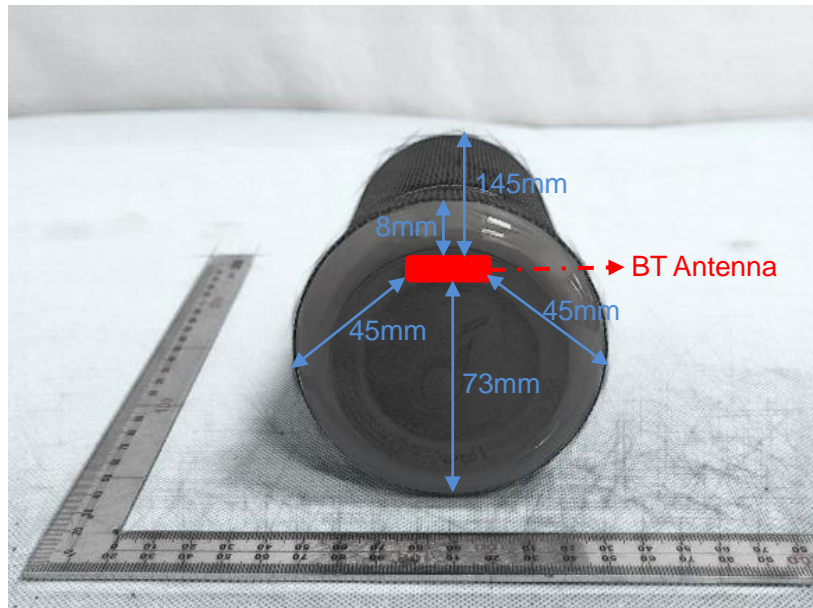

Any report having not been signed by authorized approver, or having been altered without authorization, or having not been stamped by the “Dedicated Testing/Inspection Stamp” is deemed to be invalid. Copying or excerpting portion of, or altering the content of the report is not permitted without the written authorization of AGC. The test results presented in the report apply only to the tested sample. Any objections to report issued by AGC should be submitted to AGC within 15days after the issuance of the test report. Further enquiry of validity or verification of the test report should be addressed to AGC by agc01@agccert.com.

**SAR Test Exclusion Consideration for Adjacent Edges  
Per KDB 447498 D04 Appendix B:**

B.3 MPE-based Exemption: For mobile devices that are not exempt per Table B.1 [Table 1 of § 1.1307(b)(1)(i)(C)] at distances from 20 cm to 40 cm and in 0.3 GHz to 6 GHz, evaluation of compliance with the exposure limits in § 1.1310 is necessary if the ERP of the device is greater than ERP 20cm in Formula (B.1) [repeated from § 2.1091(c)(1) and § 1.1307(b)(1)(i)(B)].

$$P_{th} \text{ (mW)} = ERP_{20 \text{ cm}} \text{ (mW)} = \begin{cases} 2040f & 0.3 \text{ GHz} \leq f < 1.5 \text{ GHz} \\ 3060 & 1.5 \text{ GHz} \leq f \leq 6 \text{ GHz} \end{cases} \quad \text{(B.1)}$$

B.4 SAR-based Exemption: This method shall only be used at separation distances from 0.5 cm to 40 cm and at frequencies from 0.3 GHz to 6 GHz (inclusive).  $P_{th}$  is given by Formula (B.2).

$$P_{th} \text{ (mW)} = \begin{cases} ERP_{20 \text{ cm}}(d/20 \text{ cm})^x & d \leq 20 \text{ cm} \\ ERP_{20 \text{ cm}} & 20 \text{ cm} < d \leq 40 \text{ cm} \end{cases} \quad \text{(B.2)}$$

where

$$x = -\log_{10} \left( \frac{60}{ERP_{20 \text{ cm}} \sqrt{f}} \right)$$

and  $f$  is in GHz,  $d$  is the separation distance (cm), and  $ERP_{20 \text{ cm}}$  is per Formula (B.1).  
The example values shown in Table B.2 are for illustration only.

Table B.2—Example Power Thresholds (mW)

Frequency (MHz)	Distance (mm)									
	5	10	15	20	25	30	35	40	45	50
300	39	65	88	110	129	148	166	184	201	217
450	22	44	67	89	112	135	158	180	203	226
835	9	25	44	66	90	116	145	175	207	240
1900	3	12	26	44	66	92	122	157	195	236
2450	3	10	22	38	59	83	111	143	179	219
3600	2	8	18	32	49	71	96	125	158	195
5800	1	6	14	25	40	58	80	106	136	169

**BR/EDR:**

Ch.(GHz)	Test position	Distance (mm)	x	$P_{th}$ (mW)	Max.power (dBm)	Max.power (mW)	SAR test (Yes/No)
2.480	Top	145	1.905	1658.417	12.977	19.847	No
2.480	Bottom	10	1.905	10.175	12.977	19.847	Yes
2.480	Back	73	1.905	448.723	12.977	19.847	No
2.480	Front	8	1.905	6.652	12.977	19.847	Yes
2.480	Left	45	1.905	178.551	12.977	19.847	No
2.480	Right	45	1.905	178.551	12.977	19.847	No

**BLE\_GFSK 1M:**

Ch.(GHz)	Test position	Distance (mm)	x	$P_{th}$ (mW)	Max.power (dBm)	Max.power (mW)	SAR test (Yes/No)
2.480	Top	145	1.905	1658.417	7.934	6.214	No
2.480	Bottom	10	1.905	10.175	7.934	6.214	No
2.480	Back	73	1.905	448.723	7.934	6.214	No
2.480	Front	8	1.905	6.652	7.934	6.214	No
2.480	Left	45	1.905	178.551	7.934	6.214	No
2.480	Right	45	1.905	178.551	7.934	6.214	No

Any report having not been signed by authorized approver, or having been altered without authorization, or having not been stamped by the "Dedicated Testing/Inspection Stamp" is deemed to be invalid. Copying or excerpting portion of, or altering the content of the report is not permitted without the written authorization of AGC. The test results presented in the report apply only to the tested sample. Any objections to report issued by AGC should be submitted to AGC within 15days after the issuance of the test report. Further enquiry of validity or verification of the test report should be addressed to AGC by agc01@agccert.com.

## 5. TISSUE SIMULATING LIQUID

For SAR measurement of the field distribution inside the phantom, the phantom must be filled with homogeneous tissue simulating liquid to a depth of at least 15cm. For head SAR testing the liquid height from the ear reference point (ERP) of the phantom to the liquid top surface is larger than 15cm For body SAR testing, the liquid height from the center of the flat phantom to the liquid top surface is larger than 15cm. The nominal dielectric values of the tissue simulating liquids in the phantom and the tolerance of 5% are listed in 5.2

### 5.1. The composition of the tissue simulating liquid

Ingredient (% Weight) Frequency (MHz)	Water	Nacl	Polysorbate 20	DGBE	1,2 Propanediol	Triton X-100
2450 Head	71.88	0.16	0.0	7.99	0.0	19.97

### 5.2. Tissue Dielectric Parameters for Head and Body Phantoms

The head tissue dielectric parameters recommended by the IEEE 1528 have been incorporated in the following table. These head parameters are derived from planar layer models simulating the highest expected SAR for the dielectric properties and tissue thickness variations in a human head. Other head and body tissue parameters that have not been specified in IEEE 1528 are derived from the tissue dielectric parameters computed from the 4-Cole-Cole equations described in Reference [12] and extrapolated according to the head parameters specified in IEEE 1528.

Target Frequency (MHz)	head		body	
	$\epsilon_r$	$\sigma$ (S/m)	$\epsilon_r$	$\sigma$ (S/m)
300	45.3	0.87	45.3	0.87
450	43.5	0.87	43.5	0.87
835	41.5	0.90	41.5	0.90
900	41.5	0.97	41.5	0.97
915	41.5	1.01	41.5	1.01
1450	40.5	1.20	40.5	1.20
1610	40.3	1.29	40.3	1.29
1800 – 2000	40.0	1.40	40.0	1.40
<b>2450</b>	<b>39.2</b>	<b>1.80</b>	<b>39.2</b>	<b>1.80</b>
3000	38.5	2.40	38.5	2.40

( $\epsilon_r$  = relative permittivity,  $\sigma$  = conductivity and  $\rho = 1000 \text{ kg/m}^3$ )

Any report having not been signed by authorized approver, or having been altered without authorization, or having not been stamped by the “Dedicated Testing/Inspection Stamp” is deemed to be invalid. Copying or excerpting portion of, or altering the content of the report is not permitted without the written authorization of AGC. The test results presented in the report apply only to the tested sample. Any objections to report issued by AGC should be submitted to AGC within 15days after the issuance of the test report. Further enquiry of validity or verification of the test report should be addressed to AGC by agc01@agccert.com.



### 5.3. Tissue Calibration Result

The dielectric parameters of the liquids were verified prior to the SAR evaluation using SATIMO Dielectric Probe Kit and R&S Network Analyzer ZVL6.

Tissue Stimulant Measurement for 2450MHz					
	Fr. (MHz)	Dielectric Parameters ( $\pm 10\%$ )		Tissue Temp [°C]	Test time
		$\epsilon_r$ 39.2(35.28-43.12)	$\delta$ [s/m]1.80(1.62-1.98)		
Head	2402	40.65	1.76	21.3	Sep. 18, 2023
	2441	40.18	1.77		
	2450	39.61	1.86		
	2480	38.52	1.87		

Any report having not been signed by authorized approver, or having been altered without authorization, or having not been stamped by the “Dedicated Testing/Inspection Stamp” is deemed to be invalid. Copying or excerpting portion of, or altering the content of the report is not permitted without the written authorization of AGC. The test results presented in the report apply only to the tested sample. Any objections to report issued by AGC should be submitted to AGC within 15days after the issuance of the test report. Further enquiry of validity or verification of the test report should be addressed to AGC by agc01@agccert.com.

## 6. SAR SYSTEM CHECK PROCEDURE

### 6.1. SAR System Check Procedures

SAR system check is required to confirm measurement accuracy, according to the tissue dielectric media, probe calibration points and other system operating parameters required for measuring the SAR of a test device. The system verification must be performed for each frequency band and within the valid range of each probe calibration point required for testing the device. The same SAR probe(s) and tissue-equivalent media combinations used with each specific SAR system for system verification must be used for device testing. When multiple probe calibration points are required to cover substantially large transmission bands, independent system verifications are required for each probe calibration point. A system verification must be performed before each series of SAR measurements using the same probe calibration point and tissue-equivalent medium. Additional system verification should be considered according to the conditions of the tissue-equivalent medium and measured tissue dielectric parameters, typically every three to four days when the liquid parameters are remeasured or sooner when marginal liquid parameters are used at the beginning of a series of measurements.

Each SATIMO system is equipped with one or more system check kits. These units, together with the predefined measurement procedures within the SATIMO software, enable the user to conduct the system check and system validation. System kit includes a dipole, and dipole device holder.

The system check verifies that the system operates within its specifications. It's performed daily or before every SAR measurement. The system check uses normal SAR measurement in the flat section of the phantom with a matched dipole at a specified distance. The system check setup is shown as below.

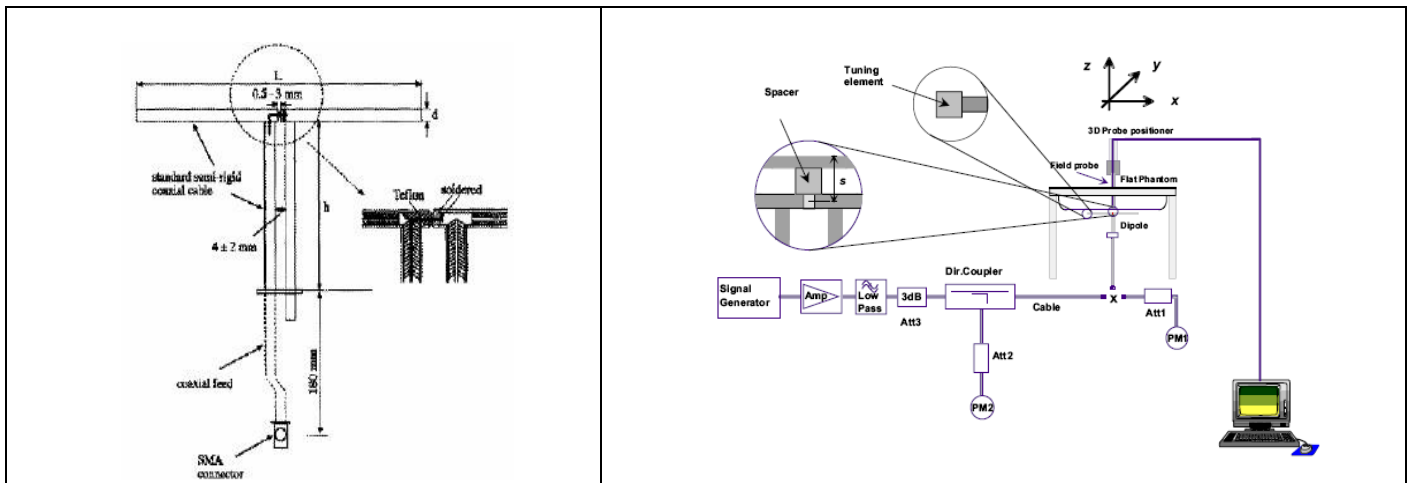

Any report having not been signed by authorized approver, or having been altered without authorization, or having not been stamped by the "Dedicated Testing/Inspection Stamp" is deemed to be invalid. Copying or excerpting portion of, or altering the content of the report is not permitted without the written authorization of AGC. The test results presented in the report apply only to the tested sample. Any objections to report issued by AGC should be submitted to AGC within 15 days after the issuance of the test report. Further enquiry of validity or verification of the test report should be addressed to AGC by [agc01@agccert.com](mailto:agc01@agccert.com).

**6.2. SAR System Check**  
**6.2.1. Dipoles**

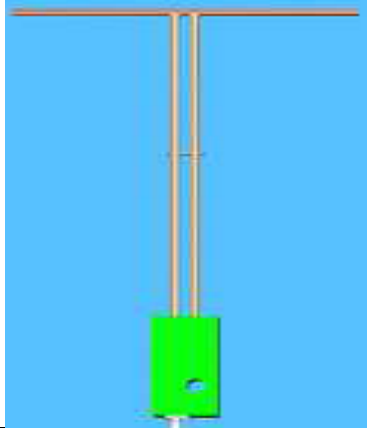
	<p>The dipoles are based on the IEEE-1528 standard, and are complied with mechanical and electrical specifications in line with the requirements of IEEE. the table below provides details for the mechanical and electrical Specifications for the dipoles.</p>
---	--

Frequency	L (mm)	h (mm)	d (mm)
2450MHz	51.5	30.4	3.6

Any report having not been signed by authorized approver, or having been altered without authorization, or having not been stamped by the “Dedicated Testing/Inspection Stamp” is deemed to be invalid. Copying or excerpting portion of, or altering the content of the report is not permitted without the written authorization of AGC. The test results presented in the report apply only to the tested sample. Any objections to report issued by AGC should be submitted to AGC within 15days after the issuance of the test report. Further enquiry of validity or verification of the test report should be addressed to AGC by agc01@agccert.com.

### 6.2.2. System Check Result

System Performance Check at 2450MHz for Head								
Validation Kit: SN 29/15 DIP 2G450-393								
Frequency [MHz]	Target Value(W/kg)		Reference Result ( $\pm 10\%$ )		Normalized to 1W(W/kg)		Tissue Temp. [°C]	Test time
	1g	10g	1g	10g	1g	10g		
2450	54.32	24.25	48.888-59.752	21.825-26.675	57.70	25.76	21.3	Sep. 18, 2023

Note:

(1) We use a CW signal of 18dBm for system check, and then all SAR values are normalized to 1W forward power. The result must be within  $\pm 10\%$  of target value.

Any report having not been signed by authorized approver, or having been altered without authorization, or having not been stamped by the "Dedicated Testing/Inspection Stamp" is deemed to be invalid. Copying or excerpting portion of, or altering the content of the report is not permitted without the written authorization of AGC. The test results presented in the report apply only to the tested sample. Any objections to report issued by AGC should be submitted to AGC within 15days after the issuance of the test report. Further enquiry of validity or verification of the test report should be addressed to AGC by agc01@agccert.com.

## 7. EUT TEST POSITION

This EUT was tested in **Bottom, Front**.

### 7.1. Test Position

- (1) To position the EUT parallel to the phantom surface.
- (2) To adjust the EUT parallel to the flat phantom.
- (3) To adjust the distance between the EUT surface and the flat phantom to **0mm**.

Any report having not been signed by authorized approver, or having been altered without authorization, or having not been stamped by the "Dedicated Testing/Inspection Stamp" is deemed to be invalid. Copying or excerpting portion of, or altering the content of the report is not permitted without the written authorization of AGC. The test results presented in the report apply only to the tested sample. Any objections to report issued by AGC should be submitted to AGC within 15days after the issuance of the test report. Further enquiry of validity or verification of the test report should be addressed to AGC by [agc01@agccert.com](mailto:agc01@agccert.com).

## 8. SAR EXPOSURE LIMITS

### Limits for General Population/Uncontrolled Exposure (W/kg)

Type Exposure	Uncontrolled Environment Limit (W/kg)
Spatial Peak SAR (1 g cube tissue for brain or body)	1.60
Spatial Average SAR (Whole body)	0.08
Spatial Peak SAR (Limbs)	4.0

Any report having not been signed by authorized approver, or having been altered without authorization, or having not been stamped by the "Dedicated Testing/Inspection Stamp" is deemed to be invalid. Copying or excerpting portion of, or altering the content of the report is not permitted without the written authorization of AGC. The test results presented in the report apply only to the tested sample. Any objections to report issued by AGC should be submitted to AGC within 15days after the issuance of the test report. Further enquiry of validity or verification of the test report should be addressed to AGC by [agc01@agccert.com](mailto:agc01@agccert.com).

## 9. TEST FACILITY

<b>Test Site</b>	Attestation of Global Compliance (Shenzhen) Co., Ltd
<b>Location</b>	1-2/F, Building 19, Junfeng Industrial Park, Chongqing Road, Heping Community, Fuhai Street, Bao'an District, Shenzhen, Guangdong, China
<b>Designation Number</b>	CN1259
<b>FCC Test Firm Registration Number</b>	975832
<b>A2LA Cert. No.</b>	5054.02
<b>Description</b>	Attestation of Global Compliance(Shenzhen) Co., Ltd is accredited by A2LA

Any report having not been signed by authorized approver, or having been altered without authorization, or having not been stamped by the "Dedicated Testing/Inspection Stamp" is deemed to be invalid. Copying or excerpting portion of, or altering the content of the report is not permitted without the written authorization of AGC. The test results presented in the report apply only to the tested sample. Any objections to report issued by AGC should be submitted to AGC within 15days after the issuance of the test report. Further enquiry of validity or verification of the test report should be addressed to AGC by [agc01@agccert.com](mailto:agc01@agccert.com).

### 10. TEST EQUIPMENT LIST

Equipment description	Manufacturer/ Model	Identification No.	Software version	Current calibration date	Next calibration date
SAR Probe	MVG	SN 45/22 EPGO391	N/A	Dec. 02, 2022	Dec. 01, 2023
Phantom	SATIMO	SN_4511_SAM90	N/A	Validated. No cal required.	Validated. No cal required.
Liquid	SATIMO	N/A	N/A	Validated. No cal required.	Validated. No cal required.
Multimeter	Keithley 2000	1350784	N/A	Jun. 02, 2023	Jun. 01, 2024
SAR Software	SATIMO-OpenSAR	N/A	OpenSAR V4_02_32	N/A	N/A
Dipole	SATIMO SID2450	SN 29/15 DIP 2G450-393	N/A	Apr. 28,2022	Apr. 27,2025
Signal Generator	Agilent-E4438C	US41461365	V5.03	Jun. 01, 2023	May 31, 2024
EXA Signal Analyzer	Agilent / N9010A	MY53470504	N/A	Jun. 01, 2023	May 31, 2024
Network Analyzer	Rhode & Schwarz ZVL6	N/A	3.2	Oct. 17, 2022	Oct. 16, 2023
Attenuator	Warison /WATT-6SR1211	S/N:WRJ34AYM2F1	N/A	June 07,2023	June 06,2024
Attenuator	Mini-circuits / VAT-10+	31405	N/A	June 07,2023	June 06,2024
Amplifier	AS0104-55_55	1004793	N/A	N/A	N/A
Directional Couple	Werlatone/ C5571-10	SN99463	N/A	Mar. 10,2022	Mar. 09,2024
Directional Couple	Werlatone/ C6026-10	SN99482	N/A	Mar. 10,2022	Mar. 09,2024
Power Sensor	NRP-Z21	1137.6000.02	N/A	Sep. 05,2023	Sep. 04,2024
Power Sensor	NRP-Z23	100323	N/A	Feb. 15,2023	Feb. 14,2024
Power Viewer	R&S	V2.3.1.0		N/A	N/A
Calibration standard parts for network sub - port	R&S/ ZV-Z132	N/A	V2.3.1.0	Nov. 15,2022	Nov. 14,2023

Note: Per KDB 865664 Dipole SAR Validation, AGC Lab has adopted 3 years calibration intervals. On annual basis, every measurement dipole has been evaluated and is in compliance with the following criteria:

1. There is no physical damage on the dipole;
2. System validation with specific dipole is within 10% of calibrated value;
3. Return-loss is within 20% of calibrated measurement;
4. Impedance is within 5Ω of calibrated measurement.

Any report having not been signed by authorized approver, or having been altered without authorization, or having not been stamped by the “Dedicated Testing/Inspection Stamp” is deemed to be invalid. Copying or excerpting portion of, or altering the content of the report is not permitted without the written authorization of AGC. The test results presented in the report apply only to the tested sample. Any objections to report issued by AGC should be submitted to AGC within 15days after the issuance of the test report. Further enquiry of validity or verification of the test report should be addressed to AGC by agc01@agccert.com.



## 11. MEASUREMENT UNCERTAINTY

SATIMO Uncertainty- SN 45/22 EPGO391 Measurement uncertainty for DUT averaged over 1 gram / 10 gram.									
Uncertainty Component	Sec.	Tol (+-%)	Prob. Dist.	Div.	Ci (1g)	Ci (10g)	1g Ui (+-%)	10g Ui (+-%)	vi
<b>Measurement System</b>									
Probe calibration	E.2.1	7.000	N	1	1	1	7.000	7.000	∞
Axial Isotropy	E.2.2	0.215	R	1.732	0.707	0.707	0.088	0.088	∞
Hemispherical Isotropy	E.2.2	0.215	R	1.732	0.707	0.707	0.088	0.088	∞
Boundary effect	E.2.3	1.000	R	1.732	1	1	0.577	0.577	∞
Linearity	E.2.4	0.995	R	1.732	1	1	0.574	0.574	∞
System detection limits	E.2.4	1.000	R	1.732	1	1	0.577	0.577	∞
Modulation response	E.2.5	3.000	R	1.732	1	1	1.732	1.732	∞
Readout Electronics	E.2.6	0.021	N	1	1	1	0.021	0.021	∞
Response Time	E.2.7	0.000	R	1.732	1	1	0.000	0.000	∞
Integration Time	E.2.8	1.400	R	1.732	1	1	0.808	0.808	∞
RF ambient conditions-Noise	E.6.1	3.000	R	1.732	1	1	1.732	1.732	∞
RF ambient conditions-reflections	E.6.1	3.000	R	1.732	1	1	1.732	1.732	∞
Probe positioner mechanical tolerance	E.6.2	1.400	R	1.732	1	1	0.808	0.808	∞
Probe positioning with respect to phantom shell	E.6.3	1.400	R	1.732	1	1	0.808	0.808	∞
Extrapolation, interpolation, and integrations algorithms for max. SAR evaluation	E.5	2.300	R	1.732	1	1	1.328	1.328	∞
<b>Test sample Related</b>									
Test sample positioning	E.4.2	2.6	N	1	1	1	2.60	2.60	∞
Device holder uncertainty	E.4.1	3	N	1	1	1	3.00	3.00	∞
Output power variation—SAR drift measurement	E.2.9	5	R	1.732	1	1	2.89	2.89	∞
SAR scaling	E.6.5	5	R	1.732	1	1	2.89	2.89	∞
<b>Phantom and tissue parameters</b>									
Phantom shell uncertainty—shape, thickness, and permittivity	E.3.1	4	R	1.732	1	1	2.309	2.309	∞
Uncertainty in SAR correction for deviations in permittivity and conductivity	E.3.2	1.9	N	1	1	0.84	1.900	1.596	∞
Liquid conductivity measurement	E.3.3	4	N	1	0.78	0.71	3.120	2.840	M
Liquid permittivity measurement	E.3.3	5	N	1	0.23	0.26	1.150	1.300	M
Liquid conductivity—temperature uncertainty	E.3.4	2.5	R	1.732	0.78	0.71	1.126	1.025	∞
Liquid permittivity—temperature uncertainty	E.3.4	2.5	R	1.732	0.23	0.26	0.332	0.375	∞
Combined Standard Uncertainty			RSS				10.529	10.344	
Expanded Uncertainty (95% Confidence interval)			K=2				21.059	20.689	

Any report having not been signed by authorized approver, or having been altered without authorization, or having not been stamped by the “Dedicated Testing/Inspection Stamp” is deemed to be invalid. Copying or excerpting portion of, or altering the content of the report is not permitted without the written authorization of AGC. The test results presented in the report apply only to the tested sample. Any objections to report issued by AGC should be submitted to AGC within 15days after the issuance of the test report. Further enquiry of validity or verification of the test report should be addressed to AGC by agc01@agccert.com.

SATIMO Uncertainty- SN 45/22 EPGO391									
System Validation uncertainty for DUT averaged over 1 gram / 10 gram.									
Uncertainty Component	Sec.	Tol (+-%)	Prob. Dist.	Div.	Ci (1g)	Ci (10g)	1g Ui (+-%)	10g Ui (+-%)	vi
<b>Measurement System</b>									
Probe calibration	E.2.1	7.000	N	1	1	1	7.000	7.000	∞
Axial Isotropy	E.2.2	0.215	R	1.732	1.000	1.000	0.124	0.124	∞
Hemispherical Isotropy	E.2.2	0.215	R	1.732	0.000	0.000	0.000	0.000	∞
Boundary effect	E.2.3	1.000	R	1.732	1.000	1.000	0.577	0.577	∞
Linearity	E.2.4	0.995	R	1.732	1.000	1.000	0.574	0.574	∞
System detection limits	E.2.4	1.000	R	1.732	1.000	1.000	0.577	0.577	∞
Modulation response	E.2.5	3.000	R	1.732	0.000	0.000	0.000	0.000	∞
Readout Electronics	E.2.6	0.021	N	1.000	1.000	1.000	0.021	0.021	∞
Response Time	E.2.7	0.000	R	1.732	0.000	0.000	0.000	0.000	∞
Integration Time	E.2.8	1.400	R	1.732	0.000	0.000	0.000	0.000	∞
RF ambient conditions-Noise	E.6.1	3.000	R	1.732	1.000	1.000	1.732	1.732	∞
RF ambient conditions-reflections	E.6.1	3.000	R	1.732	1.000	1.000	1.732	1.732	∞
Probe positioner mechanical tolerance	E.6.2	1.400	R	1.732	1.000	1.000	0.808	0.808	∞
Probe positioning with respect to phantom shell	E.6.3	1.400	R	1.732	1.000	1.000	0.808	0.808	∞
Extrapolation, interpolation, and integrations algorithms for max. SAR evaluation	E.5	2.300	R	1.732	1.000	1.000	1.328	1.328	∞
<b>System validation source</b>									
Deviation of experimental dipole from numerical dipole	E.6.4	5	N	1	1	1	5	5	∞
Input power and SAR drift measurement	8,6.6.4	5	R	1.732	1	1	2.887	2.887	∞
Dipole axis to liquid distance	8,E.6.6	2	R	1.732	1	1	1.155	1.155	∞
<b>Phantom and set-up</b>									
Phantom shell uncertainty—shape, thickness, and permittivity	E.3.1	4	R	1.732	1	1	2.309	2.309	∞
Uncertainty in SAR correction for deviations in permittivity and conductivity	E.3.2	1.9	N	1	1	0.84	1.9	1.596	∞
Liquid conductivity (temperature uncertainty)	E.3.3	4	N	1	0.78	0.71	3.12	2.84	∞
Liquid conductivity (measured)	E.3.3	5	N	1	0.23	0.26	1.15	1.3	M
Liquid permittivity (temperature uncertainty)	E.3.4	2.5	R	1.732	0.78	0.71	1.126	1.025	∞
Liquid permittivity (measured)	E.3.4	2.5	R	1.732	0.23	0.26	0.332	0.375	M
Combined Standard Uncertainty			RSS				10.462	10.276	
Expanded Uncertainty (95% Confidence interval)			K=2				20.925	20.552	

Any report having not been signed by authorized approver, or having been altered without authorization, or having not been stamped by the “Dedicated Testing/Inspection Stamp” is deemed to be invalid. Copying or excerpting portion of, or altering the content of the report is not permitted without the written authorization of AGC. The test results presented in the report apply only to the tested sample. Any objections to report issued by AGC should be submitted to AGC within 15days after the issuance of the test report. Further enquiry of validity or verification of the test report should be addressed to AGC by agc01@agccert.com.

SATIMO Uncertainty- SN 45/22 EPGO391									
System Check uncertainty for DUT averaged over 1 gram / 10 gram.									
Uncertainty Component	Sec.	Tol (+-%)	Prob. Dist.	Div.	Ci (1g)	Ci (10g)	1g Ui (+-%)	10g Ui (+-%)	vi
<b>Measurement System</b>									
Probe calibration drift	E.2.1.3	7.000	N	1	1	1	7	7	∞
Axial Isotropy	E.2.2	0.215	R	$\sqrt{3}$	0	0	0	0	∞
Hemispherical Isotropy	E.2.2	0.215	R	$\sqrt{3}$	0	0	0	0	∞
Boundary effect	E.2.3	1.000	R	$\sqrt{3}$	0	0	0	0	∞
Linearity	E.2.4	0.995	R	$\sqrt{3}$	0	0	0	0	∞
System detection limits	E.2.4	1	R	$\sqrt{3}$	0	0	0	0	∞
Modulation response	E.2.5	3	R	$\sqrt{3}$	0	0	0	0	∞
Readout Electronics	E.2.6	0.021	N	$\sqrt{3}$	0	0	0	0	∞
Response Time	E.2.7	0	R	$\sqrt{3}$	0	0	0	0	∞
Integration Time	E.2.8	1.4	R	$\sqrt{3}$	0	0	0	0	∞
RF ambient conditions-Noise	E.6.1	3	R	$\sqrt{3}$	0	0	0	0	∞
RF ambient conditions-reflections	E.6.1	3	R	$\sqrt{3}$	0	0	0	0	∞
Probe positioner mechanical tolerance	E.6.2	1.4	R	$\sqrt{3}$	1	1	0.81	0.81	∞
Probe positioning with respect to phantom shell	E.6.3	1.4	R	$\sqrt{3}$	1	1	0.81	0.81	∞
Extrapolation, interpolation, and integrations algorithms for max. SAR evaluation	E.5	2.3	R	$\sqrt{3}$	0	0	0	0.00	∞
<b>System check source (dipole)</b>									
Deviation of experimental dipoles	E.6.4	2	N	1	1	1	2	2	∞
Input power and SAR drift measurement	8,6.6.4	5	R	$\sqrt{3}$	1	1	2.89	2.89	∞
Dipole axis to liquid distance	8,E.6.6	2	R	$\sqrt{3}$	1	1	1.15	1.15	∞
<b>Phantom and tissue parameters</b>									
Phantom shell uncertainty—shape, thickness, and permittivity	E.3.1	4	R	$\sqrt{3}$	1	1	2.31	2.31	∞
Uncertainty in SAR correction for deviations in permittivity and conductivity	E.3.2	1.9	N	1.000	1	0.84	1.90	1.60	∞
Liquid conductivity measurement	E.3.3	4	N	1.000	0.78	0.71	3.12	2.84	∞
Liquid permittivity measurement	E.3.3	5	N	1.000	0.23	0.26	1.15	1.30	M
Liquid conductivity—temperature uncertainty	E.3.4	2.5	R	$\sqrt{3}$	0.78	0.71	1.13	1.02	∞
Liquid permittivity—temperature uncertainty	E.3.4	2.5	R	$\sqrt{3}$	0.23	0.26	0.33	0.38	M
Combined Standard Uncertainty			RSS				8.927	8.708	
Expanded Uncertainty (95% Confidence interval)			K=2				17.853	17.415	

Any report having not been signed by authorized approver, or having been altered without authorization, or having not been stamped by the “Dedicated Testing/Inspection Stamp” is deemed to be invalid. Copying or excerpting portion of, or altering the content of the report is not permitted without the written authorization of AGC. The test results presented in the report apply only to the tested sample. Any objections to report issued by AGC should be submitted to AGC within 15days after the issuance of the test report. Further enquiry of validity or verification of the test report should be addressed to AGC by agc01@agccert.com.

## 12. CONDUCTED POWER MEASUREMENT

### Bluetooth\_V5.0

Modulation	Channel	Frequency(MHz)	Peak Power (dBm)
BR/EDR			
GFSK	0	2402	11.654
	39	2441	12.456
	78	2480	12.936
$\pi/4$ -DQPSK	0	2402	11.665
	39	2441	12.430
	78	2480	<b>12.977</b>
8-DPSK	0	2402	11.656
	39	2441	12.435
	78	2480	12.927
BLE			
GFSK 1M	0	2402	6.139
	19	2440	7.057
	39	2480	<b>7.934</b>

Any report having not been signed by authorized approver, or having been altered without authorization, or having not been stamped by the "Dedicated Testing/Inspection Stamp" is deemed to be invalid. Copying or excerpting portion of, or altering the content of the report is not permitted without the written authorization of AGC. The test results presented in the report apply only to the tested sample. Any objections to report issued by AGC should be submitted to AGC within 15days after the issuance of the test report. Further enquiry of validity or verification of the test report should be addressed to AGC by agc01@agccert.com.

## 13. TEST RESULTS

### 13.1. SAR Test Results Summary

#### 13.1.1. Test position and configuration

1. The EUT is a model of Bluetooth Speaker.

According to KDB 447498 D04 General RF Exposure Guide v06, due to maximum peak power for bluetooth is more than just a test exclusion threshold, which must be tested.

2. Test procedure:

(1) For the front and bottom side, test 1-g SAR at a test separation distance of 0mm from the flat phantom filled with head tissue simulating Liquid.

3. For SAR testing, the device was controlled by software to test at reference fixed frequency points.

#### 13.1.2. Operation Mode

1. Per KDB 447498 D04 v01 ,for each exposure position, if the highest 1-g SAR is  $\leq 0.8$  W/kg, testing for low and high channel is optional.
2. Per KDB 865664 D01 v01r04,for each frequency band, if the measured SAR is  $\geq 0.8$ W/kg, testing for repeated SAR measurement is required , that the highest measured SAR is only to be tested. When the SAR results are near the limit, the following procedures are required for each device to verify these types of SAR measurement related variation concerns by repeating the highest measured SAR configuration in each frequency band.
  - (1) When the original highest measured SAR is  $\geq 0.8$ W/kg, repeat that measurement once.
  - (2) Perform a second repeated measurement only if the ratio of largest to smallest SAR for the original and first repeated measurements is  $>1.20$  or when the original or repeated measurement is  $\geq 1.45$  W/kg.
  - (3) Perform a third repeated measurement only if the original, first and second repeated measurement is  $\geq 1.5$  W/kg and ratio of largest to smallest SAR for the original, first and second measurement is  $\geq 1.20$ .
3. Maximum Scaling SAR in order to calculate the Maximum SAR values to test under the standard Peak Power, Calculation method is as follows:  
Maximum Scaling SAR =tested SAR (Max.)  $\times$  [maximum turn-up power (mw)/ maximum measurement output power(mw) ]

Any report having not been signed by authorized approver, or having been altered without authorization, or having not been stamped by the "Dedicated Testing/Inspection Stamp" is deemed to be invalid. Copying or excerpting portion of, or altering the content of the report is not permitted without the written authorization of AGC. The test results presented in the report apply only to the tested sample. Any objections to report issued by AGC should be submitted to AGC within 15days after the issuance of the test report. Further enquiry of validity or verification of the test report should be addressed to AGC by agc01@agccert.com.

### 13.1.3. SAR Test Results Summary

SAR MEASUREMENT									
Depth of Liquid (cm):>15					Relative Humidity (%): 62.3				
Product: Soundcore Flare 2									
Position	Mode	Ch.	Fr. (MHz)	Power Drift (<±5%)	SAR (1g) (W/kg)	Max. Tune-up Power (dBm)	Meas. output Power (dBm)	Scaled SAR (W/kg)	Limit W/kg
Test Mode: BT (BR/EDR)									
Bottom	1DH5	39	2441	-0.13	0.084	13.00	12.456	0.095	1.6
Front	1DH5	0	2402	-0.12	0.087	13.00	11.654	<b>0.119</b>	1.6
Front	1DH5	39	2441	0.03	<b>0.100</b>	13.00	12.456	0.113	1.6
Front	1DH5	78	2480	-0.24	0.094	13.00	12.936	0.095	1.6

Note:

- When the 1-g SAR is ≤ 0.8W/kg, testing for low and high channel is optional.
- The test separation of all above table is 0mm.
- Plots are only shown for the bold marked worst case SAR results.

Any report having not been signed by authorized approver, or having been altered without authorization, or having not been stamped by the “Dedicated Testing/Inspection Stamp” is deemed to be invalid. Copying or excerpting portion of, or altering the content of the report is not permitted without the written authorization of AGC. The test results presented in the report apply only to the tested sample. Any objections to report issued by AGC should be submitted to AGC within 15days after the issuance of the test report. Further enquiry of validity or verification of the test report should be addressed to AGC by agc01@agccert.com.

## APPENDIX A. SAR SYSTEM CHECK DATA

Test Laboratory: AGC Lab  
System Check Head 2450 MHz  
DUT: Dipole 2450 MHz Type: SID 2450

Date: Sep. 18, 2023

Communication System CW; Communication System Band: D2450 (2450.0 MHz); Duty Cycle: 1:1; Conv.F=2.34  
Frequency: 2450 MHz; Medium parameters used:  $f = 2450$  MHz;  $\sigma = 1.86$  mho/m;  $\epsilon_r = 39.61$ ;  $\rho = 1000$  kg/m<sup>3</sup> ;  
Phantom section: Flat Section; Input Power=18dBm  
Ambient temperature (°C):21.7, Liquid temperature (°C): 21.3

### SATIMO Configuration

- Probe: SSE2; Calibrated: Dec. 02, 2022; Serial No.: SN 45/22 EPGO391
- Sensor-Surface: 4mm (Mechanical Surface Detection)
- Phantom: SAM twin phantom
- Measurement SW: OpenSAR V4\_02\_32

Configuration/System Check 2450MHz Head/Area Scan: Measurement grid: dx=8mm, dy=8mm

Configuration/System Check 2450MHz Head/Zoom Scan: Measurement grid: dx=5mm,dy=5mm, dz=5mm

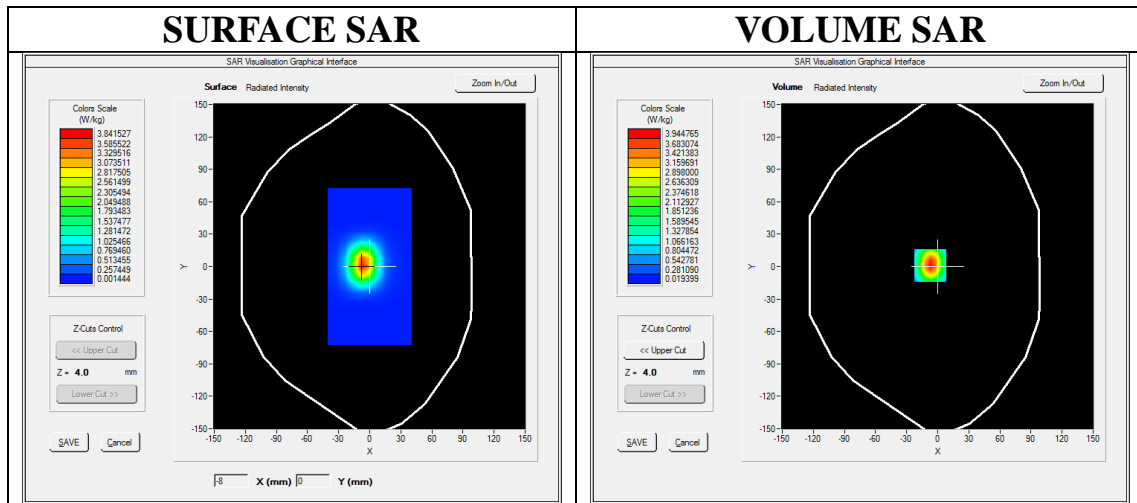

**Maximum location: X=-7.00, Y=1.00**  
**SAR Peak: 6.75 W/kg**

<b>SAR 10g (W/Kg)</b>	1.625540
<b>SAR 1g (W/Kg)</b>	3.640523

Any report having not been signed by authorized approver, or having been altered without authorization, or having not been stamped by the “Dedicated Testing/Inspection Stamp” is deemed to be invalid. Copying or excerpting portion of, or altering the content of the report is not permitted without the written authorization of AGC. The test results presented in the report apply only to the tested sample. Any objections to report issued by AGC should be submitted to AGC within 15days after the issuance of the test report. Further enquiry of validity or verification of the test report should be addressed to AGC by agc01@agccert.com.

Attestation of Global Compliance(Shenzhen)Co., Ltd  
Attestation of Global Compliance(Shenzhen)Std & Tech Co., Ltd  
Tel: +86-755 2523 4088 E-mail: agc@agccert.com Web: http://www.agccert.com/

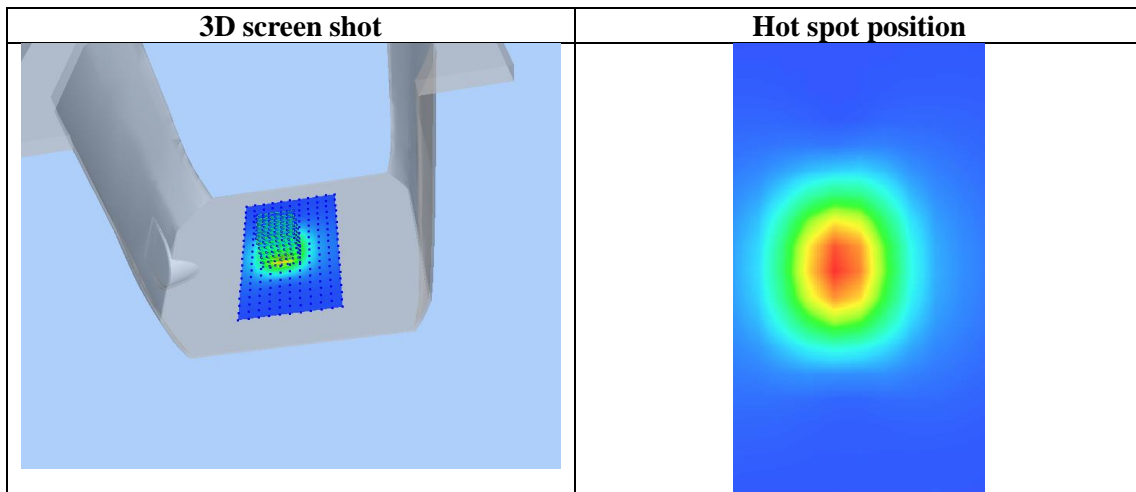
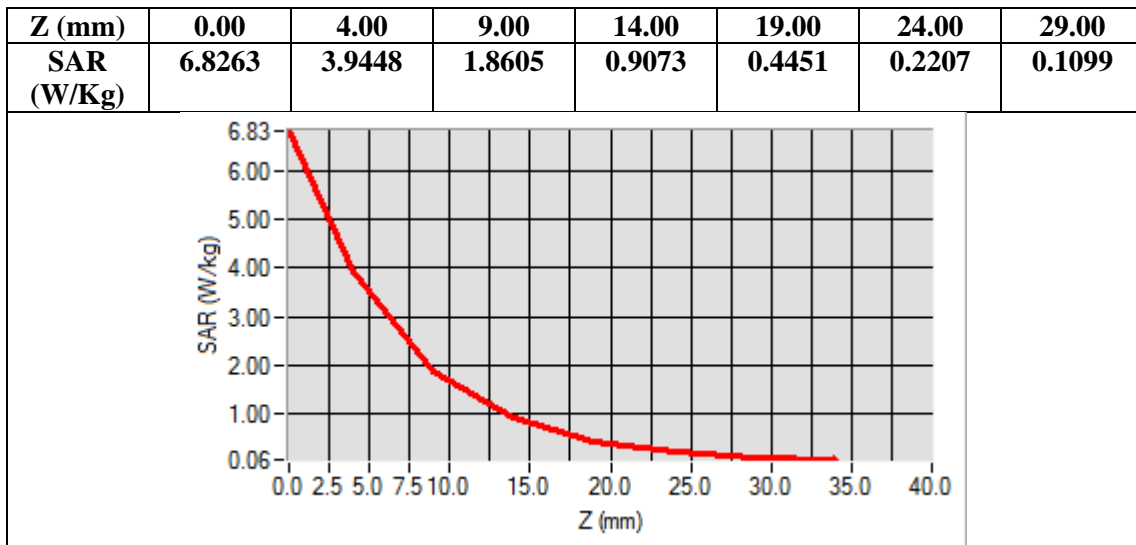

Any report having not been signed by authorized approver, or having been altered without authorization, or having not been stamped by the "Dedicated Testing/Inspection Stamp" is deemed to be invalid. Copying or excerpting portion of, or altering the content of the report is not permitted without the written authorization of AGC. The test results presented in the report apply only to the tested sample. Any objections to report issued by AGC should be submitted to AGC within 15days after the issuance of the test report. Further enquiry of validity or verification of the test report should be addressed to AGC by agc01@agccert.com.



## APPENDIX B. SAR MEASUREMENT DATA

Test Laboratory: AGC Lab  
BT (BR/EDR) Mid- Front (1DH5)  
DUT: Soundcore Flare 2; Type: A3165

Date: Sep. 18, 2023

Communication System: BT; Communication System Band: Bluetooth; Duty Cycle:76.51%;Conv.F=2.34;  
Frequency: 2441 MHz; Medium parameters used:  $f = 2450$  MHz;  $\sigma=1.77$  mho/m;  $\epsilon_r =40.18$ ;  $\rho= 1000$  kg/m<sup>3</sup> ;  
Phantom section: Flat Section  
Ambient temperature (°C):21.7, Liquid temperature (°C): 21.3

### SATIMO Configuration:

- Probe: SSE2; Calibrated: Dec. 02, 2022; Serial No.: SN 45/22 EPGO391
- Sensor-Surface: 4mm (Mechanical Surface Detection)
- Phantom: SAM twin phantom
- Measurement SW: OpenSAR V4\_02\_32

**Configuration/BT (BR/EDR) Mid- Front /Area Scan:** Measurement grid: dx=8mm, dy=8mm  
**Configuration/BT (BR/EDR) Mid- Front /Zoom Scan:** Measurement grid: dx=5mm,dy=5mm, dz=5mm;

<b>Area Scan</b>	surf_sam_plan.txt, h= 5.00 mm
<b>ZoomScan</b>	7x7x7,dx=5mm dy=5mm dz=5mm
<b>Phantom</b>	Validation plane
<b>Device Position</b>	Front
<b>Band</b>	BT (BR/EDR)
<b>Channels</b>	Middle
<b>Signal</b>	Crest factor: 1.31

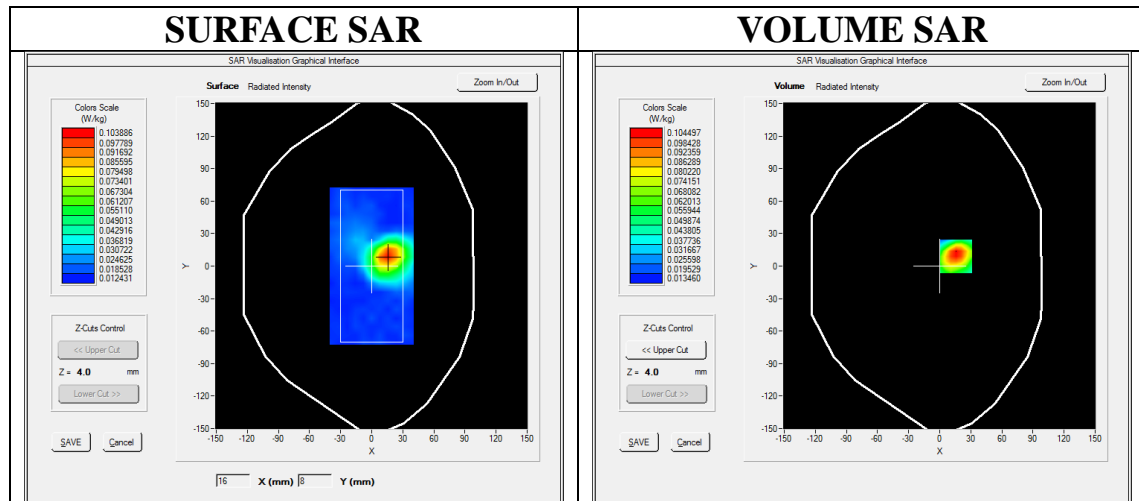

**Maximum location: X=16.00, Y=9.00**

**SAR Peak: 0.19 W/kg**

<b>SAR 10g (W/Kg)</b>	0.049615
<b>SAR 1g (W/Kg)</b>	0.100189

Any report having not been signed by authorized approver, or having been altered without authorization, or having not been stamped by the "Dedicated Testing/Inspection Stamp" is deemed to be invalid. Copying or excerpting portion of, or altering the content of the report is not permitted without the written authorization of AGC. The test results presented in the report apply only to the tested sample. Any objections to report issued by AGC should be submitted to AGC within 15days after the issuance of the test report. Further enquiry of validity or verification of the test report should be addressed to AGC by agc01@agccert.com.

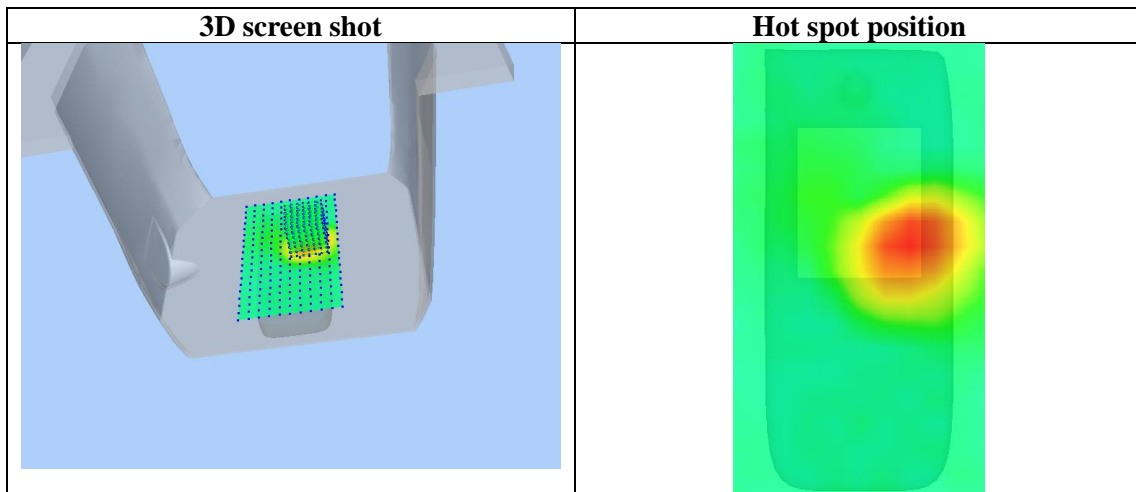
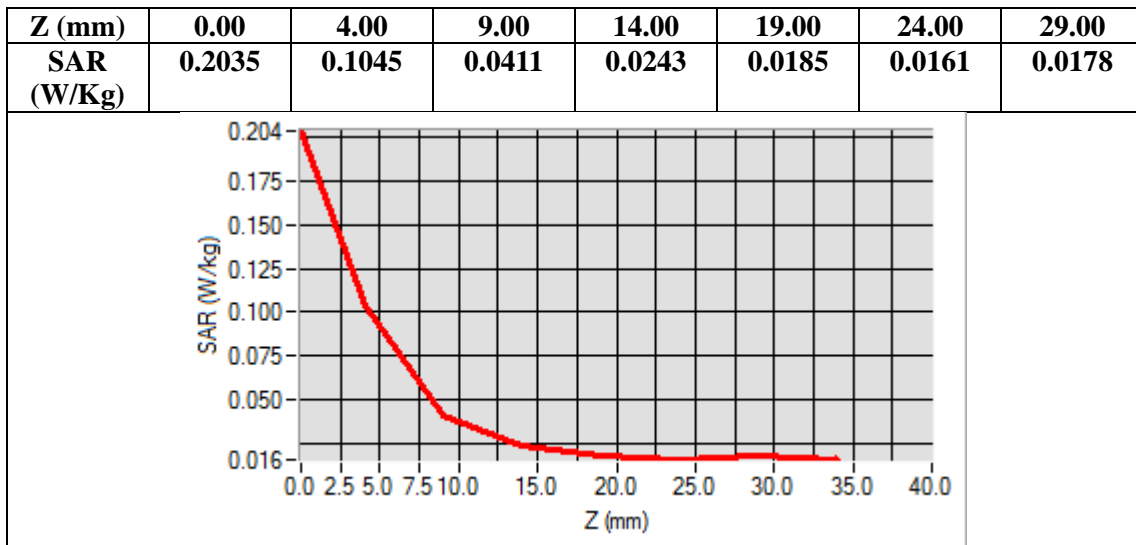

Any report having not been signed by authorized approver, or having been altered without authorization, or having not been stamped by the “Dedicated Testing/Inspection Stamp” is deemed to be invalid. Copying or excerpting portion of, or altering the content of the report is not permitted without the written authorization of AGC. The test results presented in the report apply only to the tested sample. Any objections to report issued by AGC should be submitted to AGC within 15days after the issuance of the test report. Further enquiry of validity or verification of the test report should be addressed to AGC by agc01@agccert.com.

## **APPENDIX C. TEST SETUP PHOTOGRAPHS**

Refer to Attached files.

## **APPENDIX D. CALIBRATION DATA**

Refer to Attached files.

**----END OF REPORT----**

Any report having not been signed by authorized approver, or having been altered without authorization, or having not been stamped by the “Dedicated Testing/Inspection Stamp” is deemed to be invalid. Copying or excerpting portion of, or altering the content of the report is not permitted without the written authorization of AGC. The test results presented in the report apply only to the tested sample. Any objections to report issued by AGC should be submitted to AGC within 15days after the issuance of the test report. Further enquiry of validity or verification of the test report should be addressed to AGC by [agc01@agccert.com](mailto:agc01@agccert.com).

Attestation of Global Compliance(Shenzhen)Co., Ltd  
Attestation of Global Compliance(Shenzhen)Std & Tech Co., Ltd  
Tel: +86-755 2523 4088 E-mail: [agc@agccert.com](mailto:agc@agccert.com) Web: <http://www.agccert.com/>



## Conditions of Issuance of Test Reports

1. All samples and goods are accepted by the Attestation of Global Compliance (Shenzhen) Co., Ltd (the “Company”) solely for testing and reporting in accordance with the following terms and conditions. The company provides its services on the basis that such terms and conditions constitute express agreement between the company and any person, firm or company requesting its services (the “Clients”).
2. Any report issued by Company as a result of this application for testing services (the “Report”) shall be issued in confidence to the Clients and the Report will be strictly treated as such by the Company. It may not be reproduced either in its entirety or in part and it may not be used for advertising or other unauthorized purposes without the written consent of the Company. The Clients to whom the Report is issued may, however, show or send it, or a certified copy thereof prepared by the Company to its customer, supplier or other persons directly concerned. The Company will not, without the consent of the Clients, enter into any discussion or correspondence with any third party concerning the contents of the Report, unless required by the relevant governmental authorities, laws or court orders.
3. The Company shall not be called or be liable to be called to give evidence or testimony on the Report in a court of law without its prior written consent, unless required by the relevant governmental authorities, laws or court orders.
4. In the event of the improper use of the report as determined by the Company, the Company reserves the right to withdraw it, and to adopt any other additional remedies which may be appropriate.
5. Samples submitted for testing are accepted on the understanding that the Report issued cannot form the basis of, or be the instrument for, any legal action against the Company.
6. The Company will not be liable for or accept responsibility for any loss or damage however arising from the use of information contained in any of its Reports or in any communication whatsoever about its said tests or investigations.
7. Clients wishing to use the Report in court proceedings or arbitration shall inform the Company to that effect prior to submitting the sample for testing.
8. The Company is not responsible for recalling the electronic version of the original report when any revision is made to them. The Client assumes the responsibility to providing the revised version to any interested party who uses them.
9. Subject to the variable length of retention time for test data and report stored hereinto as otherwise specifically required by individual accreditation authorities, the Company will only keep the supporting test data and information of the test report for a period of six years. The data and information will be disposed of after the aforementioned retention period has elapsed. Under no circumstances shall we provide any data and information which has been disposed of after retention period. Under no circumstances shall we be liable for damage of any kind, including (but not limited to) compensatory damages, lost profits, lost data, or any form of special, incidental, indirect, consequential or punitive damages of any kind, whether based on breach of contract of warranty, tort (including negligence), product liability or otherwise, even if we are informed in advance of the possibility of such damages.

Any report having not been signed by authorized approver, or having been altered without authorization, or having not been stamped by the “Dedicated Testing/Inspection Stamp” is deemed to be invalid. Copying or excerpting portion of, or altering the content of the report is not permitted without the written authorization of AGC. The test results presented in the report apply only to the tested sample. Any objections to report issued by AGC should be submitted to AGC within 15days after the issuance of the test report. Further enquiry of validity or verification of the test report should be addressed to AGC by [agc01@agccert.com](mailto:agc01@agccert.com).