



TEST REPORT

FCC Rules and Regulations Part 15 Subpart C Section 15.247

ANSI C63.10: 2013

RSS-GEN: Issue 5

RSS-247: Issue 2

**Test report
On Behalf of
Anker Innovations Limited
For
Soundcore Ace A1
Model No.: A3151
FCC ID: 2AOKB-A3151
IC: 23451-A3151**

Prepared for : Anker Innovations Limited
Room 1318-19, Hollywood Plaza, 610 Nathan Road, Mongkok, Kowloon,
Hongkong

Prepared By : Shenzhen HUAKE Testing Technology Co., Ltd.
1F, B2 Building, JunfengZhongchengZhizao Innovation Park, Fuhai Street,
Bao'an District, Shenzhen City, China

Date of Test: Feb.15, 2019 ~ Fed. 27, 2019

Date of Report: Mar. 20, 2019

Report Number: HK1902180257E



TEST RESULT CERTIFICATION

Applicant's name : Anker Innovations Limited
 Address..... : Room 1318-19, Hollywood Plaza, 610 Nathan Road, Mongkok, Kowloon, Hongkong
Manufacture's Name..... : Anker Innovations Limited
 Address..... : Room 1318-19, Hollywood Plaza, 610 Nathan Road, Mongkok, Kowloon, Hongkong
Factory's Name : Dongguan Jianguan Plastic Electronics Co., Ltd.
 Address : Ludong Village, Humen Town, Dongguan City, Guangdong Province, P.R. China

Product description

Trade Mark:..... Soundcore
 ProductName..... : Soundcore Ace A1
 Model and/or type reference... : A3151
 Standards..... : FCC Rules and Regulations Part 15 Subpart C Section 15.247
 ANSI C63.10: 2013
 RSS-GEN: Issue 5
 RSS-247: Issue 2

This publication may be reproduced in whole or in part for non-commercial purposes as long as the Shenzhen HUAKE Testing Technology Co., Ltd. is acknowledged as copyright owner and source of the material. Shenzhen HUAKE Testing Technology Co., Ltd. takes no responsibility for and will not assume liability for damages resulting from the reader's interpretation of the reproduced material due to its placement and context.

Date of Test..... :
 Date (s) of performance of tests..... : Feb.15, 2019 ~ Fed. 27, 2019
 Date of Issue..... : Mar. 20, 2019
 Test Result..... : **Pass**

Testing Engineer : Gary Qian
 (Gary Qian)

Technical Manager : Eden Hu
 (Eden Hu)

Authorized Signatory : Jason Zhou
 (Jason Zhou)



TABLE OF CONTENTS	PAGE
1 . TEST SUMMARY	5
2 . GENERAL INFORMATION	6
2.1 .GENERAL DESCRIPTION OF EUT	6
2.2 . CARRIER FREQUENCY OF CHANNELS	7
2.3 . OPERATION OF EUT DURING TESTING	7
2.4 . DESCRIPTION OF TEST SETUP	8
2.5.EQUIPMENT USED IN EUT SYSTEM	8
2.6.MEASUREMENT INSTRUMENTS LIST	9
3. PEAK OUTPUT POWER	10
3.1. MEASUREMENT PROCEDURE	10
3.2. TEST SET-UP (BLOCK DIAGRAM OF CONFIGURATION)	10
3.3. LIMITS AND MEASUREMENT RESULT	11
4. BANDWIDTH	15
4.1. MEASUREMENT PROCEDURE	15
4.2. TEST SET-UP (BLOCK DIAGRAM OF CONFIGURATION)	15
4.3. LIMITS AND MEASUREMENT RESULTS	15
5. CONDUCTED SPURIOUS EMISSION	20
5.1. MEASUREMENT PROCEDURE	20
5.2. TEST SET-UP (BLOCK DIAGRAM OF CONFIGURATION)	20
5.3. LIMITS AND MEASUREMENT RESULT	21
6. RADIATED EMISSION	25
6.1. TEST LIMIT	25
6.2. MEASUREMENT PROCEDURE	25
6.3. TEST SETUP	27
6.4. TEST RESULT	29
7.1. MEASUREMENT PROCEDURE	33
7.2. TEST SET-UP	33
7.3. TEST RESULT	34
8. NUMBER OF HOPPING FREQUENCY	38
8.1. MEASUREMENT PROCEDURE	38
8.2. TEST SETUP (BLOCK DIAGRAM OF CONFIGURATION)	38
8.3. LIMITS AND MEASUREMENT RESULT	38
9. TIME OF OCCUPANCY (DWELL TIME)	39
9.1. MEASUREMENT PROCEDURE	39



TABLE OF CONTENTS	PAGE
9.2. TEST SETUP (BLOCK DIAGRAM OF CONFIGURATION)	39
9.3. LIMITS AND MEASUREMENT RESULT	39
10. FREQUENCY SEPARATION	42
10.1. MEASUREMENT PROCEDURE	42
10.2. TEST SETUP (BLOCK DIAGRAM OF CONFIGURATION)	42
10.3. LIMITS AND MEASUREMENT RESULT	42
11. LINE CONDUCTED EMISSION TEST	43
11.1. LIMITS OF LINE CONDUCTED EMISSION TEST	43
11.2. BLOCK DIAGRAM OF LINE CONDUCTED EMISSION TEST	43
11.3. PRELIMINARY PROCEDURE OF LINE CONDUCTED EMISSION TEST	44
11.4. FINAL PROCEDURE OF LINE CONDUCTED EMISSION TEST	44
11.5. TEST RESULT OF LINE CONDUCTED EMISSION TEST	45
12. ANTENNA REQUIREMENT	47
APPENDIX A: PHOTOGRAPHS OF TEST SETUP	48
APPENDIX B: PHOTOGRAPHS OF EUT	48



1. TEST SUMMARY

1.1. TEST PROCEDURES AND RESULTS

DESCRIPTION OF TEST	RESULT
Peak Output Power	Compliant
20 dB Bandwidth	Compliant
Conducted Spurious Emission	Compliant
Radiated Emission	Compliant
Band Edges	Compliant
Number of hopping frequency	Compliant
Time of Occupancy	Compliant
Frequency Separation	Compliant
Line conduction Emission	Compliant

1.2. TEST FACILITY

1.2.1 Address of the test laboratory

Shenzhen HUAKE Testing Technology Co., Ltd.

Add.:1F, B2 Building, JunfengZhongchengZhizao Innovation Park,Heping Community, Fuhai Street, Bao'an District, Shenzhen, China

There is one 3m semi-anechoic chamber and two line conducted labs for final test. The Test Sites meet the requirements in documents ANSI C63.4 and CISPR 32/EN 55032 requirements.

1.2.2 Laboratory accreditation

The test facility is recognized, certified, or accredited by the following organizations:

IC Registration No.: 21210

The 3m alternate test site of Shenzhen HUAKE Testing Technology Co., Ltd. EMC Laboratory has been registered by Certification and Engineer Bureau of Industry Canada for the performance of with Registration No.: 21210 on May 24, 2016.

FCC Registration No.: CN1229

Test Firm Registration Number : 616276

1.3. MEASUREMENT UNCERTAINTY

Measurement Uncertainty

Conducted Emission Expanded Uncertainty = 2.23dB, k=2

Radiated emission expanded uncertainty(9kHz-30MHz) = 3.08dB, k=2

Radiated emission expanded uncertainty(30MHz-1000MHz) = 4.42dB, k=2

Radiated emission expanded uncertainty(Above 1GHz) = 4.06dB, k=2



2. GENERAL INFORMATION

2.1. GENERAL DESCRIPTION OF EUT

Operation Frequency	2.402 GHz to 2.480GHz
RF Output Power	-3.423dBm(Max)
Bluetooth Version	V4.2
Modulation	BR <input checked="" type="checkbox"/> GFSK, EDR <input checked="" type="checkbox"/> π /4-DQPSK, <input type="checkbox"/> 8DPSK BLE <input type="checkbox"/> GFSK
Number of channels	79 for BR/EDR
Hardware Version	V4.0
Software Version	V1.0
Antenna Designation	PCB Antenna
Antenna Gain	0dBi
Power Supply	DC 3.7V by battery
Note: 1. The USB port only used for charging and can't be used to transfer data with PC. 2. The EUT doesn't support 8DPSK and BLE.	



2.2. CARRIER FREQUENCY OF CHANNELS

BR/EDR Channel List

Frequency Band	Channel Number	Frequency
2400~2483.5MHz	00	2402MHz
	01	2403MHz
	:	:
	38	2440 MHz
	39	2441 MHz
	40	2442 MHz
	:	:
	77	2479 MHz
	78	2480 MHz

2.3. OPERATION OF EUT DURING TESTING

NO.	TEST MODE DESCRIPTION
1	Low channel GFSK
2	Middle channel GFSK
3	High channel GFSK
4	Low channel $\pi/4$ -DQPSK
5	Middle channel $\pi/4$ -DQPSK
6	High channel $\pi/4$ -DQPSK
7	BT Link(Hopping mode)
8	BT Link with charging

Note: 1. All the test modes can be supply by battery, only the result of the worst case was recorded in the report, if no other cases.
2. For Radiated Emission, 3axis were chosen for testing for each applicable mode.
3. The EUT used fully-charged battery when tested.
4. For Conducted Test method, a temporary antenna connector is provided by the manufacture.



2.4. DESCRIPTION OF TEST SETUP

Configure 1: (Normal hopping)

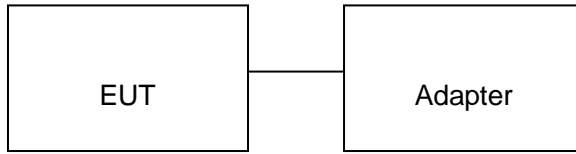

Note: Owing to the EUT has own battery, and testing may be performed while adapter removed.

Configure 2: (Control continuous TX)

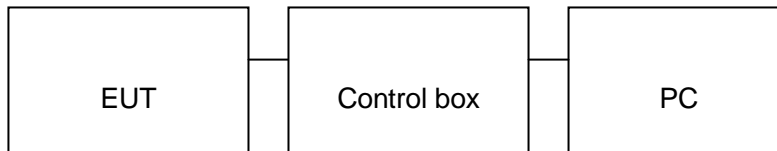

2.5. EQUIPMENT USED IN EUT SYSTEM

Item	Equipment	Mfr/Brand	Model/Type No.	Remark
1	Soundcore Ace A1	Soundcore	A3151	EUT
2	Battery	GF	633042	Accessory
3	IPOD	APPLE	A1367	A.E
4	Control box	GZUT	USB TO TTL	A.E
5	Adapter	HUAWEI	HW-059200CHQ	A.E
7	USB Cable	N/A	0.6m unshielded	Accessory

**2.6.MEASUREMENT INSTRUMENTS LIST****TEST EQUIPMENT OF CONDUCTED EMISSION TEST**

Item	Equipment	Manufacturer	Model No.	Lab Equipment No.	Last Cal.	Cal. Interval
1.	L.I.S.N. Artificial Mains Network	R&S	ENV216	HKE-002	Dec. 27, 2018	1 Year
2.	Receiver	R&S	ESCI 7	HKE-010	Dec. 27, 2018	1 Year

TEST EQUIPMENT OF RADIATED EMISSION TEST

Item	Equipment	Manufacturer	Model No.	Lab Equipment No.	Last Cal.	Cal. Interval
1.	Spectrum analyzer	Agilent	N9020A	HKE-048	Dec. 27, 2018	1 Year
2.	Preamplifier	Schwarzbeck	BBV 9743	HKE-006	Dec. 27, 2018	1 Year
3.	EMI Test Receiver	Rohde & Schwarz	ESCI 7	HKE-010	Dec. 27, 2018	1 Year
4.	Bilog Broadband Antenna	Schwarzbeck	VULB9163	HKE-012	Dec. 27, 2018	1 Year
5.	Loop Antenna	Schwarzbeck	FMZB 1519 B	HKE-014	Dec. 27, 2018	1 Year
6.	Horn Antenna	Schwarzbeck	9120D	HKE-013	Dec. 27, 2018	1 Year
7.	Broad-band Horn Antenna	A-INFOMW	LB-180400-KF	HKE-031	Dec. 27, 2018	1 Year
8.	Pre-amplifier	EMCI	EMC051845SE	HKE-015	Dec. 27, 2018	1 Year
9.	Pre-amplifier	Agilent	83051A	HKE-016	Dec. 27, 2018	1 Year
10.	Radiation Cable 1	MXT	HK1	R05	N/A	N/A
11.	Radiation Cable 2	MXT	HK1	R06	N/A	N/A



3. PEAK OUTPUT POWER

3.1. MEASUREMENT PROCEDURE

For peak power test:

1. Connect EUT RF output port to the Spectrum Analyzer through an RF attenuator
2. Set the EUT Work on the top, middle and the bottom operation frequency individually.
3. $RBW >$ the 20 dB bandwidth of the emission being measured, $VBW \geq RBW$.
4. Record the maximum power from the Spectrum Analyzer.
5. The maximum peak power shall be less 21dBm.

3.2. TEST SET-UP (BLOCK DIAGRAM OF CONFIGURATION)

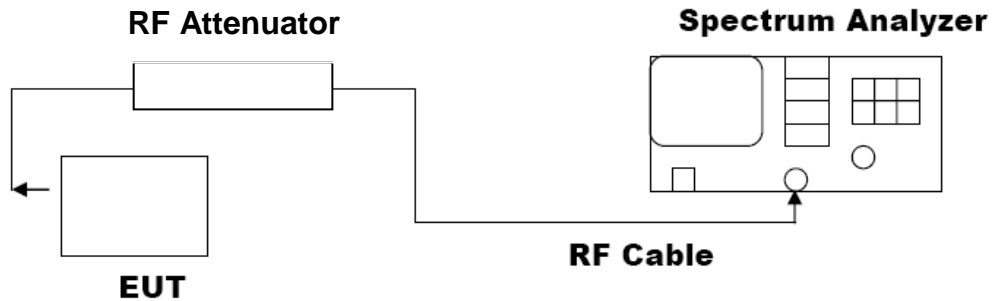



3.3. LIMITS AND MEASUREMENT RESULT

PEAK OUTPUT POWER MEASUREMENT RESULT FOR GFSK MODULATION			
Frequency (GHz)	Peak Power (dBm)	Applicable Limits (dBm)	Pass or Fail
2.402	-4.451	21	Pass
2.441	-4.843	21	Pass
2.480	-5.788	21	Pass

CH00

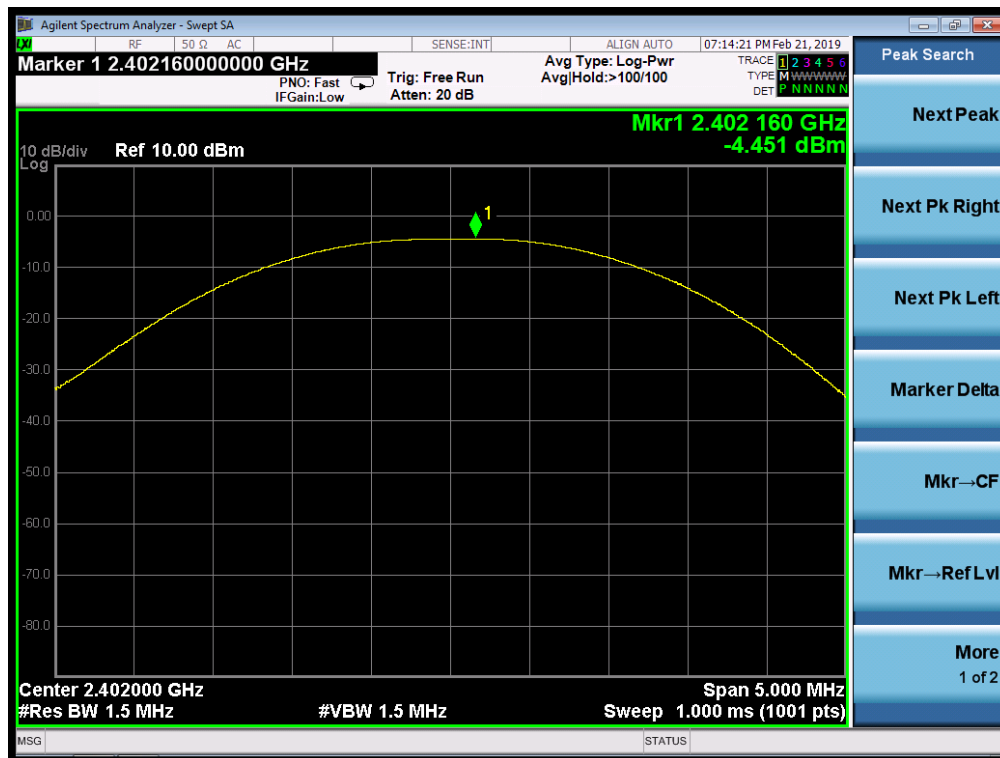



CH39



CH78

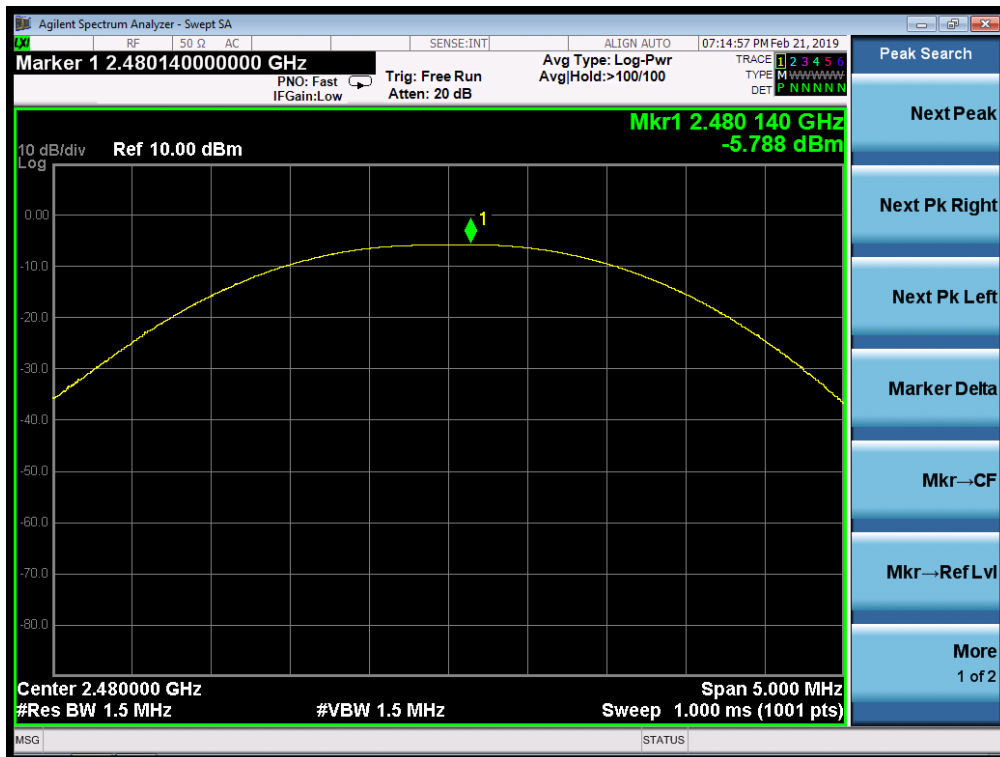



PEAK OUTPUT POWER MEASUREMENT RESULT FOR Π /4-DQPSK MODULATION			
Frequency (GHz)	Peak Power (dBm)	Applicable Limits (dBm)	Pass or Fail
2.402	-3.423	21	Pass
2.441	-3.836	21	Pass
2.480	-4.780	21	Pass

CH00





CH39



CH78

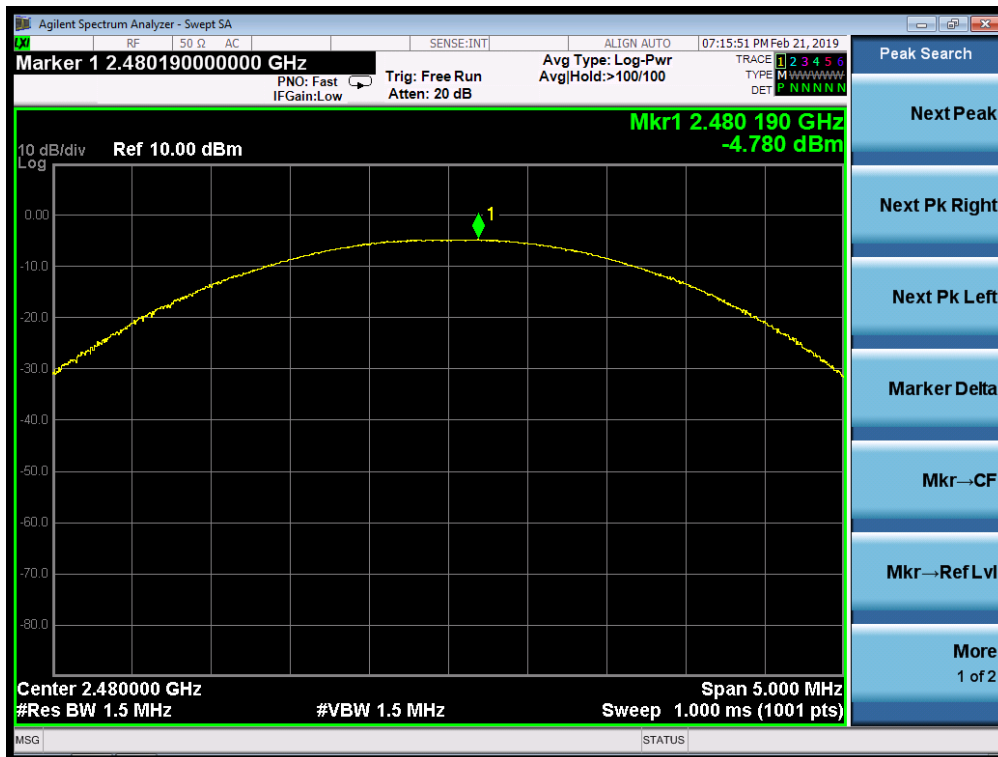



4. BANDWIDTH

4.1. MEASUREMENT PROCEDURE

1. Connect EUT RF output port to the Spectrum Analyzer through an RF attenuator
2. Set the EUT Work on the top, the middle and the bottom operation frequency individually.
3. Set Span = approximately 2 to 3 times the 20 dB bandwidth, centered on a hopping channel
 $RBW \geq 1\%$ of the 20 dB bandwidth, $VBW \geq 3RBW$; Sweep = auto; Detector function = peak
4. Set SPA Trace 1 Max hold, then View.

4.2. TEST SET-UP (BLOCK DIAGRAM OF CONFIGURATION)

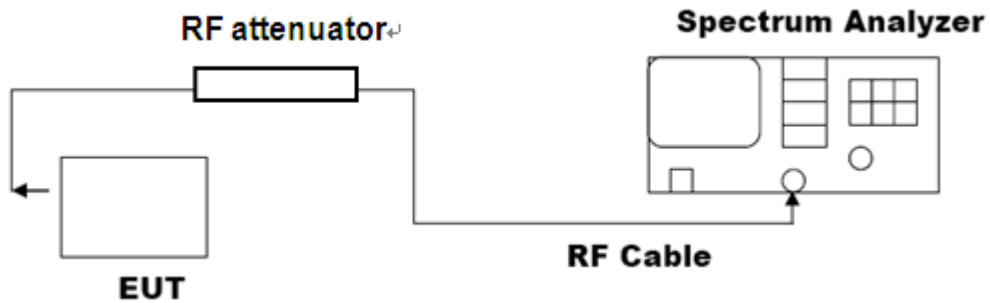

Note: The EUT has been used temporary antenna connector for testing.

4.3. LIMITS AND MEASUREMENT RESULTS

BLUETOOTH 1MBPS LIMITS AND MEASUREMENT RESULT				
Applicable Limits	Measurement Result			
	Test Data (MHz)			Result
		99%OBW (MHz)	-20dB BW(MHz)	
N/A	Low Channel	0.822	0.841	PASS
	Middle Channel	0.819	0.801	PASS
	High Channel	0.815	0.835	PASS



TEST PLOT OF BANDWIDTH FOR LOW CHANNEL

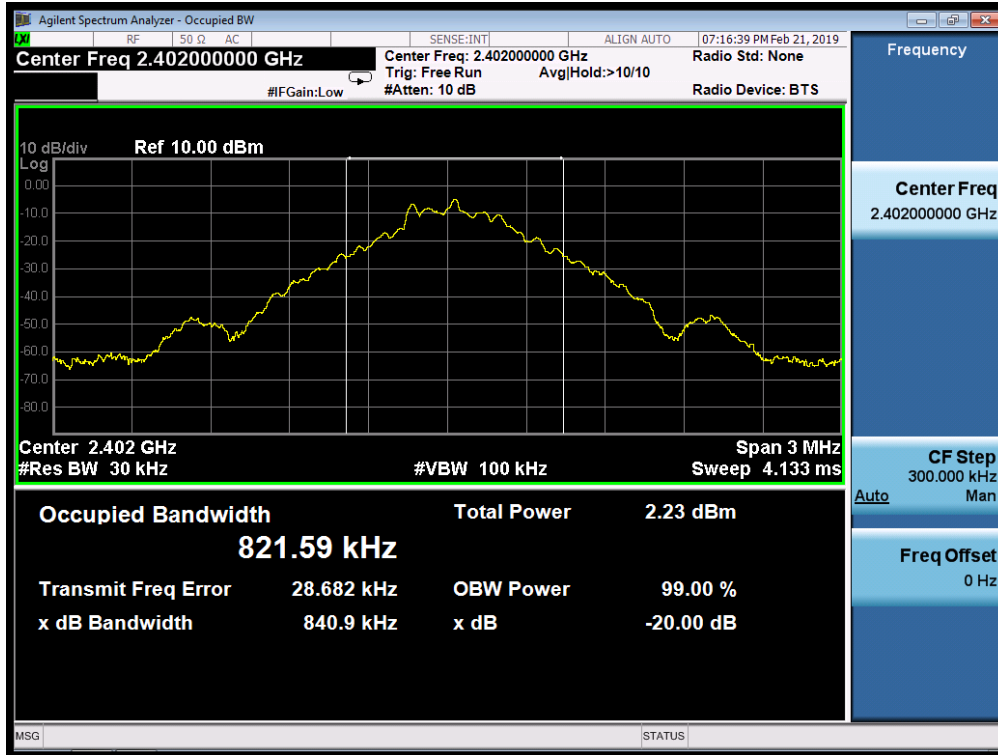

TEST PLOT OF BANDWIDTH FOR MIDDLE CHANNEL

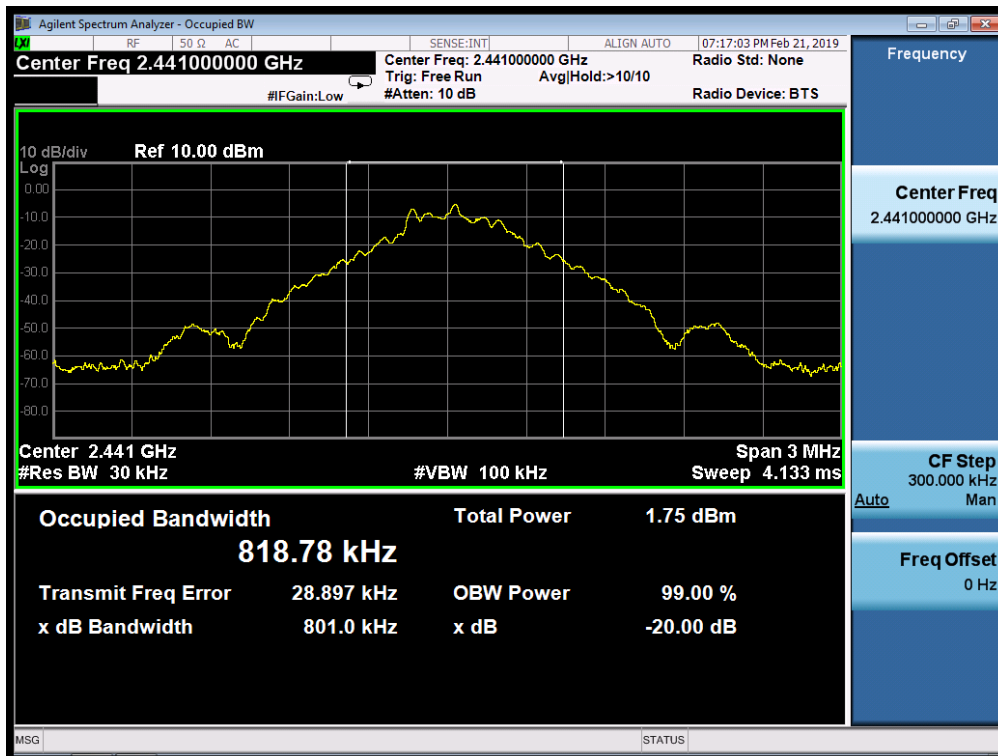



TEST PLOT OF BANDWIDTH FOR HIGH CHANNEL

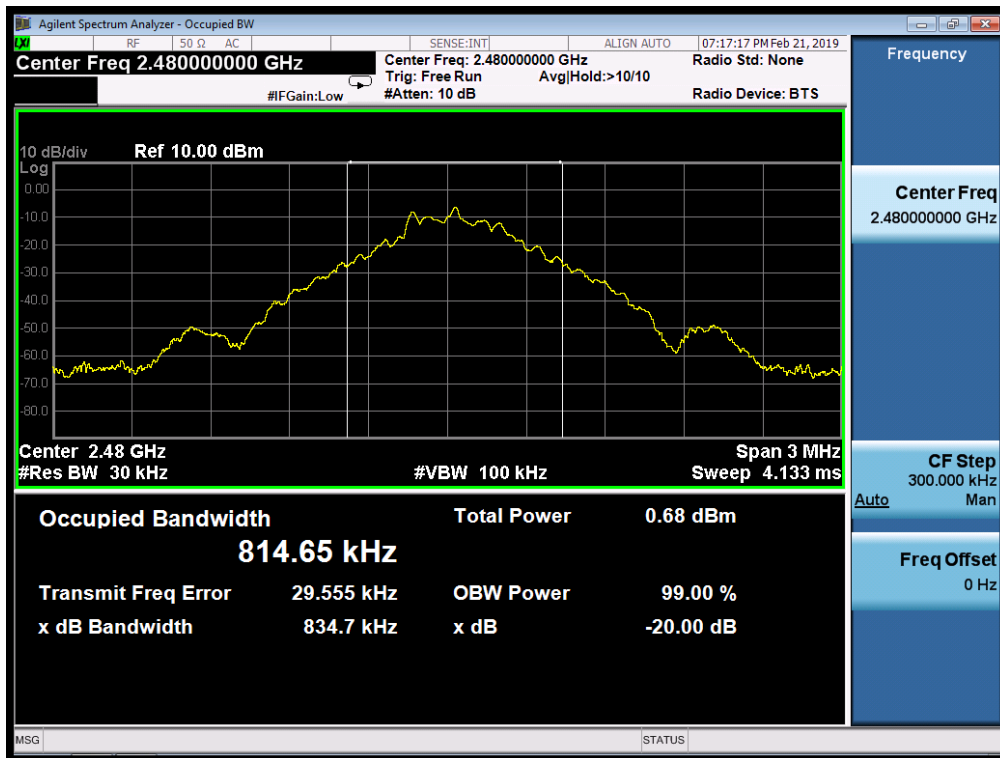



BLUETOOTH 2MBPS LIMITS AND MEASUREMENT RESULT				
Applicable Limits	Measurement Result			
	Test Data (MHz)			Result
		99%OBW (MHz)	-20dB BW(MHz)	
N/A	Low Channel	1.177	1.247	PASS
	Middle Channel	1.175	1.255	PASS
	High Channel	1.173	1.249	PASS

TEST PLOT OF BANDWIDTH FOR LOW CHANNEL

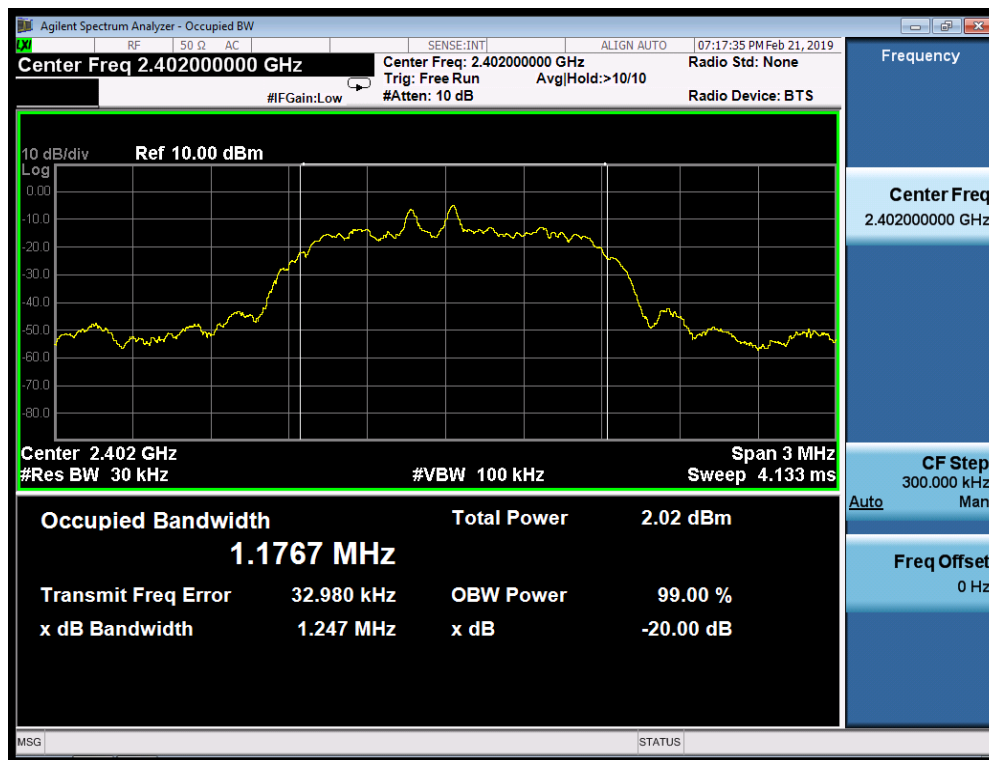



TEST PLOT OF BANDWIDTH FOR MIDDLE CHANNEL

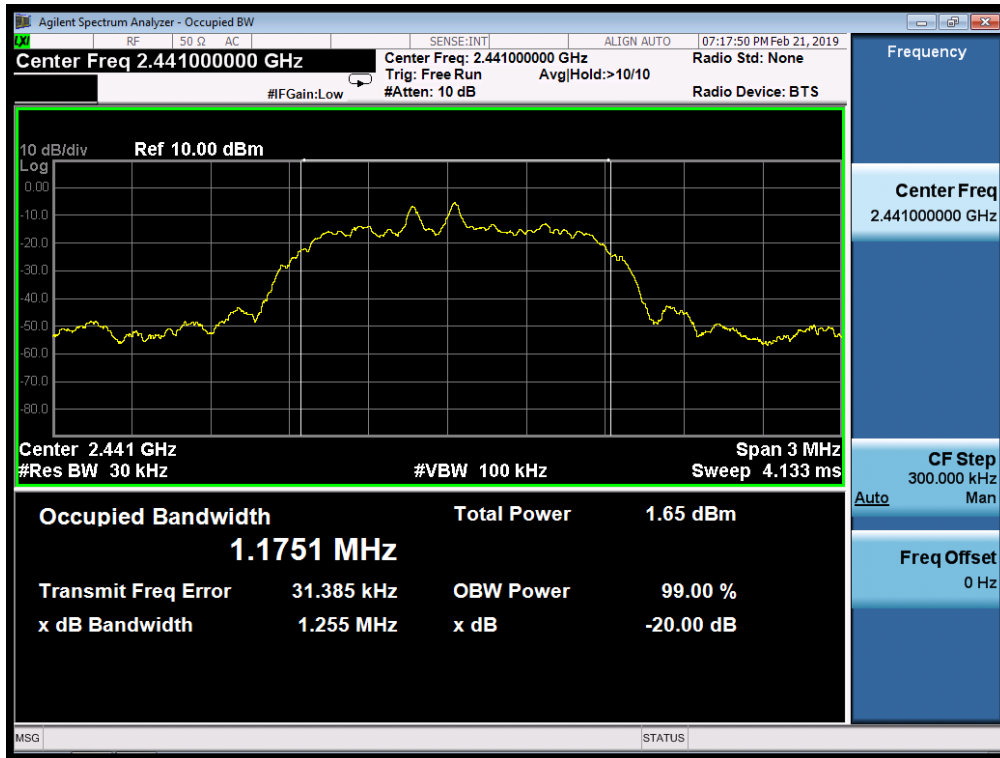

TEST PLOT OF BANDWIDTH FOR HIGH CHANNEL

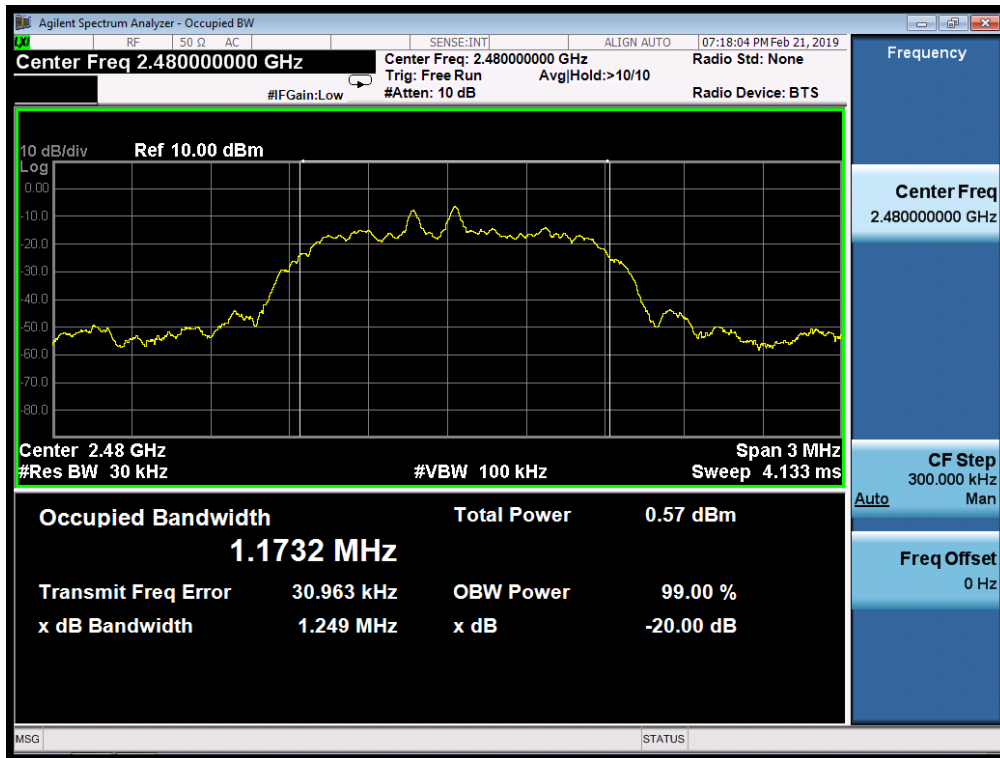



5. CONDUCTED SPURIOUS EMISSION

5.1. MEASUREMENT PROCEDURE

1. Connect EUT RF output port to the Spectrum Analyzer through an RF attenuator
2. Set the EUT Work on the top, the Middle and the bottom operation frequency individually.
3. Set the Span = wide enough to capture the peak level of the in-band emission and all spurious emissions from the lowest frequency generated in the EUT up through the 10th harmonic.
RBW = 100 kHz; VBW = 300kHz; Sweep = auto; Detector function = peak.
4. Set SPA Trace 1 Max hold, then View.

5.2. TEST SET-UP (BLOCK DIAGRAM OF CONFIGURATION)

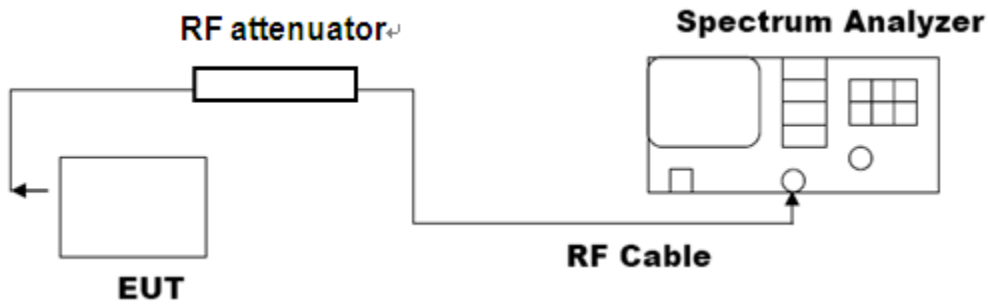



5.3. LIMITS AND MEASUREMENT RESULT

LIMITS AND MEASUREMENT RESULT		
Applicable Limits	Measurement Result	
	Test Data	Result
<p>FCC requirement: In any 100 KHz Bandwidth Outside the frequency band in which the spread spectrum intentional radiator is operating, the radio frequency power that is produce by the intentional radiator shall be at least 20 dB below that in 100KHz bandwidth within the band that contains the highest level of the desired power. In addition, radiation emissions which fall in the restricted bands, as defined in §15.205(a), must also comply with the radiated emission limits specified in§15.209(a))</p> <p>IC requirement: In any 100 kHz bandwidth outside the frequency band in which the spread spectrum or digitally modulated device is operating, the RF power that is produced shall be at least 20 dB below that in the 100 kHz bandwidth within the band that contains the highest level of the desired power, based on either an RF conducted or a radiated measurement, provided that the transmitter demonstrates compliance with the peak conducted power limits. If the transmitter complies with the conducted power limits based on the use of root-mean-square averaging over a time interval, as permitted under Section 5.4(4), the attenuation required shall be 30 dB instead of 20 dB. Attenuation below the general field strength limits specified in RSS-Gen is not required.</p>	<p>At least -20dBc than the limit Specified on the BOTTOM Channel</p>	<p>PASS</p>
<p>FCC requirement: In any 100 KHz Bandwidth Outside the frequency band in which the spread spectrum intentional radiator is operating, the radio frequency power that is produce by the intentional radiator shall be at least 20 dB below that in 100KHz bandwidth within the band that contains the highest level of the desired power. In addition, radiation emissions which fall in the restricted bands, as defined in §15.205(a), must also comply with the radiated emission limits specified in§15.209(a))</p> <p>IC requirement: In any 100 kHz bandwidth outside the frequency band in which the spread spectrum or digitally modulated device is operating, the RF power that is produced shall be at least 20 dB below that in the 100 kHz bandwidth within the band that contains the highest level of the desired power, based on either an RF conducted or a radiated measurement, provided that the transmitter demonstrates compliance with the peak conducted power limits. If the transmitter complies with the conducted power limits based on the use of root-mean-square averaging over a time interval, as permitted under Section 5.4(4), the attenuation required shall be 30 dB instead of 20 dB. Attenuation below the general field strength limits specified in RSS-Gen is not required.</p>	<p>At least -20dBc than the limit Specified on the TOP Channel</p>	<p>PASS</p>



6. RADIATED EMISSION

6.1. TEST LIMIT

Frequency (MHz)	Distance Meters	Field Strengths Limit	
		μ V/m	dB(μ V)/m
0.009 ~ 0.490	300	2400/F(kHz)	---
0.490 ~ 1.705	30	24000/F(kHz)	---
1.705 ~ 30	30	30	---
30 ~ 88	3	100	40.0
88 ~ 216	3	150	43.5
216 ~ 960	3	200	46.0
960 ~ 1000	3	500	54.0
Above 1000	3	Other:74.0 dB(μ V)/m (Peak) 54.0 dB(μ V)/m (Average)	

Remark: (1) Emission level dB μ V = 20 log Emission level μ V/m
(2) The smaller limit shall apply at the cross point between two frequency bands.
(3) Distance is the distance in meters between the measuring instrument, antenna and the closest point of any part of the device or system.

6.2. MEASUREMENT PROCEDURE

1. The measuring distance of 3m shall be used for measurements. The EUT was placed on the top of a rotating table 0.8 meter above the ground at a 3 meter semi-anechoic chamber. The table was rotated 360 degrees to determine the position of the highest radiation(Below 1GHz)
2. The measuring distance of 3m shall used for measurements. The EUT was placed on the top of a rotating table 1.5 meter above the ground at a 3 meter semi-anechoic chamber. The table was rotated 360 degrees to determine the position of the highest radiation(Above 1GHz)
3. The height of the test antenna shall vary between 1m to 4m.Both horizontal and vertical polarization Of the antenna are set to make the measurement.
4. The initial step in collecting radiated emission data is a receive peak detector mode. Pre-scanning the measurement frequency range. Significant peaks are then marked and then Quasi Peak detector mode re-measured.
5. All readings are peak unless otherwise stated QP in column of Note. Peak denoted that the Peak reading compliance with the QP limits and then QP Mode measurement didn't perform(Below 1GHz)
- 6.All readings are Peak mode value unless otherwise stated AVG in column of Note. If the Peak mode measured value compliance with the Peak limits and lower than AVG Limits, the EUT shall be deemed to meet Peak&AVG limits and then only Peak mode was measured, but AVG mode didn't perform.(Above 1GHz)



The following table is the setting of spectrum analyzer and receiver.

Spectrum Parameter	Setting
Start ~Stop Frequency	9KHz~150KHz/RB 200Hz for QP
Start ~Stop Frequency	150KHz~30MHz/RB 9KHz for QP
Start ~Stop Frequency	30MHz~1000MHz/RB 120KHz for QP
Start ~Stop Frequency	1GHz~26.5GHz RBW 1MHz/ VBW 3MHz for Peak RBW 1MHz/ VBW 3MHz for Average

Receiver Parameter	Setting
Start ~Stop Frequency	9KHz~150KHz/RB 200Hz for QP
Start ~Stop Frequency	150KHz~30MHz/RB 9KHz for QP
Start ~Stop Frequency	30MHz~1000MHz/RB 120KHz for QP



6.3. TEST SETUP

RADIATED EMISSION TEST SETUP BELOW 30MHz

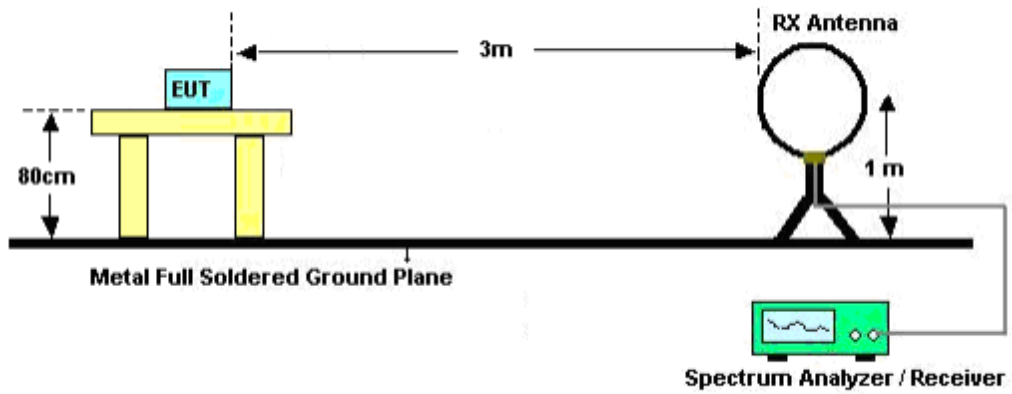

RADIATED EMISSION TEST SETUP 30MHz-1000MHz

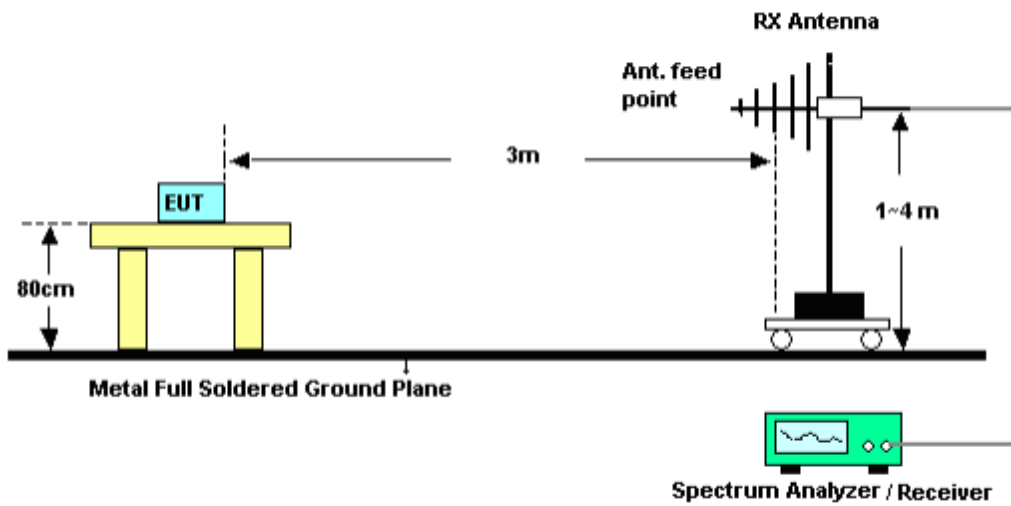



RADIATED EMISSION TEST SETUP ABOVE 1000MHz

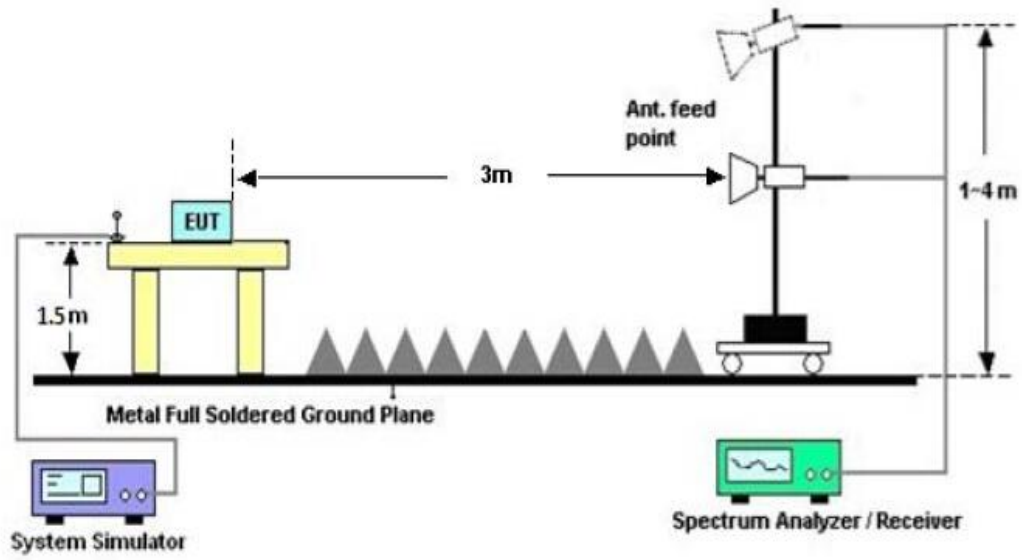



6.4. TEST RESULT

Note: All modes were tested for restricted band radiated emission, the test records reported below are the worst result worst modulation $\pi/4$ -DQPSK.

RADIATED EMISSION BELOW 30MHz

No emission found between lowest internal used/generated frequencies to 30MHz.

RADIATED EMISSION BELOW 1GHz

RADIATED EMISSION TEST- (30MHz-1GHz)-LOW CHANNEL-HORIZONTAL

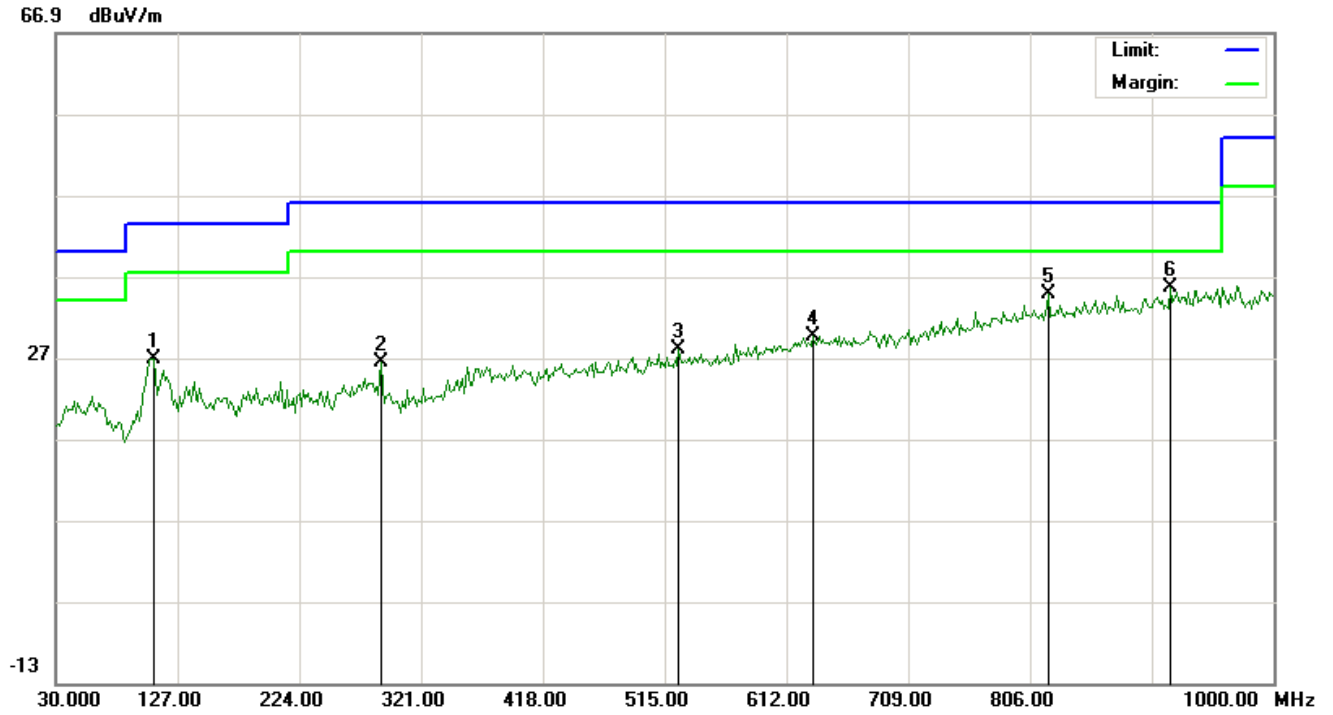

No.	Mk	Freq.	Reading	Factor	Measurement	Limit	Over	Detector	Antenna	Table	Comment
		MHz	dBuV	dB/m	dBuV/m	dBuV/m	dB		Height	Degree	
									cm	degree	
1		107.6000	10.09	16.75	26.84	43.50	-16.66	peak			
2		288.6667	6.58	19.74	26.32	46.00	-19.68	peak			
3		526.3167	2.54	25.51	28.05	46.00	-17.95	peak			
4		633.0167	2.23	27.35	29.58	46.00	-16.42	peak			
5		820.5500	4.09	30.68	34.77	46.00	-11.23	peak			
6	*	917.5500	3.69	31.85	35.54	46.00	-10.46	peak			

RESULT: PASS



RADIATED EMISSION TEST - (30MHz-1GHz)-LOW CHANNEL -VERTICAL

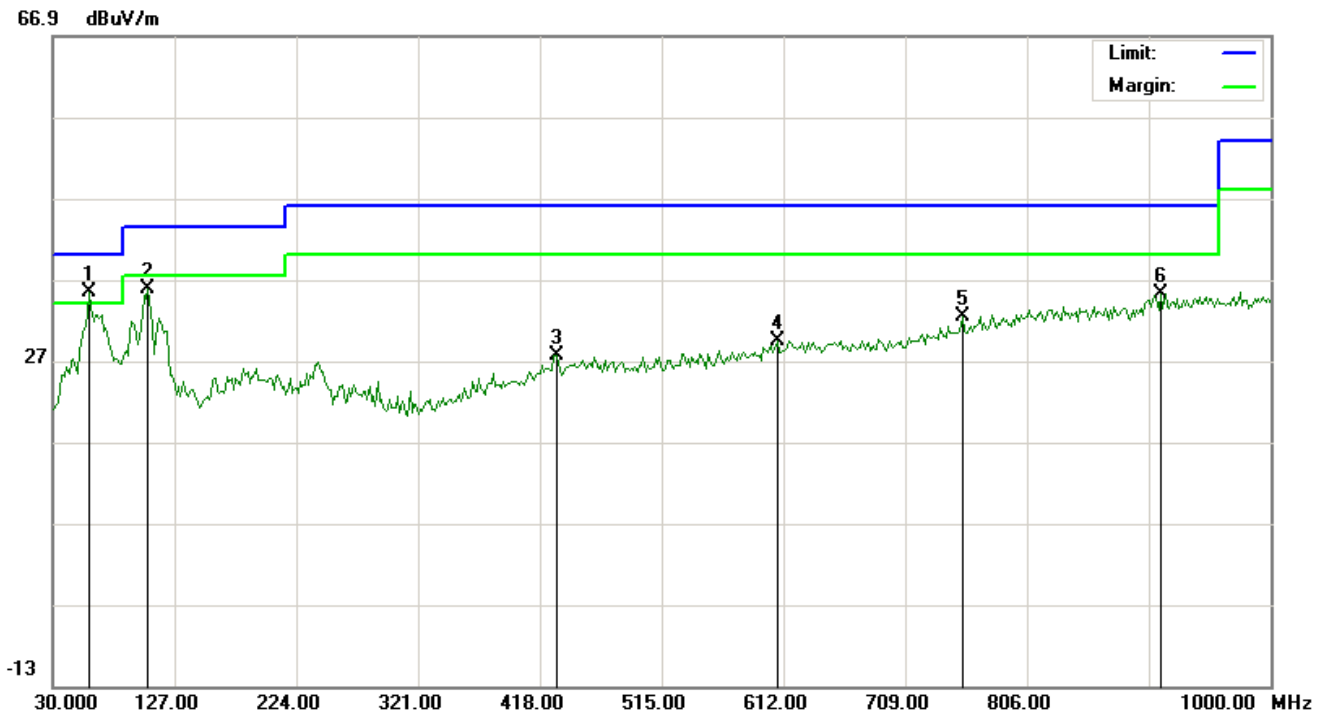

No.	Mk	Freq.	Reading	Factor	Measurement	Limit	Over	Detector	Antenna Height	Table Degree	Comment
		MHz	dBuV	dB/m	dBuV/m	dBuV/m	dB		cm	degree	
1	*	59.1000	16.43	18.95	35.38	40.00	-4.62	peak			
2		105.9833	19.15	16.60	35.75	43.50	-7.75	peak			
3		430.9333	3.96	23.60	27.56	46.00	-18.44	peak			
4		607.1500	2.39	27.04	29.43	46.00	-16.57	peak			
5		754.2667	3.04	29.38	32.42	46.00	-13.58	peak			
6		912.7000	3.36	31.81	35.17	46.00	-10.83	peak			

RESULT: PASS

Note: 1. Factor=Antenna Factor+ Cable loss, Margin=Measurement-Limit.

2. The "Factor" value can be calculated automatically by software of measurement system.

**RADIATED EMISSION ABOVE 1GHz****FIELD STRENGTH OF FUNDAMENTAL FOR BR/EDR**

EUT :	Soundcore Ace A1	Model Name. :	A3151
Temperature :	20 °C	Relative Humidity :	48%
Pressure :	1010 hPa	Test Voltage :	DC 3.7V
Test Modulation :	GFSK	Polarization :	Horizontal

Frequency (MHz)	Meter Reading (dB μ V)	Factor (dB)	Emission Level (dB μ V/m)	Limits (dB μ V/m)	Margin (dB)	Value Type
2402.021	80.03	13.46	93.49	114.00	-20.51	peak
2402.021	74.10	13.46	87.56	94.00	-6.44	AVG
2441.021	79.63	13.88	93.51	114.00	-20.49	peak
2441.021	71.67	13.88	85.55	94.00	-8.45	AVG
2480.021	78.75	14.11	92.86	114.00	-21.14	peak
2480.021	70.85	14.11	84.96	94.00	-9.04	AVG

Remark:

Factor = Antenna Factor + Cable Loss – Pre-amplifier.

EUT :	Soundcore Ace A1	Model Name. :	A3151
Temperature :	20 °C	Relative Humidity :	48%
Pressure :	1010 hPa	Test Voltage :	DC 3.7V
Test Modulation :	GFSK	Polarization :	Vertical

Frequency (MHz)	Meter Reading (dB μ V)	Factor (dB)	Emission Level (dB μ V/m)	Limits (dB μ V/m)	Margin (dB)	Value Type
2402.021	79.74	13.46	93.20	114.00	-20.80	peak
2402.021	73.32	13.46	86.78	94.00	-7.22	AVG
2441.021	79.19	13.88	93.07	114.00	-20.93	peak
2441.021	71.21	13.88	85.09	94.00	-8.91	AVG
2480.021	78.26	14.11	92.37	114.00	-21.63	peak
2480.021	70.26	14.11	84.37	94.00	-9.63	AVG

Remark:

Factor = Antenna Factor + Cable Loss – Pre-amplifier.



EUT :	Soundcore Ace A1	Model Name. :	A3151
Temperature :	20 °C	Relative Humidity :	48%
Pressure :	1010 hPa	Test Voltage :	DC 3.7V
Test Modulation :	π /4-DQPSK	Polarization :	Horizontal

Frequency	Meter Reading	Factor	Emission Level	Limits	Margin	Value Type
(MHz)	(dB μ V)	(dB)	(dB μ V/m)	(dB μ V/m)	(dB)	
2402.021	80.10	13.46	93.56	114.00	-20.44	peak
2402.021	72.23	13.46	85.69	94.00	-8.31	AVG
2441.021	78.65	13.88	92.53	114.00	-21.47	peak
2441.021	70.66	13.88	84.54	94.00	-9.46	AVG
2480.021	77.77	14.11	91.88	114.00	-22.12	peak
2480.021	69.85	14.11	83.96	94.00	-10.04	AVG

Remark:

Factor = Antenna Factor + Cable Loss – Pre-amplifier.

EUT :	Soundcore Ace A1	Model Name. :	A3151
Temperature :	20 °C	Relative Humidity :	48%
Pressure :	1010 hPa	Test Voltage :	DC 3.7V
Test Modulation :	π /4-DQPSK	Polarization :	Vertical

Frequency	Meter Reading	Factor	Emission Level	Limits	Margin	Value Type
(MHz)	(dB μ V)	(dB)	(dB μ V/m)	(dB μ V/m)	(dB)	
2402.021	79.66	13.46	93.12	114.00	-20.88	peak
2402.021	71.74	13.46	85.20	94.00	-8.80	AVG
2441.021	78.21	13.88	92.09	114.00	-21.91	peak
2441.021	70.22	13.88	84.10	94.00	-9.90	AVG
2480.021	77.34	14.11	91.45	114.00	-22.55	peak
2480.021	69.28	14.11	83.39	94.00	-10.61	AVG

Remark:

Factor = Antenna Factor + Cable Loss – Pre-amplifier.



7. BAND EDGE EMISSION

7.1. MEASUREMENT PROCEDURE

1. Set the EUT Work on the top, the bottom operation frequency individually.
2. Set SPA Start or Stop Frequency=Operation Frequency,
For unrestricted band: RBW=100kHz, VBW=300kHz
For restricted band: RBW=1MHz, VBW=3*RBW
Center frequency =Operation frequency
3. The band edges was measured and recorded.

7.2. TEST SET-UP

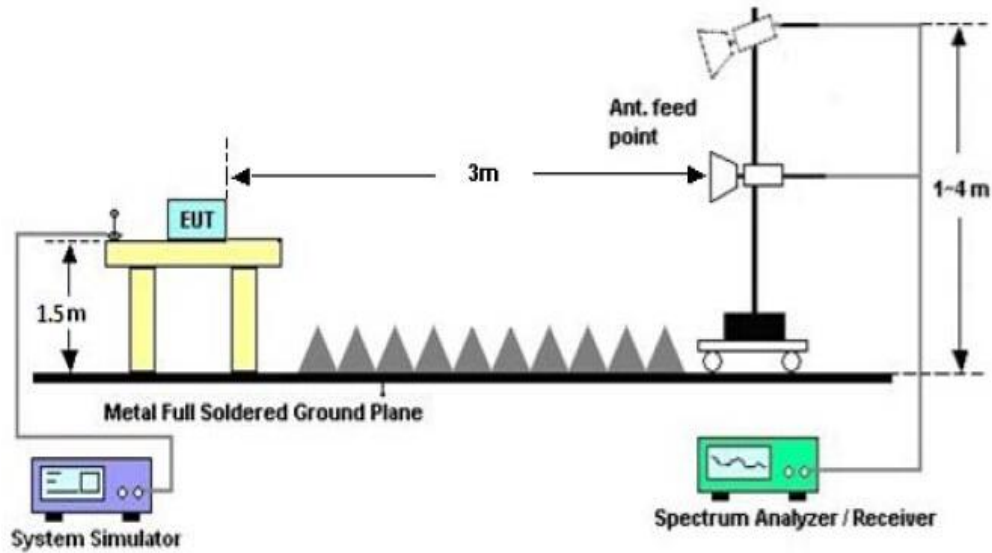



7.3. TEST RESULT

For BR/EDR

EUT :	Soundcore Ace A1	Model Name. :	A3151
Temperature :	20 °C	Relative Humidity :	48%
Pressure :	1010 hPa	Test Voltage :	DC 3.7V
Test Mode :	Mode 4	Polarization :	Horizontal

PK Value

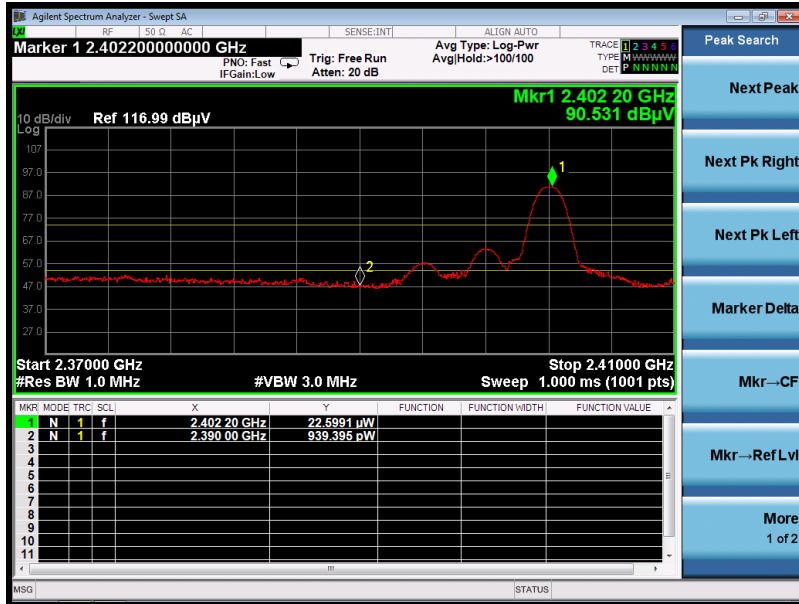

AV Value

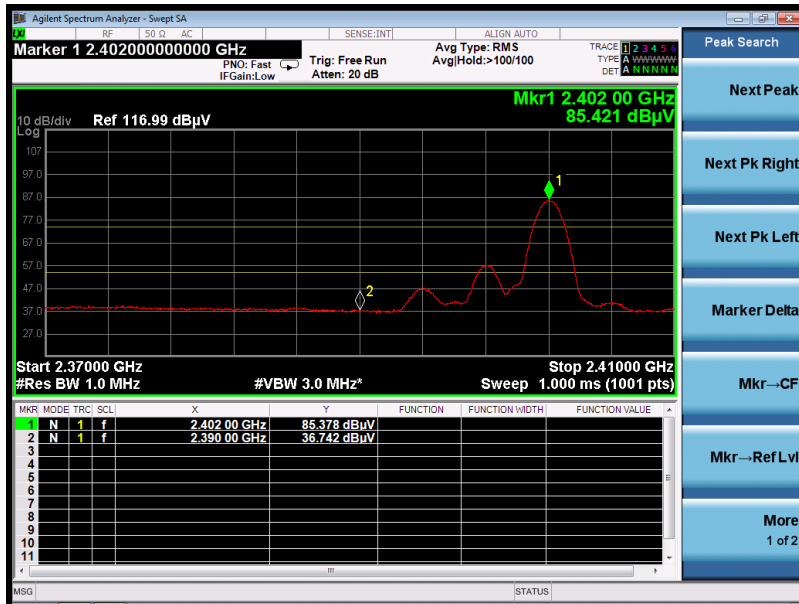



EUT :	Soundcore Ace A1	Model Name. :	A3151
Temperature :	20 °C	Relative Humidity :	48%
Pressure :	1010 hPa	Test Voltage :	DC 3.7V
Test Mode :	Mode 6	Polarization :	Horizontal

PK Value

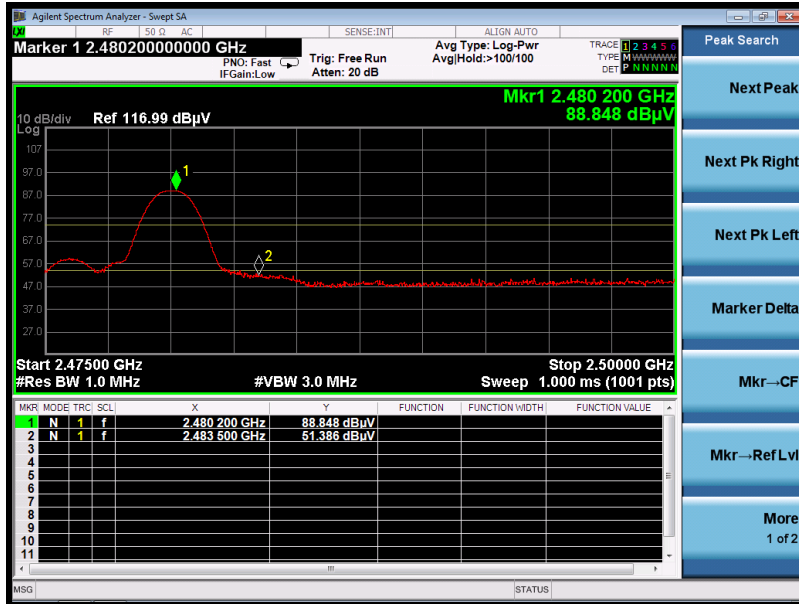

AV Value





EUT :	Soundcore Ace A1	Model Name. :	A3151
Temperature :	20 °C	Relative Humidity :	48%
Pressure :	1010 hPa	Test Voltage :	DC 3.7V
Test Mode :	Mode 6	Polarization :	Vertical

PK Value

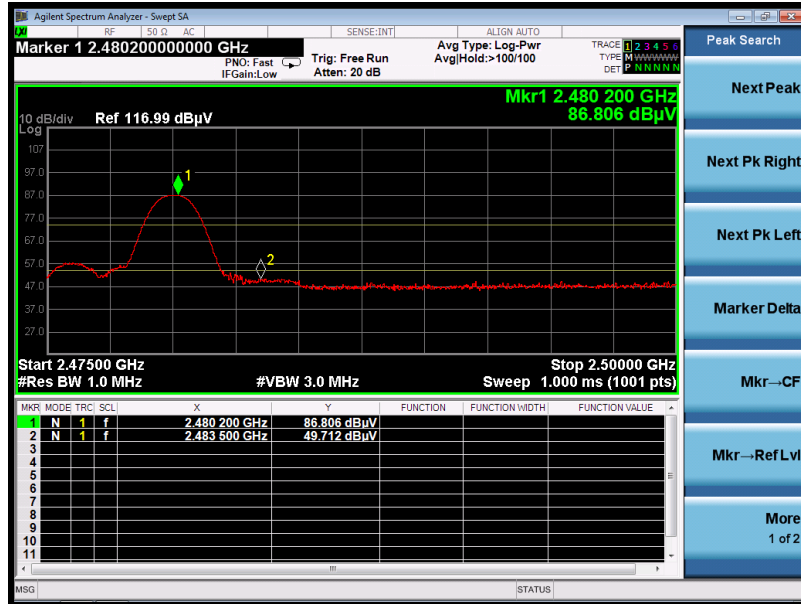

AV Value

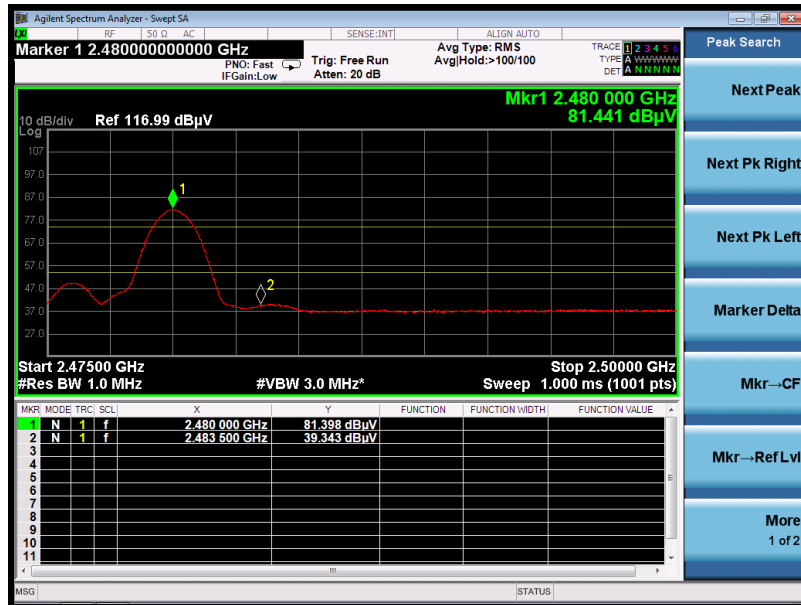

RESULT: PASS

Note: The factor had been edited in the "Input Correction" of the Spectrum Analyzer. So the Amplitude of test plots is equal to Reading level plus the Factor in dB. Use the A dB(μV) to represent the Amplitude. Use the F dB(μV/m) to represent the Field Strength. So A=F. All test modes had been pre-tested. The π/4-DQPSK modulation is the worst case and recorded in the report.



9. TIME OF OCCUPANCY (DWELL TIME)

9.1. MEASUREMENT PROCEDURE

1. Place the EUT on the table and set it in transmitting mode
2. Remove the antenna from the EUT and then connect a low RF cable from the antenna port to the spectrum analyzer.
3. Set Span = zero span, centered on a hopping channel
4. Set the spectrum analyzer as RBW=1MHz, VBW>=RBW, Span = 0 Hz

9.2. TEST SETUP (BLOCK DIAGRAM OF CONFIGURATION)

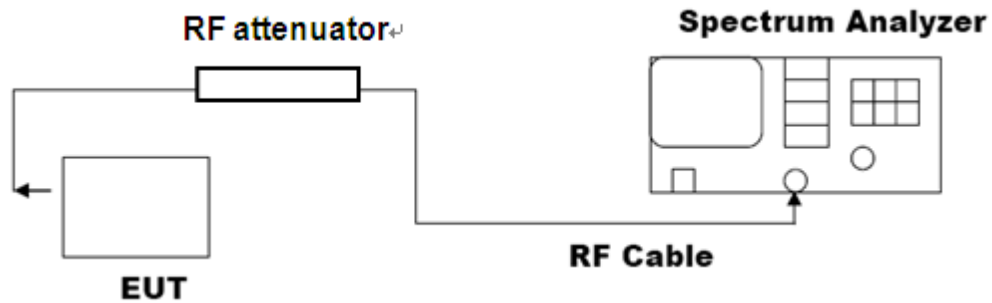

9.3. LIMITS AND MEASUREMENT RESULT

The Worst Case (2Mbps)

Channel	Time of Pulse for DH5 (ms)	Period Time (s)	Sweep Time (ms)	Limit (ms)
Low	2.900	31.6	309.33	400
Middle	2.907	31.6	311.15	400
High	2.917	31.6	311.15	400

Low Channel Time

$$2.900 * (1600/6) / 79 * 31.6 = 309.33 \text{ms}$$

Middle Channel Time

$$2.917 * (1600/6) / 79 * 31.6 = 311.15 \text{ms}$$

High Channel Time

$$2.917 * (1600/6) / 79 * 31.6 = 311.15 \text{ms}$$



10. FREQUENCY SEPARATION

10.1. MEASUREMENT PROCEDURE

1. Place the EUT on the table and set it in transmitting mode
2. Remove the antenna from the EUT and then connect a low RF cable from the antenna port to the spectrum analyzer
3. Set Span = wide enough to capture the peaks of two adjacent channels Resolution (or IF) Bandwidth (RBW) \geq 1% of the span Video (or Average) Bandwidth (VBW) \geq RBW; Sweep = auto; Detector function = peak; Trace = max hold

10.2. TEST SETUP (BLOCK DIAGRAM OF CONFIGURATION)

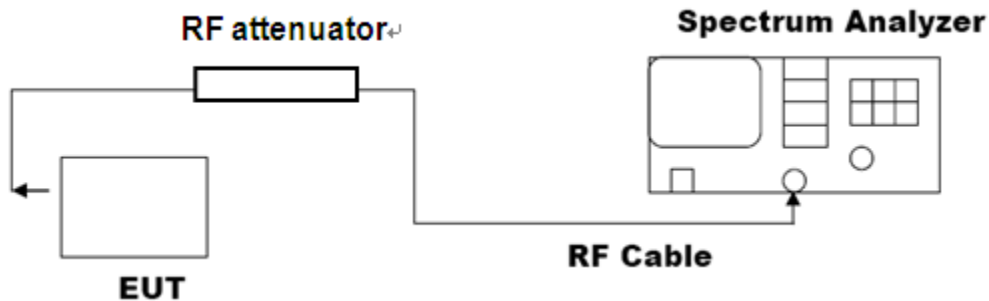

10.3. LIMITS AND MEASUREMENT RESULT

CHANNEL	CHANNEL SEPARATION	LIMIT	RESULT
	KHz	KHz	
CH00-CH01	1000	\geq 25 KHz or 2/3 20 dB BW	Pass

TEST PLOT FOR FREQUENCY SEPARATION (3Mbps)

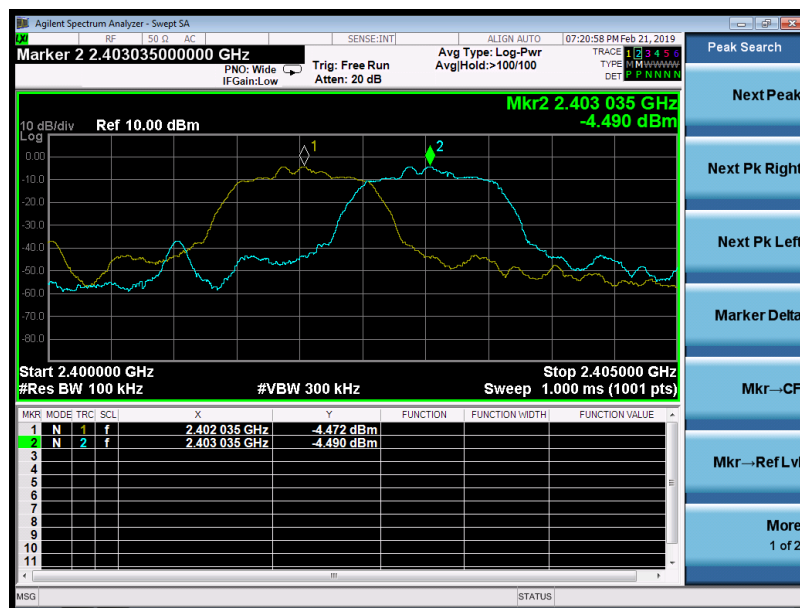



11. LINE CONDUCTED EMISSION TEST

11.1. LIMITS OF LINE CONDUCTED EMISSION TEST

Frequency	Maximum RF Line Voltage	
	Q.P.(dBuV)	Average(dBuV)
150kHz~500kHz	66-56	56-46
500kHz~5MHz	56	46
5MHz~30MHz	60	50

Note:

1. The lower limit shall apply at the transition frequency.
2. The limit decreases linearly with the logarithm of the frequency in the range 0.15 MHz to 0.50 MHz.

11.2. BLOCK DIAGRAM OF LINE CONDUCTED EMISSION TEST

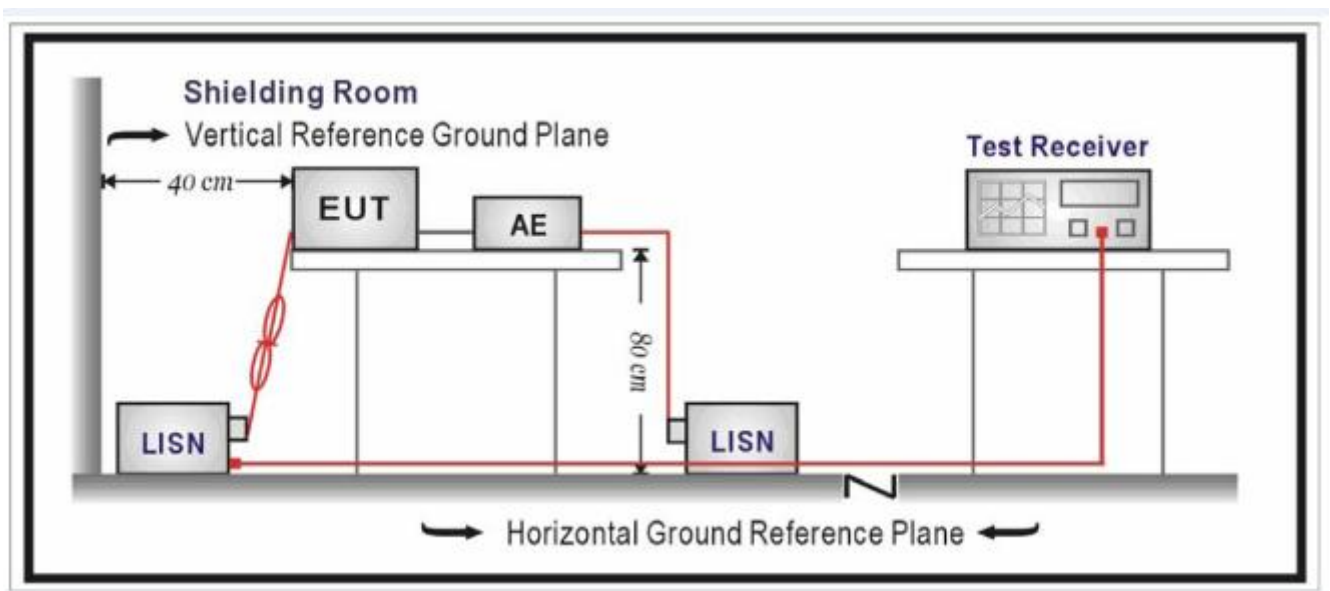



11.3. PRELIMINARY PROCEDURE OF LINE CONDUCTED EMISSION TEST

1. The equipment was set up as per the test configuration to simulate typical actual usage per the user's manual. When the EUT is a tabletop system, a wooden table with a height of 0.8 meters is used and is placed on the ground plane as per ANSI C63.10, RSS-GEN (see Test Facility for the dimensions of the ground plane used). When the EUT is a floor-standing equipment, it is placed on the ground plane which has a 3-12 mm non-conductive covering to insulate the EUT from the ground plane.
2. Support equipment, if needed, was placed as per ANSI C63.10, RSS-GEN.
3. All I/O cables were positioned to simulate typical actual usage as per ANSI C63.10, RSS-GEN.
4. All support equipments received AC120V/60Hz power from a LISN, if any.
5. The EUT received DC charging voltage by adapter which received 120V/60Hz power by a LISN.
6. The test program was started. Emissions were measured on each current carrying line of the EUT using a spectrum Analyzer / Receiver connected to the LISN powering the EUT. The LISN has two monitoring points: Line 1 (Hot Side) and Line 2 (Neutral Side). Two scans were taken: one with Line 1 connected to Analyzer / Receiver and Line 2 connected to a 50 ohm load; the second scan had Line 1 connected to a 50 ohm load and Line 2 connected to the Analyzer / Receiver.
7. Analyzer / Receiver scanned from 150 kHz to 30MHz for emissions in each of the test modes.
8. During the above scans, the emissions were maximized by cable manipulation.
9. The test mode(s) were scanned during the preliminary test.

Then, the EUT configuration and cable configuration of the above highest emission level were recorded for reference of final testing.

11.4. FINAL PROCEDURE OF LINE CONDUCTED EMISSION TEST

1. EUT and support equipment was set up on the test bench as per step 2 of the preliminary test.
2. A scan was taken on both power lines, Line 1 and Line 2, recording at least the six highest emissions. Emission frequency and amplitude were recorded into a computer in which correction factors were used to calculate the emission level and compare reading to the applicable limit. If EUT emission level was less -2dB to the A.V. limit in Peak mode, then the emission signal was re-checked using Q.P and Average detector.
3. The test data of the worst case condition(s) was reported on the Summary Data page.



11.5. TEST RESULT OF LINE CONDUCTED EMISSION TEST

Line Conducted Emission Test Line 1-L

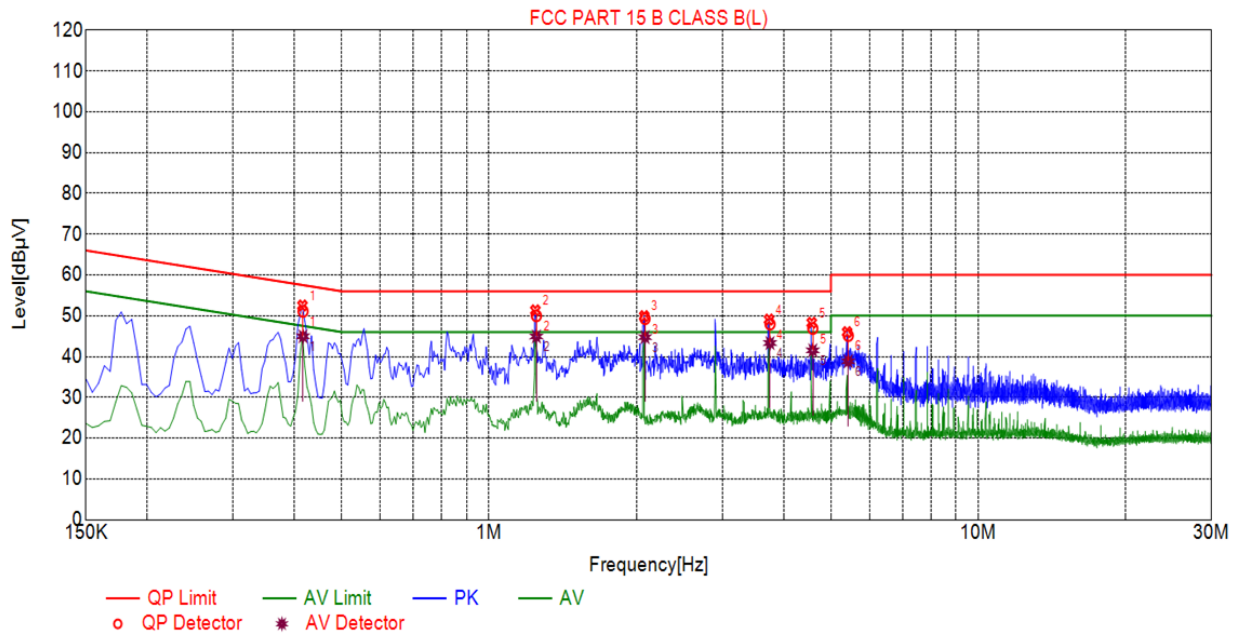

Final Data List								
NO.	Freq. [MHz]	Factor [dB]	QP Value [dBµV]	QP Limit [dBµV]	QP Margin [dB]	AV Value [dBµV]	AV Limit [dBµV]	AV Margin [dB]
1	0.4165	10.03	51.08	57.52	6.44	44.97	47.52	2.55
2	1.2495	10.09	49.99	56.00	6.01	44.93	46.00	1.07
3	2.0842	10.15	49.30	56.00	6.70	44.76	46.00	1.24
4	3.7532	10.25	47.95	56.00	8.05	43.32	46.00	2.68
5	4.5903	10.25	46.88	56.00	9.12	41.52	46.00	4.48
6	5.4253	10.26	45.15	60.00	14.85	38.84	50.00	11.16



Line Conducted Emission Test Line 2-N

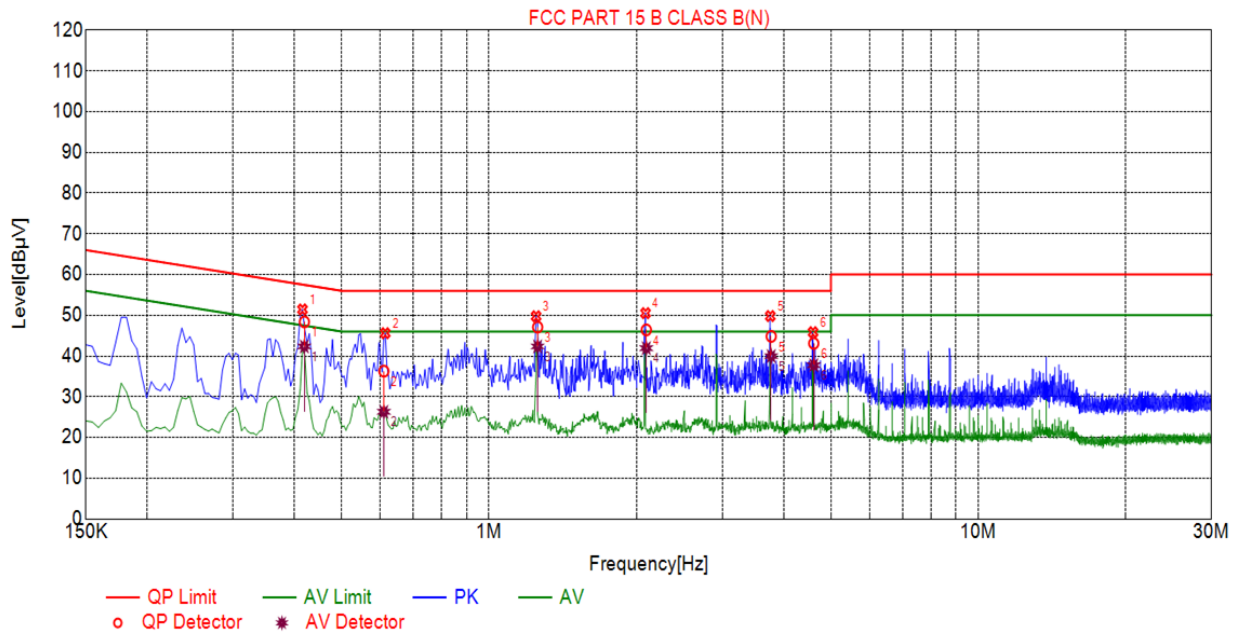

Final Data List								
NO.	Freq. [MHz]	Factor [dB]	QP Value [dBµV]	QP Limit [dBµV]	QP Margin [dB]	AV Value [dBµV]	AV Limit [dBµV]	AV Margin [dB]
1	0.4191	10.04	48.39	57.47	9.08	42.35	47.47	5.12
2	0.6094	10.05	36.29	56.00	19.71	26.31	46.00	19.69
3	1.2567	10.09	47.09	56.00	8.91	42.36	46.00	3.64
4	2.0965	10.15	46.42	56.00	9.58	41.93	46.00	4.07
5	3.7745	10.25	44.83	56.00	11.17	39.98	46.00	6.02
6	4.6108	10.26	43.10	56.00	12.90	37.75	46.00	8.25



12. ANTENNA REQUIREMENT

Standard Applicable

For intentional device, according to FCC 47 CFR Section 15.203 and RSS-GEN, an intentional radiator shall be designed to ensure that no antenna other than that furnished by the responsible party shall be used with the device.

Refer to statement below for compliance.

The device has a fixed antenna, full with the requirement of this part.



APPENDIX A: PHOTOGRAPHS OF TEST SETUP

Refer to Attached file(appendix I)

APPENDIX B: PHOTOGRAPHS OF EUT

Refer to Attached file(appendix I)

----END OF REPORT----