

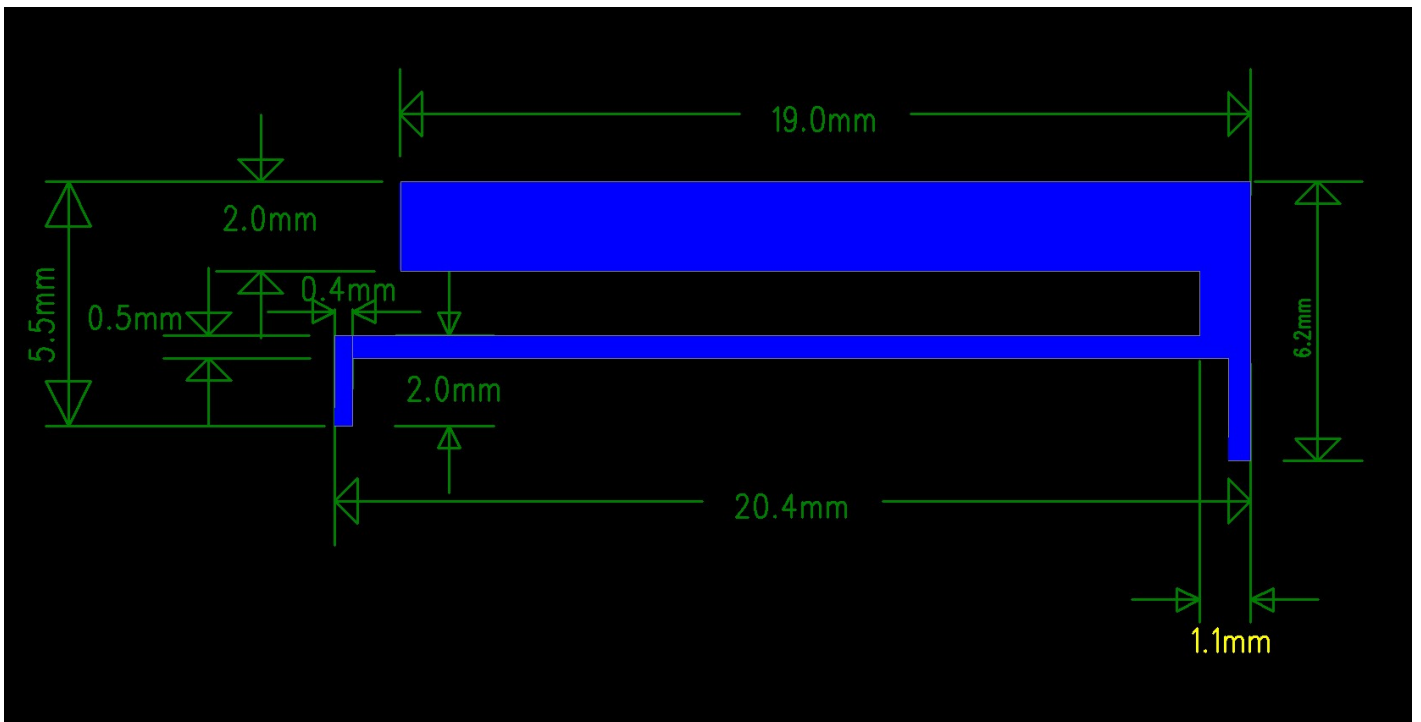

3.Product graph





4. Network analyzer graph

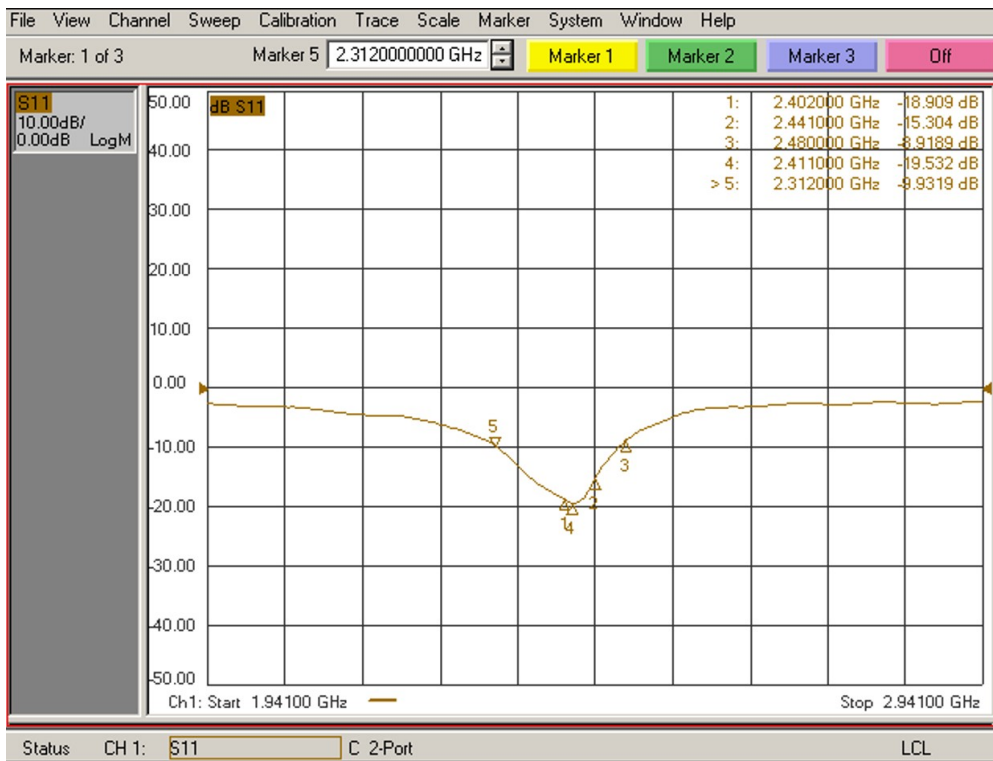
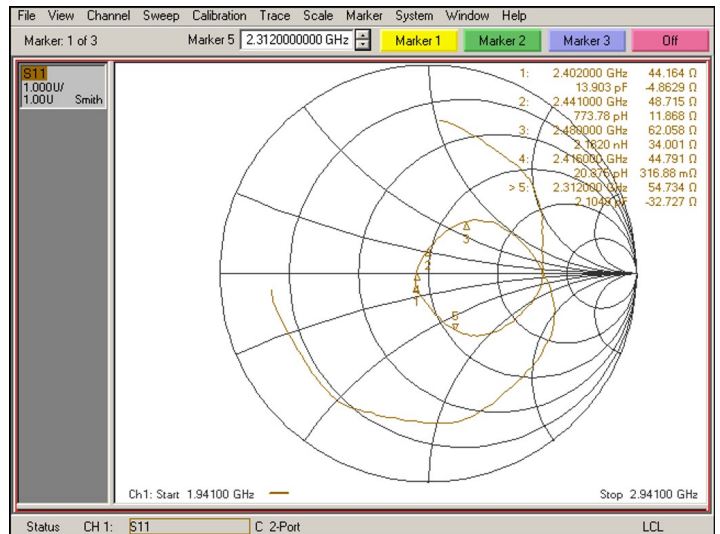



5. Efficiency and Gain test results

Frequency: 2.40-2.480GHz (Free)			
Frequency Point (MHz)	Efficiency (%)	Efficiency (dB)	Gain (dBi)
2400	61.10	-2.14	1.69
2410	59.40	-2.26	1.42
2420	57.57	-2.40	1.19
2430	55.34	-2.57	1.01
2440	53.46	-2.72	0.83
2450	50.93	-2.93	0.60
2460	48.54	-3.14	0.41
2470	46.54	-3.32	0.25
2480	44.36	-3.53	0.07
Mean value	50.03	-2.78	0.83



6. Radiation pattern

3D Diagram 2.450GHz (Free) ---dBi

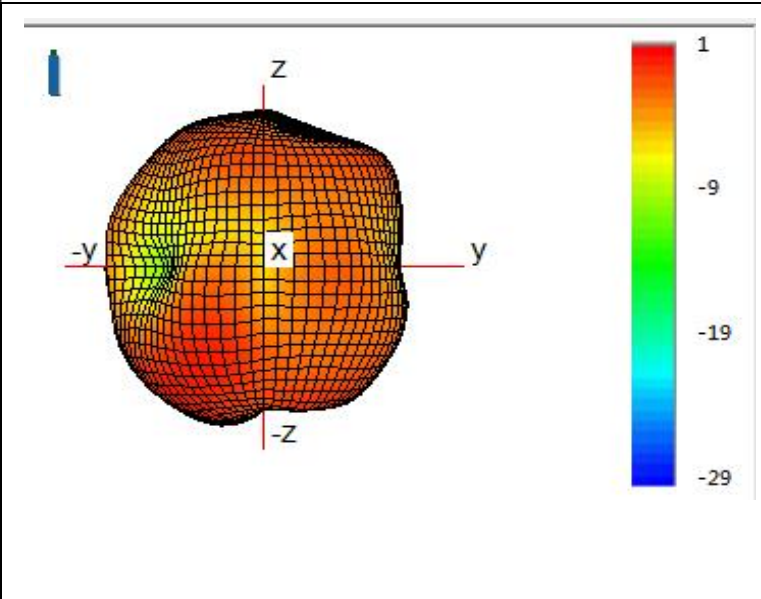
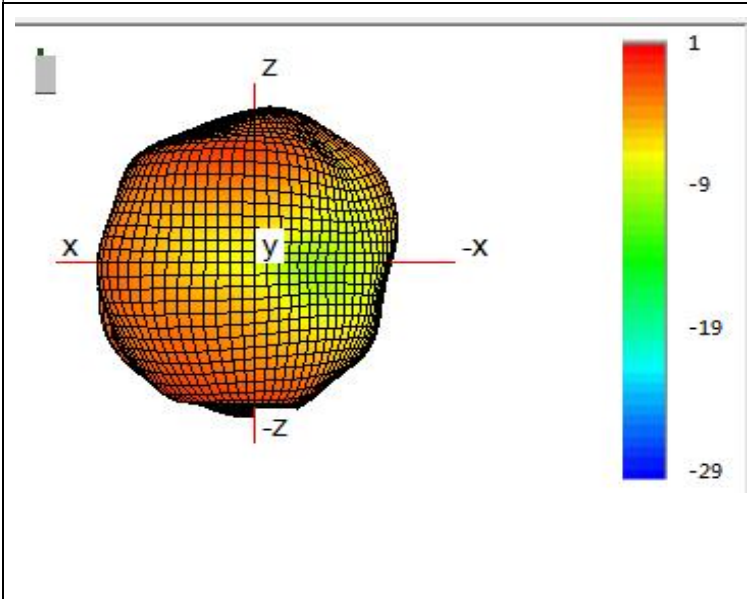
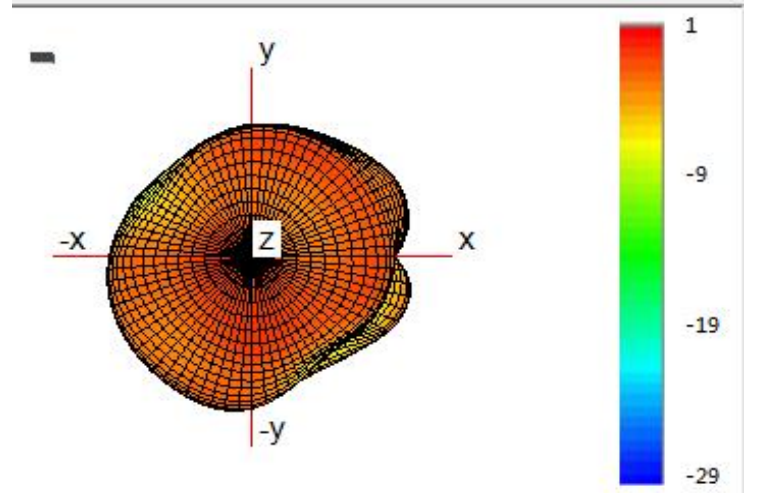
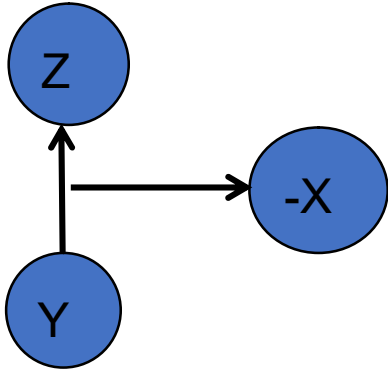



Shenzhen Boomtech Industry Co., Ltd.

2D Diagram 2.450GHz (Free) ---dBi

