

FCC Test Report

Report No.: AGC01110190219FE08

FCC ID : 2A0KB-A3024
IC : 23451-A3024
APPLICATION PURPOSE : Original Equipment
PRODUCT DESIGNATION : Soundcore Life 2 NC
BRAND NAME : Soundcore
MODEL NAME : A3024
CLIENT : Anker Innovations Limited
DATE OF ISSUE : Mar. 28, 2019
STANDARD(S) : FCC Part 15 Subpart C Section 15.247, ANSI C63.10: 2013
: RSS-GEN: Issue 5, RSS-247: Issue 2
REPORT VERSION : V1.1

Attestation of Global Compliance (Shenzhen) Co., Ltd

CAUTION:

This report shall not be reproduced except in full without the written permission of the test laboratory and shall not be quoted out of context.

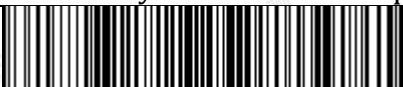

The results shown in this test report refer only to the sample(s) tested unless otherwise stated and the sample(s) are retained for 30 days only. The document is issued by AGC, this document cannot be reproduced except in full with our prior written permission. The more details and the authenticity of the report will be confirmed at <http://www.agc-cert.com>.

Report Revise Record

Report Version	Revise Time	Issued Date	Valid Version	Notes
V1.0	/	Mar. 22, 2019	Invalid	Initial release
V1.1	1st	Mar. 28, 2019	Valid	Revise report

The results shown in this test report refer only to the sample(s) tested unless otherwise stated and the sample(s) are retained for 30 days only. The document is issued by AGC, this document cannot be reproduced except in full with our prior written permission. The more details and the authenticity of the report will be confirmed at <http://www.agc-cert.com>.

TABLE OF CONTENTS

1. VERIFICATION OF COMPLIANCE..... **5**

2. GENERAL INFORMATION **6**

 2.1 PRODUCT DESCRIPTION 6

 2.2 TEST METHOD 6

 2.3 EQUIPMENT MODIFICATIONS 6

 2.4 MEASUREMENT UNCERTAINTY 6

3. SYSTEM TEST CONFIGURATION **7**

 3.1 CONFIGURATION OF TESTED SYSTEM 7

 3.2 EQUIPMENT USED IN TESTED SYSTEM 7

 3.3. SUMMARY OF TEST RESULTS 8

4. DESCRIPTION OF TEST MODES **9**

5. TEST FACILITY **10**

6. TEST EQUIPMENT LIST **11**

7. ANTENNA REQUIREMENT **12**

 7.1. STANDARD APPLICABLE 12

 7.2. TEST RESULT 12

8. RADIATED EMISSION **13**

 8.1 LIMITS 13

 8.2 MEASUREMENT PROCEDURE 13

 8.3 TEST SETUP 14

 8.4 TEST RESULT 16

9. BAND EDGE EMISSION **21**

 9.1. MEASUREMENT PROCEDURE 21

 9.2. TEST SET-UP 21

 9.3. TEST RESULT 22

10. 6DB BANDWIDTH **26**

 10.1. TEST PROCEDURE 26

 10.2. SUMMARY OF TEST RESULTS/PLOTS 26

11. CONDUCTED OUTPUT POWER **28**

 11.1. MEASUREMENT PROCEDURE 28

 11.2. TEST SET-UP (BLOCK DIAGRAM OF CONFIGURATION) 28

 11.3. LIMITS AND MEASUREMENT RESULT 29

The results shown in this test report refer only to the sample(s) tested unless otherwise stated and the sample(s) are retained for 30 days only. The document is issued by AGC, this document cannot be reproduced except in full with our prior written permission. The more details and the authenticity of the report will be confirmed at <http://www.agc-cert.com>.

12. CONDUCTED SPURIOUS EMISSION.....	31
12.1. MEASUREMENT PROCEDURE	31
12.2. TEST SET-UP (BLOCK DIAGRAM OF CONFIGURATION)	31
12.3. LIMITS AND MEASUREMENT RESULT	31
13. CONDUCTED OUTPUT POWER SPECTRAL DENSITY	36
13.1 MEASUREMENT PROCEDURE	36
13.2 TEST SET-UP (BLOCK DIAGRAM OF CONFIGURATION)	36
13.3 LIMITS AND MEASUREMENT RESULT	36
.....	38
14. LINE CONDUCTED EMISSION TEST	39
14.1 LIMITS	39
14.2 TEST SETUP.....	39
14.3 PRELIMINARY PROCEDURE	40
14.4 FINAL TEST PROCEDURE	40
14.5 TEST RESULT OF POWER LINE.....	40
APPENDIX A: PHOTOGRAPHS OF TEST SETUP	41
APPENDIX B: PHOTOGRAPHS OF EUT.....	41

The results shown in this test report refer only to the sample(s) tested unless otherwise stated and the sample(s) are retained for 30 days only. The document is issued by AGC, this document cannot be reproduced except in full with our prior written permission. The more details and the authenticity of the report will be confirmed at <http://www.agc-cert.com>.



1. VERIFICATION OF COMPLIANCE

Applicant	Anker Innovations Limited
Address	Room 1318-19, Hollywood Plaza, 610 Nathan Road, Mongkok, Kowloon, Hongkong
Manufacturer	Anker Innovations Limited
Address	Room 1318-19, Hollywood Plaza, 610 Nathan Road, Mongkok, Kowloon, Hongkong
Factory	TCL Technoly Electronics(Huizhou) Co., Ltd
Address	Section 37, Zhongkai High-tech Development Zone, Huizhou City, Guangdong Province, P.R.China
Product Designation	Soundcore Life 2 NC
Brand Name	Soundcore
Test Model	A3024
Date of test	Feb. 28, 2019 to Mar. 28, 2019
Deviation	None
Condition of Test Sample	Normal
Report Template	AGCRT-US-BLE/RF (2013-03-01)

We hereby certify that:

The above equipment was tested by Attestation of Global Compliance (Shenzhen) Co., Ltd. The test data, the energy emitted by the sample tested as described in this report is in compliance with the requirements of FCC Rules Part 15.247. The test results of this report relate only to the tested sample identified in this report.

Tested By



John Zeng(Zeng Weiqiang) Mar. 28, 2019

Reviewed By

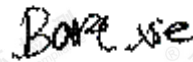

Bart Xie(Xie Xiaobin) Mar. 28, 2019

Approved By



Forrest Lei(Lei Yonggang)
 Authorized Officer Mar. 28, 2019

The results shown in this test report refer only to the sample(s) tested unless otherwise stated and the sample(s) are retained for 30 days only. The document is issued by AGC, this document cannot be reproduced except in full with our prior written permission. The more details and the authenticity of the report will be confirmed at <http://www.agc-cert.com>.

2.GENERAL INFORMATION

2.1PRODUCT DESCRIPTION

The EUT is designed as a "Soundcore Life 2 NC". It is designed by way of utilizing the FHSS technology to achieve the system operation.

A major technical description of EUT is described as following

Operation Frequency	2.402 GHz to 2.480GHz
RF Output Power	0.973dBm(Max)
Bluetooth Version	V5.0
Modulation (BLE)	GFSK for BLE
Number of channels	40 Channel(37 Hopping Channel,3 advertising Channel)
Antenna Designation	PCB Antenna
Antenna Gain	1.6dBi
Hardware Version	40-AK3024-MAE4G
Software Version	V1.06
Power Supply	DC 3.7V by battery
Note: 1. The USB port only used for charging and can't be used to transfer data with PC. 2. The BT function of EUT didn't work when charging.	

2.2TEST METHOD

All measurements contained in this report were conducted with ANSI C63.10-2013.

2.3 EQUIPMENT MODIFICATIONS

Not available for this EUT intended for grant.

2.4 MEASUREMENT UNCERTAINTY

The reported uncertainty of measurement $y \pm U$, where expanded uncertainty U is based on a standard uncertainty multiplied by a coverage factor of $k=2$, providing a level of confidence of approximately 95%.

- Uncertainty of Conducted Emission, $U_c = \pm 3.2$ dB
- Uncertainty of Radiated Emission below 1GHz, $U_c = \pm 3.9$ dB
- Uncertainty of Radiated Emission above 1GHz, $U_c = \pm 4.8$ dB
- Uncertainty of Conducted Band Edges, $U_c = \pm 1.5$ dB
- Uncertainty of Radiated Band Edges, $U_c = \pm 4.8$ dB
- Uncertainty of 6 dB Bandwidth, $U_c = \pm 1.5$ dB
- Uncertainty of Conducted Output Power, $U_c = \pm 1.5$ dB
- Uncertainty of Conducted Spurious Emission, $U_c = \pm 1.5$ dB
- Uncertainty of Conducted Power Spectral Density, $U_c = \pm 1.5$ dB

The results shown in this test report refer only to the sample(s) tested unless otherwise stated and the sample(s) are retained for 30 days only. The document is issued by AGC, this document cannot be reproduced except in full with our prior written permission. The more details and the authenticity of the report will be confirmed at <http://www.agc-cert.com>.

3. SYSTEM TEST CONFIGURATION

3.1 CONFIGURATION OF TESTED SYSTEM

Configure 1: (Normal hopping)



Configuration: Continuous TX

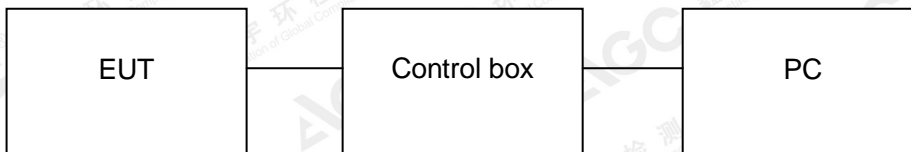

3.2 EQUIPMENT USED IN TESTED SYSTEM

Item	Equipment	Mfr/Brand	Model/Type No.	Remark
1	Soundcore Life 2 NC	Soundcore	A3024	EUT
2	battery	VDL	902532	Accessory
3	PC	APPLE	A1465	A.E
4	IPOD	APPLE	A1367	A.E
5	Control box	GZUT	USB_TTL	A.E
6	USB Cable	N/A	N/A	A.E
7	PC	DELL	OPTIPLEX 380	A.E.

The results shown in this test report refer only to the sample(s) tested unless otherwise stated and the sample(s) are retained for 30 days only. The document is issued by AGC, this document cannot be reproduced except in full with our prior written permission. The more details and the authenticity of the report will be confirmed at <http://www.agc-cert.com>.

3.3. SUMMARY OF TEST RESULTS

FCC RULES	DESCRIPTION OF TEST	RESULT
§15.203, §RSS-Gen 6.8	Antenna Requirement	Compliant
§15.209 §15.247(d), §RSS-Gen 8.9	Radiated Emission	Compliant
§15.247(d), §RSS-Gen 8.10	Band Edges	Compliant
§15.247(a) (2), §RSS 247 5.2 (a) §RSS-Gen 4.6	6 dB Bandwidth	Compliant
§15.247(b) §RSS 247 5.4 (d)	Conducted Output Power	Compliant
§15.247(d), §RSS 247 5.5	Conducted Spurious Emission	Compliant
§15.247(e), §RSS 247 5.2 (b)	Conducted Power Spectral Density	Compliant
§15.207, §RSS-Gen 8.8	Line Conduction Emission	N/A

Note: N/A means it's not applicable to this item.

The results shown in this test report refer only to the sample(s) tested unless otherwise stated and the sample(s) are retained for 30 days only. The document is issued by AGC, this document cannot be reproduced except in full with our prior written permission. The more details and the authenticity of the report will be confirmed at <http://www.agc-cert.com>.

4. DESCRIPTION OF TEST MODES

The EUT has been operated in one modulation: GFSK.

NO.	TEST MODE DESCRIPTION
1	Low channel GFSK
2	Middle channel GFSK
3	High channel GFSK
4	BT Link

- Note: 1. Only the result of the worst case was recorded in the report if no any records.
 2. For Radiated Emission, 3axis were chosen for testing for each applicable mode.
 3. Transmitting duty cycle >98%, The average correction factor is about -0.18
 4. The EUT used fully-charged battery when tested.

The results shown in this test report refer only to the sample(s) tested unless otherwise stated and the sample(s) are retained for 30 days only. The document is issued by AGC, this document cannot be reproduced except in full with our prior written permission. The more details and the authenticity of the report will be confirmed at <http://www.agc-cert.com>.

5. TEST FACILITY

Test Site	Attestation of Global Compliance (Shenzhen) Co., Ltd
Location	1-2/F, Building 19, Junfeng Industrial Park, Chongqing Road, Heping Community, Fuhai Street, Bao'an District, Shenzhen, Guangdong, China
Designation Number	CN1259
FCC Test Firm Registration Number	975832
A2LA Cert. No.	5054.02
Description	Attestation of Global Compliance(Shenzhen) Co., Ltd is accredited by A2LA

The results shown in this test report refer only to the sample(s) tested unless otherwise stated and the sample(s) are retained for 30 days only. The document is issued by AGC, this document cannot be reproduced except in full with our prior written permission. The more details and the authenticity of the report will be confirmed at <http://www.agc-cert.com>.

6. TEST EQUIPMENT LIST
TEST EQUIPMENT OF RADIATED EMISSION TEST

Equipment	Manufacturer	Model	S/N	Cal. Date	Cal. Due
TEST RECEIVER	R&S	ESCI	10096	Jun. 12, 2018	Jun. 11, 2019
EXA Signal Analyzer	Aglient	N9010A	MY53470504	Dec. 20, 2018	Dec. 19, 2019
2.4GHz Fliter	Micro-tronics	087	N/A	Jun. 12, 2018	Jun. 11, 2019
Attenuator	Weinachel Corp	58-30-33	N/A	Jun. 12, 2018	Jun. 11, 2019
Horn antenna	SCHWARZBECK	BBHA 9170	#768	Sep. 21, 2017	Sep. 20, 2020
Active loop antenna (9K-30MHz)	ZHINAN	ZN30900C	18051	Jun. 14, 2018	Jun. 13, 2020
Double-Ridged Waveguide Horn	ETS LINDGREN	3117	00034609	May. 26, 2018	May. 25, 2020
Broadband Preamplifier	ETS LINDGREN	3117PA	00225134	Oct. 25, 2018	Oct. 24, 2019
ANTENNA	SCHWARZBECK	VULB9168	D69250	Sep. 28, 2017	Sep. 27, 2019

The results shown in this test report refer only to the sample(s) tested unless otherwise stated and the sample(s) are retained for 30 days only. The document is issued by AGC, this document cannot be reproduced except in full with our prior written permission. The more details and the authenticity of the report will be confirmed at <http://www.agc-cert.com>.

7. ANTENNA REQUIREMENT

7.1. STANDARD APPLICABLE

According to FCC 15.203, An intentional radiator shall be designed to ensure that no antenna other than that furnished by the responsible party shall be used with the device. The use of a permanently attached antenna or of an antenna that uses a unique coupling to the intentional radiator shall be considered sufficient to comply with the provisions of this Section. The manufacturer may design the unit so that a broken antenna can be replaced by the user, but the use of a standard antenna jack or electrical connector is prohibited. This requirement does not apply to carrier current devices or to devices operated under the provisions of Sections 15.211, 15.213, 15.217, 15.219, or 15.221. Further, this requirement does not apply to intentional radiators that must be professionally installed, such as perimeter protection systems and some field disturbance sensors, or to other intentional radiators which, in accordance with Section 15.31(d), must be measured at the installation site. However, the installer shall be responsible for ensuring that the proper antenna is employed so that the limits in this Part are not exceeded.

7.2. TEST RESULT

This product has a permanent antenna, fulfill the requirement of this section.

The results shown in this test report refer only to the sample(s) tested unless otherwise stated and the sample(s) are retained for 30 days only. The document is issued by AGC, this document cannot be reproduced except in full with our prior written permission. The more details and the authenticity of the report will be confirmed at <http://www.agc-cert.com>.

8. RADIATED EMISSION

8.1 LIMITS

Frequency (MHz)	Distance Meters	Field Strengths Limit	
		μ V/m	dB(μ V)/m
0.009 ~ 0.490	300	2400/F(kHz)	---
0.490 ~ 1.705	30	24000/F(kHz)	---
1.705 ~ 30	30	30	---
30 ~ 88	3	100	40.0
88 ~ 216	3	150	43.5
216 ~ 960	3	200	46.0
960 ~ 1000	3	500	54.0
Above 1000	3	Other:74.0 dB(μ V)/m (Peak) 54.0 dB(μ V)/m (Average)	

Remark: (1) Emission level dB μ V = 20 log Emission level μ V/m
 (2) The smaller limit shall apply at the cross point between two frequency bands.
 (3) Distance is the distance in meters between the measuring instrument, antenna and the closest point of any part of the device or system.

8.2 MEASUREMENT PROCEDURE

- The measuring distance of 3m shall be used for measurements. The EUT was placed on the top of a rotating table 0.8 meter above the ground at a 3 meter semi-anechoic chamber. The table was rotated 360 degrees to determine the position of the highest radiation(Below 1GHz)
- The measuring distance of 3m shall used for measurements. The EUT was placed on the top of a rotating table 1.5 meter above the ground at a 3 meter semi-anechoic chamber. The table was rotated 360 degrees to determine the position of the highest radiation(Above 1GHz)
- The height of the test antenna shall vary between 1m to 4m.Both horizontal and vertical polarization Of the antenna are set to make the measurement.
- The initial step in collecting radiated emission data is a receive peak detector mode. Pre-scanning the measurement frequency range. Significant peaks are then marked and then Quasi Peak detector mode re-measured.
- All readings are peak unless otherwise stated QP in column of Note. Peak denoted that the Peak reading compliance with the QP limits and then QP Mode measurement didn't perform(Below 1GHz)
- All readings are Peak mode value unless otherwise stated AVG in column of Note. If the Peak mode measured value compliance with the Peak limits and lower than AVG Limits, the EUT shall be deemed to meet Peak&AVG limits and then only Peak mode was measured, but AVG mode didn't perform.(Above 1GHz).

The results shown in this test report refer only to the sample(s) tested unless otherwise stated and the sample(s) are retained for 30 days only. The document is issued by AGC, this document cannot be reproduced except in full with our prior written permission. The more details and the authenticity of the report will be confirmed at <http://www.agc-cert.com>.

8.3 TEST SETUP

RADIATED EMISSION TEST SETUP BELOW 30MHz

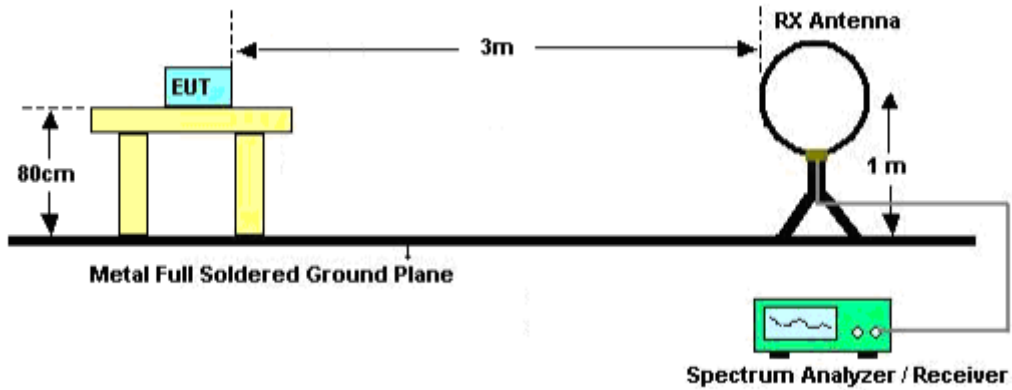

RADIATED EMISSION TEST SETUP 30MHz-1000MHz

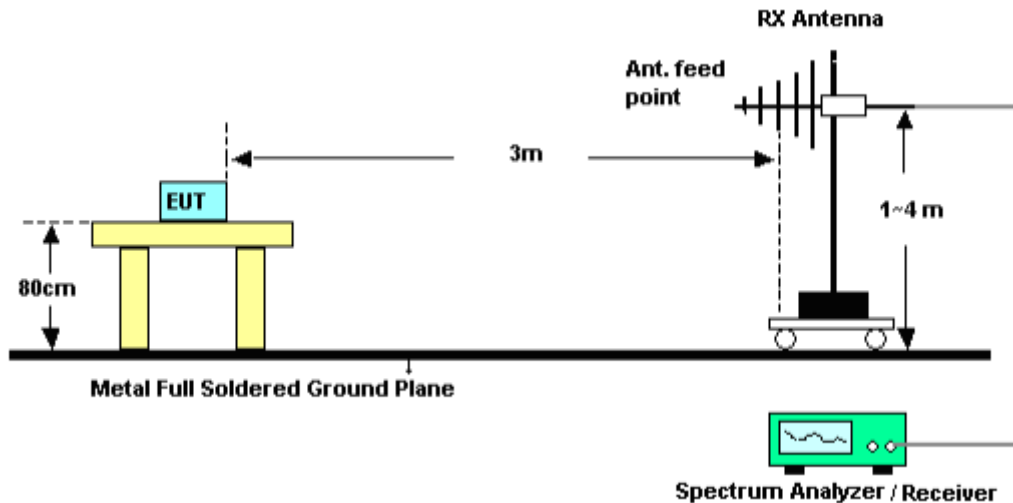

The results shown in this test report refer only to the sample(s) tested unless otherwise stated and the sample(s) are retained for 30 days only. The document is issued by AGC, this document cannot be reproduced except in full with our prior written permission. The more details and the authenticity of the report will be confirmed at <http://www.agc-cert.com>.

RADIATED EMISSION TEST SETUP ABOVE 1000MHz

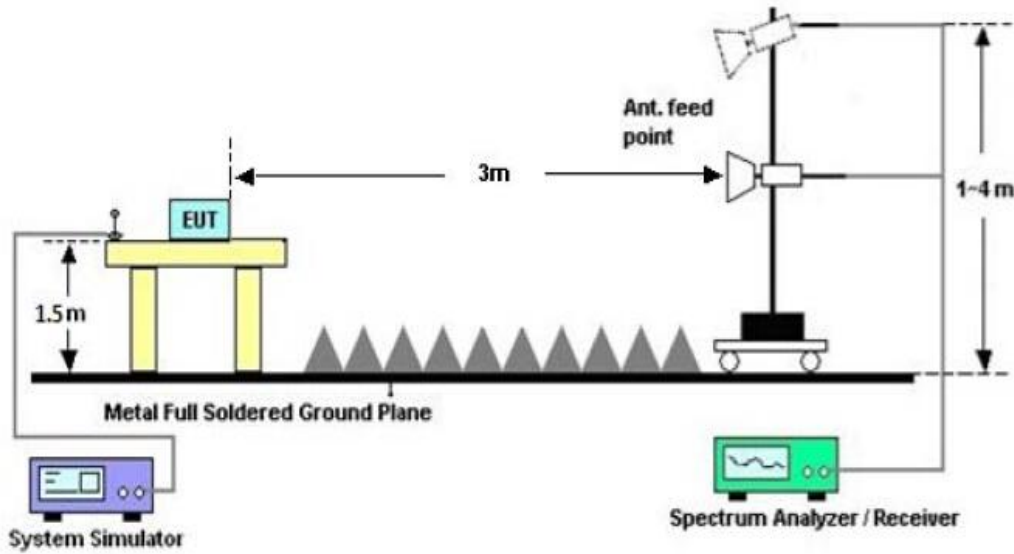

The results shown in this test report refer only to the sample(s) tested unless otherwise stated and the sample(s) are retained for 30 days only. The document is issued by AGC, this document cannot be reproduced except in full with our prior written permission. The more details and the authenticity of the report will be confirmed at <http://www.agc-cert.com>.

8.4 TEST RESULT

RADIATED EMISSION BELOW 30MHz

No emission found between lowest internal used/generated frequencies to 30MHz.

RADIATED EMISSION BELOW 1GHz

RADIATED EMISSION TEST- (30MHz-1GHz)-LOW CHANNEL-HORIZONTAL

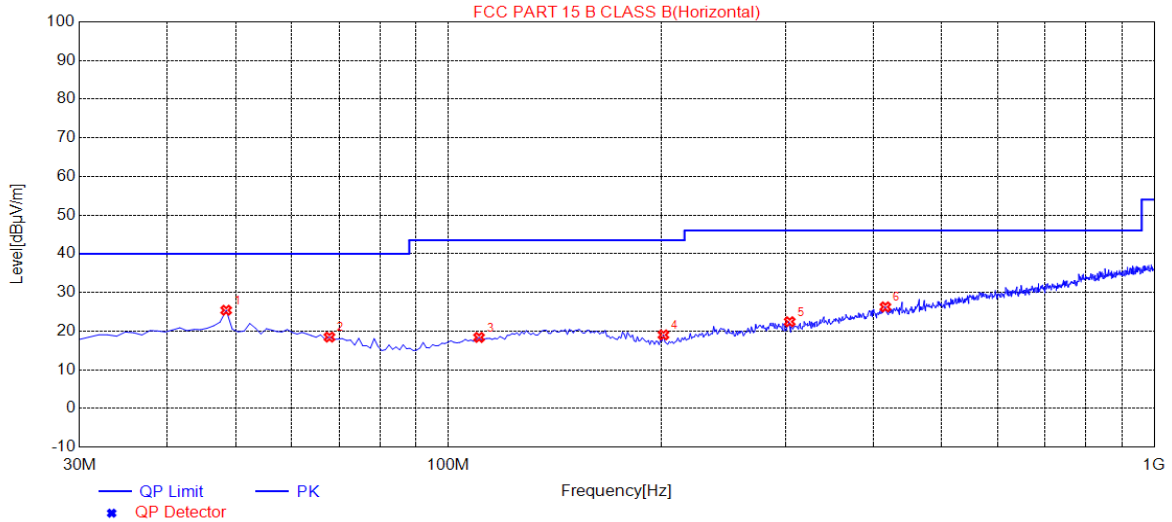

Suspected Data List								
NO.	Freq. [MHz]	Level [dBµV/m]	Factor [dB]	Limit [dBµV/m]	Margin [dB]	Height [cm]	Angle [°]	Polarity
1	48.4300	25.39	14.71	40.00	14.61	100	200	Horizontal
2	67.8300	18.44	12.59	40.00	21.56	150	270	Horizontal
3	110.510	18.36	12.47	43.50	25.14	100	240	Horizontal
4	201.690	19.01	12.17	43.50	24.49	200	310	Horizontal
5	304.510	22.42	16.07	46.00	23.58	200	320	Horizontal
6	416.060	26.25	20.14	46.00	19.75	150	220	Horizontal

RESULT: PASS

The results shown in this test report refer only to the sample(s) tested unless otherwise stated and the sample(s) are retained for 30 days only. The document is issued by AGC, this document cannot be reproduced except in full with our prior written permission. The more details and the authenticity of the report will be confirmed at <http://www.agc-cert.com>.

RADIATED EMISSION TEST- (30MHz-1GHz)-LOW CHANNEL -VERTICAL

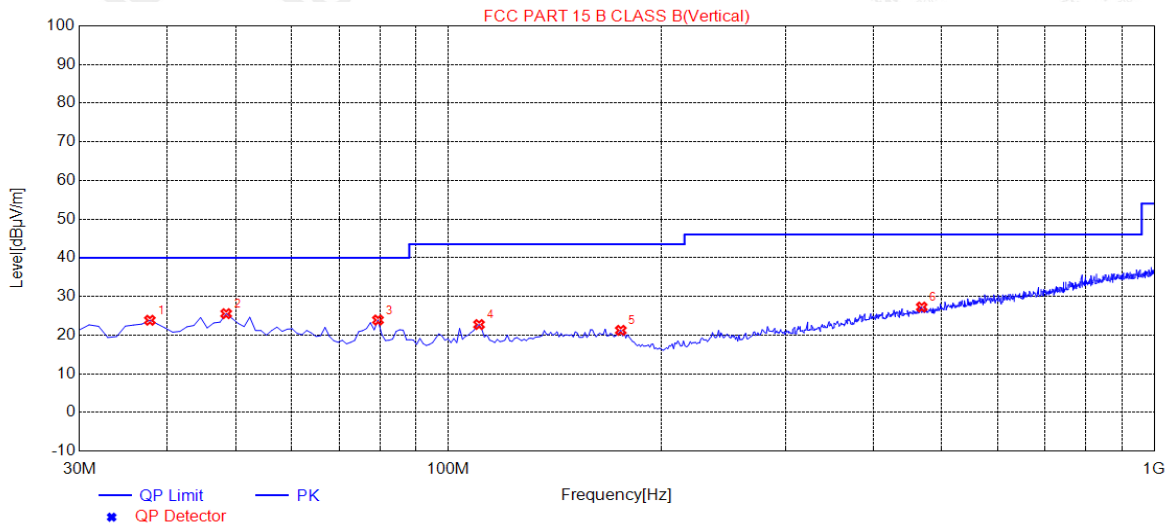

Suspected Data List								
NO.	Freq. [MHz]	Level [dBµV/m]	Factor [dB]	Limit [dBµV/m]	Margin [dB]	Height [cm]	Angle [°]	Polarity
1	37.7600	23.83	14.39	40.00	16.17	100	170	Vertical
2	48.4300	25.54	14.71	40.00	14.46	200	290	Vertical
3	79.4700	23.89	10.26	40.00	16.11	200	120	Vertical
4	110.510	22.72	12.47	43.50	20.78	200	10	Vertical
5	175.500	21.22	13.43	43.50	22.28	200	320	Vertical
6	468.440	27.25	21.38	46.00	18.75	200	30	Vertical

RESULT: PASS

Note: 1. Factor=Antenna Factor + Cable loss, Margin=Measurement-Limit.

2. The "Factor" value can be calculated automatically by software of measurement system.

3. All modes were tested, and only the data of worst case mode 1 was recorded in this report.

The results shown in this test report refer only to the sample(s) tested unless otherwise stated and the sample(s) are retained for 30 days only. The document is issued by AGC, this document cannot be reproduced except in full with our prior written permission. The more details and the authenticity of the report will be confirmed at <http://www.agc-cert.com>.

RADIATED EMISSION ABOVE 1GHZ FOR BLE

EUT:	Soundcore Life 2 NC	Model Name. :	A3024
Temperature:	20 °C	Relative Humidity:	48%
Pressure:	1010 hPa	Test Voltage :	DC 3.7V
Test Mode :	Mode 1	Polarization :	Horizontal

Frequency	Meter Reading	Factor	Emission Level	Limits	Margin	Value Type
(MHz)	(dBμV)	(dB)	(dBμV/m)	(dBμV/m)	(dB)	
4804.026	48.23	3.76	51.99	74	-22.01	peak
4804.026	46.75	3.76	50.51	54	-3.49	AVG
7206.039	37.79	8.17	45.96	74	-28.04	peak
7206.039	33.78	8.17	41.95	54	-12.05	AVG

Remark:

Factor = Antenna Factor + Cable Loss – Pre-amplifier.

EUT:	Soundcore Life 2 NC	Model Name. :	A3024
Temperature:	20 °C	Relative Humidity:	48%
Pressure:	1010 hPa	Test Voltage :	DC 3.7V
Test Mode :	Mode 1	Polarization :	Vertical

Frequency	Meter Reading	Factor	Emission Level	Limits	Margin	Value Type
(MHz)	(dBμV)	(dB)	(dBμV/m)	(dBμV/m)	(dB)	
4804.026	51.09	3.76	54.85	74	-19.15	peak
4804.026	45.23	3.76	48.99	54	-5.01	AVG
7206.039	40.35	8.17	48.52	74	-25.48	peak
7206.039	37.78	8.17	45.95	54	-8.05	AVG

Remark:

Factor = Antenna Factor + Cable Loss – Pre-amplifier.

The results shown in this test report refer only to the sample(s) tested unless otherwise stated and the sample(s) are retained for 30 days only. The document is issued by AGC, this document cannot be reproduced except in full with our prior written permission. The more details and the authenticity of the report will be confirmed at <http://www.agc-cert.com>.

EUT:	Soundcore Life 2 NC	Model Name. :	A3024
Temperature:	20 °C	Relative Humidity:	48%
Pressure:	1010 hPa	Test Voltage :	DC 3.7V
Test Mode :	Mode 2	Polarization :	Horizontal

Frequency	Meter Reading	Factor	Emission Level	Limits	Margin	Value Type
(MHz)	(dB μ V)	(dB)	(dB μ V/m)	(dB μ V/m)	(dB)	
4880.032	48.84	3.78	52.62	74	-21.38	peak
4880.032	44.64	3.78	48.42	54	-5.58	AVG
7323.048	42.76	8.23	50.99	74	-23.01	peak
7323.048	41.29	8.23	49.52	54	-4.48	AVG
Remark:						
Factor = Antenna Factor + Cable Loss – Pre-amplifier.						

EUT:	Soundcore Life 2 NC	Model Name. :	A3024
Temperature:	20 °C	Relative Humidity:	48%
Pressure:	1010 hPa	Test Voltage :	DC 3.7V
Test Mode :	Mode 2	Polarization :	Vertical

Frequency	Meter Reading	Factor	Emission Level	Limits	Margin	Value Type
(MHz)	(dB μ V)	(dB)	(dB μ V/m)	(dB μ V/m)	(dB)	
4880.032	50.19	3.78	53.97	74	-20.03	peak
4880.032	45.77	3.78	49.55	54	-4.45	AVG
7323.048	41.75	8.23	49.98	74	-24.02	peak
7323.048	39.07	8.23	47.3	54	-6.7	AVG
Remark:						
Factor = Antenna Factor + Cable Loss – Pre-amplifier.						

The results shown in this test report refer only to the sample(s) tested unless otherwise stated and the sample(s) are retained for 30 days only. The document is issued by AGC, this document cannot be reproduced except in full with our prior written permission. The more details and the authenticity of the report will be confirmed at <http://www.agc-cert.com>.

EUT:	Soundcore Life 2 NC	Model Name. :	A3024
Temperature:	20 °C	Relative Humidity:	48%
Pressure:	1010 hPa	Test Voltage :	DC 3.7V
Test Mode :	Mode 3	Polarization :	Horizontal

Frequency	Meter Reading	Factor	Emission Level	Limits	Margin	Value Type
(MHz)	(dBμV)	(dB)	(dBμV/m)	(dBμV/m)	(dB)	
4960.042	47.98	3.81	51.79	74	-22.21	peak
4960.042	45.49	3.81	49.3	54	-4.7	AVG
7440.063	41.1	8.27	49.37	74	-24.63	peak
7440.063	38.34	8.27	46.61	54	-7.39	AVG
Remark:						
Factor = Antenna Factor + Cable Loss – Pre-amplifier.						

EUT:	Soundcore Life 2 NC	Model Name. :	A3024
Temperature:	20 °C	Relative Humidity:	48%
Pressure:	1010 hPa	Test Voltage :	DC 3.7V
Test Mode :	Mode 3	Polarization :	Vertical

Frequency	Meter Reading	Factor	Emission Level	Limits	Margin	Value Type
(MHz)	(dBμV)	(dB)	(dBμV/m)	(dBμV/m)	(dB)	
4960.042	48.16	3.81	51.97	74	-22.03	peak
4960.042	46.47	3.81	50.28	54	-3.72	AVG
7440.063	42.32	8.27	50.59	74	-23.41	peak
7440.063	39.18	8.27	47.45	54	-6.55	AVG
Remark:						
Factor = Antenna Factor + Cable Loss – Pre-amplifier.						

Note: Other emissions from 8G to 25 GHz are considered as ambient noise. No recording in the test report.

Factor=Antenna Factor + Cable loss - Amplifier gain, Margin=Measurement-Limit.

The "Factor" value can be calculated automatically by software of measurement system.

Only the data of worst recorded in this report.

The results shown in this test report refer only to the sample(s) tested unless otherwise stated and the sample(s) are retained for 30 days only. The document is issued by AGC, this document cannot be reproduced except in full with our prior written permission. The more details and the authenticity of the report will be confirmed at <http://www.agc-cert.com>.

9. BAND EDGE EMISSION

9.1. MEASUREMENT PROCEDURE

1. Set the EUT Work on the top, the bottom operation frequency individually.
2. Set SPA Start or Stop Frequency=Operation Frequency,
For unrestricted band: RBW=100kHz, VBW=300kHz
For restricted band: RBW=1MHz, VBW=3*RBW
Center frequency =Operation frequency
3. The band edges was measured and recorded.

9.2. TEST SET-UP

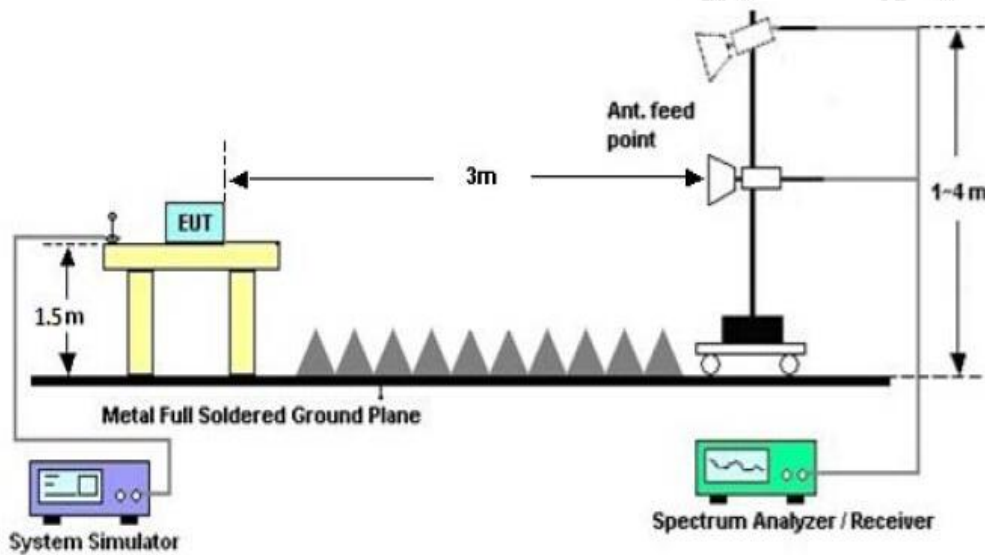

The results shown in this test report refer only to the sample(s) tested unless otherwise stated and the sample(s) are retained for 30 days only. The document is issued by AGC, this document cannot be reproduced except in full with our prior written permission. The more details and the authenticity of the report will be confirmed at <http://www.agc-cert.com>.

9.3. TEST RESULT

FOR BLE:

EUT:	Soundcore Life 2 NC	Model Name. :	A3024
Temperature:	20 °C	Relative Humidity:	48%
Pressure:	1010 hPa	Test Voltage :	DC 3.7V
Test Mode :	Mode 1	Polarization :	Horizontal

PK Value

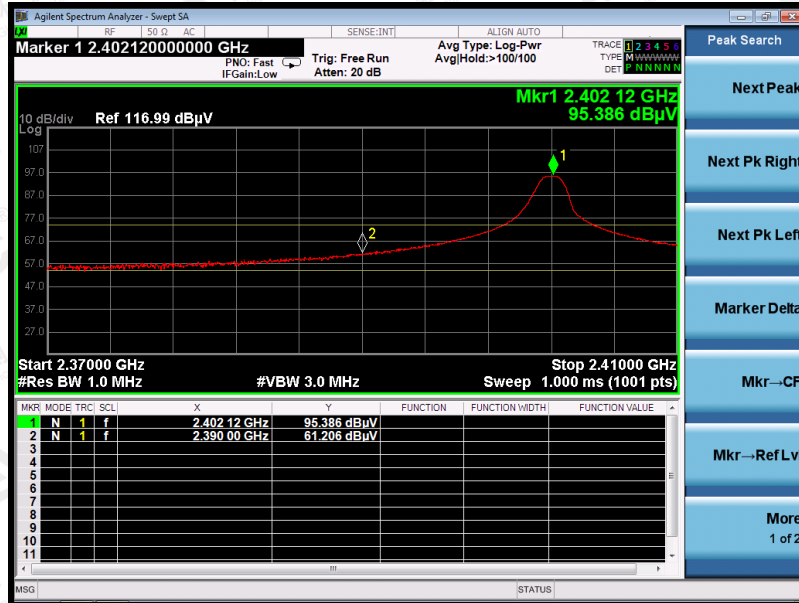

AV Value



The results shown in this test report refer only to the sample(s) tested unless otherwise stated and the sample(s) are retained for 30 days only. The document is issued by AGC, this document cannot be reproduced except in full with our prior written permission. The more details and the authenticity of the report will be confirmed at <http://www.agc-cert.com>.

EUT:	Soundcore Life 2 NC	Model Name. :	A3024
Temperature:	20 °C	Relative Humidity:	48%
Pressure:	1010 hPa	Test Voltage :	DC 3.7V
Test Mode :	Mode 1	Polarization :	Vertical

PK Value

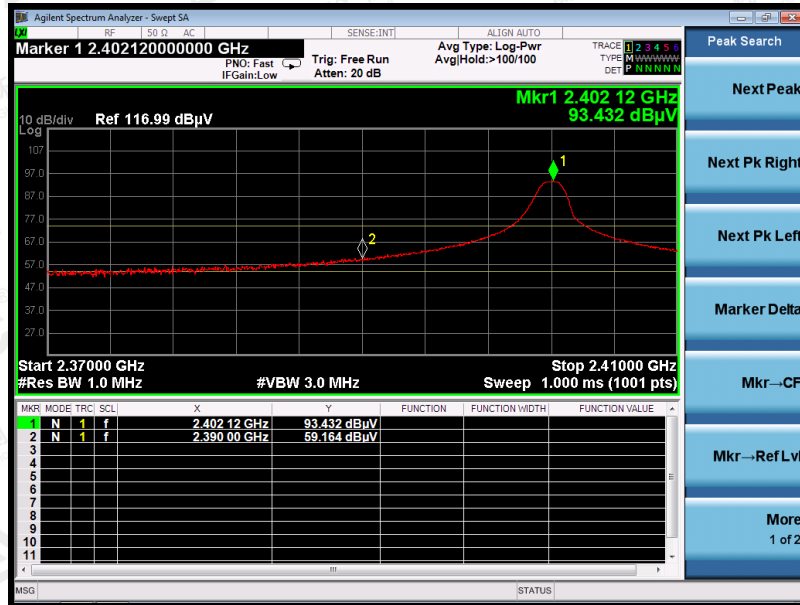

AV Value



The results shown in this test report refer only to the sample(s) tested unless otherwise stated and the sample(s) are retained for 30 days only. The document is issued by AGC, this document cannot be reproduced except in full with our prior written permission. The more details and the authenticity of the report will be confirmed at <http://www.agc-cert.com>.

EUT:	Soundcore Life 2 NC	Model Name. :	A3024
Temperature:	20 °C	Relative Humidity:	48%
Pressure:	1010 hPa	Test Voltage :	DC 3.7V
Test Mode :	Mode 3	Polarization :	Horizontal

PK Value



AV Value

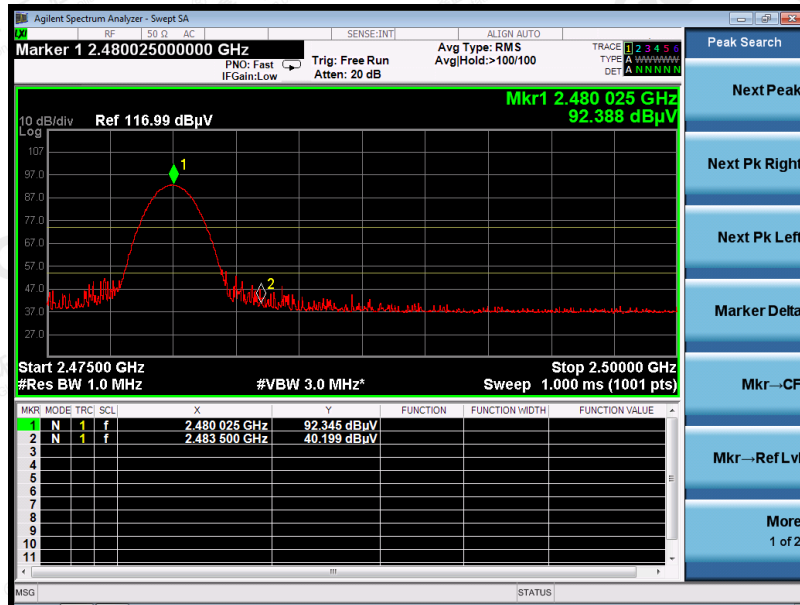

The results shown in this test report refer only to the sample(s) tested unless otherwise stated and the sample(s) are retained for 30 days only. The document is issued by AGC, this document cannot be reproduced except in full with our prior written permission. The more details and the authenticity of the report will be confirmed at <http://www.agc-cert.com>.

EUT:	Soundcore Life 2 NC	Model Name. :	A3024
Temperature:	20 °C	Relative Humidity:	48%
Pressure:	1010 hPa	Test Voltage :	DC 3.7V
Test Mode :	Mode 3	Polarization :	Vertical

PK Value



AV Value

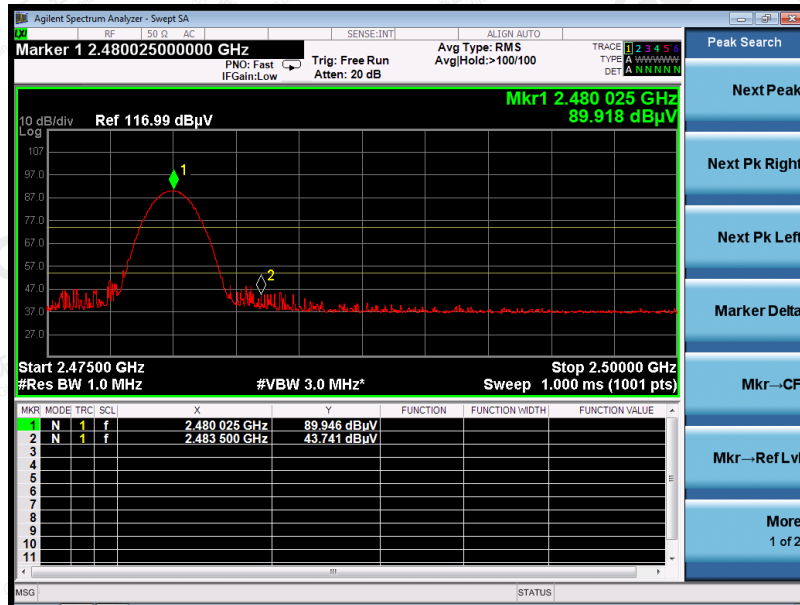

Note: The factor had been edited in the "Input Correction" of the Spectrum Analyzer. So the Amplitude of test plots is equal to Reading level plus the Factor in dB. Use the A dB(μV) to represent the Amplitude. Use the F dB(μV/m) to represent the Field Strength. So A=F.

The results shown in this test report refer only to the sample(s) tested unless otherwise stated and the sample(s) are retained for 30 days only. The document is issued by AGC, this document cannot be reproduced except in full with our prior written permission. The more details and the authenticity of the report will be confirmed at <http://www.agc-cert.com>.

10. 6DB BANDWIDTH

10.1. TEST PROCEDURE

1. Connect EUT RF output port to the Spectrum Analyzer through an RF attenuator
2. Set the EUT Work on the top, the middle and the bottom operation frequency individually.
3. Set SPA Centre Frequency = Operation Frequency, RBW= 100 KHz, VBW ≥ 3*RBW.
4. Set SPA Trace 1 Max hold, then View.

10.2. SUMMARY OF TEST RESULTS/PLOTS

Channel	6dB Bandwidth (KHz)	Minimum Limit (KHz)	Pass/Fail
Low	700	500KHz	Pass
Middle	705		Pass
High	704		Pass

TEST PLOT OF BANDWIDTH FOR LOW CHANNEL

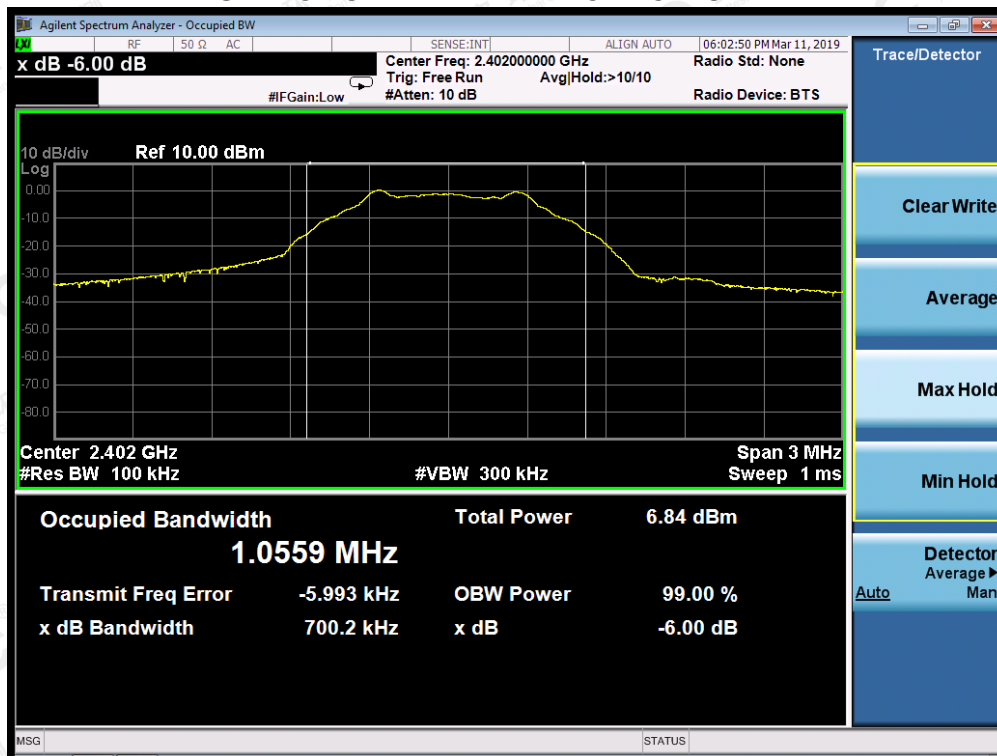

The results shown in this test report refer only to the sample(s) tested unless otherwise stated and the sample(s) are retained for 30 days only. The document is issued by AGC, this document cannot be reproduced except in full with our prior written permission. The more details and the authenticity of the report will be confirmed at <http://www.agc-cert.com>.

TEST PLOT OF BANDWIDTH FOR MIDDLE CHANNEL



TEST PLOT OF BANDWIDTH FOR HIGH CHANNEL

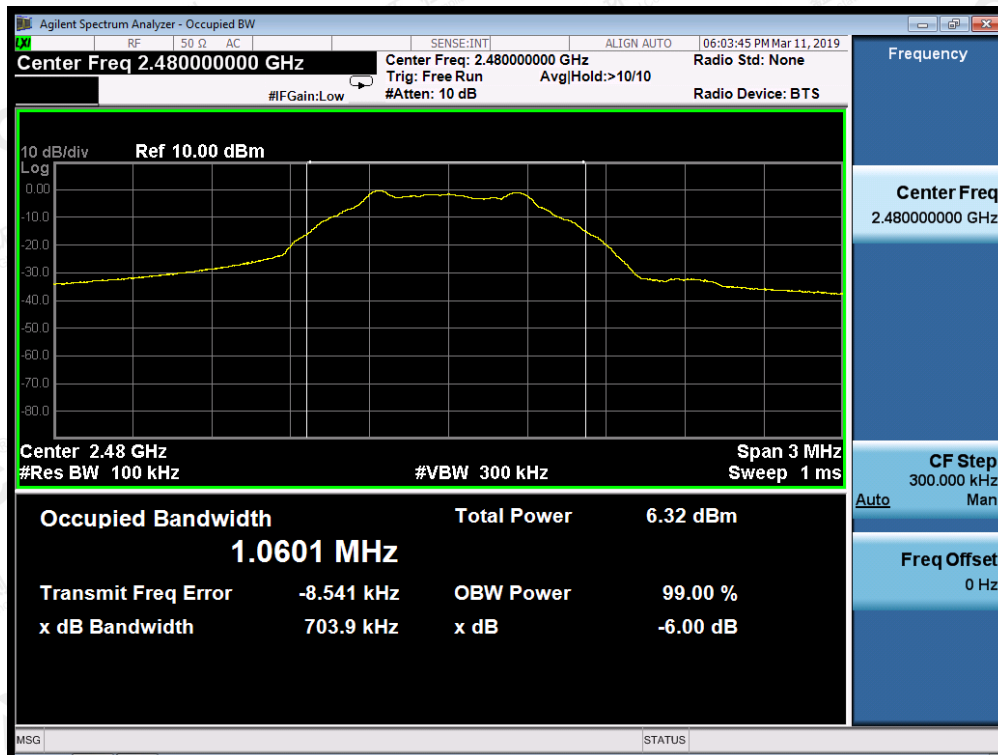

The results shown in this test report refer only to the sample(s) tested unless otherwise stated and the sample(s) are retained for 30 days only. The document is issued by AGC, this document cannot be reproduced except in full with our prior written permission. The more details and the authenticity of the report will be confirmed at <http://www.agc-cert.com>.

11. CONDUCTED OUTPUT POWER

11.1. MEASUREMENT PROCEDURE

1. Connect EUT RF output port to the Spectrum Analyzer through an RF attenuator
2. Set the EUT Work on the top, middle and the bottom operation frequency individually.
3. Use the following spectrum analyzer settings:
 - a) Set the RBW \geq DTS bandwidth.
 - b) Set VBW \geq 3 RBW.
 - c) Set span \geq 3 x RBW
 - d) Sweep time = auto couple.
 - e) Detector = peak.
 - f) Trace mode = max hold.
 - g) Allow trace to fully stabilize.
 - h) Use peak marker function to determine the peak amplitude level.
4. Allow the trace to stabilize.
5. Record the result form the Spectrum Analyzer.

11.2. TEST SET-UP (BLOCK DIAGRAM OF CONFIGURATION)

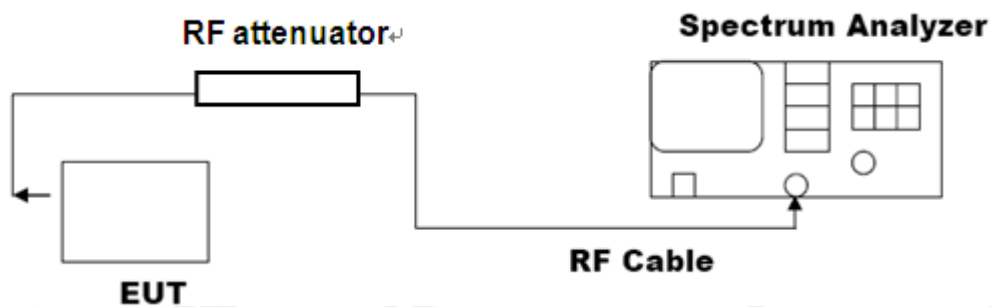

The results shown in this test report refer only to the sample(s) tested unless otherwise stated and the sample(s) are retained for 30 days only. The document is issued by AGC, this document cannot be reproduced except in full with our prior written permission. The more details and the authenticity of the report will be confirmed at <http://www.agc-cert.com>.

11.3. LIMITS AND MEASUREMENT RESULT

Channel	Peak Power (dBm)	Applicable Limits (dBm)	Pass/Fail
Low Channel	0.938	30	Pass
Middle Channel	0.973	30	Pass
High Channel	0.326	30	Pass

The Low Channel Result



The results shown in this test report refer only to the sample(s) tested unless otherwise stated and the sample(s) are retained for 30 days only. The document is issued by AGC, this document cannot be reproduced except in full with our prior written permission. The more details and the authenticity of the report will be confirmed at <http://www.agc-cert.com>.

The Middle Channel Result



The High Channel Result



The results shown in this test report refer only to the sample(s) tested unless otherwise stated and the sample(s) are retained for 30 days only. The document is issued by AGC, this document cannot be reproduced except in full with our prior written permission. The more details and the authenticity of the report will be confirmed at <http://www.agc-cert.com>.

12. CONDUCTED SPURIOUS EMISSION

12.1. MEASUREMENT PROCEDURE

1. Connect EUT RF output port to the Spectrum Analyzer through an RF attenuator
2. Set the EUT Work on the top, the Middle and the bottom operation frequency individually.
3. Set the Span = wide enough to capture the peak level of the in-band emission and all spurious emissions from the lowest frequency generated in the EUT up through the 10th harmonic.
RBW = 100kHz; VBW ≥3 RBW; Sweep = auto; Detector function = peak.
4. Set SPA Trace 1 Max hold, then View.

12.2. TEST SET-UP (BLOCK DIAGRAM OF CONFIGURATION)

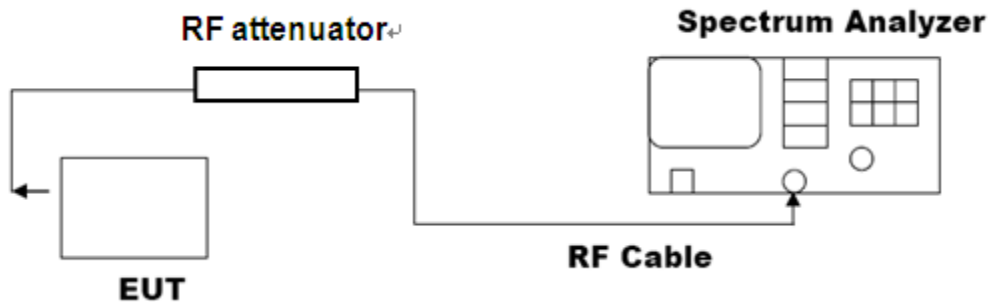

12.3. LIMITS AND MEASUREMENT RESULT

LIMITS AND MEASUREMENT RESULT		
Applicable Limits	Measurement Result	
	Test Data	Result
In any 100 KHz Bandwidth Outside the frequency band in which the spread spectrum intentional radiator is operating, the radio frequency power that is produce by the intentional radiator shall be at least 20 dB below that in 100KHz bandwidth within the band that contains the highest level of the desired power. In addition, radiation emissions which fall in the restricted bands, as defined in §15.205(a), must also comply with the radiated emission limits specified in§15.209(a)	At least -20dBc than the limit Specified on the BOTTOM Channel	PASS
	At least -20dBc than the limit Specified on the TOP Channel	PASS

The results shown in this test report refer only to the sample(s) tested unless otherwise stated and the sample(s) are retained for 30 days only. The document is issued by AGC, this document cannot be reproduced except in full with our prior written permission. The more details and the authenticity of the report will be confirmed at <http://www.agc-cert.com>.

TEST PLOT OF OUT OF BAND EMISSIONS
OF GFSK MODULATION IN LOW CHANNEL

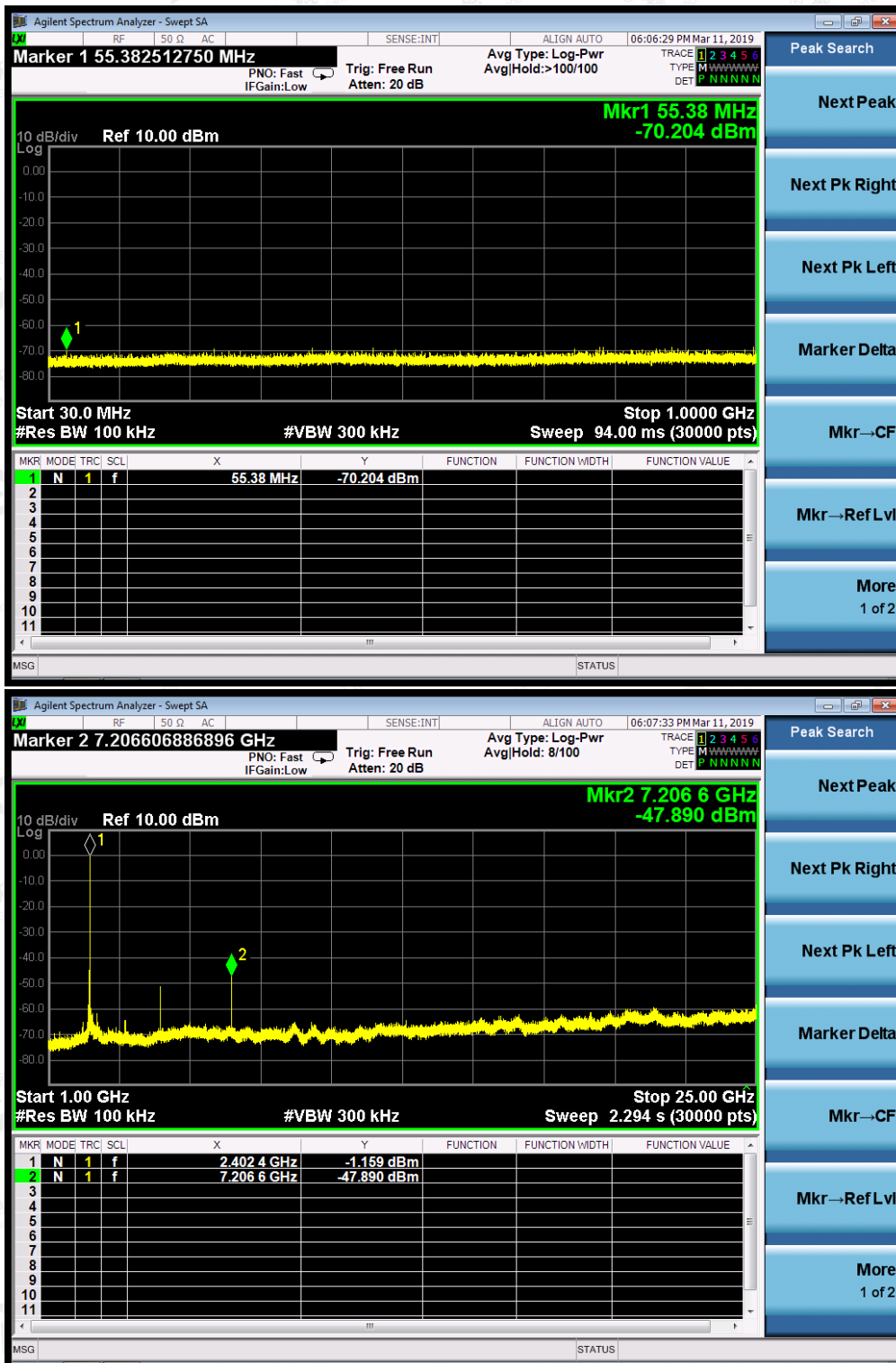

The results shown in this test report refer only to the sample(s) tested unless otherwise stated and the sample(s) are retained for 30 days only. The document is issued by AGC, this document cannot be reproduced except in full with our prior written permission. The more details and the authenticity of the report will be confirmed at <http://www.agc-cert.com>.

TEST PLOT OF OUT OF BAND EMISSIONS
OF GFSK MODULATION IN MIDDLE CHANNEL

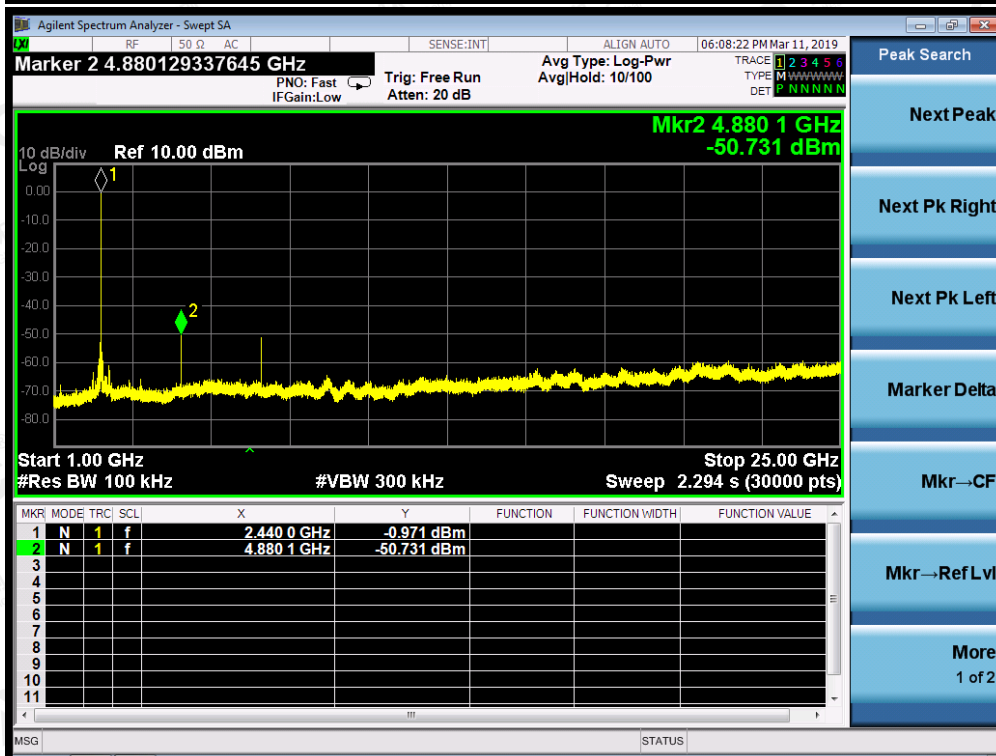
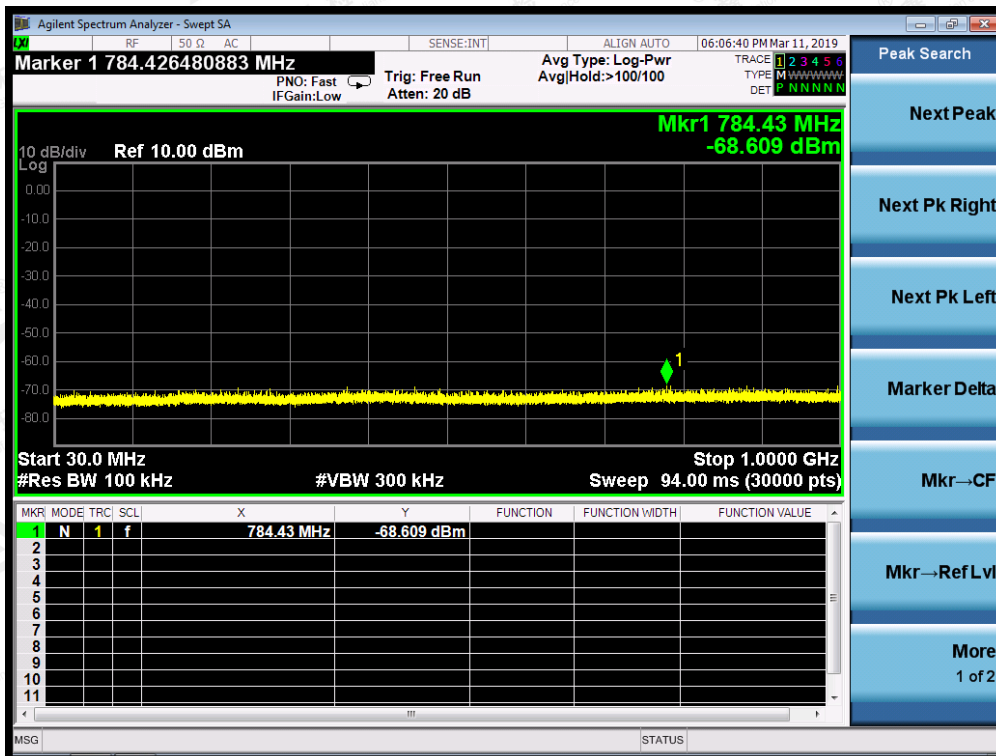

The results shown in this test report refer only to the sample(s) tested unless otherwise stated and the sample(s) are retained for 30 days only. The document is issued by AGC, this document cannot be reproduced except in full with our prior written permission. The more details and the authenticity of the report will be confirmed at <http://www.agc-cert.com>.

TEST PLOT OF OUT OF BAND EMISSIONS
OF GFSK MODULATION IN HIGH CHANNEL

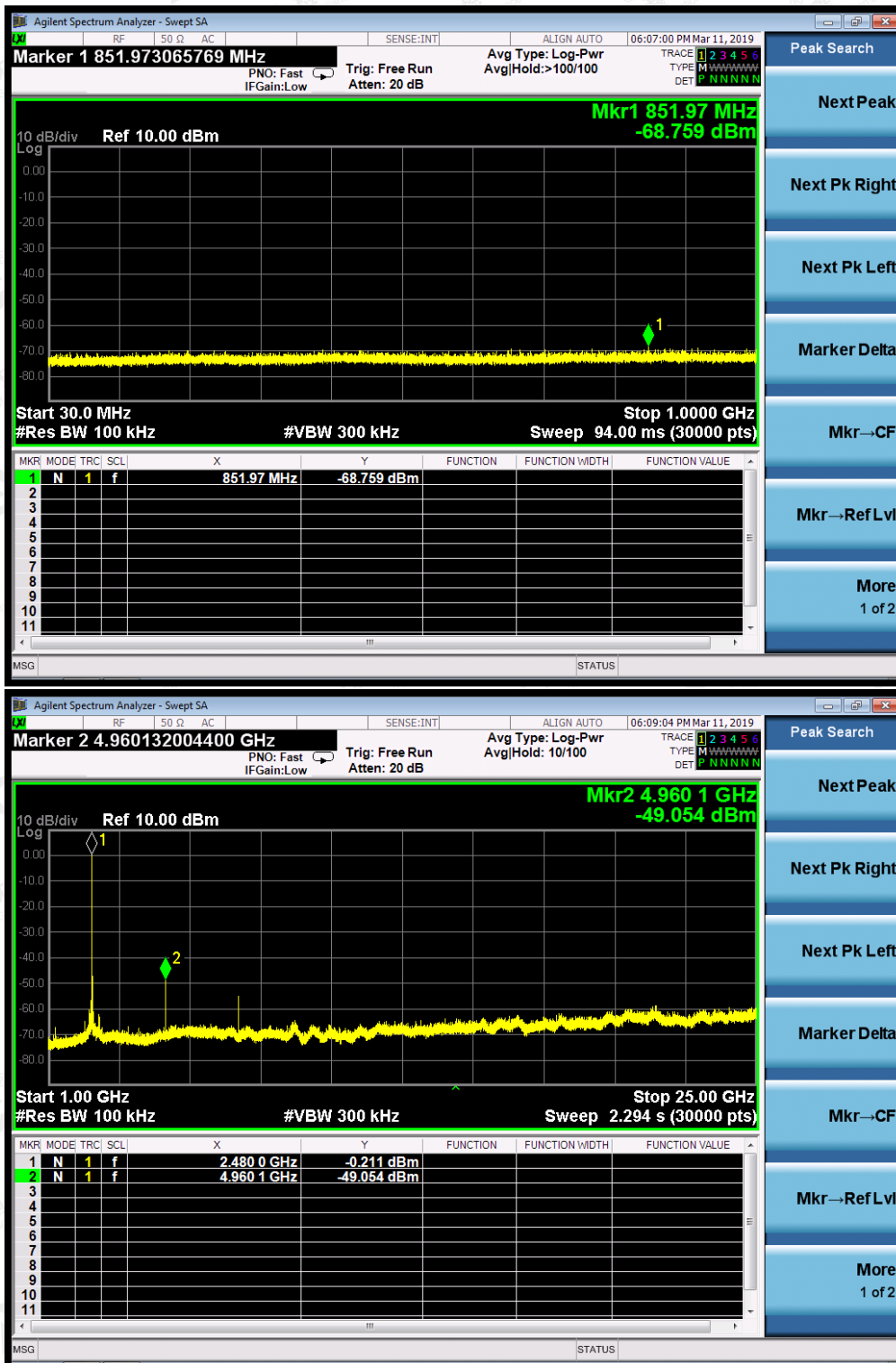

The results shown in this test report refer only to the sample(s) tested unless otherwise stated and the sample(s) are retained for 30 days only. The document is issued by AGC, this document cannot be reproduced except in full with our prior written permission. The more details and the authenticity of the report will be confirmed at <http://www.agc-cert.com>.

**TEST RESULT FOR BAND EDGE
LOW CHANNEL**

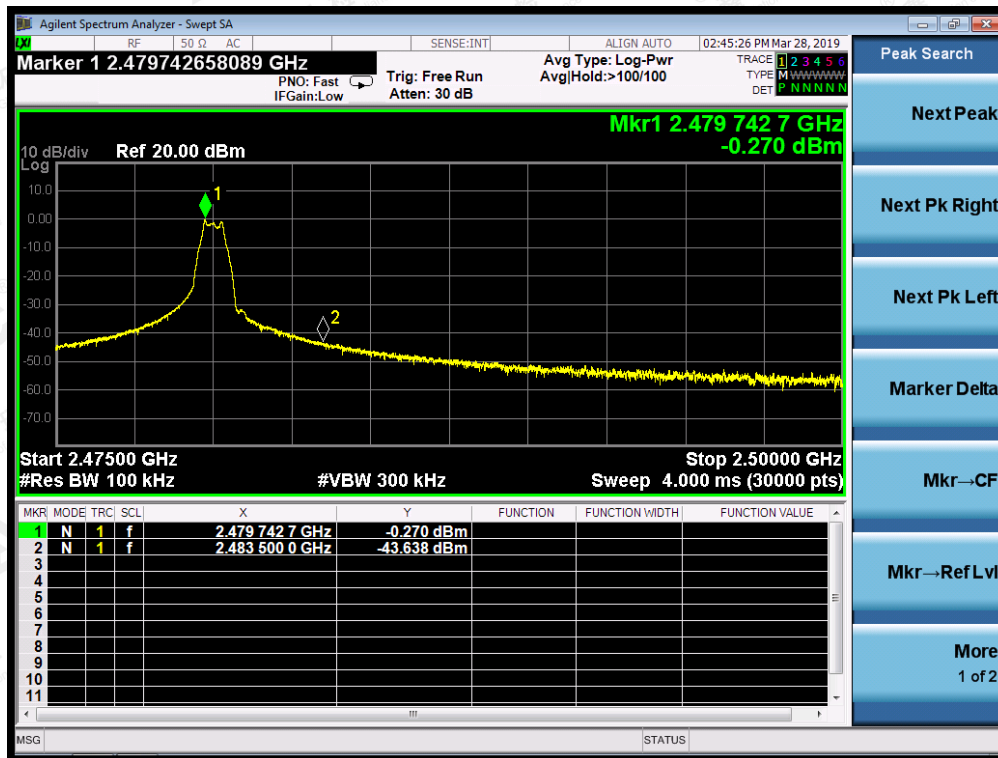

HIGH CHANNEL

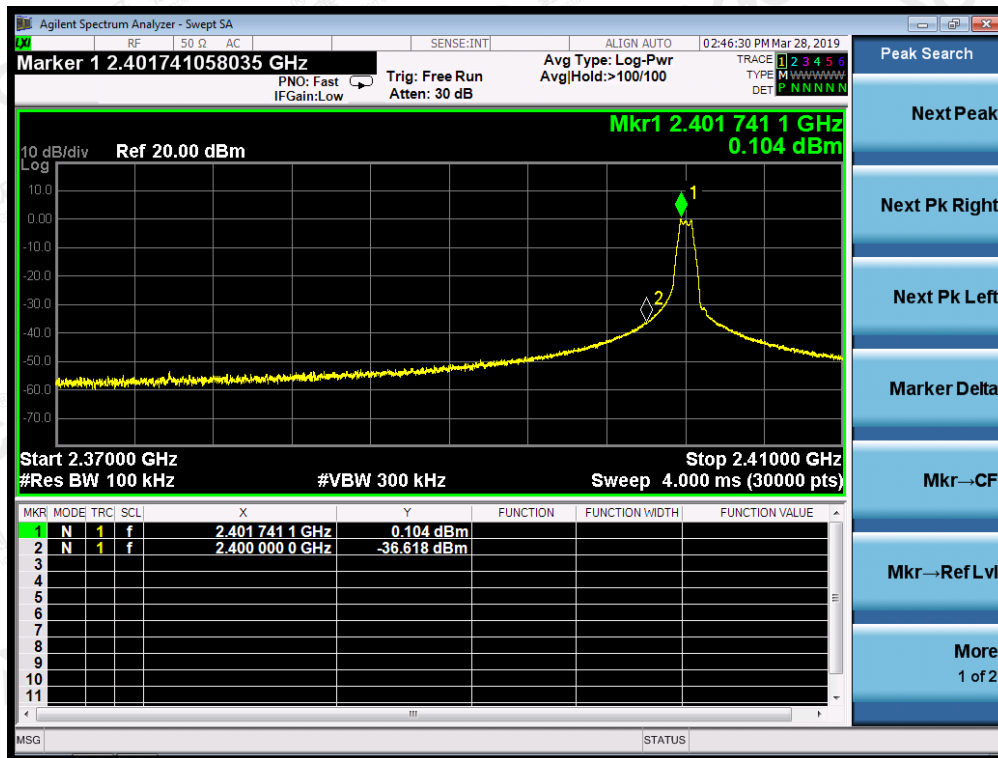

The results shown in this test report refer only to the sample(s) tested unless otherwise stated and the sample(s) are retained for 30 days only. The document is issued by AGC, this document cannot be reproduced except in full with our prior written permission. The more details and the authenticity of the report will be confirmed at <http://www.agc-cert.com>.

13. CONDUCTED OUTPUT POWER SPECTRAL DENSITY

13.1 MEASUREMENT PROCEDURE

- (1). Connect EUT RF output port to the Spectrum Analyzer through an RF attenuator
- (2). Set the EUT Work on the top, the middle and the bottom operation frequency individually.
- (3). Set the span to 1.5times the DTS bandwidth, RBW: $3\text{kHz} \leq \text{RBW} \leq 100\text{kHz}$, $\text{VBW} \geq 3 \times \text{RBW}$
- (4). Set SPA Trace 1 Max hold, then View.

Note: The EUT was tested according to KDB 558074 for compliance to FCC 47CFR 15.247 requirements.

13.2 TEST SET-UP (BLOCK DIAGRAM OF CONFIGURATION)

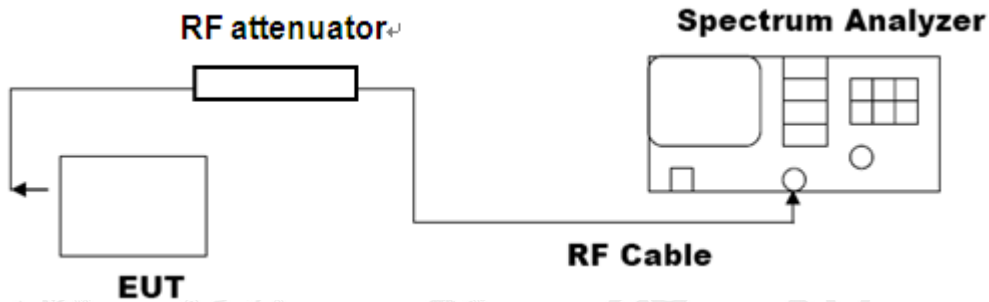

13.3 LIMITS AND MEASUREMENT RESULT

Channel No.	PSD (dBm/3KHz)	Limit (dBm/3KHz)	Result
Low Channel	-14.674	8	Pass
Middle Channel	-14.555	8	Pass
High Channel	-15.166	8	Pass

The results shown in this test report refer only to the sample(s) tested unless otherwise stated and the sample(s) are retained for 30 days only. The document is issued by AGC, this document cannot be reproduced except in full with our prior written permission. The more details and the authenticity of the report will be confirmed at <http://www.agc-cert.com>.

TEST PLOT OF SPECTRAL DENSITY FOR LOW CHANNEL

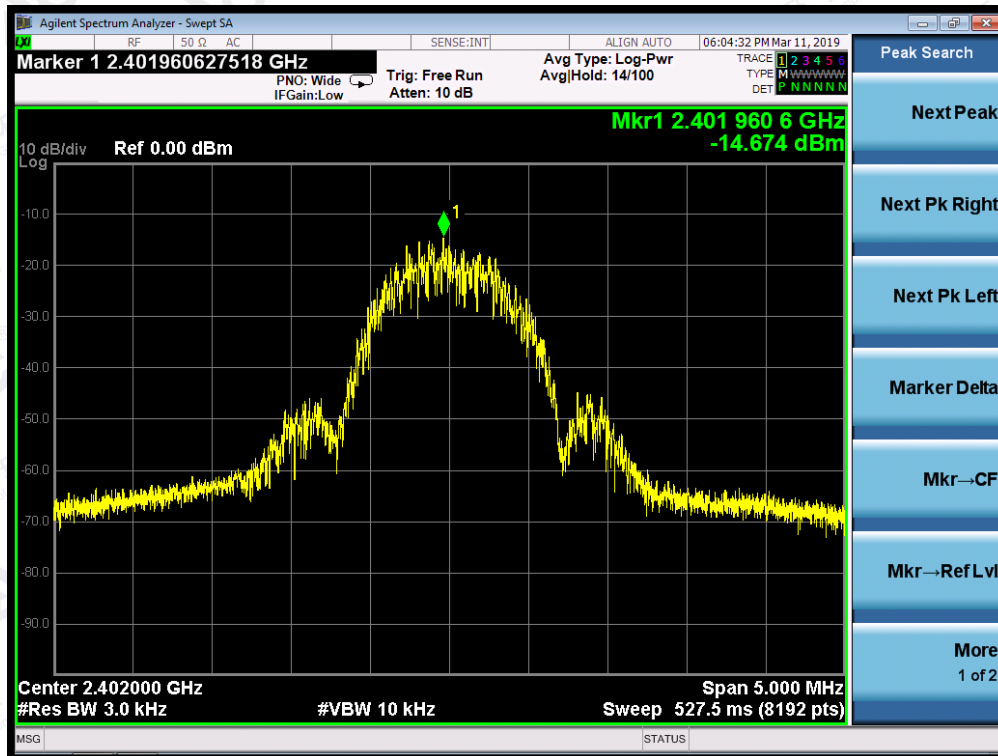

TEST PLOT OF SPECTRAL DENSITY FOR MIDDLE CHANNEL

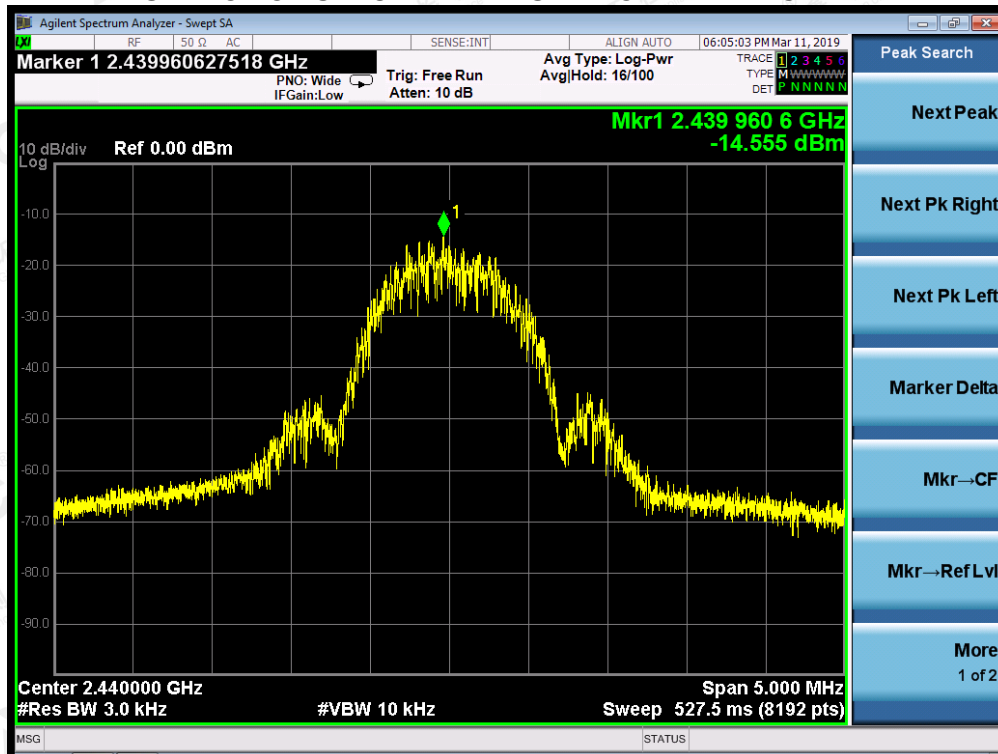

The results shown in this test report refer only to the sample(s) tested unless otherwise stated and the sample(s) are retained for 30 days only. The document is issued by AGC, this document cannot be reproduced except in full with our prior written permission. The more details and the authenticity of the report will be confirmed at <http://www.agc-cert.com>.

TEST PLOT OF SPECTRAL DENSITY FOR HIGH CHANNEL

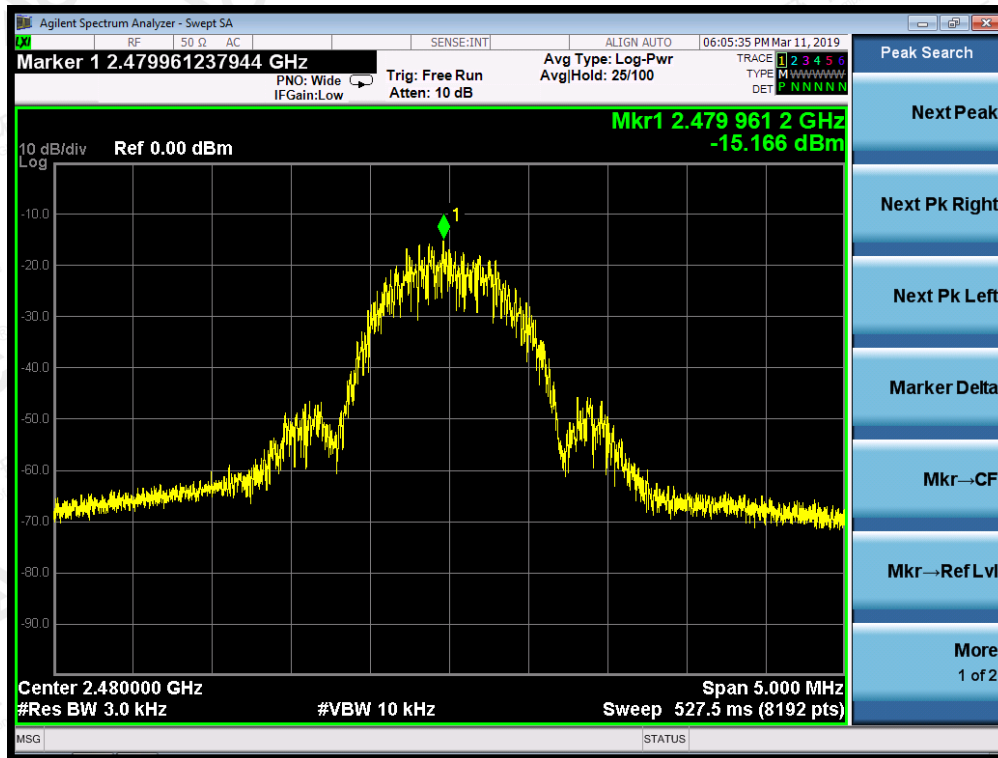

The results shown in this test report refer only to the sample(s) tested unless otherwise stated and the sample(s) are retained for 30 days only. The document is issued by AGC, this document cannot be reproduced except in full with our prior written permission. The more details and the authenticity of the report will be confirmed at <http://www.agc-cert.com>.

14. LINE CONDUCTED EMISSION TEST

14.1 LIMITS

Frequency	Maximum RF Line Voltage	
	Q.P.(dBuV)	Average(dBuV)
150kHz~500kHz	66-56	56-46
500kHz~5MHz	56	46
5MHz~30MHz	60	50

Note: 1. The lower limit shall apply at the transition frequency.

2. The limit decreases linearly with the logarithm of the frequency in the range 0.15 MHz to 0.50 MHz

14.2 TEST SETUP

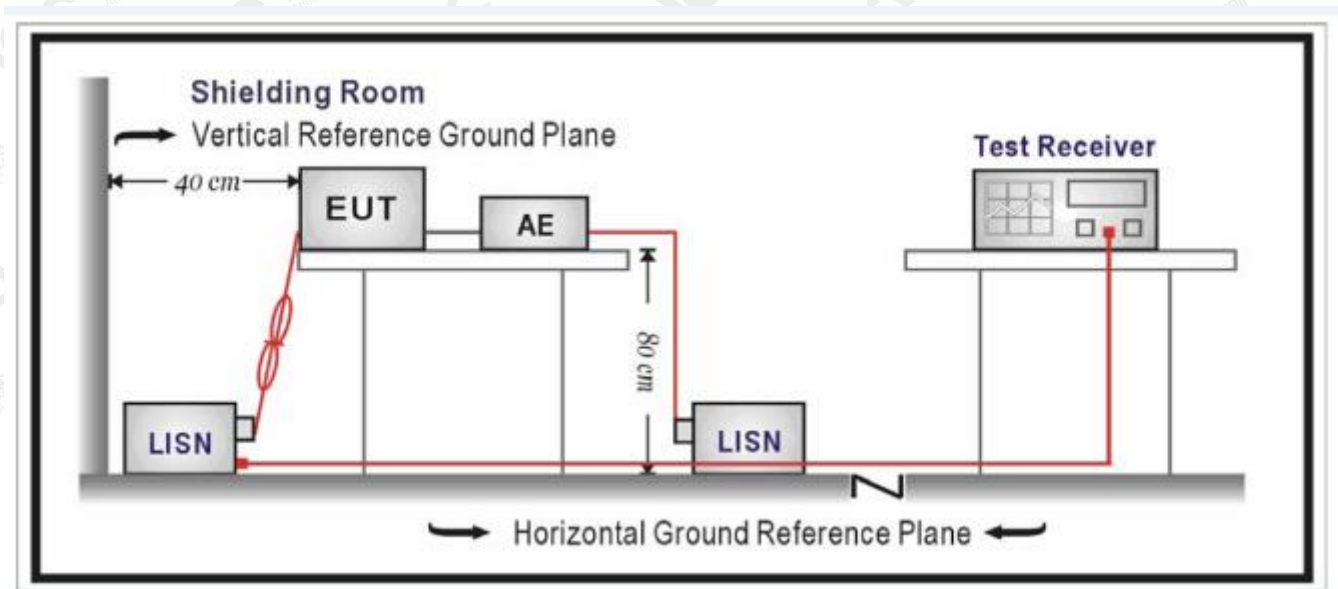

The results shown in this test report refer only to the sample(s) tested unless otherwise stated and the sample(s) are retained for 30 days only. The document is issued by AGC, this document cannot be reproduced except in full with our prior written permission. The more details and the authenticity of the report will be confirmed at <http://www.agc-cert.com>.

14.3 PRELIMINARY PROCEDURE

- 1) The equipment was set up as per the test configuration to simulate typical actual usage per the user's manual. When the EUT is a tabletop system, a wooden table with a height of 0.8 meters is used and is placed on the ground plane as per ANSI C63.10 (see Test Facility for the dimensions of the ground plane used). When the EUT is a floor-standing equipment, it is placed on the ground plane which has a 3-12 mm non-conductive covering to insulate the EUT from the ground plane.
- 2) Support equipment, if needed, was placed as per ANSI C63.10.
- 3) All I/O cables were positioned to simulate typical actual usage as per ANSI C63.10.
- 4) All support equipments received AC120V/60Hz power from a LISN, if any.
- 5) The EUT received DC charging voltage by adapter which received 120V/60Hz power by a LISN.
- 6) The test program was started. Emissions were measured on each current carrying line of the EUT using a spectrum Analyzer / Receiver connected to the LISN powering the EUT. The LISN has two monitoring points: Line 1 (Hot Side) and Line 2 (Neutral Side). Two scans were taken: one with Line 1 connected to Analyzer / Receiver and Line 2 connected to a 50 ohm load; the second scan had Line 1 connected to a 50 ohm load and Line 2 connected to the Analyzer / Receiver.
- 7) Analyzer / Receiver scanned from 150 kHz to 30MHz for emissions in each of the test modes.
- 8) During the above scans, the emissions were maximized by cable manipulation.
- 9) The following test mode(s) were scanned during the preliminary test.
Then, the EUT configuration and cable configuration of the above highest emission level were recorded for reference of final testing.

14.4 FINAL TEST PROCEDURE

- 1) EUT and support equipment was set up on the test bench as per step 2 of the preliminary test.
- 2) A scan was taken on both power lines, Line 1 and Line 2, recording at least the six highest emissions. Emission frequency and amplitude were recorded into a computer in which correction factors were used to calculate the emission level and compare reading to the applicable limit. If EUT emission level was less -2dB to the A.V. limit in Peak mode, then the emission signal was re-checked using Q.P and Average detector.
- 3) The test data of the worst case condition(s) was reported on the Summary Data page.

14.5 TEST RESULT OF POWER LINE

N/A

Note: The BT function of EUT didn't work when charging.

The results shown in this test report refer only to the sample(s) tested unless otherwise stated and the sample(s) are retained for 30 days only. The document is issued by AGC, this document cannot be reproduced except in full with our prior written permission. The more details and the authenticity of the report will be confirmed at <http://www.agc-cert.com>.

APPENDIX A: PHOTOGRAPHS OF TEST SETUP

Refer to Attached file(Appendix I).

APPENDIX B: PHOTOGRAPHS OF EUT

Refer to Attached file(Appendix I).

-----END OF REPORT-----

The results shown in this test report refer only to the sample(s) tested unless otherwise stated and the sample(s) are retained for 30 days only. The document is issued by AGC, this document cannot be reproduced except in full with our prior written permission. The more details and the authenticity of the report will be confirmed at <http://www.agc-cert.com>.