

FCC TEST REPORT

Client Name : Anker Innovations Limited
Address : Room 1318-19, Hollywood Plaza, 610 Nathan Road,
Mongkok, Kowloon, Hong Kong
Product Name : PowerWave Base Pad
Date : Sept. 03, 2019

Shenzhen Anbotek Compliance Laboratory Limited



Contents

1. General Information.....	4
1.1. Client Information.....	4
1.2. Description of Device (EUT).....	4
1.3. Auxiliary Equipment Used During Test.....	4
1.4. Description of Test Modes.....	5
1.5. Description Of Test Setup.....	6
1.6. Test Equipment List.....	7
1.7. Measurement Uncertainty.....	8
1.8. Description of Test Facility.....	8
2. Summary of Test Results.....	9
3. Conducted Emission Test.....	10
3.1. Test Standard and Limit.....	10
3.2. Test Setup.....	10
3.3. Test Procedure.....	10
3.4. Test Data.....	10
4. Radiation Spurious Emission and Band Edge.....	13
4.1. Test Standard and Limit.....	13
4.2. Test Setup.....	13
4.3. Test Procedure.....	14
4.4. Test Data.....	15
5. Antenna Requirement.....	19
5.1. Test Standard and Requirement.....	19
5.2. Antenna Connected Construction.....	19
APPENDIX I -- TEST SETUP PHOTOGRAPH.....	20
APPENDIX II -- EXTERNAL PHOTOGRAPH.....	22
APPENDIX III -- INTERNAL PHOTOGRAPH.....	26

TEST REPORT

Applicant : Anker Innovations Limited
Manufacturer : Anker Innovations Limited
Product Name : PowerWave Base Pad
Model No. : A2505
Trade Mark : ANKER
Rating(s) : Input: DC 5V, 2A, DC 9V, 2A
Wireless Output: 5W, 7.5W, 10W

Test Standard(s) : **FCC Part15 Subpart C 2018, Paragraph 15.209**
Test Method(s) : **ANSI C63.10: 2013**

The device described above is tested by Shenzhen Anbotek Compliance Laboratory Limited to determine the maximum emission levels emanating from the device and the severe levels of the device can endure and its performance criterion. The measurement results are contained in this test report and Shenzhen Anbotek Compliance Laboratory Limited is assumed full of responsibility for the accuracy and completeness of these measurements. Also, this report shows that the EUT (Equipment Under Test) is technically compliant with the FCC Part 15 Subpart C requirements.

This report applies to above tested sample only and shall not be reproduced in part without written approval of Shenzhen Anbotek Compliance Laboratory Limited.

Date of Receipt
Date of Test

Aug. 14, 2019
Aug. 14~22, 2019

Prepared By



Dolly Mo

(Engineer / Dolly Mo)

Reviewer

Snowy Meng

(Supervisor / Snowy Meng)

Approved & Authorized Signer

Sally Zhang

(Manager / Sally Zhang)

1. General Information

1.1. Client Information

Applicant	:	Anker Innovations Limited
Address	:	Room 1318-19, Hollywood Plaza, 610 Nathan Road, Mongkok, Kowloon, Hong Kong
Manufacturer	:	Anker Innovations Limited
Address	:	Room 1318-19, Hollywood Plaza, 610 Nathan Road, Mongkok, Kowloon, Hongkong
Factory	:	SHENZHEN RUIJING INDUSTRIAL CO., LTD
Address	:	Building C1, Hengli Industrial Park, Xiakeng 1st Road No.168, Longgang Street, Longgang District, Shenzhen, Guangdong, China

1.2. Description of Device (EUT)

Product Name	:	PowerWave Base Pad	
Model No.	:	A2505	
Trade Mark	:	ANKER	
Test Power Supply	:	AC 120V, 60Hz for adapter	
Test Sample No.	:	1-2-1(Normal Sample), 1-2-2(Engineering Sample)	
Product Description	:	Operation Frequency:	111-205KHz
		Modulation Type:	MSK
		Antenna Type:	Inductive loop coil Antenna
		Antenna Gain(Peak):	0 dBi

Remark: 1) For a more detailed features description, please refer to the manufacturer's specifications or the User's Manual.

1.3. Auxiliary Equipment Used During Test

Adapter	:	Manufacturer: Anker Innovations Limited
		M/N: A2013
		Input: 100-240V 50-60Hz 0.7A
		Output: 3.6-6.5V --- 3A/ 6.5-9V --- 2A/ 9-12V --- 1.5A

1.4. Description of Test Modes

To investigate the maximum EMI emission characteristics generates from EUT, the test system was pre-scanning tested base on the consideration of following EUT operation mode or test configuration mode which possible have effect on EMI emission level. Each of these EUT operation mode(s) or test configuration mode(s) mentioned above was evaluated respectively.

Pretest Mode	Description
Mode 1	Full load, wireless charger module

For Conducted Emission	
Final Test Mode	Description
Mode 1	Full load, wireless charger module

For Radiated Emission	
Final Test Mode	Description
Mode 1	Full load, wireless charger module

Note: (1)Test channel is 0.1499MHz.

(2) All the situation(full load, half load and empty load) has been tested,only the worst situation (full load) was recorded in the report.

(3)5W/ 7.5W/ 10W All modes have been tested. This report only show the test result of the worst case(Full load 10W).

1.5. Description Of Test Setup

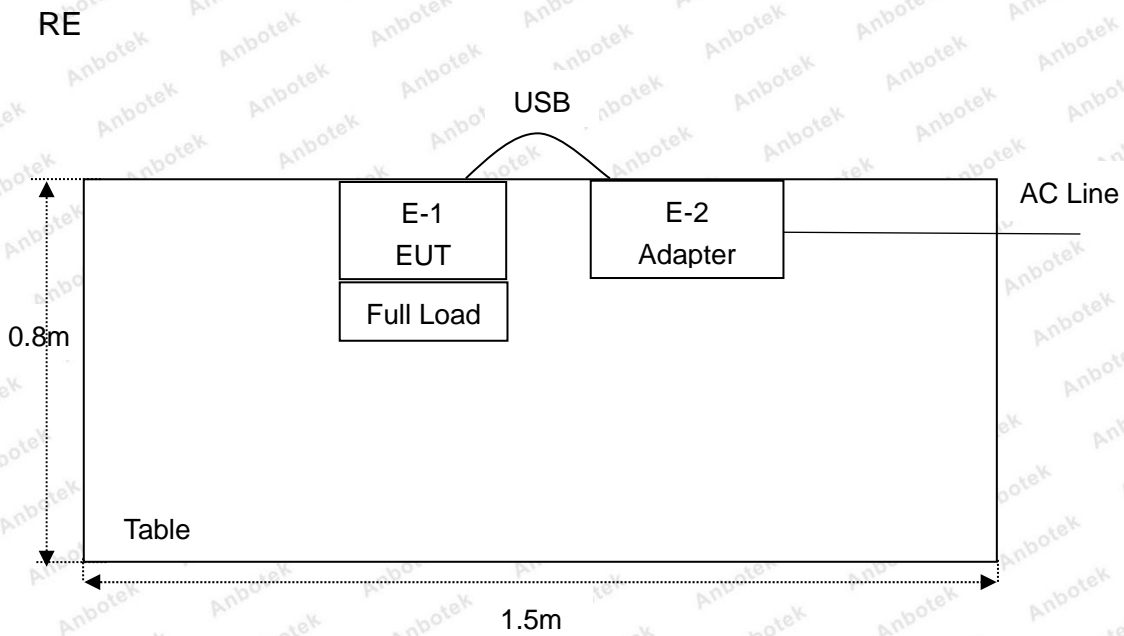
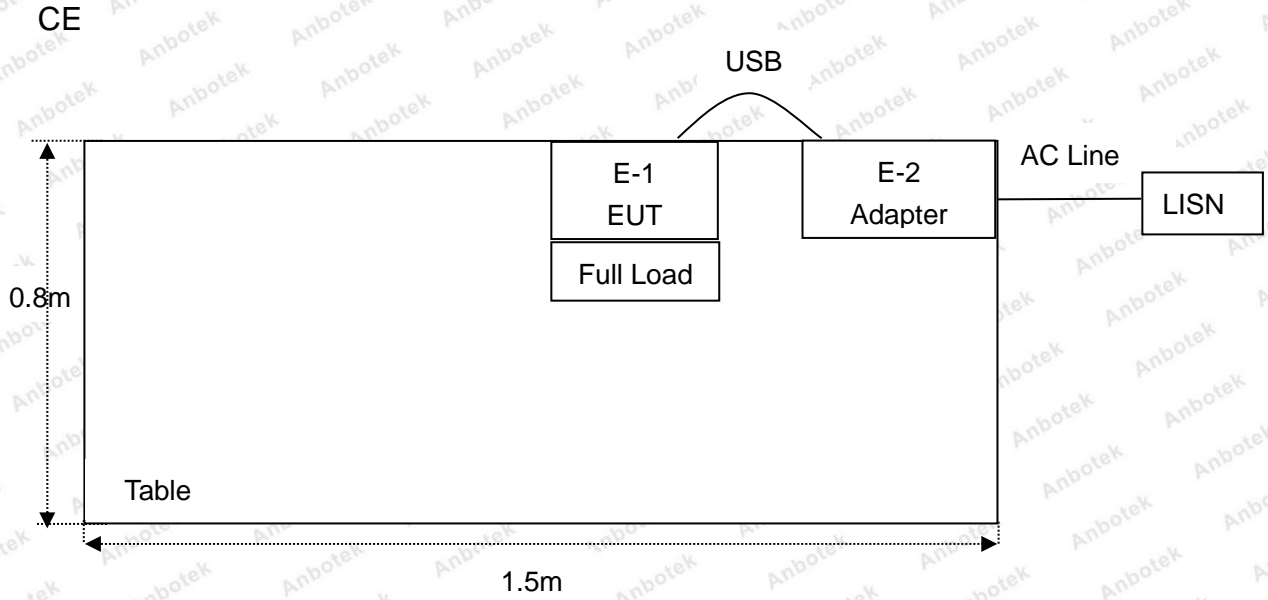

1.6. Test Equipment List

Item	Equipment	Manufacturer	Model No.	Serial No.	Last Cal.	Cal. Interval
1.	L.I.S.N. Artificial Mains Network	Rohde & Schwarz	ENV216	100055	Nov. 26, 2018	1 Year
2.	EMI Test Receiver	Rohde & Schwarz	ESPI3	101604	Nov. 05, 2018	1 Year
3.	RF Switching Unit	Compliance Direction	RSU-M2	38303	Nov. 05, 2018	1 Year
4.	Spectrum Analysis	Agilent	E4407B	US39390582	Nov. 05, 2018	1 Year
5.	MAX Spectrum Analysis	Agilent	N9020A	MY51170037	Nov. 05, 2018	1 Year
6.	Preamplifier	SKET Electronic	BK1G18G30 D	KD17503	Nov. 05, 2018	1 Year
7.	Double Ridged Horn Antenna	Instruments corporation	GTH-0118	351600	Nov. 20, 2018	1 Year
8.	Bilog Broadband Antenna	Schwarzbeck	VULB9163	VULB 9163-289	Nov. 19, 2018	1 Year
9.	Loop Antenna	Schwarzbeck	FMZB1519B	00053	Nov. 20, 2018	1 Year
10.	Horn Antenna	A-INFO	LB-180400- KF	J211060628	Nov. 20, 2018	1 Year
11.	Pre-amplifier	SONOMA	310N	186860	Nov. 05, 2018	1 Year
12.	EMI Test Software EZ-EMC	SHURPLE	N/A	N/A	N/A	N/A
13.	RF Test Control System	YIHENG	YH3000	2017430	Nov. 05, 2018	1 Year
14.	Power Sensor	DAER	RPR3006W	15I00041SN045	Nov. 05, 2018	1 Year
15.	Power Sensor	DAER	RPR3006W	15I00041SN046	Nov. 05, 2018	1 Year
16.	MXA Spectrum Analysis	Agilent	N9020A	MY51170037	Nov. 05, 2018	1 Year
17.	MXG RF Vector Signal Generator	Agilent	N5182A	MY48180656	Nov. 05, 2018	1 Year
18.	Signal Generator	Agilent	E4421B	MY41000743	Nov. 05, 2018	1 Year
19.	DC Power Supply	LW	TPR-6420D	374470	Oct. 31, 2018	1 Year
20.	Constant Temperature Humidity Chamber	ZHONGJIAN	ZJ-KHWS80 B	N/A	Nov. 01, 2018	1 Year

1.7. Measurement Uncertainty

Radiation Uncertainty	:	Ur = 3.9 dB (Horizontal)
		Ur = 3.8 dB (Vertical)
Conduction Uncertainty	:	Uc = 3.4 dB

1.8. Description of Test Facility

The test facility is recognized, certified, or accredited by the following organizations:

FCC-Registration No.: 184111

Shenzhen Anbotek Compliance Laboratory Limited, EMC Laboratory has been registered and fully described in a report filed with the (FCC) Federal Communications Commission. The acceptance letter from the FCC is maintained in our files. Registration No. 184111, September 30, 2018.

ISED-Registration No.: 8058A

Shenzhen Anbotek Compliance Laboratory Limited, EMC Laboratory has been registered and fully described in a report filed with the (ISED) Innovation, Science and Economic Development Canada. The acceptance letter from the ISED is maintained in our files. Registration 8058A, March 07, 2019.

Test Location

Shenzhen Anbotek Compliance Laboratory Limited.

1/F, Building D, Sogood Science and Technology Park, Sanwei community, Hangcheng Street, Bao'an District, Shenzhen, Guangdong, China.518102



2. Summary of Test Results

Standard Section	Test Item	Result
FCC Part 15, Paragraph 15.207	Conducted Emission Test	PASS
FCC Part 15, Paragraph 15.209(a)(f)	Spurious Emission	PASS
Part 15.203	Antenna Requirement	PASS

3. Conducted Emission Test

3.1. Test Standard and Limit

Test Standard	FCC Part15 Section 15.207		
Test Limit	Frequency	Maximum RF Line Voltage (dBuV)	
		Quasi-peak Level	Average Level
	150kHz~500kHz	66 ~ 56 *	56 ~ 46 *
	500kHz~5MHz	56	46
	5MHz~30MHz	60	50
Remark: (1) *Decreasing linearly with logarithm of the frequency. (2) The lower limit shall apply at the transition frequency.			

3.2. Test Setup

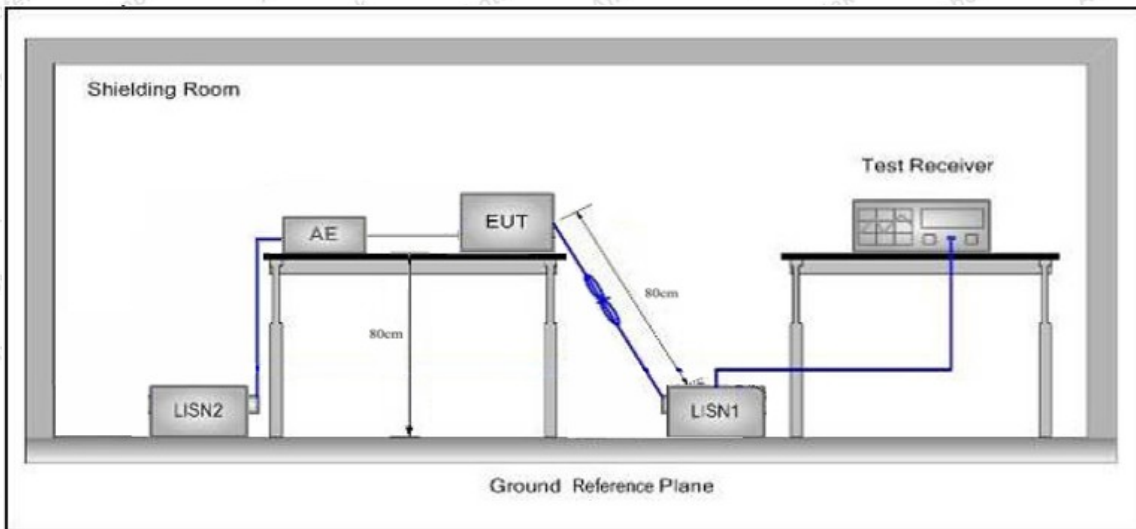

3.3. Test Procedure

The EUT system is connected to the power mains through a line impedance stabilization network (L.I.S.N.). This provides a 50ohm coupling impedance for the EUT system. Please refer the block diagram of the test setup and photographs. Both sides of AC line are checked to find out the maximum conducted emission. In order to find the maximum emission levels, the relative positions of equipment and all of the interface cables shall be changed according to FCC ANSI C63.10-2013 on Conducted Emission Measurement.

The bandwidth of test receiver (ESCI) set at 9kHz.

The frequency range from 150kHz to 30MHz is checked.

3.4. Test Data

Please to see the following pages

Conducted Emission Test Data

Test Site: 1# Shielded Room
 Operating Condition: Mode 1
 Test Specification: AC 120V, 60Hz for adapter
 Comment: Live Line
 Tem.: 22.7°C Hum.: 52%

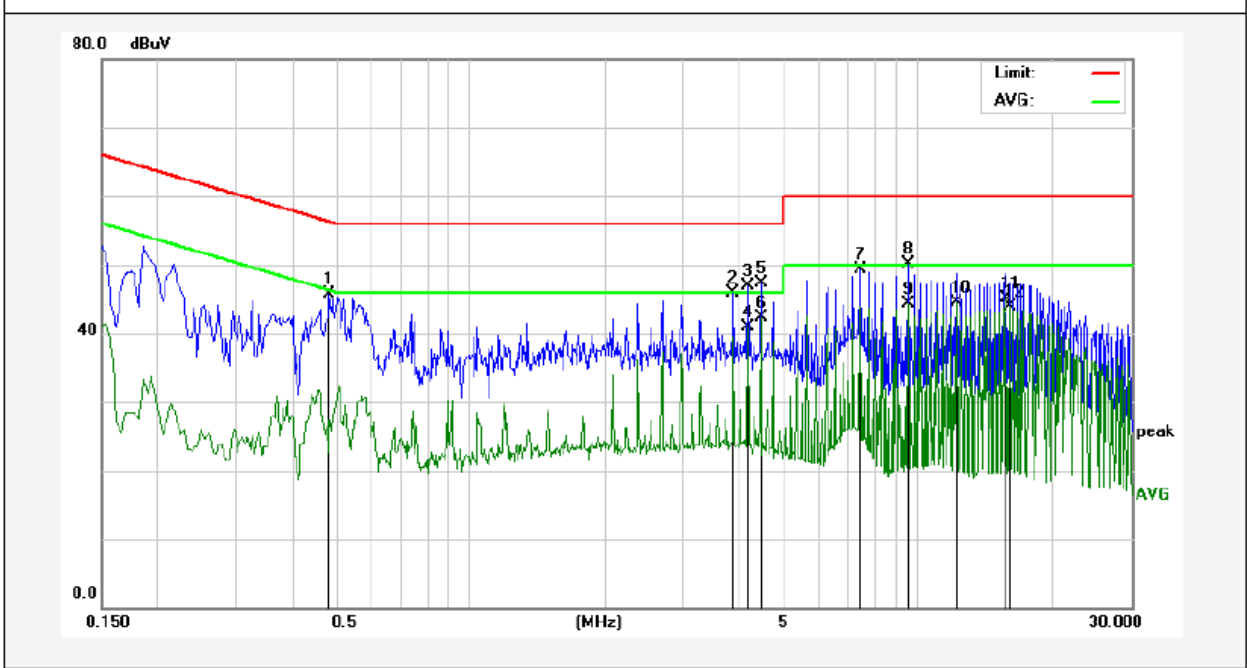

No.	Freq. (MHz)	Reading (dBuV)	Factor (dB)	Result (dBuV)	Limit dBuV	Over Limit (dB)	Detector	Remark
1	0.4860	25.67	19.97	45.64	56.24	-10.60	QP	
2	3.8660	25.64	20.18	45.82	56.00	-10.18	QP	
3	4.1620	26.80	20.18	46.98	56.00	-9.02	QP	
4	4.1620	20.76	20.18	40.94	46.00	-5.06	AVG	
5	4.4620	27.17	20.19	47.36	56.00	-8.64	QP	
6	4.4620	22.13	20.19	42.32	46.00	-3.68	AVG	
7	7.4500	29.11	20.27	49.38	60.00	-10.62	QP	
8	9.5180	29.68	20.33	50.01	60.00	-9.99	QP	
9	9.5180	24.05	20.33	44.38	50.00	-5.62	AVG	
10	12.1940	24.16	20.30	44.46	50.00	-5.54	AVG	
11	15.7620	24.85	20.27	45.12	50.00	-4.88	AVG	
12	16.0900	23.70	20.28	43.98	50.00	-6.02	AVG	

Conducted Emission Test Data

Test Site: 1# Shielded Room
 Operating Condition: Mode 1
 Test Specification: AC 120V, 60Hz for adapter
 Comment: Neutral Line
 Tem.: 22.7°C Hum.: 52%

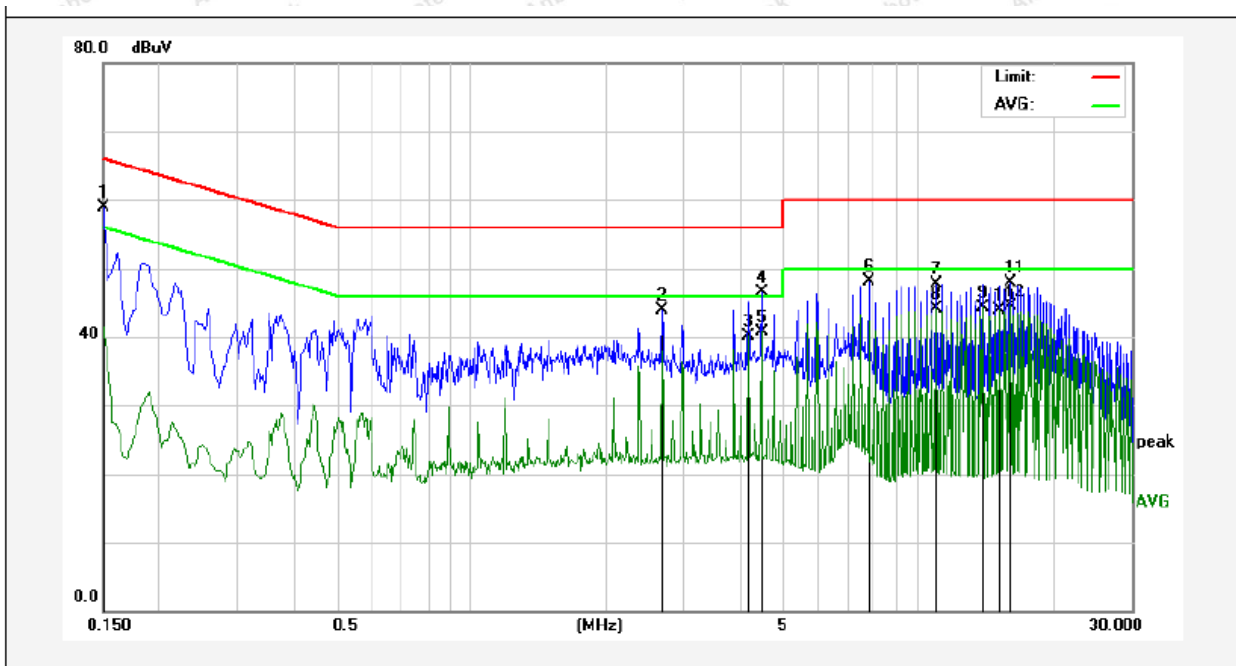

No.	Freq. (MHz)	Reading (dBuV)	Factor (dB)	Result (dBuV)	Limit dBuV	Over Limit (dB)	Detector	Remark
1	0.1500	38.93	19.90	58.83	65.99	-7.16	QP	
2	2.6780	23.80	20.15	43.95	56.00	-12.05	QP	
3	4.1620	19.92	20.18	40.10	46.00	-5.90	AVG	
4	4.4620	26.28	20.19	46.47	56.00	-9.53	QP	
5	4.4620	20.51	20.19	40.70	46.00	-5.30	AVG	
6	7.7340	27.85	20.28	48.13	60.00	-11.87	QP	
7	11.0020	27.48	20.32	47.80	60.00	-12.20	QP	
8	11.0020	23.75	20.32	44.07	50.00	-5.93	AVG	
9	13.9780	23.93	20.28	44.21	50.00	-5.79	AVG	
10	15.1660	23.73	20.26	43.99	50.00	-6.01	AVG	
11	16.0580	27.53	20.28	47.81	60.00	-12.19	QP	
12	16.0580	24.13	20.28	44.41	50.00	-5.59	AVG	

4. Radiation Spurious Emission and Band Edge

4.1. Test Standard and Limit

Test Standard	FCC Part15 C Section 15.209 and 15.205				
Test Limit	Frequency (MHz)	Field strength (microvolt/meter)	Limit (dBuV/m)	Remark	Measurement distance (m)
	0.009MHz~0.490MHz	2400/F(kHz)	-	-	300
	0.490MHz-1.705MHz	24000/F(kHz)	-	-	30
	1.705MHz-30MHz	30	-	-	30
	30MHz~88MHz	100	40.0	Quasi-peak	3
	88MHz~216MHz	150	43.5	Quasi-peak	3
	216MHz~960MHz	200	46.0	Quasi-peak	3
	960MHz~1000MHz	500	54.0	Quasi-peak	3
	Above 1000MHz	500	54.0	Average	3
-		74.0	Peak	3	

Remark:

- (1)The lower limit shall apply at the transition frequency.
- (2) 15.35(b), Unless otherwise specified, the limit on peak radio frequency emissions is 20dB above the maximum permitted average emission limit applicable to the equipment under test. This peak limit applies to the total peak emission level radiated by the device.

4.2. Test Setup

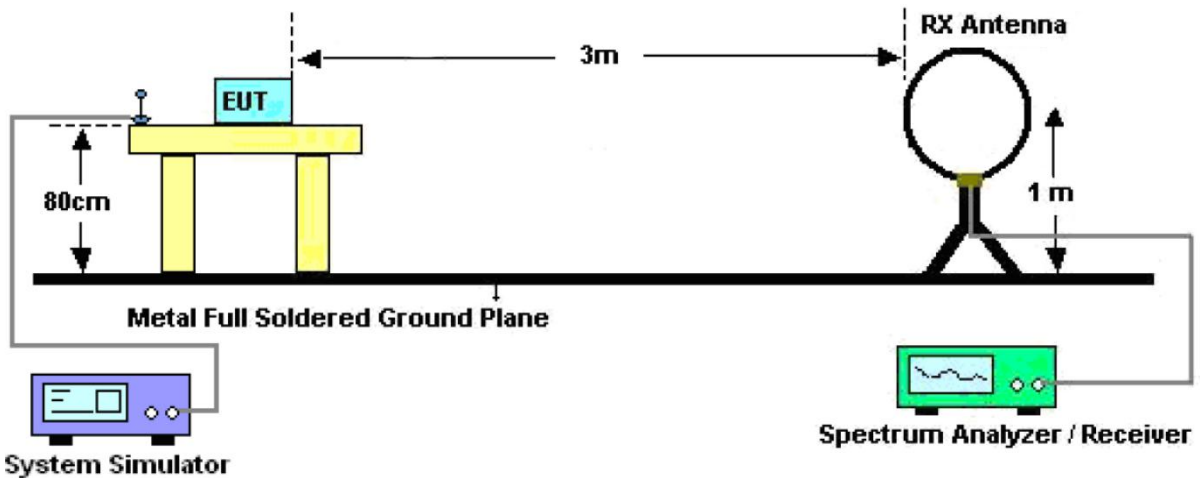

Figure 1. Below 30MHz

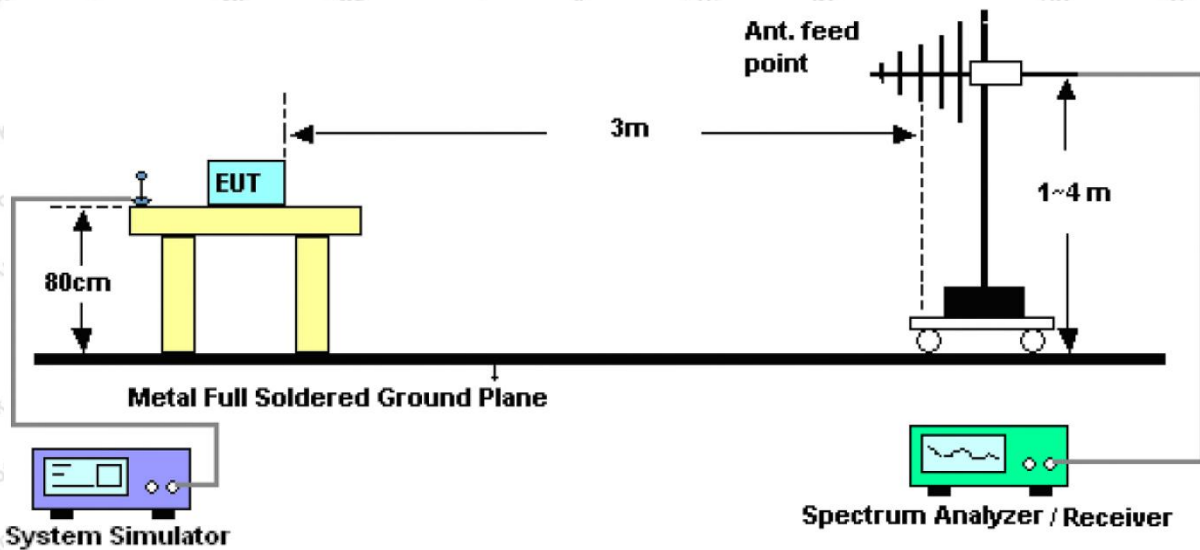

Figure 2. 30MHz to 1GHz

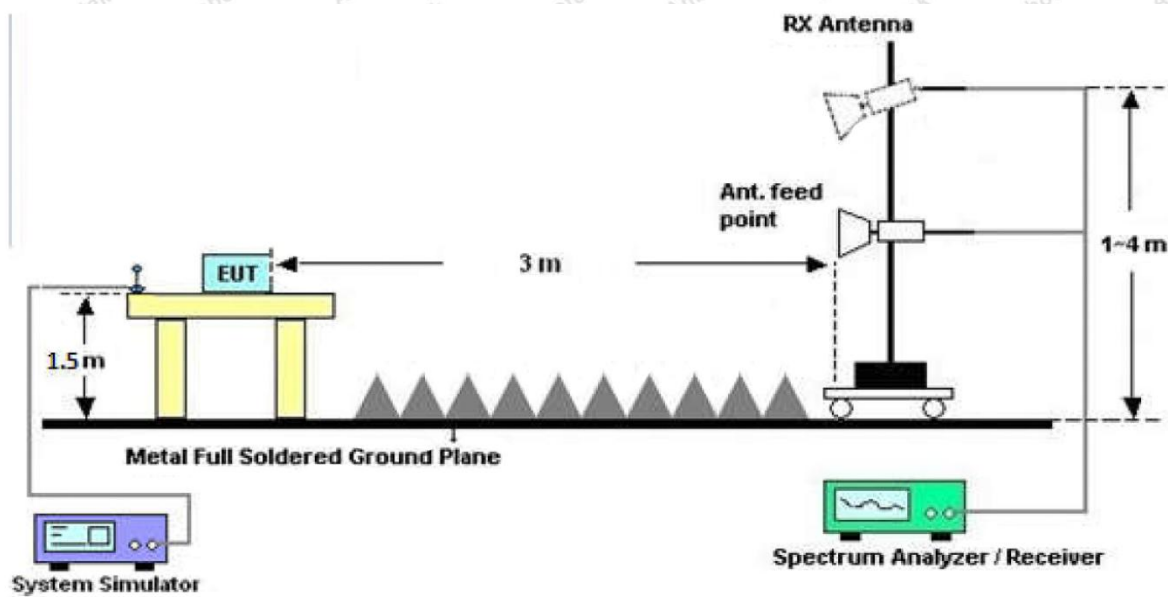

Figure 3. Above 1 GHz

4.3. Test Procedure

For below 1GHz: The EUT is placed on a turntable, which is 0.8m above the ground plane.

For above 1GHz: The EUT is placed on a turntable, which is 1.5m above the ground plane.

The turn table can rotate 360 degrees to determine the position of the maximum emission level. The EUT is set 3 meters away from the receiving antenna which is mounted on a antenna tower. The antenna can be moved up and down from 1 to 4 meters to find out the maximum emission level. Rotated the EUT through three orthogonal axes to determine the maximum emissions, both horizontal and vertical polarization of the antenna are set on test. The EUT is tested in 9*6*6 Chamber. The device is evaluated in xyz orientation.

Report No.: SZAWW190814019-01

FCC ID: 2AOKB-A2505

Page 15 of 29

For 9kHz to 150kHz, Set the spectrum analyzer as:

RBW = 200Hz, VBW = 1kHz, Detector= Quasi-Peak, Trace mode= Max hold, Sweep- auto couple.

For 150kHz to 30MHz, Set the spectrum analyzer as:

RBW = 9kHz, VBW = 30kHz, Detector= Quasi-Peak, Trace mode= Max hold, Sweep- auto couple.

For 30MHz to 1000MHz, Set the spectrum analyzer as:

RBW = 100kHz, VBW = 300kHz, Detector= Quasi-Peak, Trace mode= Max hold, Sweep- auto couple.

4.4. Test Data

PASS

Note: The data is in TX mode, and this is the worst mode.

Test Results

(Between 9KHz – 30MHz)

Job No.: SZAWW190814019-01
Standard: FCC PART15 C_3m **Power Source:** AC 120V, 60Hz for adapter
Test item: Radiation Test **Temp.(C)/Hum.(%RH):** 25.4°C/54%RH
Test Mode: Mode 1 **Distance:** 3m

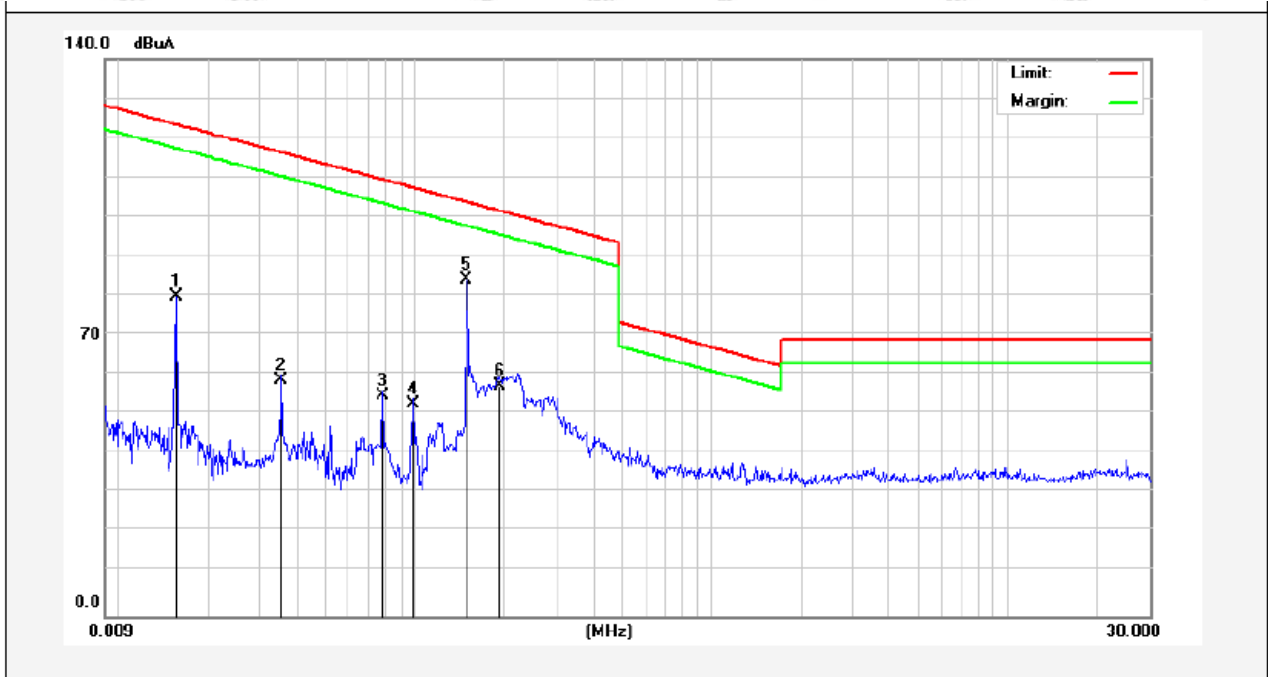

Frequency (MHz)	Read Level (dBuV)	Antenna Factor (dB/m)	Cable Loss (dB)	Preamp Factor (dB)	Level (dBuV/m)	Limit (dBuV/m)	Over Limit (dB)	Detector	degree
									(dge)
0.0158	61.84	19.27	2.53	0	83.64	143.46	-59.82	Peak	320
0.0158	58.41	19.27	2.53	0	80.21	123.46	-43.25	AV	320
0.0354	48.05	19.30	2.53	0	69.88	136.50	-66.62	Peak	141
0.0354	37.34	19.30	2.53	0	59.17	116.50	-57.33	AV	141
0.0782	43.57	19.35	2.55	0	65.47	129.65	-64.18	Peak	39
0.0782	33.71	19.35	2.55	0	55.61	109.65	-54.04	AV	39
0.0990	40.89	19.35	2.55	0	62.79	127.61	-64.82	Peak	124
0.0990	31.44	19.35	2.55	0	53.34	107.61	-54.27	AV	124
0.1499	62.33	19.62	2.59	0	84.54	124.03	-39.49	Peak	245
0.1499	59.42	19.62	2.59	0	81.63	104.03	-22.40	AV	245
0.1940	43.78	20.73	2.60	0	67.11	121.80	-54.69	Peak	100
0.1940	34.68	20.73	2.60	0	58.01	101.80	-43.79	AV	100

Remark: According to FCC PART 15.209 (d), the emission limits for the frequency bands 9–90 kHz, 110–490 kHz and above 1000 MHz, Radiated emission limits in these three bands are based on measurements employing an average detector.

(Between 30MHz –1000 MHz)

Job No.:	SZAWW190814019-01	Polarization:	Horizontal
Standard:	FCC PART15 C_3m	Power Source:	AC 120V, 60Hz for adapter
Test item:	Radiation Test	Temp.(C)/Hum.(%RH):	23.7°C/51%RH
Test Mode:	Mode 1	Distance:	3m

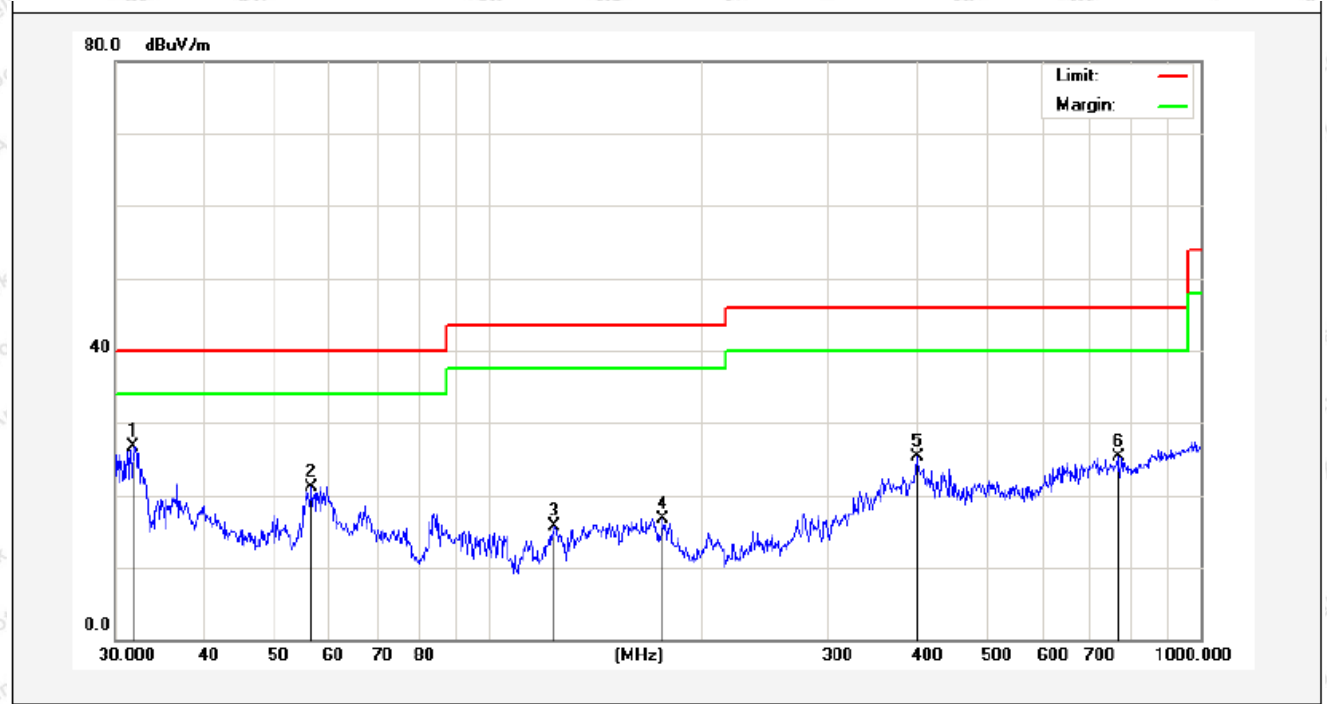

No.	Freq. (MHz)	Reading (dBuV)	Factor (dB/m)	Result (dBuV/m)	Limit (dBuV/m)	Over Limit (dB)	Detector	Height (cm)	degree (deg)	Remark
1	31.8427	45.73	-18.93	26.80	40.00	-13.20	QP	300	360	
2	56.5929	39.25	-18.16	21.09	40.00	-18.91	QP	300	0	
3	124.1330	39.35	-23.55	15.80	43.50	-27.70	QP	300	360	
4	176.2686	38.40	-21.67	16.73	43.50	-26.77	QP	300	0	
5	400.4319	39.45	-14.13	25.32	46.00	-20.68	QP	300	360	
6	766.0571	33.47	-8.22	25.25	46.00	-20.75	QP	300	0	

Job No.: SZAWW190814019-01 **Polarization:** Vertical
Standard: FCC PART15 C_3m **Power Source:** AC 120V, 60Hz for adapter
Test item: Radiation Test **Temp.(C)/Hum.(%RH):** 23.7°C/51%RH
Test Mode: Mode 1 **Distance:** 3m

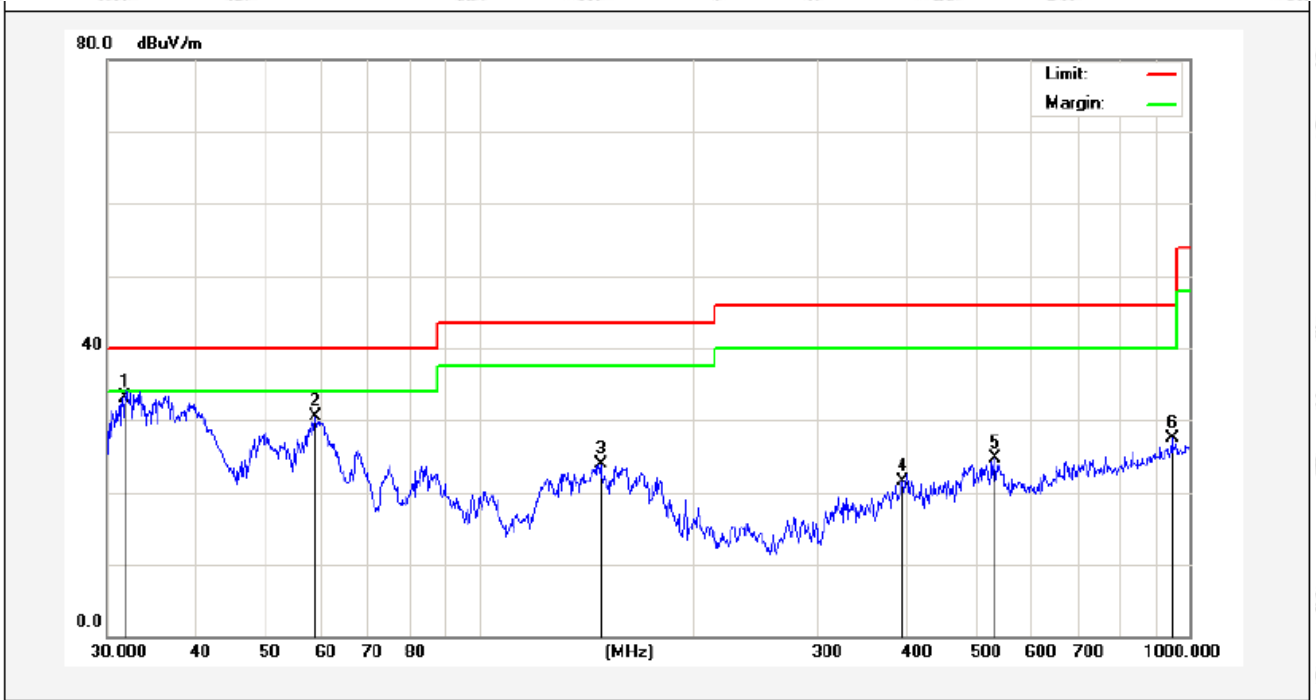

No.	Freq. (MHz)	Reading (dBuV)	Factor (dB/m)	Result (dBuV/m)	Limit (dBuV/m)	Over Limit (dB)	Detector	Height (cm)	degree (deg)	Remark
1	31.8427	51.05	-17.93	33.12	40.00	-6.88	QP	100	360	
2	58.8185	47.85	-17.32	30.53	40.00	-9.47	QP	100	0	
3	148.4410	43.24	-19.36	23.88	43.50	-19.62	QP	100	360	
4	394.8545	34.72	-13.22	21.50	46.00	-24.50	QP	100	0	
5	531.9635	36.32	-11.64	24.68	46.00	-21.32	QP	100	360	
6	945.4399	31.83	-4.31	27.52	46.00	-18.48	QP	100	0	

5. Antenna Requirement

5.1. Test Standard and Requirement

Test Standard	FCC Part15 Section 15.203
Requirement	An intentional radiator shall be designed to ensure that no antenna other than that furnished by the responsible party shall be used with the device. The use of a permanently attached antenna or of an antenna that uses a unique coupling to the intentional radiator, the manufacturer may design the unit so that a broken antenna can be replaced by the user, but the use of a standard antenna jack or electrical connector is prohibited.

5.2. Antenna Connected Construction

The antenna is a Inductive loop coil Antenna which permanently attached, and the best case gain of the antenna is 0 dBi. It complies with the standard requirement.

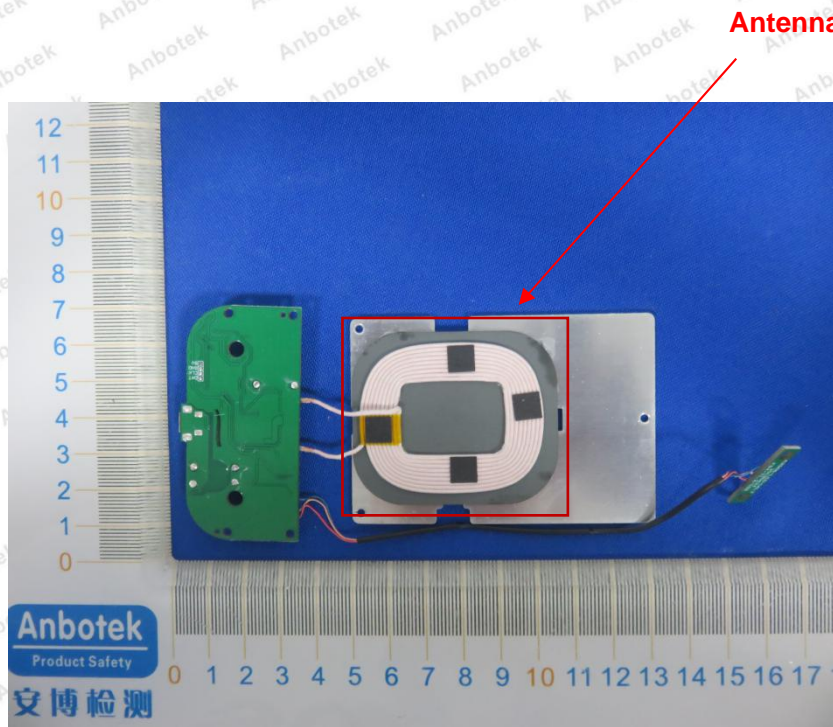

APPENDIX I -- TEST SETUP PHOTOGRAPH

Photo of Conducted Emission Measurement



Photo of Radiation Emission Test





APPENDIX II -- EXTERNAL PHOTOGRAPH









APPENDIX III -- INTERNAL PHOTOGRAPH

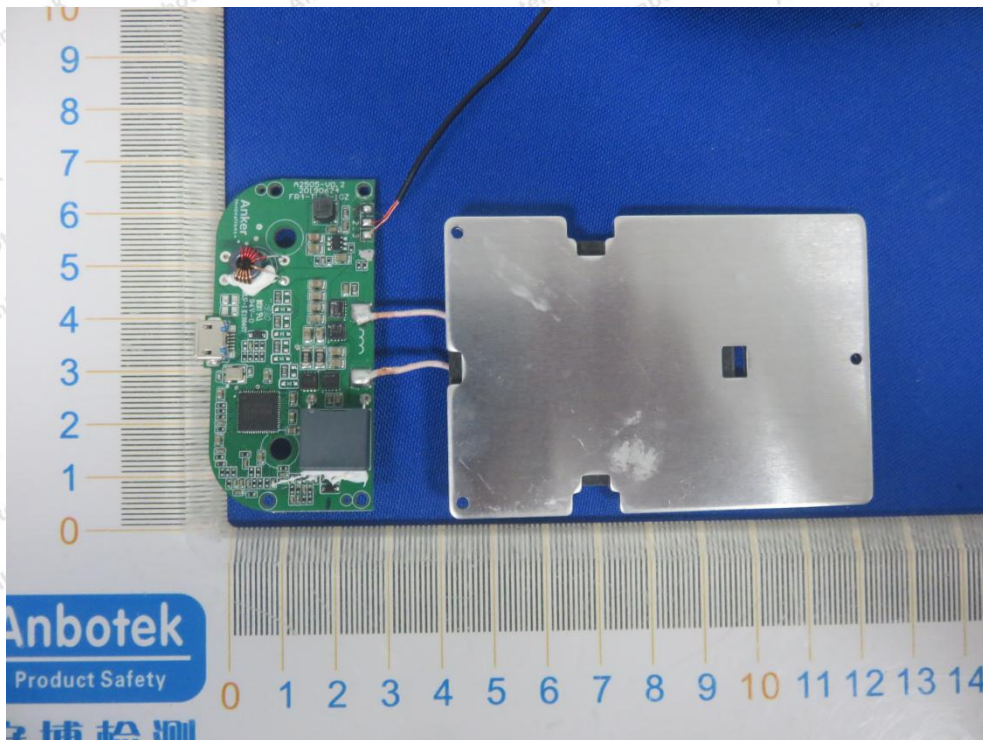

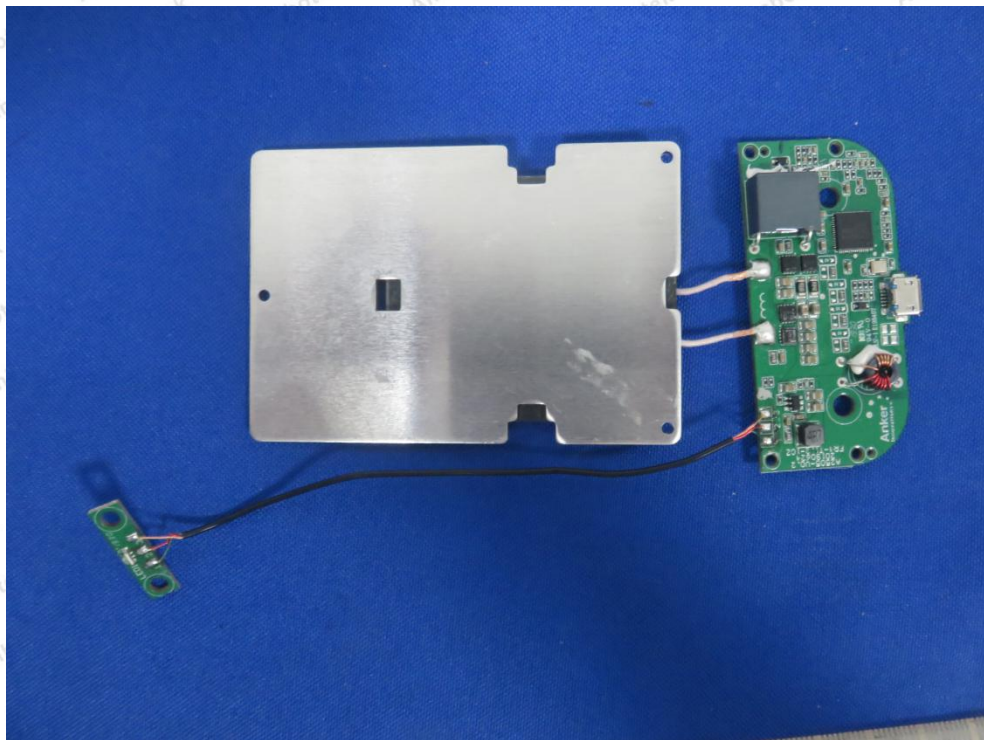
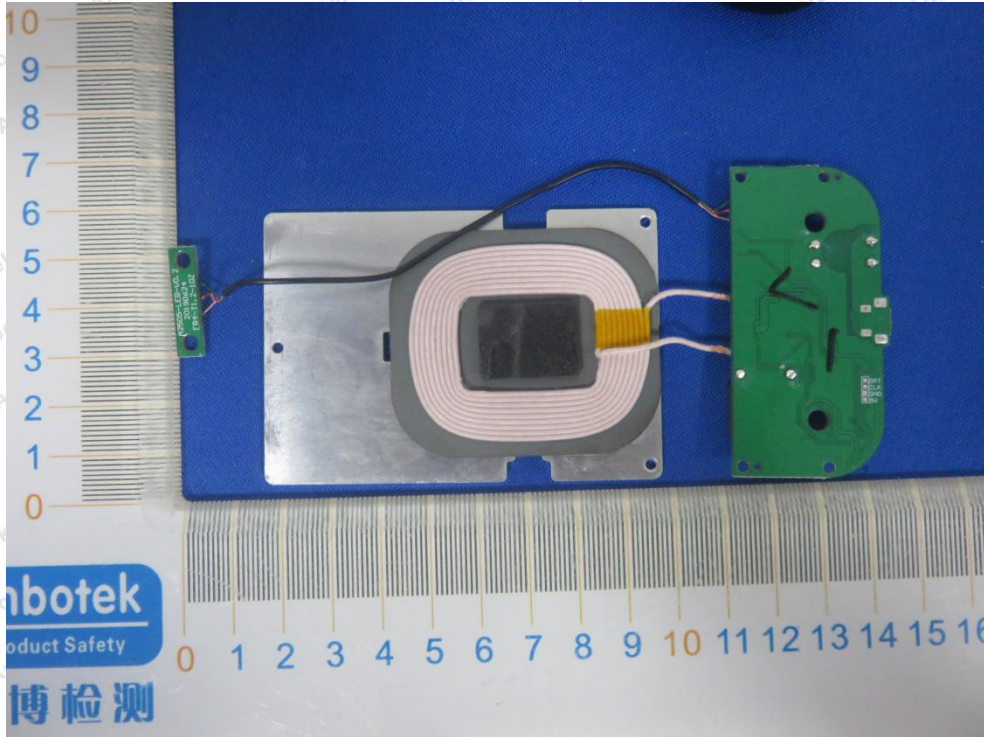

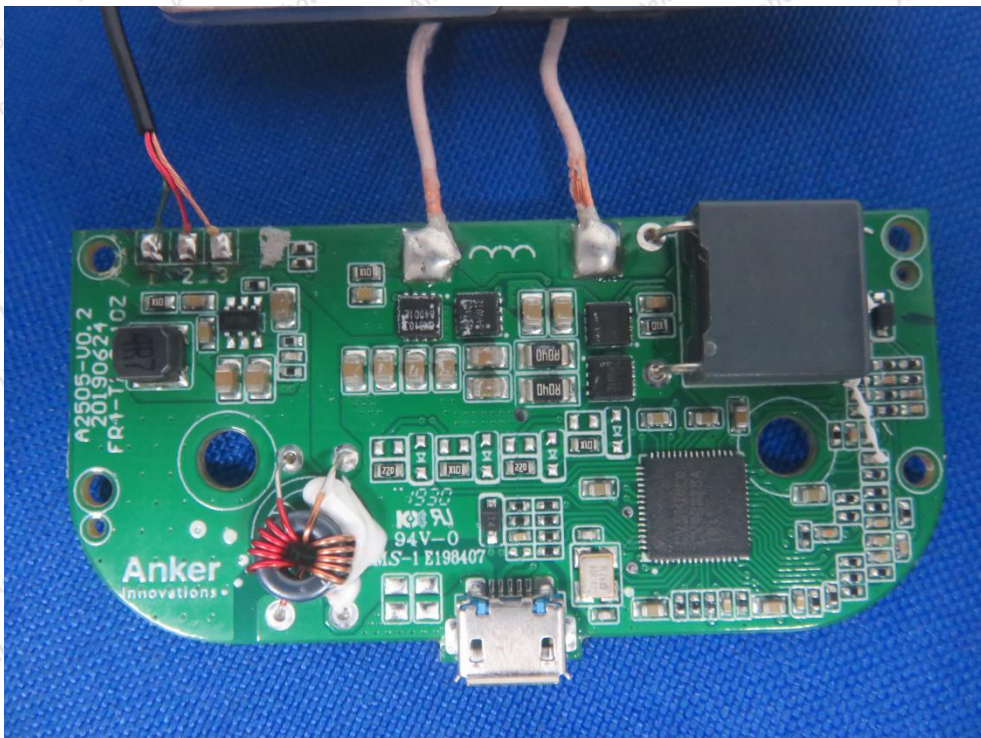
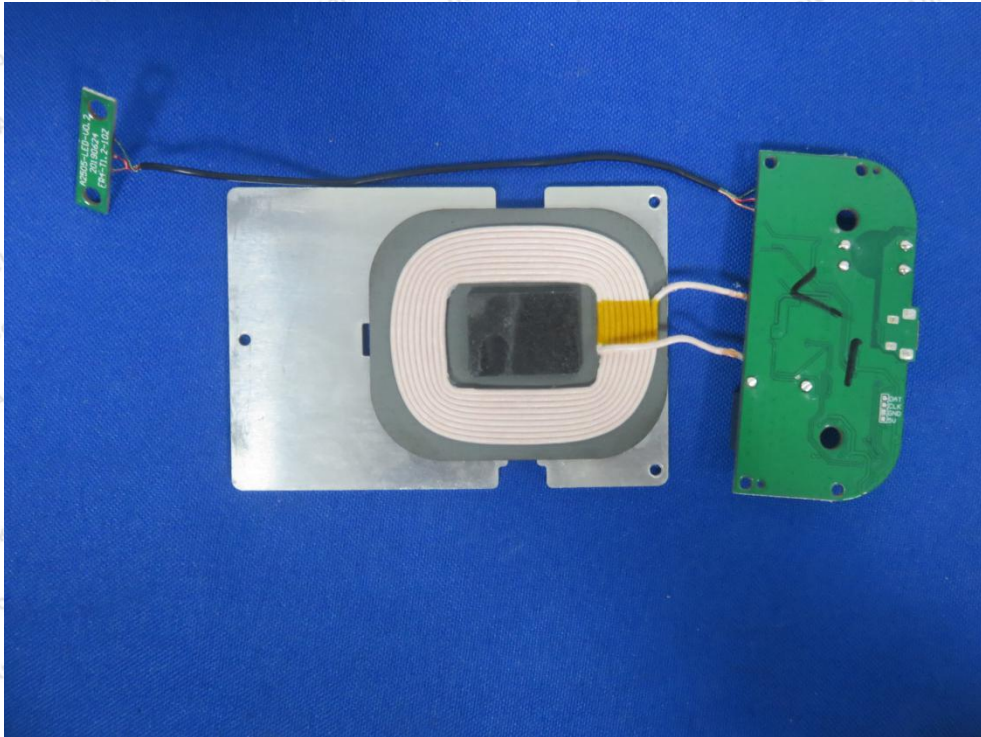

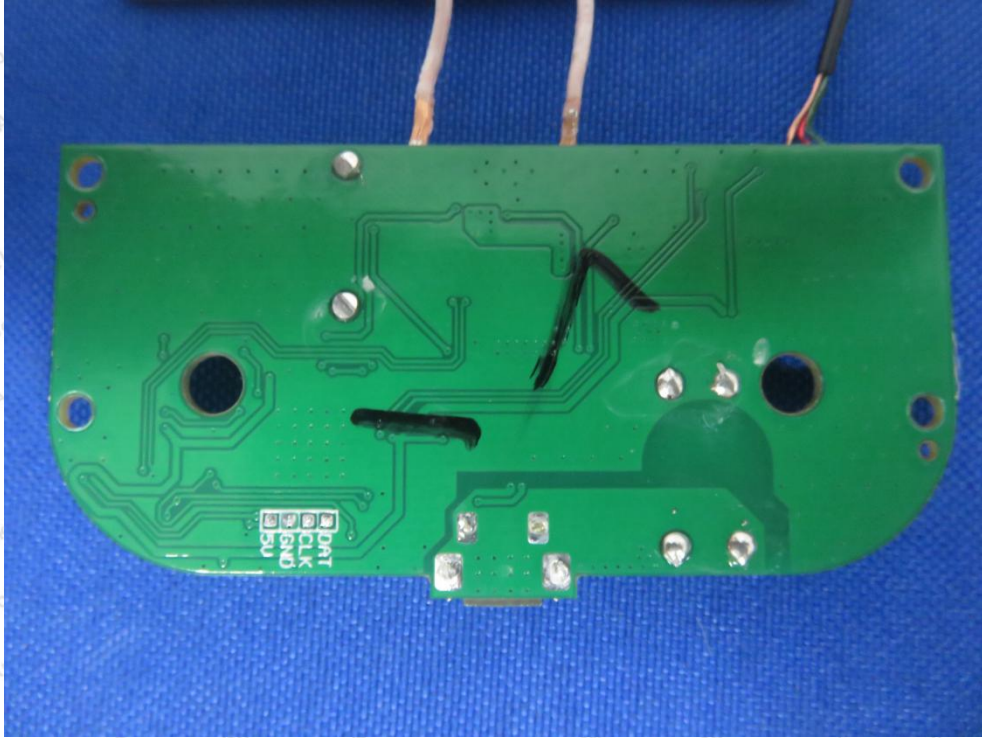

----- End of Report -----