

FCC Test Report

Applicant : **Anker Innovations Limited**

Address : **Room 1318-19, Hollywood Plaza, 610 Nathan Road, Mongkok, Kowloon, Hongkong**

Product Name : **Anker SOLIX C800 PLUS Portable Power Station**

Report Date : **Nov. 01, 2023**

Shenzhen Anbotek Compliance Laboratory Limited



Shenzhen Anbotek Compliance Laboratory Limited

Address: 1/F., Building D, Sogood Science and Technology Park, Sanwei Community, Hangcheng Street, Bao'an District, Shenzhen, Guangdong, China.
Tel: (86)0755-26066440 Fax: (86)0755-26014772 Email: service@anbotek.com



Hotline
400-003-0500
www.anbotek.com.cn



Contents

1. General Information	6
1.1. Client Information	6
1.2. Description of Device (EUT)	6
1.3. Auxiliary Equipment Used During Test	8
1.4. Operation channel list	9
1.5. Description of Test Modes	9
1.6. Measurement Uncertainty	9
1.7. Test Summary	10
1.8. Description of Test Facility	11
1.9. Disclaimer	11
1.10. Test Equipment List	12
2. Antenna requirement	14
2.1. Conclusion	14
3. Conducted Emission at AC power line	15
3.1. EUT Operation	15
3.2. Test Setup	15
3.3. Test Data	16
4. Occupied Bandwidth	18
4.1. EUT Operation	18
4.2. Test Setup	18
4.3. Test Data	18
5. Maximum Conducted Output Power	19
5.1. EUT Operation	19
5.2. Test Setup	19
5.3. Test Data	19
6. Power Spectral Density	20
6.1. EUT Operation	20
6.2. Test Setup	20
6.3. Test Data	20
7. Emissions in non-restricted frequency bands	21
7.1. EUT Operation	21
7.2. Test Setup	21
7.3. Test Data	21
8. Band edge emissions (Radiated)	22
8.1. EUT Operation	22
8.2. Test Setup	22
8.3. Test Data	23
9. Emissions in frequency bands (below 1GHz)	25
9.1. EUT Operation	25
9.2. Test Setup	26
9.3. Test Data	27

Shenzhen Anbotek Compliance Laboratory Limited

Address: 1/F., Building D, Sogood Science and Technology Park, Sanwei Community,
Hangcheng Street, Bao'an District, Shenzhen, Guangdong, China.
Tel: (86)0755-26066440 Fax: (86)0755-26014772 Email: service@anbotek.com



Hotline
400-003-0500
www.anbotek.com.cn



10. Emissions in frequency bands (above 1GHz).....	29
10.1. EUT Operation.....	29
10.2. Test Setup.....	29
10.3. Test Data.....	30
APPENDIX I -- TEST SETUP PHOTOGRAPH.....	33
APPENDIX II -- EXTERNAL PHOTOGRAPH.....	33
APPENDIX III -- INTERNAL PHOTOGRAPH.....	33

Shenzhen Anbotek Compliance Laboratory Limited

Address: 1/F., Building D, Sogood Science and Technology Park, Sanwei Community, Hangcheng Street, Bao'an District, Shenzhen, Guangdong, China.
Tel: (86)0755-26066440 Fax: (86)0755-26014772 Email: service@anbotek.com



Hotline
400-003-0500
www.anbotek.com.cn



Report No.: 18220WC30227501

FCC ID: 2AOKB-A1754

Page 4 of 33

TEST REPORT

Applicant : Anker Innovations Limited
Manufacturer : Anker Innovations Limited
Product Name : Anker SOLIX C800 PLUS Portable Power Station
Test Model No. : A1754
Reference Model No. : N/A
Trade Mark : ANKER
Rating(s) : Please refer to page 7
Test Standard(s) : 47 CFR Part 15.247

The device described above is tested by Shenzhen Anbotek Compliance Laboratory Limited to determine the maximum emission levels emanating from the device and the severe levels of the device can endure and its performance criterion. The measurement results are contained in this test report and Shenzhen Anbotek Compliance Laboratory Limited is assumed full of responsibility for the accuracy and completeness of these measurements. Also, this report shows that the EUT (Equipment Under Test) is technically compliant with above listed standard(s) requirements. This report applies to above tested sample only and shall not be reproduced in part without written approval of Shenzhen Anbotek Compliance Laboratory Limited.

Date of Receipt:

Oct. 27, 2023

Date of Test:

Oct. 27, 2023 to Oct. 30, 2023

Prepared By:



(TuTu Hong)

Approved & Authorized Signer:



(Edward Pan)

Shenzhen Anbotek Compliance Laboratory Limited

Address: 1/F., Building D, Sogood Science and Technology Park, Sanwei Community, Hangcheng Street, Bao'an District, Shenzhen, Guangdong, China.
Tel: (86)0755-26066440 Fax: (86)0755-26014772 Email: service@anbotek.com



Hotline

400-003-0500

www.anbotek.com.cn

安博
检测

Revision History

Report Version	Description	Issued Date
R00	Original Issue.	Nov. 01, 2023

Shenzhen Anbotek Compliance Laboratory Limited

Address: 1/F., Building D, Sogood Science and Technology Park, Sanwei Community, Hangcheng Street, Bao'an District, Shenzhen, Guangdong, China.
Tel: (86)0755-26066440 Fax: (86)0755-26014772 Email: service@anbotek.com



Hotline
400-003-0500
www.anbotek.com.cn



1. General Information

1.1. Client Information

Applicant	:	Anker Innovations Limited
Address	:	Room 1318-19, Hollywood Plaza, 610 Nathan Road, Mongkok, Kowloon, Hongkong
Manufacturer	:	Anker Innovations Limited
Address	:	Room 1318-19, Hollywood Plaza, 610 Nathan Road, Mongkok, Kowloon, Hongkong

1.2. Description of Device (EUT)

Product Name	:	Anker SOLIX C800 PLUS Portable Power Station
Test Model No.	:	A1754
Reference Model No.	:	N/A
Trade Mark	:	ANKER
Test Power Supply	:	AC 120V/60Hz/DC 51.2V battery inside
Test Sample No.	:	1-2-1(Normal Sample), 1-2-2(Engineering Sample)
Adapter	:	N/A
RF Specification		
Operation Frequency	:	2402~2480MHZ
Number of Channel	:	40
Modulation Type	:	GFSK
Antenna Type	:	FPC Antenna
Antenna Gain(Peak)	:	3.65dBi
Remark:		
(1) All of the RF specification are provided by customer.		
(2) For a more detailed features description, please refer to the manufacturer's specifications or the User's Manual.		

Shenzhen Anbotek Compliance Laboratory Limited

Address: 1/F., Building D, Sogood Science and Technology Park, Sanwei Community, Hangcheng Street, Bao'an District, Shenzhen, Guangdong, China.
Tel: (86)0755-26066440 Fax: (86)0755-26014772 Email: service@anbotek.com



Hotline
400-003-0500
www.anbotek.com.cn



Rating(s):

Anker SOLIX C800 PLUS Portable Power Station

Model: A1754

Rated Capacity: 51.2Vdc 15000mAh/768Wh

AC Input Voltage: 100-120V~ 12A Max, 50Hz/60Hz

AC Input Power (Charging): 750W Max

AC Input Power (Bypass Mode): 1440W Max

AC Input Power (Ultra fast Charging): 1100W Max

XT60 Input: 11-60V~10A (300W Max) Car Charger Output: 12V~10A

USB-A Output: 5V~2.4A Per Port

USB-C Output 1: 5V~3A / 9V~3A / 15V~3A / 20V~3A / 20V~5A (100W Max)

USB-C Output 2: 5V~3A / 9V~3A / 12V~2.5A (30W Max)

Camping Light Charger Output: 5V~1A Per Port

AC Output (Bypass Mode): 100-120V~ 12A Max, 1440VA/1440W Max

AC Output (Inverter Mode): 120V~ 10A, 60Hz, 1200W Max

Discharging Temperature: -4°F-104°F / -20°C-40°C

Charging Temperature: 32°F-104°F / 0°C-40°C

FCC ID: 2AOKB-A1754 IC: 23451-A1754 CAN ICES-003 (B)/NMB-003(B)

Anker Innovations Limited I Made in China

Address: Room 1318-19, Hollywood Plaza, 610 Nathan Road, Mongkok, Kowloon, Hong Kong

The device complies with part 15 of the FCC Rules. Operation is subject to the following two conditions: (1) This device may not cause harmful interference, and (2) this device must accept any interferences received, including interference that may cause undesired operation.

WARNING - Do not overcharge the internal battery. See Instruction Manual. Do not smoke, drink, or eat in the vicinity of the power pack. Only charge the internal battery in a well ventilated area.

WARNING: Risk of Electric Shock and Risk of Fire. This device is not to be stored in a vehicle.

CAUTION - Risk of Injury To Persons. Do not use this product if the power cord or the battery cables are damaged in any way.

CAUTION - This device is not intended for use in a commercial repair facility.

CAUTION: Risk of Electric Shock. Connect only to properly grounded outlets.

DANGER! This device is not waterproof. Use indoors if it is raining or the ground is wet outside.

AVERTISSEMENT - Ne pas surcharger la batterie interne. Consulter le manuel d'utilisation.

Il ne faut pas fumer, allumer une allumette ou produire des étincelles à proximité du bloc d'alimentation. Charger la batterie uniquement dans un endroit bien aéré.

MISE EN GARDE: Risque de blessure aux personnes. Ne pas utiliser ce produit si le cordon d'alimentation ou les câbles de batterie sont endommagés de quelque façon.

MISE EN GARDE: Le dispositif n'est pas destiné à être utilisé dans un atelier de réparation commercial.

MISE EN GARDE: Risque de décharge électrique. Brancher l'uni té uniquement à des prises de courant correctement mises à la masse.

DANGER! Cet appareil n'est pas étanche. Utilisez-le à l'intérieur s'il pleut ou si le sol est humide à l'extérieur.



ALWAYS HERE TO HELP

<https://www.anker.com>



support@anker.com
support.me@anker.com
CED-CN@anker.com

(US/CA)+1 (800)988 7973 English only

(États-Unis/Canada)+1 (800)988 7973 Anglais seulement

(UK) +44(0)1604 936200 (AU) +61 3 8331 4800

(DE) +49(0)69 9579 7960 (中国)+86 400 0550 036

(日本) 03 4455 7823 (MEA) +971 42428633

Shenzhen Anbotek Compliance Laboratory Limited

Address: 1/F., Building D, Sogood Science and Technology Park, Sanwei Community, Hangcheng Street, Bao'an District, Shenzhen, Guangdong, China.

Tel: (86)0755-26066440 Fax: (86)0755-26014772 Email: service@anbotek.com



Hotline

400-003-0500

www.anbotek.com.cn



1.3. Auxiliary Equipment Used During Test

Title	Manufacturer	Model No.	Serial No.
/	/	/	/

Shenzhen Anbotek Compliance Laboratory Limited

Address: 1/F., Building D, Sogood Science and Technology Park, Sanwei Community, Hangcheng Street, Bao'an District, Shenzhen, Guangdong, China.
Tel: (86)0755-26066440 Fax: (86)0755-26014772 Email: service@anbotek.com



Hotline
400-003-0500
www.anbotek.com.cn



1.4. Operation channel list

Channel	Frequency (MHz)	Channel	Frequency (MHz)	Channel	Frequency (MHz)	Channel	Frequency (MHz)
0	2402	10	2422	20	2442	30	2462
1	2404	11	2424	21	2444	31	2464
2	2406	12	2426	22	2446	32	2466
3	2408	13	2428	23	2448	33	2468
4	2410	14	2430	24	2450	34	2470
5	2412	15	2432	25	2452	35	2472
6	2414	16	2434	26	2454	36	2474
7	2416	17	2436	27	2456	37	2476
8	2418	18	2438	28	2458	38	2478
9	2420	19	2440	29	2460	39	2480

1.5. Description of Test Modes

Pretest Modes	Descriptions
TM1	Keep the EUT in continuously transmitting mode (BLE 1M)
TM2	Keep the EUT in continuously transmitting mode (BLE 2M)

1.6. Measurement Uncertainty

Parameter	Uncertainty
Conducted emissions (AMN 150kHz~30MHz)	3.8dB
Occupied Bandwidth	925Hz
Conducted Output Power	0.76dB
Conducted Spurious Emission	1.24dB
Radiated spurious emissions (above 1GHz)	1G-6GHz: 4.78dB; 6G-18GHz: 4.88dB 18G-40GHz: 5.68dB
Radiated emissions (Below 30MHz)	3.53dB
Radiated spurious emissions (30MHz~1GHz)	Horizontal: 3.92dB; Vertical: 4.52dB
The measurement uncertainty and decision risk evaluated according to AB/WI-RF-F-032. This uncertainty represents an expanded uncertainty expressed at approximately the 95% confidence level using a coverage factor of k=2.	

Shenzhen Anbotek Compliance Laboratory Limited

Address: 1/F., Building D, Sogood Science and Technology Park, Sanwei Community, Hangcheng Street, Bao'an District, Shenzhen, Guangdong, China.
Tel: (86)0755-26066440 Fax: (86)0755-26014772 Email: service@anbotek.com



Hotline
400-003-0500
www.anbotek.com.cn



1.7. Test Summary

Test Items	Test Modes	Status
Antenna requirement	/	P
Conducted Emission at AC power line	Mode1,2	P
Occupied Bandwidth	Mode1,2	P
Maximum Conducted Output Power	Mode1,2	P
Power Spectral Density	Mode1,2	P
Emissions in non-restricted frequency bands	Mode1,2	P
Band edge emissions (Radiated)	Mode1,2	P
Emissions in frequency bands (below 1GHz)	Mode1,2	P
Emissions in frequency bands (above 1GHz)	Mode1,2	P
Note: P: Pass N: N/A, not applicable		

Shenzhen Anbotek Compliance Laboratory Limited

Address: 1/F., Building D, Sogood Science and Technology Park, Sanwei Community,
Hangcheng Street, Bao'an District, Shenzhen, Guangdong, China.
Tel: (86)0755-26066440 Fax: (86)0755-26014772 Email: service@anbotek.com



Hotline
400-003-0500
www.anbotek.com.cn



1.8. Description of Test Facility

The test facility is recognized, certified, or accredited by the following organizations:

FCC-Registration No.:184111

Shenzhen Anbotek Compliance Laboratory Limited, EMC Laboratory has been registered and fully described in a report filed with the (FCC) Federal Communications Commission. The acceptance letter from the FCC is maintained in our files. Registration No. 184111.

ISED-Registration No.: 8058A

Shenzhen Anbotek Compliance Laboratory Limited, EMC Laboratory has been registered and fully described in a report filed with the (ISED) Innovation, Science and Economic Development Canada. The acceptance letter from the ISED is maintained in our files. Registration 8058A.

Test Location

Shenzhen Anbotek Compliance Laboratory Limited.

1/F, Building D, Sogood Science and Technology Park, Sanwei community, Hangcheng Street, Bao'an District, Shenzhen, Guangdong, China.518128

1.9. Disclaimer

1. The test report is invalid if not marked with the signatures of the persons responsible for preparing and approving the test report.
2. The test report is invalid if there is any evidence and/or falsification.
3. The results documented in this report apply only to the tested sample, under the conditions and modes of operation as described herein.
4. This document may not be altered or revised in any way unless done so by Anbotek and all revisions are duly noted in the revisions section.
5. Content of the test report, in part or in full, cannot be used for publicity and/or promotional purposes without prior written approval from the laboratory.
6. The authenticity of the information provided by the customer is the responsibility of the customer and the laboratory is not responsible for its authenticity.

The laboratory is only responsible for the data released by the laboratory, except for the part provided by the applicant.

Shenzhen Anbotek Compliance Laboratory Limited

Address:1/F.,Building D,Sogood Science and Technology Park, Sanwei Community,
Hangcheng Street, Bao'an District, Shenzhen, Guangdong, China.
Tel:(86)0755-26066440 Fax:(86)0755-26014772 Email:service@anbotek.com



Hotline
400-003-0500
www.anbotek.com.cn



1.10. Test Equipment List

Conducted Emission at AC power line						
Item	Equipment	Manufacturer	Model No.	Serial No.	Last Cal.	Cal.Due Date
1	L.I.S.N. Artificial Mains Network	Rohde & Schwarz	ENV216	100055	2023-10-12	2024-10-11
2	Three Phase V-type Artificial Power Network	CYBERTEK	EM5040DT	E215040D T001	2023-07-05	2024-07-04
3	EMI Test Receiver	Rohde & Schwarz	ESCI	100627	2023-10-12	2024-10-11
4	Software Name EZ-EMC	Farad Technology	ANB-03A	N/A	/	/

Occupied Bandwidth Maximum Conducted Output Power Power Spectral Density Emissions in non-restricted frequency bands						
Item	Equipment	Manufacturer	Model No.	Serial No.	Last Cal.	Cal.Due Date
1	Power Meter	Agilent	N1914A	MY500011 02	2023-10-20	2024-10-19
2	DC Power Supply	IVYTECH	IV3605	1804D360 510	2023-10-20	2024-10-19
3	Spectrum Analyzer	Rohde & Schwarz	FSV40-N	101792	2023-05-26	2024-05-25
4	MXA Spectrum Analysis	KEYSIGHT	N9020A	MY505318 23	2023-02-23	2024-02-22
5	Oscilloscope	Tektronix	MDO3012	C020298	2023-10-12	2024-10-11
6	MXG RF Vector Signal Generator	Agilent	N5182A	MY474206 47	2023-02-23	2024-10-22

Band edge emissions (Radiated) Emissions in frequency bands (above 1GHz)						
Item	Equipment	Manufacturer	Model No.	Serial No.	Last Cal.	Cal.Due Date
1	EMI Test Receiver	Rohde & Schwarz	ESR26	101481	2023-10-12	2024-10-11
2	EMI Preamplifier	SKET Electronic	LNPA-0118G-45	SKET-PA-002	2023-10-12	2024-10-11
3	Double Ridged Horn Antenna	SCHWARZBECK	BBHA 9120D	02555	2022-10-16	2025-10-15
4	EMI Test Software EZ-EMC	SHURPLE	N/A	N/A	/	/
5	Horn Antenna	A-INFO	LB-180400-KF	J21106062 8	2023-10-12	2024-10-11
6	Spectrum Analyzer	Rohde & Schwarz	FSV40-N	101792	2023-05-26	2024-05-25
7	Amplifier	Talent Microwave	TLLA18G40 G-50-30	23022802	2023-05-25	2024-05-24

Shenzhen Anbotek Compliance Laboratory Limited

Address: 1/F., Building D, Sogood Science and Technology Park, Sanwei Community, Hangcheng Street, Bao'an District, Shenzhen, Guangdong, China.
Tel: (86)0755-26066440 Fax: (86)0755-26014772 Email: service@anbotek.com



Hotline
400-003-0500
www.anbotek.com.cn



Emissions in frequency bands (below 1GHz)						
Item	Equipment	Manufacturer	Model No.	Serial No.	Last Cal.	Cal.Due Date
1	EMI Test Receiver	Rohde & Schwarz	ESR26	101481	2023-10-12	2024-10-11
2	Pre-amplifier	SONOMA	310N	186860	2023-10-12	2024-10-11
3	Bilog Broadband Antenna	Schwarzbeck	VULB9163	345	2022-10-23	2025-10-22
4	EMI Test Software EZ-EMC	SHURPLE	N/A	N/A	/	/

Shenzhen Anbotek Compliance Laboratory Limited

Address: 1/F., Building D, Sogood Science and Technology Park, Sanwei Community, Hangcheng Street, Bao'an District, Shenzhen, Guangdong, China.
Tel: (86)0755-26066440 Fax: (86)0755-26014772 Email: service@anbotek.com



Hotline
400-003-0500
www.anbotek.com.cn



2. Antenna requirement

Test Requirement:

Refer to 47 CFR Part 15.203, an intentional radiator shall be designed to ensure that no antenna other than that furnished by the responsible party shall be used with the device. The use of a permanently attached antenna or of an antenna that uses a unique coupling to the intentional radiator shall be considered sufficient to comply with the provisions of this section.

2.1. Conclusion

The antenna is a FPC antenna which permanently attached, and the best case gain of the antenna is 3.65 dBi . It complies with the standard requirement.

Shenzhen Anbotek Compliance Laboratory Limited

Address: 1/F., Building D, Sogood Science and Technology Park, Sanwei Community, Hangcheng Street, Bao'an District, Shenzhen, Guangdong, China.
Tel: (86)0755-26066440 Fax: (86)0755-26014772 Email: service@anbotek.com



Hotline
400-003-0500
www.anbotek.com.cn



3. Conducted Emission at AC power line

Test Requirement:	Refer to 47 CFR 15.207(a), Except as shown in paragraphs (b) and (c) of this section, for an intentional radiator that is designed to be connected to the public utility (AC) power line, the radio frequency voltage that is conducted back onto the AC power line on any frequency or frequencies, within the band 150 kHz to 30 MHz, shall not exceed the limits in the following table, as measured using a 50 μ H/50 ohms line impedance stabilization network (LISN).		
Test Limit:	Frequency of emission (MHz)	Conducted limit (dB μ V)	
		Quasi-peak	Average
	0.15-0.5	66 to 56*	56 to 46*
	0.5-5	56	46
	5-30	60	50
	*Decreases with the logarithm of the frequency.		
Test Method:	ANSI C63.10-2020 section 6.2		
Procedure:	Refer to ANSI C63.10-2020 section 6.2, standard test method for ac power-line conducted emissions from unlicensed wireless devices		

3.1. EUT Operation

Operating Environment:	
Test mode:	1: TX mode(BLE 1M): Keep the EUT in continuously transmitting mode (BLE 1M) 2: TX mode(BLE 2M): Keep the EUT in continuously transmitting mode (BLE 2M)

3.2. Test Setup

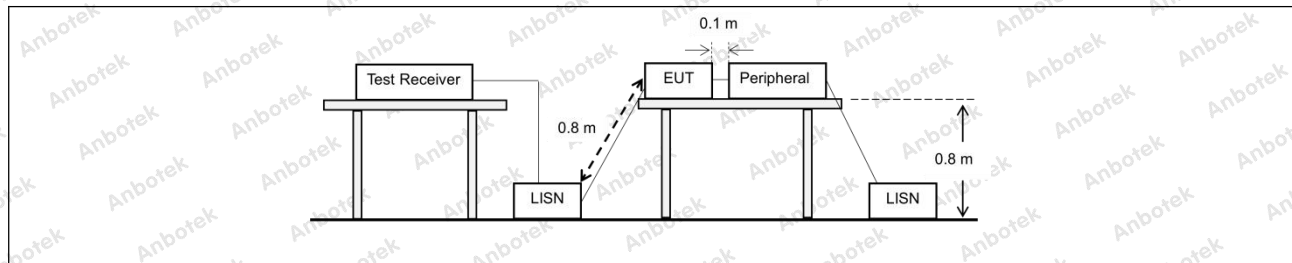

3.3. Test Data

Temperature:	23.4 °C	Humidity:	51 %	Atmospheric Pressure:	101 kPa
--------------	---------	-----------	------	-----------------------	---------

TM2 / Line: Line / Band: 2400-2483.5 MHz /CH: M

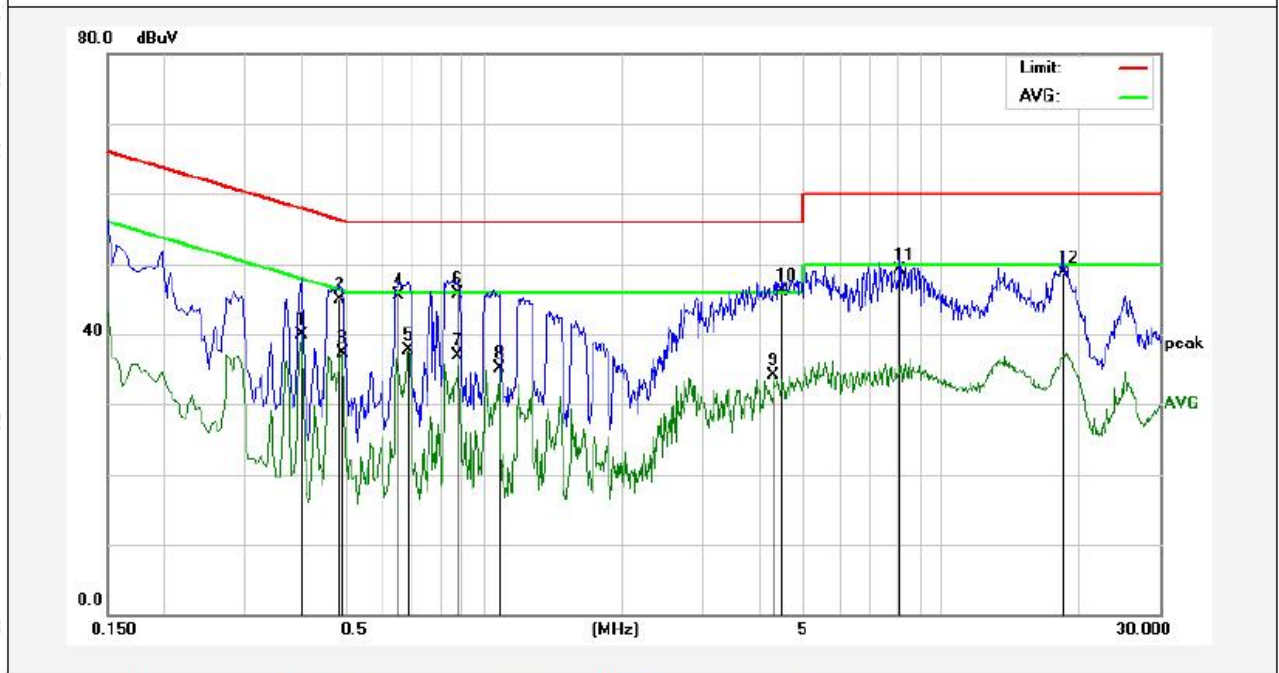

No.	Freq. (MHz)	Reading (dBuV)	Factor (dB)	Result (dBuV)	Limit (dBuV)	Over Limit (dB)	Detector	Remark
1	0.3980	22.66	17.22	39.88	47.89	-8.01	AVG	
2	0.4860	27.45	17.47	44.92	56.24	-11.32	QP	
3	0.4900	19.81	17.49	37.30	46.17	-8.87	AVG	
4	0.6500	27.91	17.60	45.51	56.00	-10.49	QP	
5	0.6860	19.98	17.66	37.64	46.00	-8.36	AVG	
6	0.8780	27.71	18.04	45.75	56.00	-10.25	QP	
7	0.8780	18.90	18.04	36.94	46.00	-9.06	AVG	
8	1.0780	17.27	17.77	35.04	46.00	-10.96	AVG	
9	4.3100	15.51	18.63	34.14	46.00	-11.86	AVG	
10	4.4860	27.49	18.64	46.13	56.00	-9.87	QP	
11	8.1180	29.97	19.04	49.01	60.00	-10.99	QP	
12	18.4980	25.04	23.73	48.77	60.00	-11.23	QP	

Shenzhen Anbotek Compliance Laboratory Limited

Address: 1/F., Building D, Sogood Science and Technology Park, Sanwei Community, Hangcheng Street, Bao'an District, Shenzhen, Guangdong, China.
 Tel: (86)0755-26066440 Fax: (86)0755-26014772 Email: service@anbotek.com



Hotline
 400-003-0500
www.anbotek.com.cn



Temperature:	23.4 °C	Humidity:	51 %	Atmospheric Pressure:	101 kPa
--------------	---------	-----------	------	-----------------------	---------

TM2 / Line: Neutral / Band: 2400-2483.5 MHz /CH: M

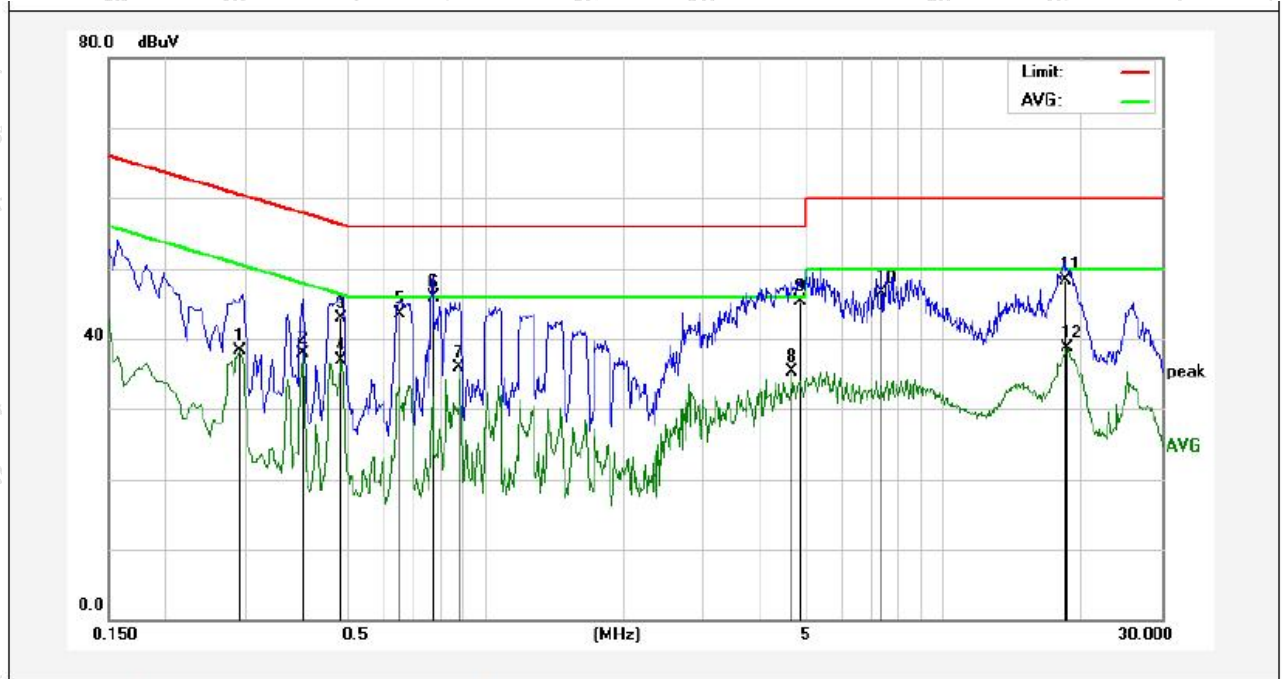

No.	Freq. (MHz)	Reading (dBuV)	Factor (dB)	Result (dBuV)	Limit (dBuV)	Over Limit (dB)	Detector	Remark
1	0.2900	21.21	17.17	38.38	50.52	-12.14	AVG	
2	0.3980	20.66	17.22	37.88	47.89	-10.01	AVG	
3	0.4860	25.45	17.47	42.92	56.24	-13.32	QP	
4	0.4860	19.41	17.47	36.88	46.24	-9.36	AVG	
5	0.6540	25.89	17.61	43.50	56.00	-12.50	QP	
6	0.7700	28.13	17.72	45.85	56.00	-10.15	QP	
7	0.8780	17.78	18.04	35.82	46.00	-10.18	AVG	
8	4.6740	16.59	18.66	35.25	46.00	-10.75	AVG	
9	4.8540	26.62	18.68	45.30	56.00	-10.70	QP	
10	7.3300	27.21	19.27	46.48	60.00	-13.52	QP	
11	18.4300	24.72	23.63	48.35	60.00	-11.65	QP	
12	18.6660	14.76	23.97	38.73	50.00	-11.27	AVG	

Note: Only record the worst data in the report.

Shenzhen Anbotek Compliance Laboratory Limited

Address: 1/F., Building D, Sogood Science and Technology Park, Sanwei Community, Hangcheng Street, Bao'an District, Shenzhen, Guangdong, China.
 Tel: (86)0755-26066440 Fax: (86)0755-26014772 Email: service@anbotek.com

Hotline 400-003-0500
 www.anbotek.com.cn



4. Occupied Bandwidth

Test Requirement:	47 CFR 15.247(a)(2)
Test Limit:	Refer to 47 CFR 15.247(a)(2), Systems using digital modulation techniques may operate in the 902-928 MHz, and 2400-2483.5 MHz bands. The minimum 6 dB bandwidth shall be at least 500 kHz.
Test Method:	ANSI C63.10-2020, section 11.8 KDB 558074 D01 15.247 Meas Guidance v05r02
Procedure:	<p>11.8.1 Option 1</p> <p>The steps for the first option are as follows:</p> <ul style="list-style-type: none"> a) Set RBW = shall be in the range of 1% to 5% of the OBW but not less than 100 kHz. b) Set the VBW $\geq [3 \times \text{RBW}]$. c) Detector = peak. d) Trace mode = max-hold. e) Sweep = No faster than coupled (auto) time. f) Allow the trace to stabilize. g) Measure the maximum width of the emission by placing two markers, one at the lowest frequency and the other at the highest frequency of the envelope of the spectral display, such that each marker is at or slightly below the “-6 dB down amplitude”. If a marker is below this “-6 dB down amplitude” value, then it shall be as close as possible to this value. <p>11.8.2 Option 2</p> <p>The automatic bandwidth measurement capability of an instrument may be employed using the X dB bandwidth mode with X set to 6 dB, if the functionality described in 11.8.1 (i.e., RBW = 100 kHz, VBW $\geq 3 \times \text{RBW}$, and peak detector with maximum hold) is implemented by the instrumentation function.</p> <p>When using this capability, care shall be taken so that the bandwidth measurement is not influenced by any intermediate power nulls in the fundamental emission that might be ≥ 6 dB.</p>

4.1. EUT Operation

Operating Environment:	
Test mode:	<p>1: TX mode(BLE 1M): Keep the EUT in continuously transmitting mode (BLE 1M)</p> <p>2: TX mode(BLE 2M): Keep the EUT in continuously transmitting mode (BLE 2M)</p>

4.2. Test Setup

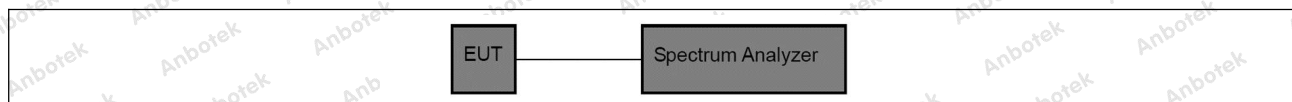

4.3. Test Data

Temperature:	25.1 °C	Humidity:	48.6 %	Atmospheric Pressure:	101 kPa
--------------	---------	-----------	--------	-----------------------	---------

Please Refer to Appendix for Details.

Shenzhen Anbotek Compliance Laboratory Limited

Address: 1/F., Building D, Sogood Science and Technology Park, Sanwei Community, Hangcheng Street, Bao'an District, Shenzhen, Guangdong, China.
Tel: (86)0755-26066440 Fax: (86)0755-26014772 Email: service@anbotek.com

Hotline
400-003-0500
www.anbotek.com.cn



5. Maximum Conducted Output Power

Test Requirement:	47 CFR 15.247(b)(3)
Test Limit:	Refer to 47 CFR 15.247(b)(3), For systems using digital modulation in the 902-928 MHz, 2400-2483.5 MHz, and 5725-5850 MHz bands: 1 Watt. As an alternative to a peak power measurement, compliance with the one Watt limit can be based on a measurement of the maximum conducted output power. Maximum Conducted Output Power is defined as the total transmit power delivered to all antennas and antenna elements averaged across all symbols in the signaling alphabet when the transmitter is operating at its maximum power control level. Power must be summed across all antennas and antenna elements. The average must not include any time intervals during which the transmitter is off or is transmitting at a reduced power level. If multiple modes of operation are possible (e.g., alternative modulation methods), the maximum conducted output power is the highest total transmit power occurring in any mode.
Test Method:	ANSI C63.10-2020 section 11.9.1 KDB 558074 D01 15.247 Meas Guidance v05r02
Procedure:	ANSI C63.10-2020, section 11.9.1 Maximum peak conducted output power

5.1. EUT Operation

Operating Environment:	
Test mode:	1: TX mode(BLE 1M): Keep the EUT in continuously transmitting mode (BLE 1M) 2: TX mode(BLE 2M): Keep the EUT in continuously transmitting mode (BLE 2M)

5.2. Test Setup

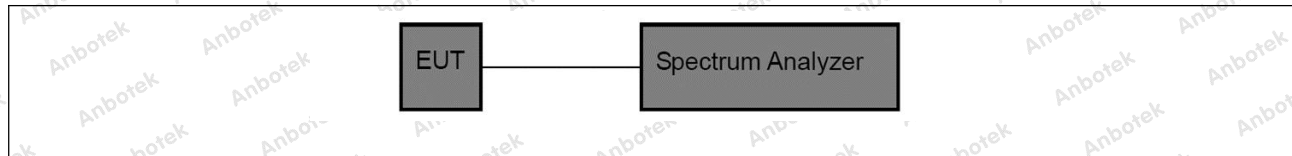

5.3. Test Data

Temperature:	25.1 °C	Humidity:	48.6 %	Atmospheric Pressure:	101 kPa
--------------	---------	-----------	--------	-----------------------	---------

Please Refer to Appendix for Details.



6. Power Spectral Density

Test Requirement:	47 CFR 15.247(e)
Test Limit:	Refer to 47 CFR 15.247(e), For digitally modulated systems, the power spectral density conducted from the intentional radiator to the antenna shall not be greater than 8 dBm in any 3 kHz band during any time interval of continuous transmission. This power spectral density shall be determined in accordance with the provisions of paragraph (b) of this section. The same method of determining the conducted output power shall be used to determine the power spectral density.
Test Method:	ANSI C63.10-2020, section 11.10 KDB 558074 D01 15.247 Meas Guidance v05r02
Procedure:	ANSI C63.10-2020, section 11.10, Maximum power spectral density level in the fundamental emission

6.1. EUT Operation

Operating Environment:	
Test mode:	1: TX mode(BLE 1M): Keep the EUT in continuously transmitting mode (BLE 1M) 2: TX mode(BLE 2M): Keep the EUT in continuously transmitting mode (BLE 2M)

6.2. Test Setup

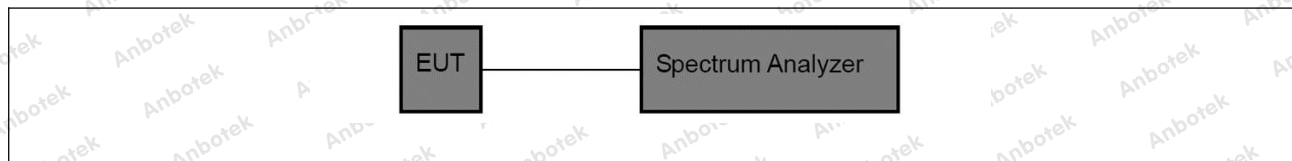

6.3. Test Data

Temperature:	25.1 °C	Humidity:	48.6 %	Atmospheric Pressure:	101 kPa
--------------	---------	-----------	--------	-----------------------	---------

Please Refer to Appendix for Details.



7. Emissions in non-restricted frequency bands

Test Requirement:	47 CFR 15.247(d), 15.209, 15.205
Test Limit:	Refer to 47 CFR 15.247(d), In any 100 kHz bandwidth outside the frequency band in which the spread spectrum or digitally modulated intentional radiator is operating, the radio frequency power that is produced by the intentional radiator shall be at least 20 dB below that in the 100 kHz bandwidth within the band that contains the highest level of the desired power, based on either an RF conducted or a radiated measurement, provided the transmitter demonstrates compliance with the peak conducted power limits. If the transmitter complies with the conducted power limits based on the use of RMS averaging over a time interval, as permitted under paragraph (b)(3) of this section, the attenuation required under this paragraph shall be 30 dB instead of 20 dB. Attenuation below the general limits specified in § 15.209(a) is not required.
Test Method:	ANSI C63.10-2020 section 11.11 KDB 558074 D01 15.247 Meas Guidance v05r02
Procedure:	ANSI C63.10-2020 Section 11.11.1, Section 11.11.2, Section 11.11.3

7.1. EUT Operation

Operating Environment:	
Test mode:	1: TX mode(BLE 1M): Keep the EUT in continuously transmitting mode (BLE 1M) 2: TX mode(BLE 2M): Keep the EUT in continuously transmitting mode (BLE 2M)

7.2. Test Setup

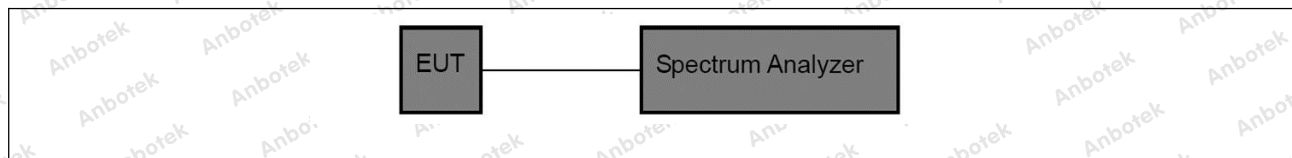

7.3. Test Data

Temperature:	25.1 °C	Humidity:	48.6 %	Atmospheric Pressure:	101 kPa
--------------	---------	-----------	--------	-----------------------	---------

Please Refer to Appendix for Details.



8. Band edge emissions (Radiated)

Test Requirement:	Refer to 47 CFR 15.247(d), In addition, radiated emissions which fall in the restricted bands, as defined in § 15.205(a), must also comply with the radiated emission limits specified in § 15.209(a)(see § 15.205(c)).		
Test Limit:	Frequency (MHz)	Field strength (microvolts/meter)	Measurement distance (meters)
	0.009-0.490	2400/F(kHz)	300
	0.490-1.705	24000/F(kHz)	30
	1.705-30.0	30	30
	30-88	100 **	3
	88-216	150 **	3
	216-960	200 **	3
	Above 960	500	3
	** Except as provided in paragraph (g), fundamental emissions from intentional radiators operating under this section shall not be located in the frequency bands 54-72 MHz, 76-88 MHz, 174-216 MHz or 470-806 MHz. However, operation within these frequency bands is permitted under other sections of this part, e.g., §§ 15.231 and 15.241.		
Test Method:	ANSI C63.10-2020 section 6.10 KDB 558074 D01 15.247 Meas Guidance v05r02		
Procedure:	ANSI C63.10-2020 section 6.10.5.2		

8.1. EUT Operation

Operating Environment:	
Test mode:	1: TX mode(BLE 1M): Keep the EUT in continuously transmitting mode (BLE 1M) 2: TX mode(BLE 2M): Keep the EUT in continuously transmitting mode (BLE 2M)

8.2. Test Setup

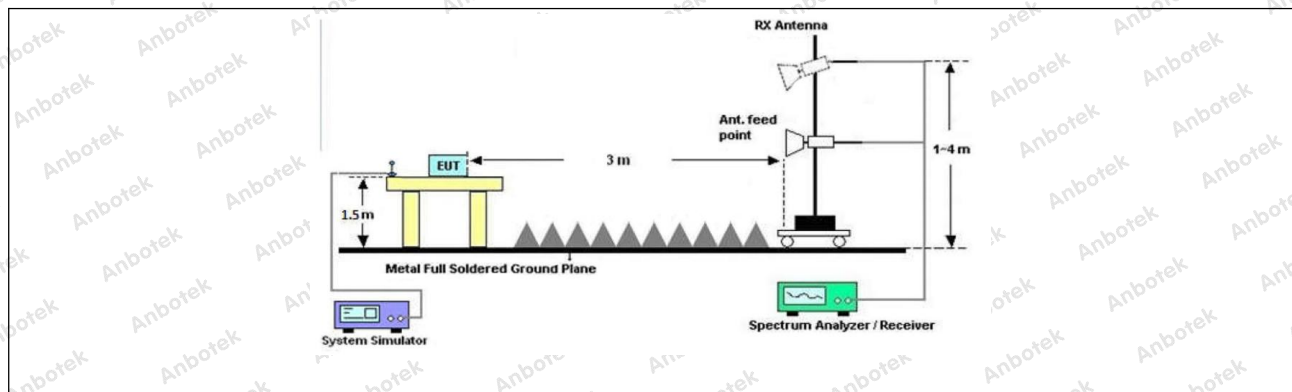

8.3. Test Data

Temperature:	25.1 °C	Humidity:	48.6 %	Atmospheric Pressure:	101 kPa
--------------	---------	-----------	--------	-----------------------	---------

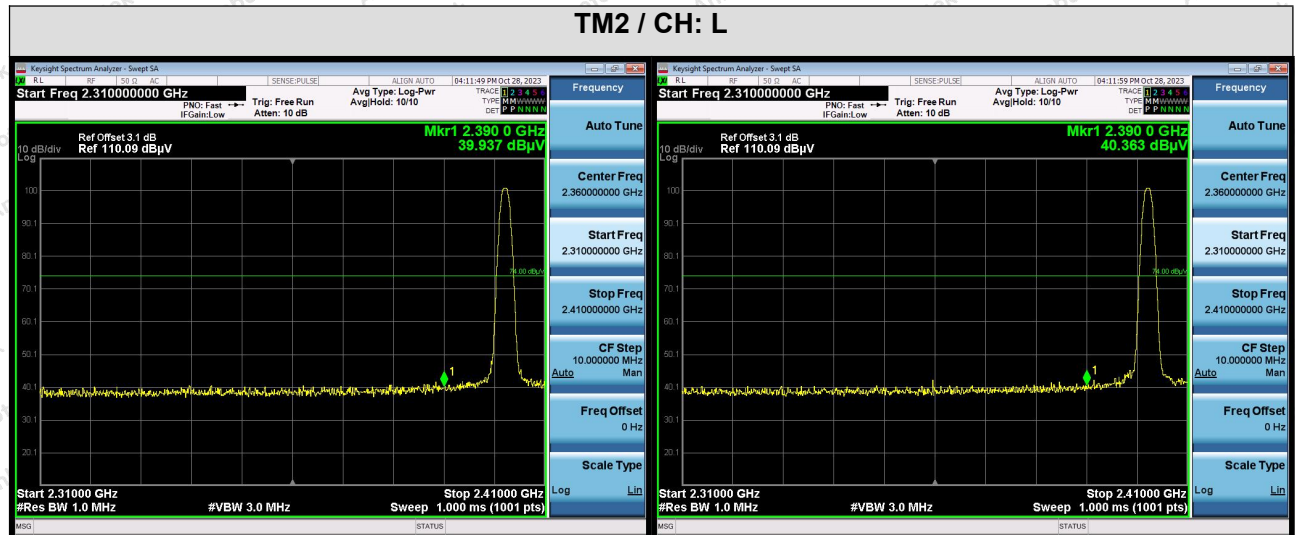

Peak Value(Vertical)

Peak Value(Horizontal)

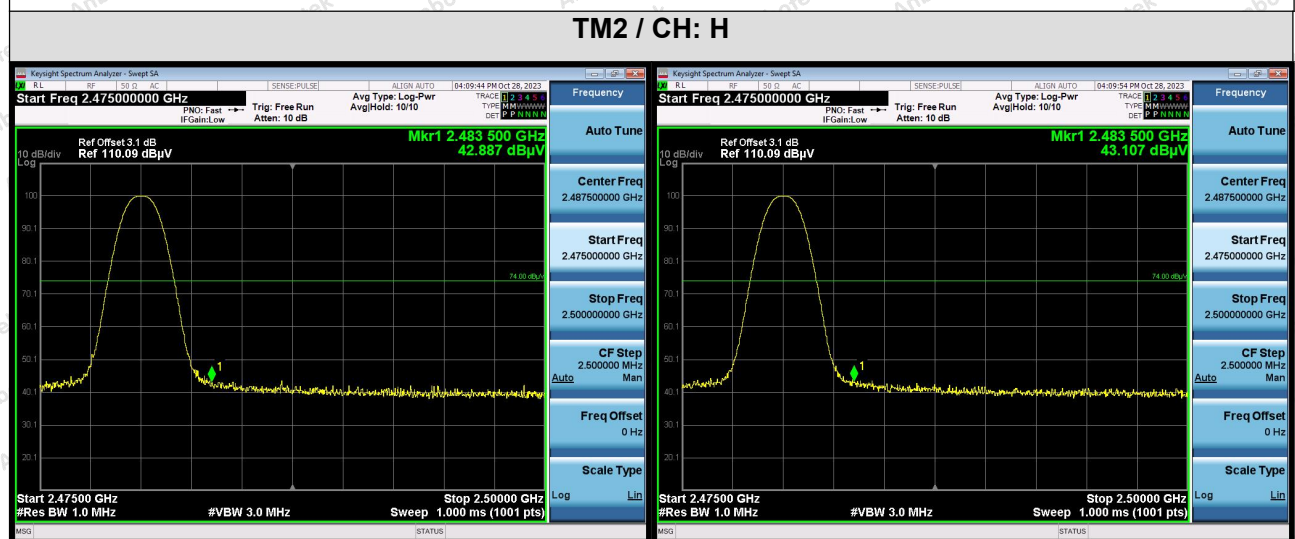

Peak Value(Vertical)

Peak Value(Horizontal)

Shenzhen Anbotek Compliance Laboratory Limited

Address: 1/F., Building D, Sogood Science and Technology Park, Sanwei Community, Hangcheng Street, Bao'an District, Shenzhen, Guangdong, China.
 Tel: (86)0755-26066440 Fax: (86)0755-26014772 Email: service@anbotek.com

Hotline
 400-003-0500
www.anbotek.com.cn



Average:

Test Mode	Peak Value (dBuV/m)	Correction factor	Average Value (dBuV/m)	Limit (dBuV/m)	Polarization	Verdict
TM2 / CH: L	39.937	-4.98	34.960	54.00	Vertical	Pass
	40.363	-4.98	35.386	54.00	Horizontal	Pass
TM2 / CH: H	42.887	-4.93	37.956	54.00	Vertical	Pass
	43.107	-4.93	38.176	54.00	Horizontal	Pass

Remark:

1. During the test, pre-scan all modes, the report only record the worse case mode.
1. Correction factor= $20\log(\text{Duty Cycle})$
2. Average Value=Peak Value+Correction factor



9. Emissions in frequency bands (below 1GHz)

Test Requirement:	Refer to 47 CFR 15.247(d), In addition, radiated emissions which fall in the restricted bands, as defined in § 15.205(a), must also comply with the radiated emission limits specified in § 15.209(a)(see § 15.205(c)).`		
Test Limit:	Frequency (MHz)	Field strength (microvolts/meter)	Measurement distance (meters)
	0.009-0.490	2400/F(kHz)	300
	0.490-1.705	24000/F(kHz)	30
	1.705-30.0	30	30
	30-88	100 **	3
	88-216	150 **	3
	216-960	200 **	3
	Above 960	500	3
** Except as provided in paragraph (g), fundamental emissions from intentional radiators operating under this section shall not be located in the frequency bands 54-72 MHz, 76-88 MHz, 174-216 MHz or 470-806 MHz. However, operation within these frequency bands is permitted under other sections of this part, e.g., §§ 15.231 and 15.241.			
Test Method:	ANSI C63.10-2020 section 6.6.4 KDB 558074 D01 15.247 Meas Guidance v05r02		
Procedure:	ANSI C63.10-2020 section 6.6.4		

9.1. EUT Operation

Operating Environment:	
Test mode:	1: TX mode(BLE 1M): Keep the EUT in continuously transmitting mode (BLE 1M) 2: TX mode(BLE 2M): Keep the EUT in continuously transmitting mode (BLE 2M)



9.2. Test Setup

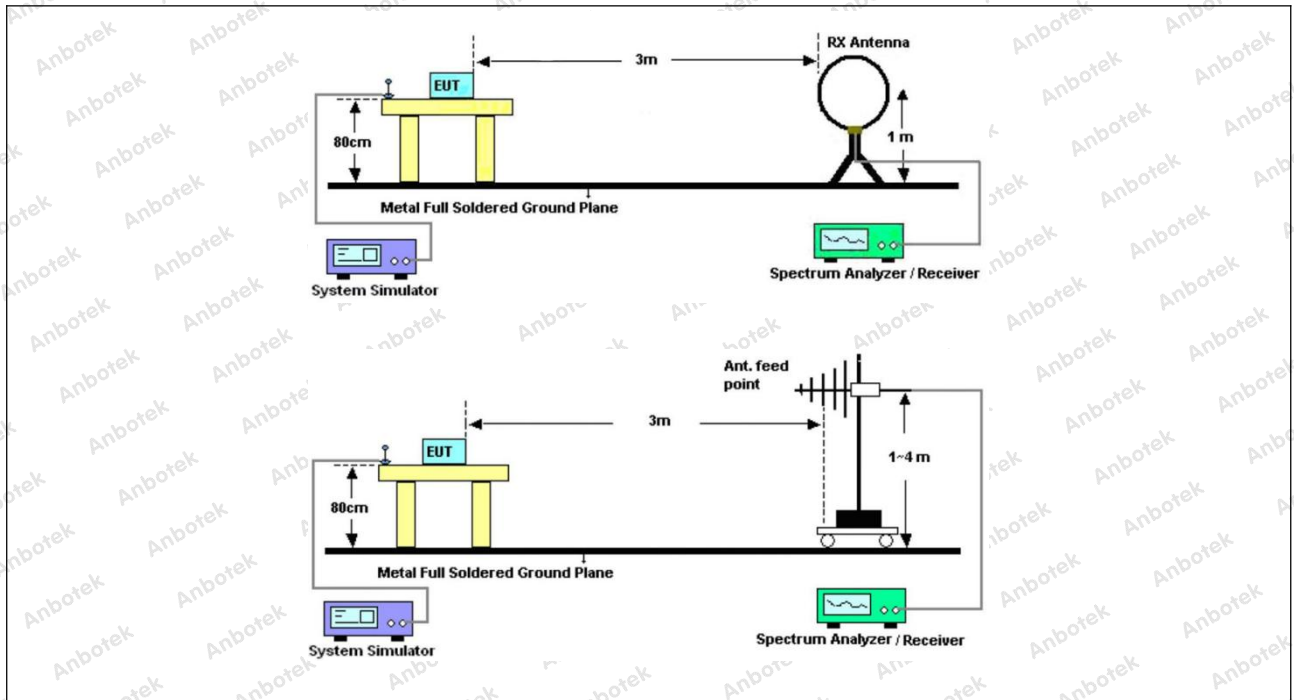

9.3. Test Data

Temperature:	23.5 °C	Humidity:	49 %	Atmospheric Pressure:	101 kPa
--------------	---------	-----------	------	-----------------------	---------

TM2 / Polarization: Horizontal / Band: 2400-2483.5 MHz /CH:M

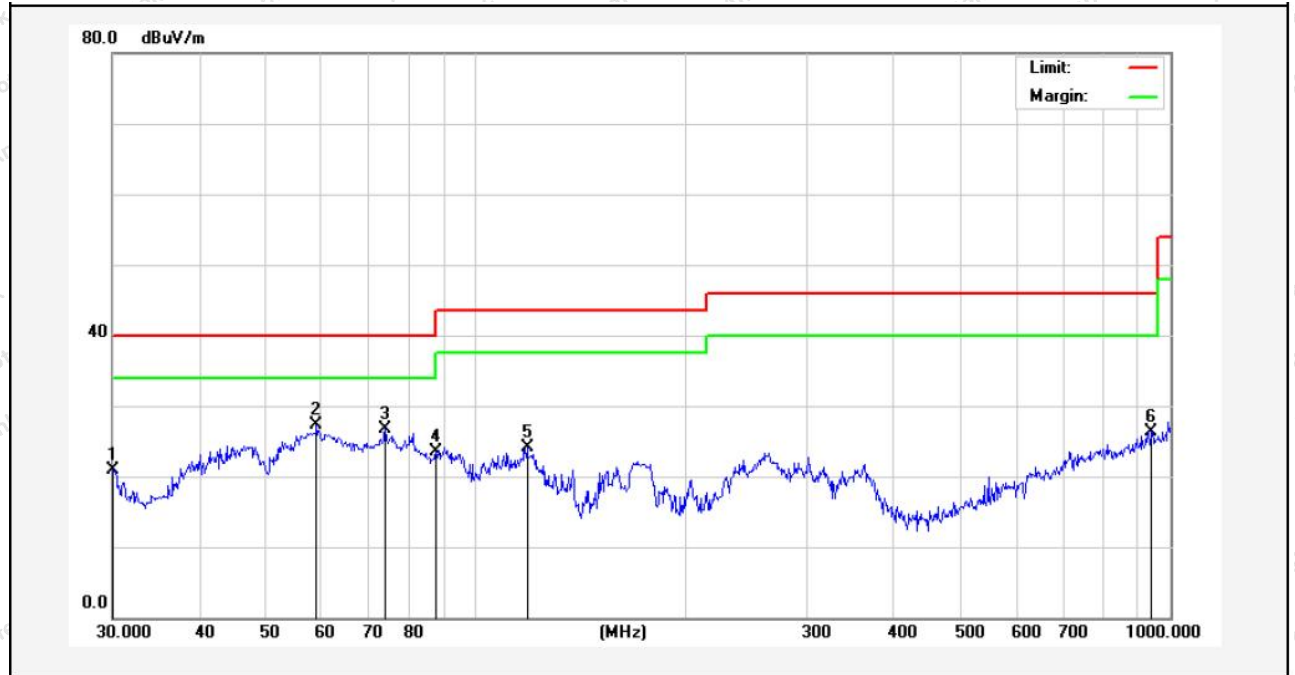

No.	Freq. (MHz)	Reading (dBuV)	Factor (dB/m)	Result (dBuV/m)	Limit (dBuV/m)	Over Limit (dB)	Detector	Height (cm)	degree (deg)	Remark
1	30.0000	41.12	-20.26	20.86	40.00	-19.14	QP			
2	59.0251	44.77	-17.52	27.25	40.00	-12.75	QP			
3	74.1350	48.78	-22.03	26.75	40.00	-13.25	QP			
4	87.7248	45.79	-22.23	23.56	40.00	-16.44	QP			
5	118.6013	47.97	-23.84	24.13	43.50	-19.37	QP			
6	938.8325	32.09	-5.77	26.32	46.00	-19.68	QP			



Temperature:	23.5 °C	Humidity:	49 %	Atmospheric Pressure:	101 kPa
--------------	---------	-----------	------	-----------------------	---------

TM2 / Polarization: Vertical / Band: 2400-2483.5 MHz /CH:M

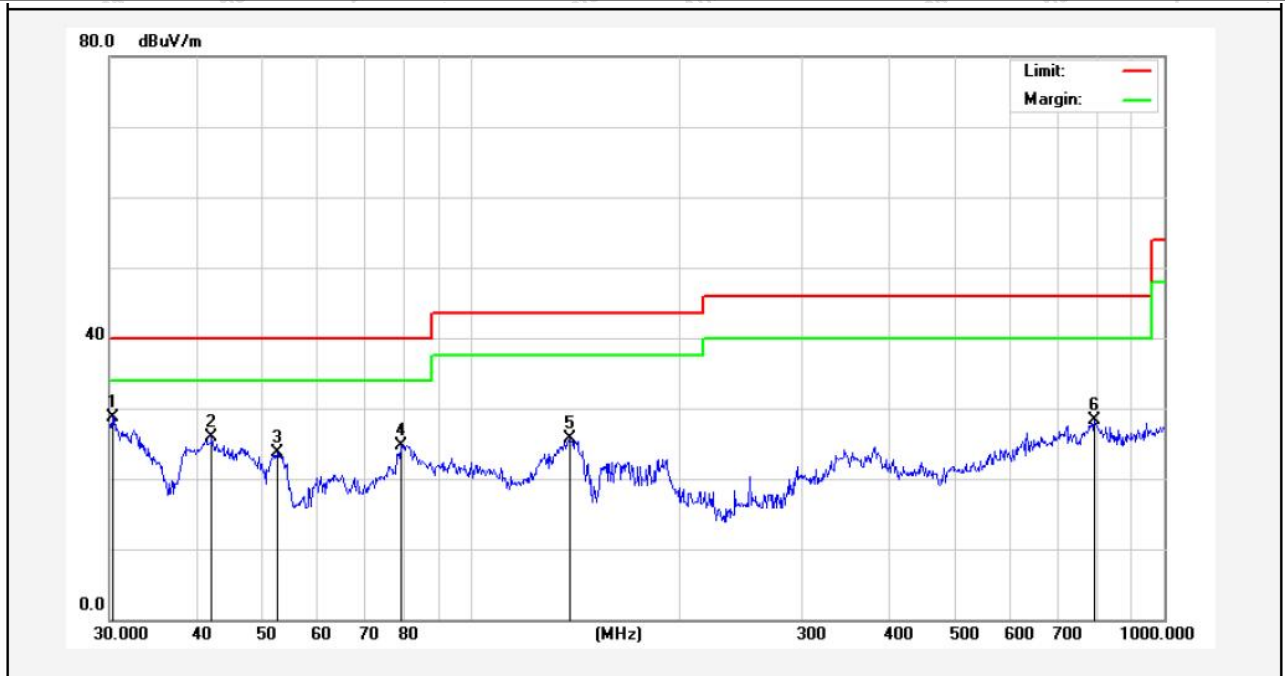

No.	Freq. (MHz)	Reading (dBuV)	Factor (dB/m)	Result (dBuV/m)	Limit (dBuV/m)	Over Limit (dB)	Detector	Height (cm)	degree (deg)	Remark
1	30.3172	46.66	-17.90	28.76	40.00	-11.24	QP			
2	42.1542	40.62	-14.78	25.84	40.00	-14.16	QP			
3	52.3912	40.29	-16.66	23.63	40.00	-16.37	QP			
4	78.9651	44.16	-19.44	24.72	40.00	-15.28	QP			
5	138.3873	47.86	-22.07	25.79	43.50	-17.71	QP			
6	793.3958	36.66	-8.38	28.28	46.00	-17.72	QP			

Note: Only record the worst data in the report.



10. Emissions in frequency bands (above 1GHz)

Test Requirement:	In addition, radiated emissions which fall in the restricted bands, as defined in § 15.205(a), must also comply with the radiated emission limits specified in § 15.209(a)(see § 15.205(c)).		
Test Limit:	Frequency (MHz)	Field strength (microvolts/meter)	Measurement distance (meters)
	0.009-0.490	2400/F(kHz)	300
	0.490-1.705	24000/F(kHz)	30
	1.705-30.0	30	30
	30-88	100 **	3
	88-216	150 **	3
	216-960	200 **	3
	Above 960	500	3
	** Except as provided in paragraph (g), fundamental emissions from intentional radiators operating under this section shall not be located in the frequency bands 54-72 MHz, 76-88 MHz, 174-216 MHz or 470-806 MHz. However, operation within these frequency bands is permitted under other sections of this part, e.g., §§ 15.231 and 15.241.		
Test Method:	ANSI C63.10-2020 section 6.6.4 KDB 558074 D01 15.247 Meas Guidance v05r02		
Procedure:	ANSI C63.10-2020 section 6.6.4		

10.1. EUT Operation

Operating Environment:	
Test mode:	<p>1: TX mode(BLE 1M): Keep the EUT connect to AC power line and works in continuously transmitting mode (BLE 1M)</p> <p>2: TX mode(BLE 2M): Keep the EUT connect to AC power line and works in continuously transmitting mode (BLE 2M)</p>

10.2. Test Setup

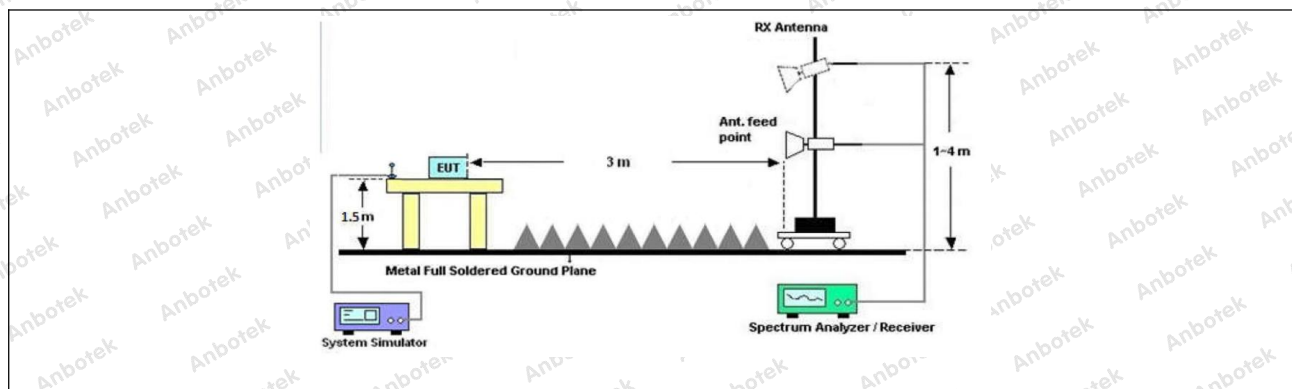

10.3. Test Data

Temperature:	25.1 °C	Humidity:	48.6 %	Atmospheric Pressure:	101 kPa
--------------	---------	-----------	--------	-----------------------	---------

TM2 / CH: L						
Peak value:						
Frequency (MHz)	Reading (dBuV)	Factor (dB/m)	Result (dBuV/m)	Limit Line (dBuV/m)	Over Limit (dB)	polarization
4804.00	27.80	15.27	43.07	74.00	4804.00	Vertical
7206.00	27.97	18.09	46.06	74.00	7206.00	Vertical
9608.00	28.60	23.76	52.36	74.00	9608.00	Vertical
12010.00	*			74.00	12010.00	Vertical
14412.00	*			74.00	14412.00	Vertical
4804.00	27.52	15.27	42.79	74.00	4804.00	Horizontal
7206.00	28.25	18.09	46.34	74.00	7206.00	Horizontal
9608.00	27.83	23.76	51.59	74.00	9608.00	Horizontal
12010.00	*			74.00	12010.00	Horizontal
14412.00	*			74.00	14412.00	Horizontal
Average value:						
Frequency (MHz)	Reading (dBuV)	Factor (dB/m)	Result (dBuV/m)	Limit (dBuV/m)	Over Limit (dB)	polarization
4804.00	16.07	15.27	31.34	54.00	-22.66	Vertical
7206.00	17.02	18.09	35.11	54.00	-18.89	Vertical
9608.00	18.07	23.76	41.83	54.00	-12.17	Vertical
12010.00	*			54.00		Vertical
14412.00	*			54.00		Vertical
4804.00	15.85	15.27	31.12	54.00	-22.88	Horizontal
7206.00	17.28	18.09	35.37	54.00	-18.63	Horizontal
9608.00	17.34	23.76	41.10	54.00	-12.90	Horizontal
12010.00	*			54.00		Horizontal
14412.00	*			54.00		Horizontal

Shenzhen Anbotek Compliance Laboratory Limited

Address: 1/F., Building D, Sogood Science and Technology Park, Sanwei Community, Hangcheng Street, Bao'an District, Shenzhen, Guangdong, China.
 Tel: (86)0755-26066440 Fax: (86)0755-26014772 Email: service@anbotek.com



Hotline
 400-003-0500
www.anbotek.com.cn



TM2 / CH: M						
Peak value:						
Frequency (MHz)	Reading (dBuV)	Factor (dB/m)	Result (dBuV/m)	Limit Line (dBuV/m)	Over Limit (dB)	polarization
4804.00	27.74	15.27	43.01	74.00	-30.99	Vertical
7206.00	27.93	18.09	46.02	74.00	-27.98	Vertical
9608.00	28.53	23.76	52.29	74.00	-21.71	Vertical
12010.00	*			74.00		Vertical
14412.00	*			74.00		Vertical
4804.00	27.47	15.27	42.74	74.00	-31.26	Horizontal
7206.00	28.18	18.09	46.27	74.00	-27.73	Horizontal
9608.00	27.81	23.76	51.57	74.00	-22.43	Horizontal
12010.00	*			74.00		Horizontal
14412.00	*			74.00		Horizontal
Average value:						
Frequency (MHz)	Reading (dBuV)	Factor (dB/m)	Result (dBuV/m)	Limit (dBuV/m)	Over Limit (dB)	polarization
4804.00	16.01	15.27	31.28	54.00	-22.72	Vertical
7206.00	16.98	18.09	35.07	54.00	-18.93	Vertical
9608.00	18.00	23.76	41.76	54.00	-12.24	Vertical
12010.00	*			54.00		Vertical
14412.00	*			54.00		Vertical
4804.00	15.80	15.27	31.07	54.00	-22.93	Horizontal
7206.00	17.21	18.09	35.30	54.00	-18.70	Horizontal
9608.00	17.32	23.76	41.08	54.00	-12.92	Horizontal
12010.00	*			54.00		Horizontal
14412.00	*			54.00		Horizontal

Shenzhen Anbotek Compliance Laboratory Limited

Address: 1/F., Building D, Sogood Science and Technology Park, Sanwei Community, Hangcheng Street, Bao'an District, Shenzhen, Guangdong, China.
 Tel: (86)0755-26066440 Fax: (86)0755-26014772 Email: service@anbotek.com



Hotline
 400-003-0500
www.anbotek.com.cn



TM2 / CH: H						
Peak value:						
Frequency (MHz)	Reading (dBuV)	Factor (dB/m)	Result (dBuV/m)	Limit Line (dBuV/m)	Over Limit (dB)	polarization
4880.00	27.29	15.42	42.71	74.00	-31.29	Vertical
7320.00	27.90	18.02	45.92	74.00	-28.08	Vertical
9760.00	28.03	23.80	51.83	74.00	-22.17	Vertical
12200.00	*			74.00		Vertical
14640.00	*			74.00		Vertical
4880.00	27.28	15.42	42.70	74.00	-31.30	Horizontal
7320.00	28.05	18.02	46.07	74.00	-27.93	Horizontal
9760.00	27.53	23.80	51.33	74.00	-22.67	Horizontal
12200.00	*			74.00		Horizontal
14640.00	*			74.00		Horizontal
Average value:						
Frequency (MHz)	Reading (dBuV)	Factor (dB/m)	Result (dBuV/m)	Limit (dBuV/m)	Over Limit (dB)	polarization
4880.00	16.10	15.42	31.52	54.00	-22.48	Vertical
7320.00	16.84	18.02	34.86	54.00	-19.14	Vertical
9760.00	17.85	23.80	41.65	54.00	-12.35	Vertical
12200.00	*			54.00		Vertical
14640.00	*			54.00		Vertical
4880.00	15.91	15.42	31.33	54.00	-22.67	Horizontal
7320.00	17.56	18.02	35.58	54.00	-18.42	Horizontal
9760.00	17.62	23.80	41.42	54.00	-12.58	Horizontal
12200.00	*			54.00		Horizontal
14640.00	*			54.00		Horizontal

Remark:

1. Result = Reading + Factor
2. “*” means the test results were attenuated more than 20dB below the permissible limits, so the results don't record in the report.
3. Only the worst case is recorded in the report.

Shenzhen Anbotek Compliance Laboratory Limited

Address: 1/F., Building D, Sogood Science and Technology Park, Sanwei Community, Hangcheng Street, Bao'an District, Shenzhen, Guangdong, China.
 Tel: (86)0755-26066440 Fax: (86)0755-26014772 Email: service@anbotek.com



Hotline
 400-003-0500
 www.anbotek.com.cn



APPENDIX I -- TEST SETUP PHOTOGRAPH

Please refer to separated files Appendix I -- Test Setup Photograph_RF

APPENDIX II -- EXTERNAL PHOTOGRAPH

Please refer to separated files Appendix II -- External Photograph

APPENDIX III -- INTERNAL PHOTOGRAPH

Please refer to separated files Appendix III -- Internal Photograph

----- End of Report -----

