

S

T

S

L

A

B



FCC Part 15B TEST REPORT

Report No: STS2101178E01

Issued for

SOURCENEXT CORPORATION

Shiodome City Center 33F, 1-5-2 Higashi Shinbashi
Minato-ku, Tokyo 105-7133, Japan

Product Name:	POCKETALK
Brand Name:	POCKETALK
Model Name:	W1PGK
Series Model:	W1PGG,W1PGW,W1PWG,W1PWK, W1PWW,W1PGR,W1PGP
FCC ID:	2AOJA-W1P
Test Standard:	FCC Part 15B

Any reproduction of this document must be done in full. No single part of this document may be reproduced without permission from STS, All Test Data Presented in this report is only applicable to presented Test sample.

Shenzhen STS Test Services Co., Ltd.
A 1/F, Building B, Zhuoke Science Park, No.190 Chongqing Road, HepingShequ,
Fuyong Sub-District, Bao'an District, Shenzhen, Guang Dong, China
TEL: +86-755 3688 6288 FAX: +86-755 3688 6277 E-mail:sts@ststest.com





TEST RESULT CERTIFICATION

Applicant's Name: SOURCENEXT CORPORATION
Address.....: Shiodome City Center 33F, 1-5-2 Higashi Shinbashi Minato-ku, Tokyo 105-7133, Japan
Manufacture's Name: JENESIS(SHENZHEN)CO.,LTD
Address.....: No.401-1, Building2, Runheng High-Tech Industrial Park, Liuxian 3rd Road No.1, XingDong, Xinan Avenue, Bao'an District, Shenzhen, China

Product Description

Product Name: POCKETALK
Brand Name.....: POCKETALK
Model Name: W1PGK
Series Model W1PGG,W1PGW,W1PWG,W1PWK,W1PWW,W1PGR,W1PGP

Standards.....: FCC Part 15B
Test procedure: ANSI C63.4-2014

This report shall not be reproduced except in full, without the written approval of STS, this document may be altered or revised by STS, personal only, and shall be noted in the revision of the document.

Date of Test.....:
Date of Performance of Tests.: 24 Jan. 2021~04 Feb. 2021
Date of Issue.....: 04 Feb. 2021
Test Result: Pass

Testing Engineer : [Signature]
(Bulun)

Technical Manager : [Signature]
(Barry Li)

Authorized Signatory : [Signature]
(Vita Li)





Table of Contents

1. SUMMARY OF TEST RESULTS	5
1.1 TEST FACTORY	5
1.2 MEASUREMENT UNCERTAINTY	5
2. GENERAL INFORMATION	6
2.1 GENERAL DESCRIPTION OF EUT	6
2.2 DESCRIPTION OF TEST MODES	7
2.3 BLOCK DIGRAM SHOWING THE CONFIGURATION OF SYSTEM TESTED	8
2.4 DESCRIPTION OF SUPPORT UNITS	9
2.5 EQUIPMENTS LIST FOR ALL TEST ITEMS	10
3. EMC EMISSION TEST	11
3.1 CONDUCTED EMISSION MEASUREMENT	11
3.2 RADIATED EMISSION MEASUREMENT	15
APPENDIX 1 - TEST SETUP	21

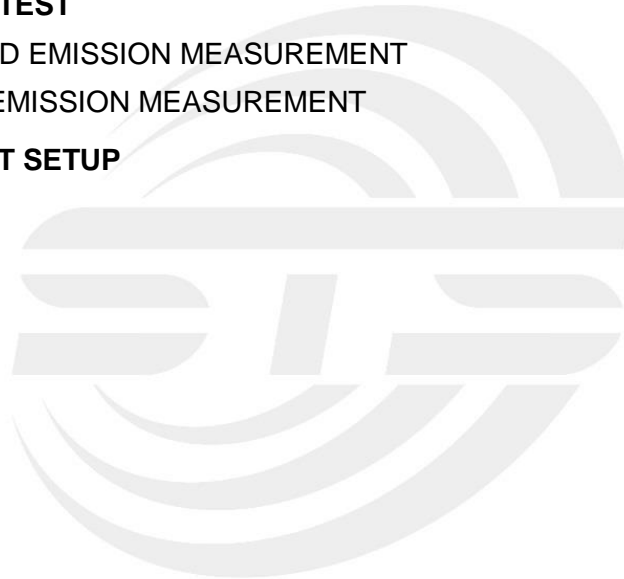



Revision History

Rev.	Issue Date	Report NO.	Effect Page	Contents
00	04 Feb. 2021	STS2101178E01	ALL	Initial Issue





1. SUMMARY OF TEST RESULTS

Test procedures according to the technical standards:

EMISSION			
Standard	Item	Result	Remarks
FCC 47 CFR Part 15 Subpart B	Conducted Emission	PASS	Meet Class B limit
	Radiated Emission	PASS	Meet Class B limit

NOTE:

(1) "N/A" denotes test is not applicable in this Test Report

1.1 TEST FACTORY

Company Name:	SHENZHEN STS TEST SERVICES CO.,LTD.
Address:	A 1/F, Building B, Zhuoke Science Park, No.190 Chongqing Road, HepingShequ, Fuyong Sub-District, Bao'an District, Shenzhen, Guang Dong, China
Telephone:	+86-755 3688 6288
Fax:	+86-755 3688 6277
Registration No.:	FCC Registration No.: 625569
	IC Registration No.: 12108A; A2LA Certificate No.: 4338.01

1.2 MEASUREMENT UNCERTAINTY

The reported uncertainty of measurement $y \pm U$, where expanded uncertainty U is based on a standard uncertainty multiplied by a coverage factor of $k=2$, providing a level of confidence of approximately 95 %.

No.	Item	Uncertainty
1	Conducted Emission (9KHz-150KHz)	± 2.79 dB
2	Conducted Emission (150KHz-30MHz)	± 2.80 dB
3	All emissions,radiated(<1G) 30MHz-1000MHz	± 4.39 dB
4	All emissions,radiated(>1G) 1GHz-6GHz	± 5.10 dB
5	All emissions,radiated(>1G) 6GHz-18GHz	± 5.48 dB
6	All emissions,radiated(18GHz ~ 26 GHz)	± 5.5 dB



2. GENERAL INFORMATION

2.1 GENERAL DESCRIPTION OF EUT

Product Name	POCKETALK	
Brand Name	POCKETALK	
Model Name	W1PGK	
Series Model	W1PGG,W1PGW,W1PWG,W1PWK,W1PWW,W1PGR,W1PGP	
Model Difference	The structure of the circuit is the same, only the name of the model is different	
Frequency Bands	WCDMA	Band II: 1852.4~1907.6MHz Band V: 826.4~846.6MHz
	LTE	Band 2: 1850.7~1909.3MHz
	WLAN	2.4GHz IEEE 802 11b/g/n(HT20):2412~2462MHz 2.4GHz IEEE 802 11n(HT40):2422~2452MHz 5GHz IEEE 802.11a (20MHz): 5180 MHz to 5240 MHz
	Bluetooth	2402~2480MHz
Modulation Mode	WCDMA	QPSK; HSDPA:QPSK/16QAM
	LTE	QPSK,16QAM
	WLAN	2.4GHz: 802.11b(DSSS):CCK,DQPSK,DBPSK 802.11g(OFDM):BPSK,QPSK,16-QAM,64-QAM 802.11n(OFDM):BPSK,QPSK,16-QAM,64-QAM 5GHz: DBPSK/DAPSK/16QAM/64QAM/256QAM
	Bluetooth	BT(1Mbps): GFSK BT EDR(2Mbps): $\pi/4$ -DQPSK BT EDR(3Mbps): 8DPSK
Battery	Rated Voltage: 3.7V Capacity: 2200mAh Charge Limit: 4.2V	
Hardware Version Number	PT2_MB_V1.0	
Software Version Number	3.1.2	

Note: For a more detailed features description, please refer to the manufacturer's specifications or the User's Manual.



2.2 DESCRIPTION OF TEST MODES

To investigate the maximum EMI emission characteristics generates from EUT, the test system was pre-scanning tested base on the consideration of following EUT operation mode or test configuration mode which possible have effect on EMI emission level. Each of these EUT operation mode(s) or test configuration mode(s) mentioned above was evaluated respectively.

Pretest Mode	Description
Mode 1	PC+USB Transmitting+BT Link+WLAN(2.4G)
Mode 2	PC+USB Transmitting+BT Link+WLAN(5G)

For Conducted Test	
Final Test Mode	Description
Mode 1	PC+USB Transmitting+BT Link+WLAN(2.4G)

For Radiated Test	
Final Test Mode	Description
Mode 1	PC+USB Transmitting+BT Link+WLAN(2.4G)

Note:

1. For conducted emission test, test mode 1 was the worst case and only this mode was presented in this report.
2. For radiated emission test, test mode 1 was the worst case and only this mode was presented in this report.
3. We have be tested for all available U.S. voltage and frequencies (For 120V, 50/60Hz) for which the device is capable of operation.

2.3 BLOCK DIGRAM SHOWING THE CONFIGURATION OF SYSTEM TESTED

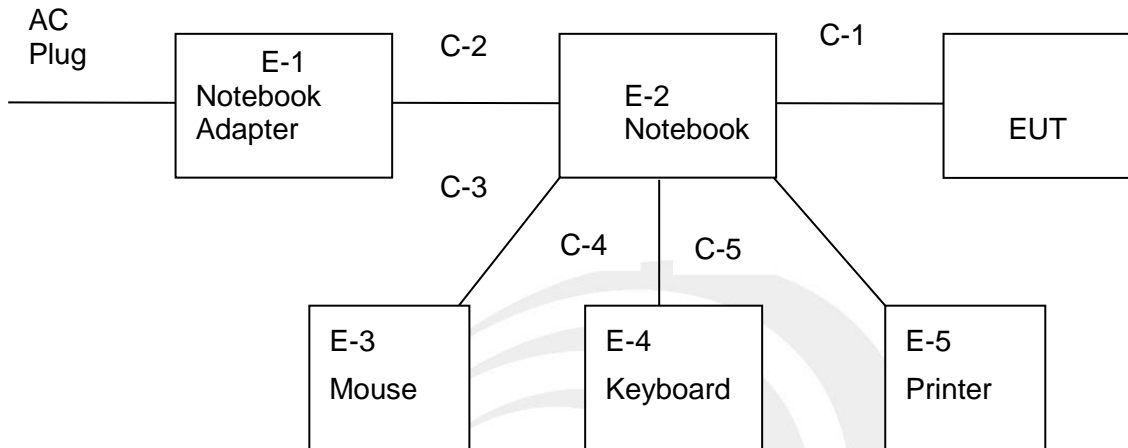



2.4 DESCRIPTION OF SUPPORT UNITS

The EUT has been tested as an independent unit together with other necessary accessories or support units. The following support units or accessories were used to form a representative test configuration during the tests.

Necessary accessories

Item	Equipment	Mfr/Brand	Model/Type No.	Length	Note
N/A	N/A	N/A	N/A	N/A	N/A

Necessary accessories

Item	Equipment	Mfr/Brand	Model/Type No.	Length	Note
E-1	Notebook Adapter	DELL	HSTNN-CA15	N/A	N/A
E-2	Notebook	DELL	500-320cx	N/A	N/A
E-3	Mouse	HP	MODGUO	N/A	N/A
E-4	Keyboard	Acer	SK-9624	N/A	N/A
E-5	Printer	LENOVO	LJ2400L	N/A	N/A
C-1	USB Cable	N/A	N/A	110cm	NO
C-2	DC Cable	N/A	N/A	110cm	NO
C-3	USB Cable	N/A	N/A	180cm	NO
C-4	USB Cable	N/A	N/A	180cm	NO
C-5	USB Cable	N/A	N/A	180cm	NO

Note:

- (1) For detachable type I/O cable should be specified the length in cm in 『Length』 column.
- (2) “YES” is means “shielded” “with core”; “NO” is means “unshielded” “without core”.



2.5 EQUIPMENTS LIST FOR ALL TEST ITEMS

The EUT has been tested as an independent unit together with other necessary accessories or support units. The following support units or accessories were used to form a representative test configuration during the tests.

Radiation Test equipment

Kind of Equipment	Manufacturer	Type No.	Serial No.	Last Calibration	Calibrated Until
EMI Test Receiver	R&S	ESCI	101427	2020.10.12	2021.10.11
Bi-log Antenna	TESEQ	CBL6111D	34678	2020.10.12	2022.10.11
Horn Antenna	SCHWARZBECK	BBHA 9120D	1343	2020.10.12	2022.10.11
Pre-amplifier(1-26.5G)	Agilent	8449B	3008A02383	2020.10.12	2021.10.11
Pre-amplifier(0.1M-3GHz)	EM	EM330	060665	2020.10.12	2021.10.11
Spectrum Analyzer	Agilent	N9020A	MY49100060	2020.10.12	2021.10.11
RE Cable (9K-1G)	N/A	R01	N/A	2020.10.12	2021.10.11
RE Cable (1-26G)	N/A	R02	N/A	2020.10.12	2021.10.11
Temperature & Humidity	Mieo	HH660	N/A	2020.10.13	2021.10.12
Horn Antenna(18-40G)	A-INFO	LB-180400-K F	J211020657	2020.10.12	2022.10.11
Testing Software	EZ-EMC(Ver.STSLAB-03A1 RE)				

Conduction Test equipment

Kind of Equipment	Manufacturer	Type No.	Serial No.	Last Calibration	Calibrated Until
EMI Test Receiver	R&S	ESCI	101427	2020.10.12	2021.10.11
LISN	R&S	ENV216	101242	2020.10.12	2021.10.11
LISN	ETS	3810/2NM	00023625	2020.10.12	2021.10.11
Absorbing Clamp	R&S	MDS-21	100668	2020.10.13	2021.10.12
CE Cable	N/A	C01	N/A	2020.10.13	2021.10.12
Temperature & Humidity	Mieo	HH660	N/A	2020.10.13	2021.10.12
Testing Software	EZ-EMC(Ver.STSLAB-03A1 CE)				



3. EMC EMISSION TEST

3.1 CONDUCTED EMISSION MEASUREMENT

3.1.1 POWER LINE CONDUCTED EMISSION Limits

FREQUENCY (MHz)	Conducted Emission Limits (dBuV)			
	<input type="checkbox"/> Class A (dB μ V)		<input checked="" type="checkbox"/> Class B (dB μ V)	
	Quasi-peak	Average	Quasi-peak	Average
0.15 -0.5	79.00	66.00	66 - 56 *	56 - 46 *
0.50 -5.0	73.00	60.00	56.00	46.00
5.0 -30.0	73.00	60.00	60.00	50.00

Note:

- (1) The tighter limit applies at the band edges.
- (2) The limit of " * " marked band means the limitation decreases linearly with the logarithm of the frequency in the range.

The following table is the setting of the receiver

Receiver Parameters	Setting
Attenuation	10 dB
Start Frequency	0.15 MHz
Stop Frequency	30 MHz
IF Bandwidth	9 kHz

3.1.2 TEST PROCEDURE

- a. The EUT was 0.8 meters from the horizontal ground plane and 0.4 meters from the vertical ground plane with EUT being connected to the power mains through a line impedance stabilization network (LISN). All other support equipments powered from additional LISN(s). The LISN provide 50 Ohm/ 50uH of coupling impedance for the measuring instrument.
- b. Interconnecting cables that hang closer than 40 cm to the ground plane shall be folded back and forth in the center forming a bundle 30 to 40 cm long.
- c. I/O cables that are not connected to a peripheral shall be bundled in the center. The end of the cable may be terminated, if required, using the correct terminating impedance. The overall length shall not exceed 1 m.
- d. LISN at least 80 cm from nearest part of EUT chassis.
- e. For the actual test configuration, please refer to the related Item –EUT Test Photos.

3.1.3 DEVIATION FROM TEST STANDARD

No deviation

3.1.4 TEST SETUP

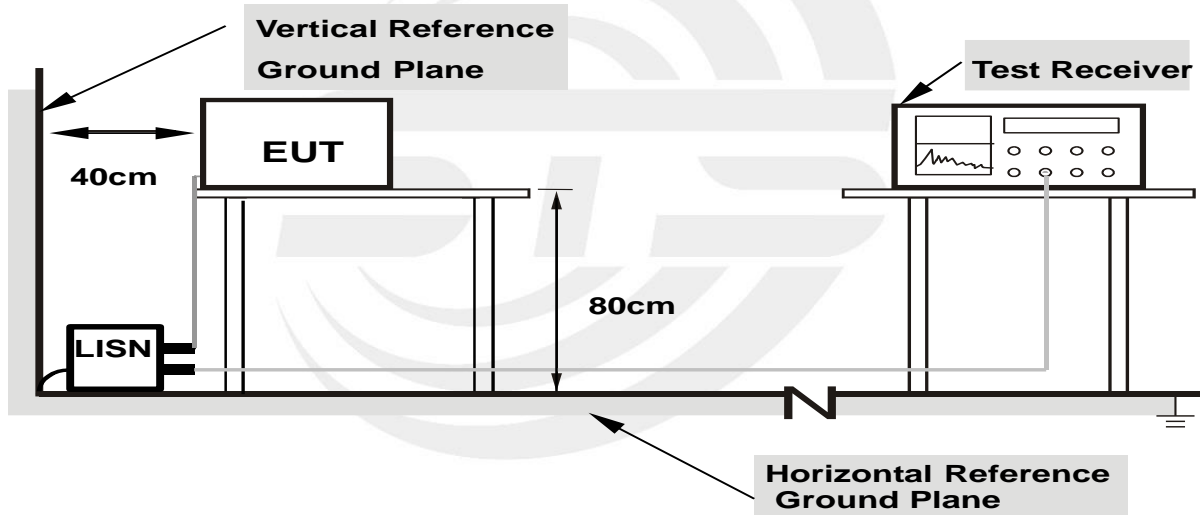

- Note: 1.Support units were connected to second LISN.**
2.Both of LISNs (AMN) are 80 cm from EUT and at least 80 from other units and other metal planes

3.1.5 EUT OPERATING CONDITIONS

The EUT was configured for testing in a typical fashion (as a customer would normally use it). The EUT has been programmed to continuously transmit during test. This operating condition was tested and used to collect the included data.



3.1.6 TEST RESULTS

Temperature:	22 °C	Relative Humidity:	36%
Phase:	L	Test Mode:	Mode 1
Test Voltage:	AC 120V/60Hz		

No.	Frequency (MHz)	Reading (dBuV)	Correct Factor (dB)	Result (dBuV)	Limit (dBuV)	Margin (dB)	Detector
1	0.1500	40.55	20.29	60.84	66.00	-5.16	QP
2	0.1500	13.46	20.29	33.75	56.00	-22.25	AVG
3	0.5900	13.91	20.44	34.35	56.00	-21.65	QP
4	0.5900	3.21	20.44	23.65	46.00	-22.35	AVG
5	1.5860	18.54	20.35	38.89	56.00	-17.11	QP
6	1.5860	9.88	20.35	30.23	46.00	-15.77	AVG
7	2.1100	19.20	20.39	39.59	56.00	-16.41	QP
8	2.1100	8.08	20.39	28.47	46.00	-17.53	AVG
9	4.9540	11.04	20.53	31.57	56.00	-24.43	QP
10	4.9540	-0.89	20.53	19.64	46.00	-26.36	AVG
11	23.6700	9.21	22.77	31.98	60.00	-28.02	QP
12	23.6700	-2.88	22.77	19.89	50.00	-30.11	AVG

Remark:

1. All readings are Quasi-Peak and Average values.
2. Margin = Result (Result = Reading + Factor) – Limit
3. Factor = Cable Loss + Antenna Factor - Amplifier Gain

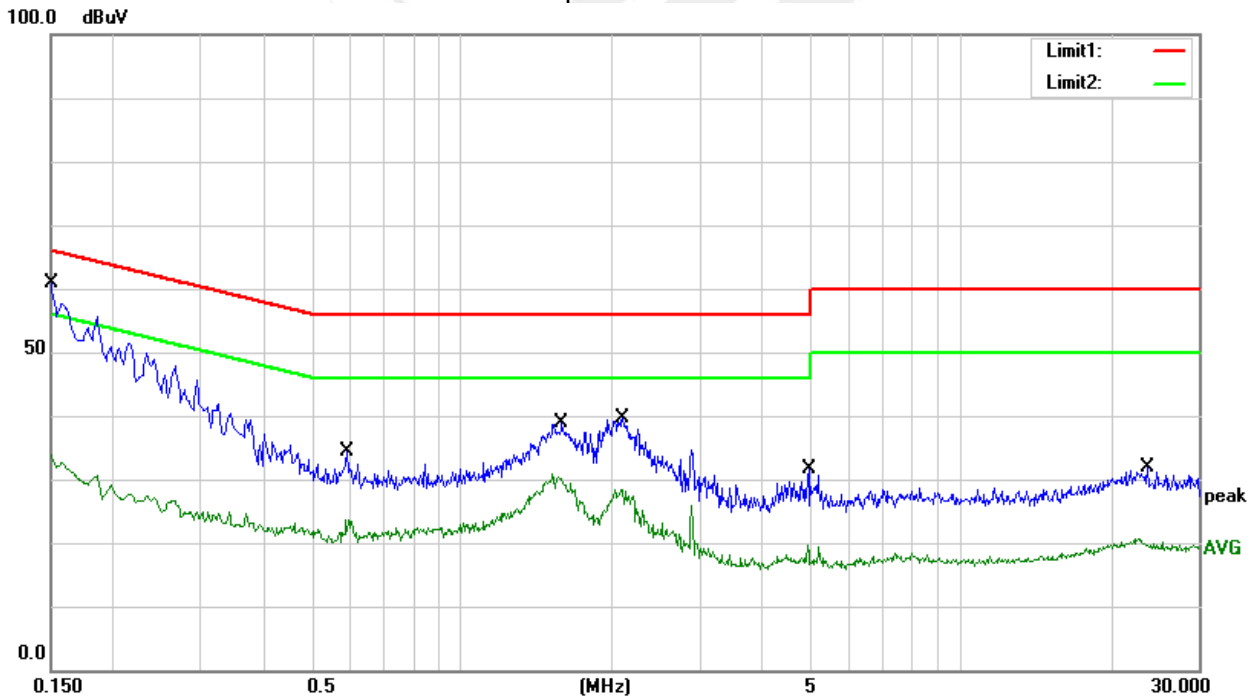



Temperature:	22 °C	Relative Humidity:	36%
Phase:	N	Test Mode:	Mode 1
Test Voltage:	AC 120V/60Hz		

No.	Frequency (MHz)	Reading (dBuV)	Correct Factor (dB)	Result (dBuV)	Limit (dBuV)	Margin (dB)	Detector
1	0.1580	33.06	20.31	53.37	65.57	-12.20	QP
2	0.1580	12.81	20.31	33.12	55.57	-22.45	AVG
3	0.5820	15.09	20.44	35.53	56.00	-20.47	QP
4	0.5820	1.10	20.44	21.54	46.00	-24.46	AVG
5	1.5980	18.57	20.35	38.92	56.00	-17.08	QP
6	1.5980	11.06	20.35	31.41	46.00	-14.59	AVG
7	1.9980	20.01	20.39	40.40	56.00	-15.60	QP
8	1.9980	10.11	20.39	30.50	46.00	-15.50	AVG
9	4.7300	10.08	20.53	30.61	56.00	-25.39	QP
10	4.7300	-0.39	20.53	20.14	46.00	-25.86	AVG
11	22.1820	8.08	22.82	30.90	60.00	-29.10	QP
12	22.1820	-1.59	22.82	21.23	50.00	-28.77	AVG

Remark:

1. All readings are Quasi-Peak and Average values.
2. Margin = Result (Result = Reading + Factor) - Limit
3. Factor = Cable Loss + Antenna Factor - Amplifier Gain

100.0 dBuV

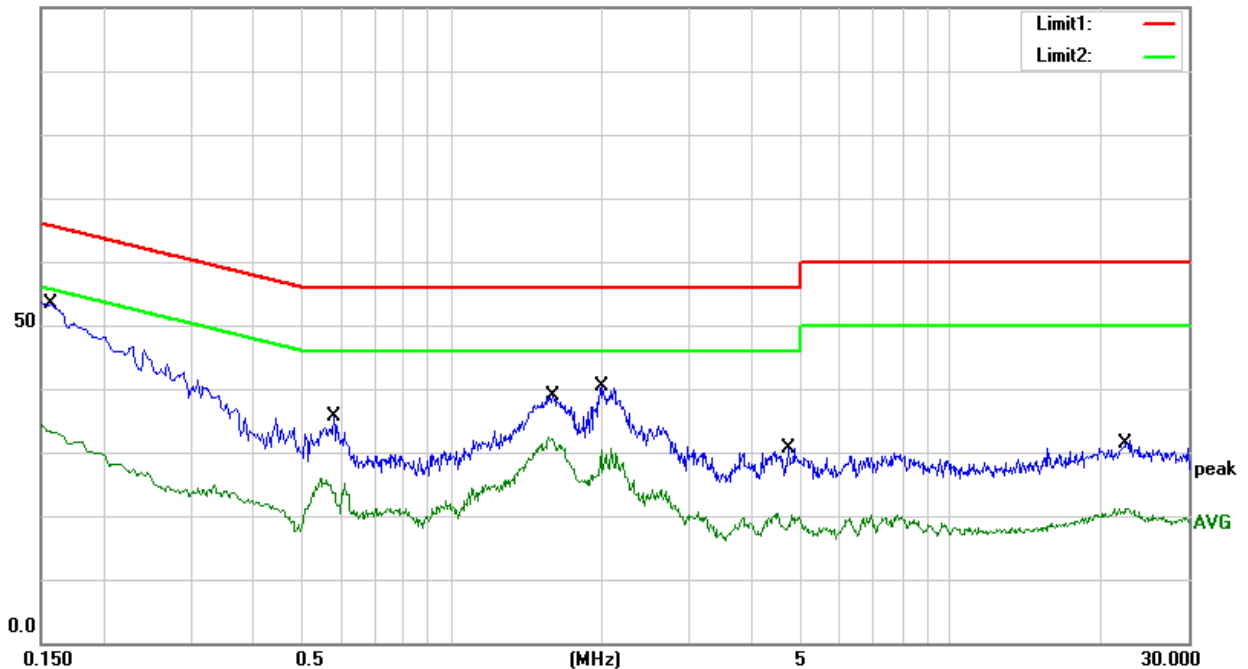



3.2 RADIATED EMISSION MEASUREMENT

3.2.1 Radiated Emission Limits

Below 1 GHz

Measurement Method and Applied Limits:

ANSI C63.4:

Frequency (MHz)	<input type="checkbox"/> Class A		<input checked="" type="checkbox"/> Class B
	Field strength (dBuV/m) (at 10m)	Field strength (dBuV/m) (at 3m)	Field strength (dBuV/m) (at 3m)
30 ~ 88	39	49	40
88 ~ 216	43.5	53.5	43.5
216 ~ 960	46	56	46
Above 960	49.5	59.5	54

Above 1 GHz

Measurement Method and Applied Limits:

ANSI C63.4:

Frequency (MHz)	<input type="checkbox"/> Class A				<input type="checkbox"/> Class B	
	(dBuV/m) (at 3m)		(dBuV/m) (at 10m)		(dBuV/m) (at 3m)	
	Peak	Average	Peak	Average	Peak	Average
Above 1000	80	60	69.5	49.5	74	54

Frequency Range of Radiated Disturbance Measurement

Highest frequency generated or Upper frequency of measurement used in the device or on which the device operates or tunes (MHz)	Range (MHz)
Below 1.705	30
1.705 ~ 108	1000
108 ~ 500	2000
500 ~ 1000	5000
Above 1000	5th harmonic of the highest frequency or 40 GHz, whichever is lower

Note:

- (1) The limit for radiated test was performed in the following: FCC PART 15B.
- (2) The tighter limit applies at the band edges.
- (3) Emission level (dBuV/m) = 20log Emission level (uV/m).



3.2.2 TEST PROCEDURE

- a. The EUT was placed on the top of a rotating table 0.8 meter above the ground at a 3 meter semi-anechoic chamber room. The table was rotated 360 degrees to determine the position of the highest radiation.
- b. EUT as the center to the edge of the auxiliary device, the distance from the maximum edge to the center of the antenna is 3 meter.
- c. The height of antenna is varied from 1 meter to 4 meter above the ground to determine the maximum value of the field strength. Both horizontal and vertical polarizations of the antenna are set to make the measurement.
- d. For each suspected emission, the EUT was arranged to its worst case and then the antenna was tuned to heights from 1 meter to 4 meter and the rotatable table was turned from 0 degrees to 360 degree to find the maximum reading.
- e. The test-receiver system was set to quasi-peak detect function and specified bandwidth with maximum hold mode when the test frequency is below 1GHz.
- f. For the actual test configuration, please refer to the related Item –EUT Test Photos.

Note: Both horizontal and vertical antenna polarities were tested and performed pretest to three orthogonal axis. The worst case emissions were reported

3.2.3 DEVIATION FROM TEST STANDARD

No deviation

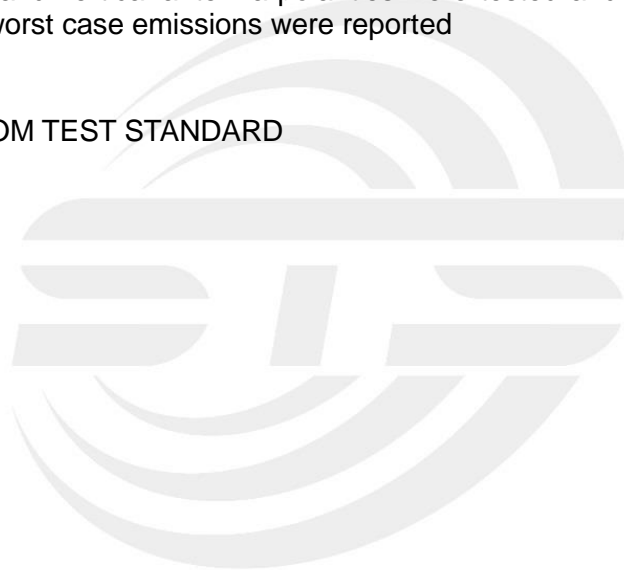

3.2.4 TEST SETUP

(A) Radiated Emission Test-Up Frequency 30MHz~1GHz

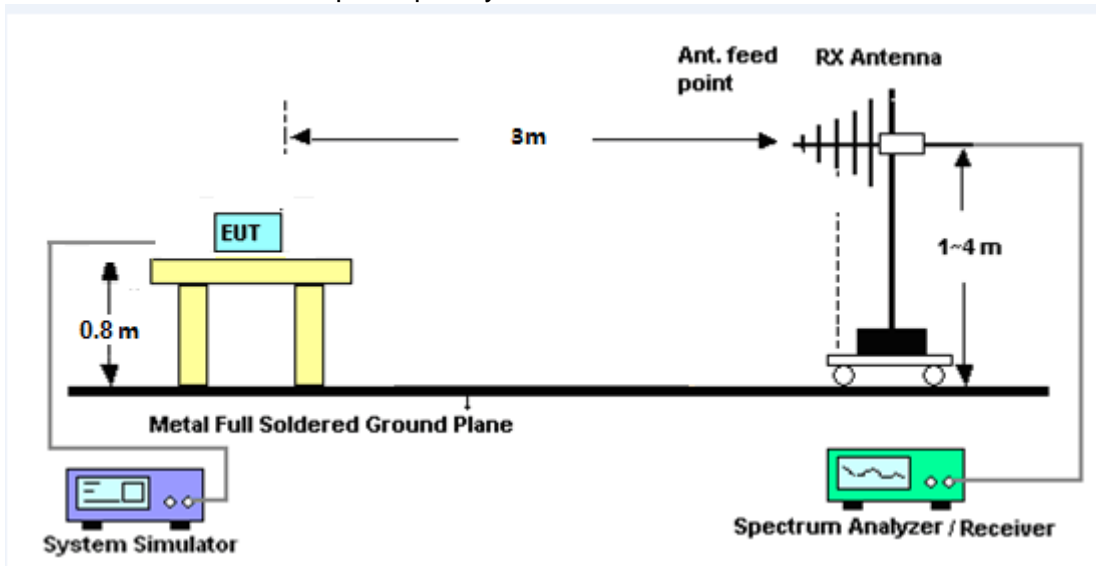

(B) Radiated Emission Test-Up Frequency Above 1GHz

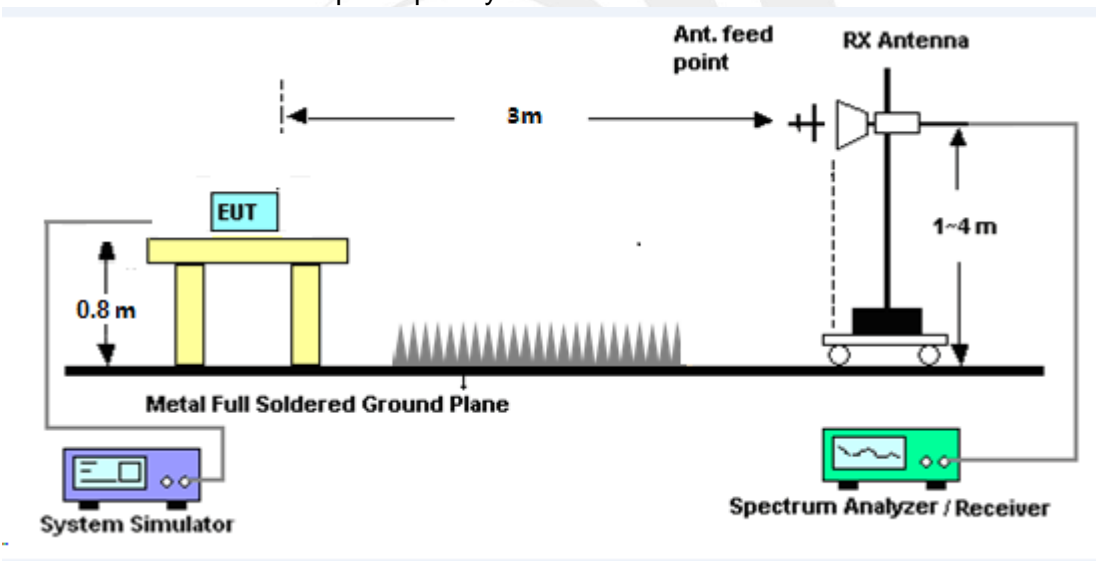

3.2.5 EUT OPERATING CONDITIONS

The EUT tested system was configured as the statements of 2.4 Unless otherwise a special operating condition is specified in the follows during the testing.



3.2.6 TEST RESULTS

30MHz -1000MHz

Temperature:	23 °C	Relative Humidity:	46%
Phase:	Horizontal	Test Mode:	Mode 1
Test Voltage:	AC 120V/60Hz		

No.	Frequency (MHz)	Reading (dBuV)	Correct Factor (dB)	Results (dBuV/m)	Limit (dBuV/m)	Margin (dB)	Detector
1	141.3298	45.17	-18.64	26.53	43.50	-16.97	QP
2	172.5988	55.07	-20.13	34.94	43.50	-8.56	QP
3	239.9873	51.68	-19.26	32.42	46.00	-13.58	QP
4	351.7080	46.94	-14.84	32.10	46.00	-13.90	QP
5	601.4265	42.70	-8.57	34.13	46.00	-11.87	QP
6	1000.0000	36.10	-2.19	33.91	54.00	-20.09	QP

Remark:

1. Margin = Result (Result =Reading + Factor)–Limit
2. Factor= Cable Loss +Antenna Factor-Amplifier Gain

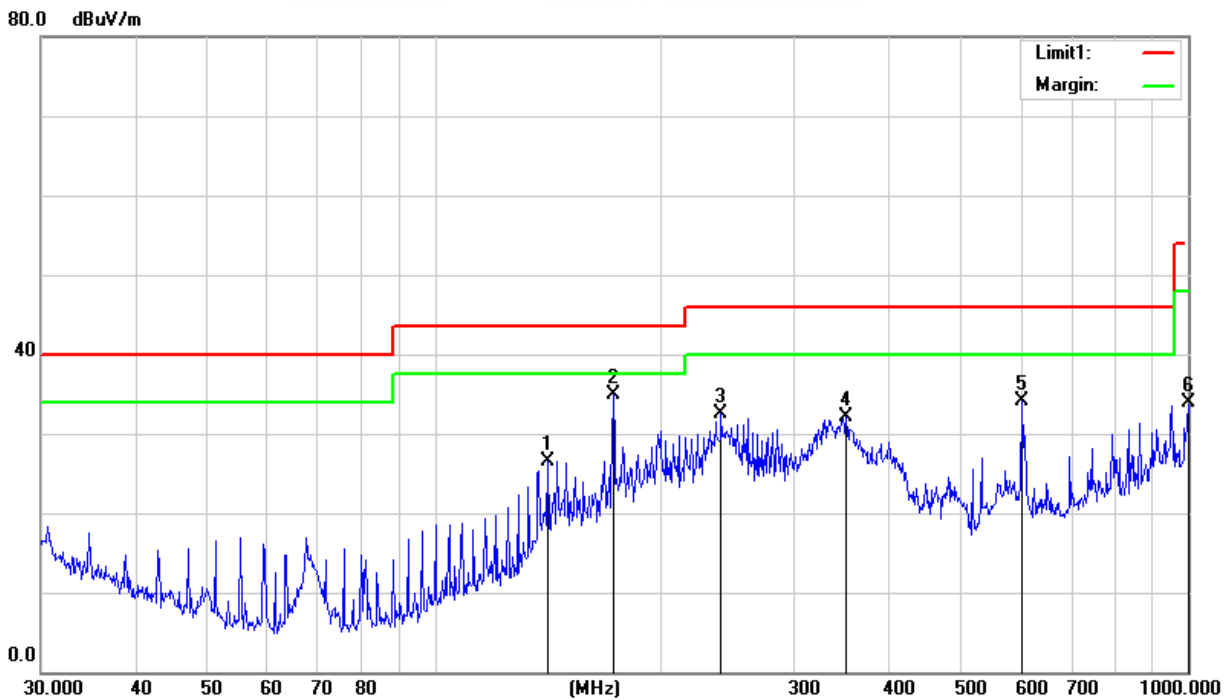



Temperature:	23 °C	Relative Humidity:	46%
Phase:	Vertical	Test Mode:	Mode 1
Test Voltage:	AC 120V/60Hz		

No.	Frequency (MHz)	Reading (dBuV)	Correct Factor (dB)	Results (dBuV/m)	Limit (dBuV/m)	Margin (dB)	Detector
1	30.6380	46.50	-11.39	35.11	40.00	-4.89	QP
2	46.9948	53.45	-20.14	33.31	40.00	-6.69	QP
3	67.4382	52.80	-26.01	26.79	40.00	-13.21	QP
4	172.5988	54.24	-20.13	34.11	43.50	-9.39	QP
5	322.1886	42.87	-14.84	28.03	46.00	-17.97	QP
6	607.7867	41.67	-8.65	33.02	46.00	-12.98	QP

Remark:

1. Margin = Result (Result = Reading + Factor) - Limit
2. Factor = Cable Loss + Antenna Factor - Amplifier Gain

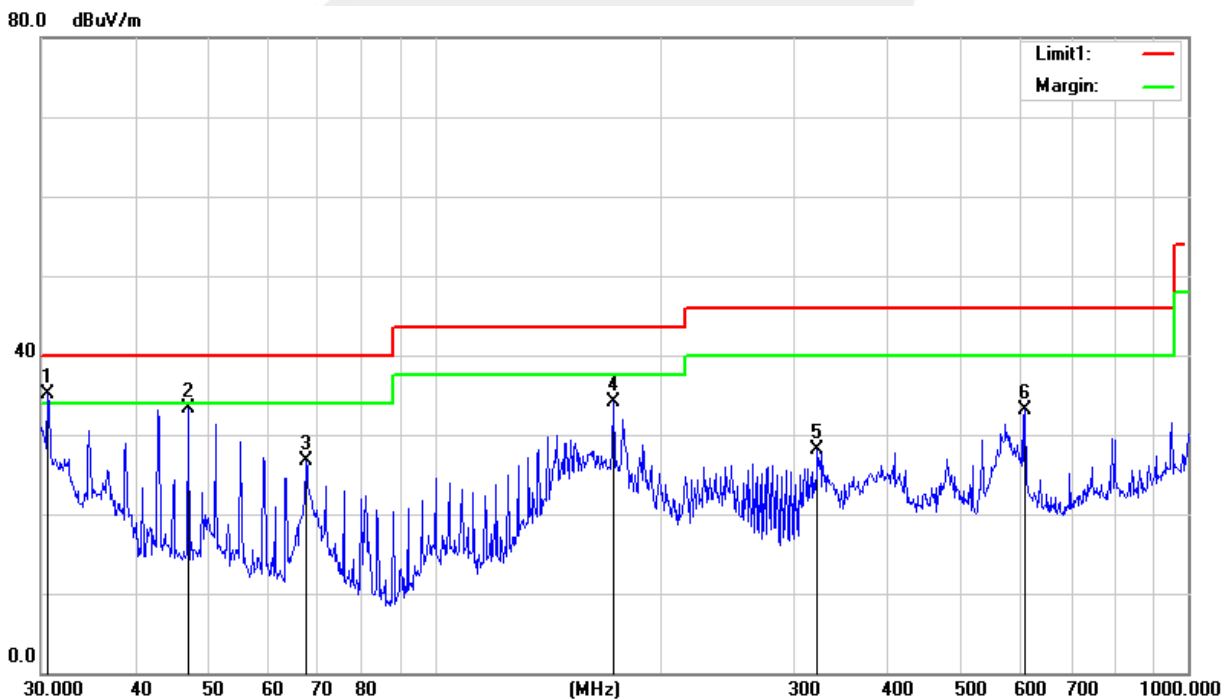



SAMPLE OF THE LABEL



Trade Name

Model Number

This device complies with part 15 of the FCC Rules. Operation is subject to the following two conditions:
(1) This device may not cause harmful interference. And (2) this device must accept any interference received, including interference that may cause undesired operation.



APPENDIX 1 - TEST SETUP

RE (Below 1GHz)

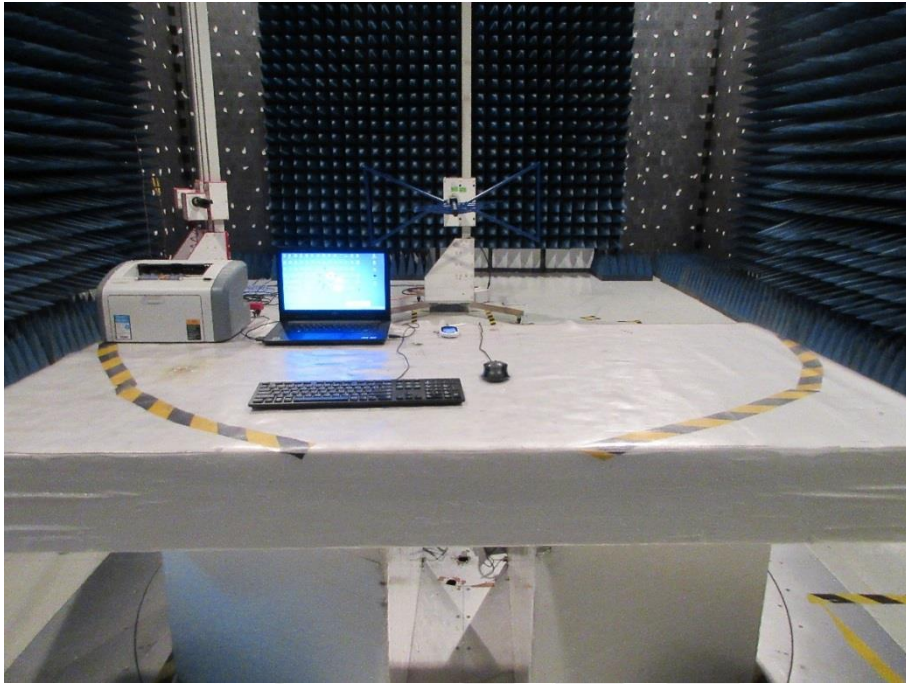

CE



※※※※END OF THE REPORT※※※※