

T29UTW-7-WIFI(TY)

OPERATING
INSTRUCTION

OPERATING
INSTRUCTION

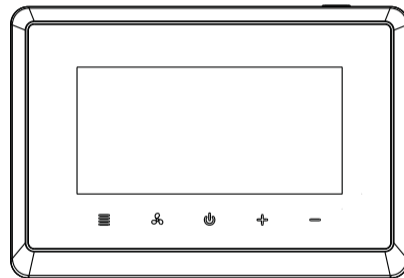

T29UTW-7-WIFI(TY)

Specifications -----	01
Thermostat's Appearance-----	02
Thermostat Installation -----	06
First Time Setting -----	07
System Setting -----	08
Programming Settings -----	10
Fan Speed Setting -----	16
Cooling and Heating Modes -----	17
Child Lock -----	18
Errod Warning -----	19
Configuration Menu -----	20
Install your thermostat with a C wire -----	30
Install your thermostat without a C wire -----	38
Accessory -----	53
APP -----	58

Specifications

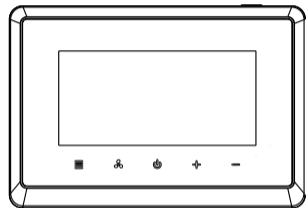

T29UTW-7-WIFI(TY)
thermostat

- Power source : 18-30VAC 50/60Hz
- IP Rating : IP21
- Temperature setting range : 41°F~95°F
- Temperature setting accuracy: 1°F
- Temperature display range :32°F~122°F
- Temperature accuracy : 0.1°F
- Operation temperature range : 32°F~122°F
- Shipping & storage temperature : 14°F ~ 140°F
- Output : Fan Relay Load I_{max} 24V/(0.5A)
Compressor/Valve Relay Load I_{max} 24V/(0.5A)

Thermostat's appearance

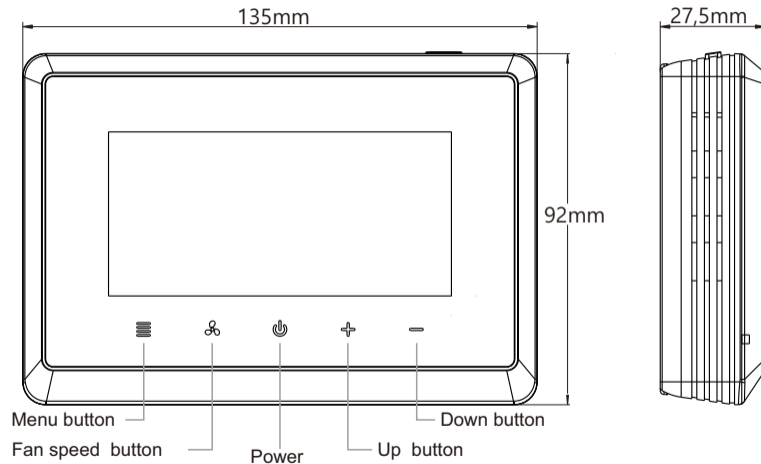

☰ Mode button

1. Under power on status, short press ☰ button to switch the mode, long press ☰ button to enter the programming settings. Under programming setting status, short press ☰ button to enter the next item.
2. Under power off status, long press ☰ button to enter the menu setting. Short press ☰ button under menu setting state to enter the next item.

🌀 Fan speed button

1. Under power-on status, short press 🌀 button to switch the wind speed mode. Long press 🌀 button to enter time query. Under time query or setting status, short press 🌀 button to enter the next time setting.
2. Under power off status, short press ☰ button in menu setting state to enter the previous item.

🔌 Power button

1. In power on, short press 🔌 to save and exist the time/program setting; short press 🔌 to enter into work state. Power off, long press 🔌 to remove WIFI and enter into network pair state.
2. In power off, short press 🔌 to power on.

+ Increase button

- Decrease button

- * In power on, press increase button and decrease button simultaneously to activate key lock.
- * Without holiday mode and hold mode

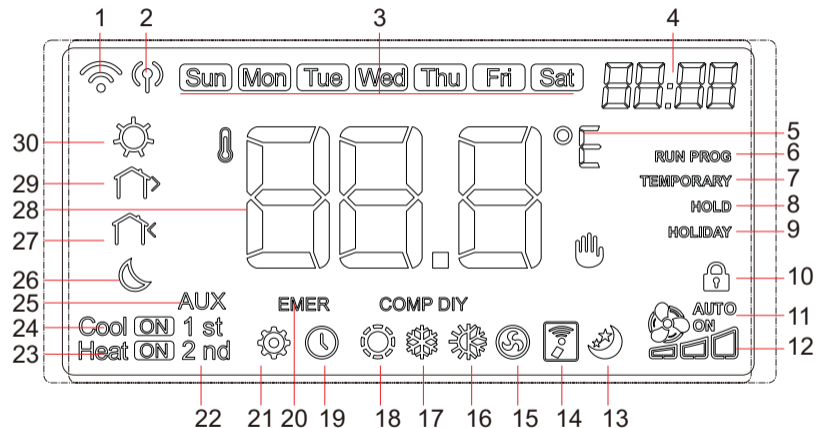

- 1: WIFI icon: Flashing indicates the WIFI in connection,static indicates successful connection
- 2: Fast flash indicates the network configuration status, Slow flash indicates AP connect network status.
- 3: Week
- 4: Temperature setting, Time setting, Parameter setting
- 5: Temperature unit
- 6: Program run
- 7: Temporary mode
- 8: Permanent mode
- 9: Holiday mode
- 10: Key lock
- 11: Indicate Fan AUTO/ON
- 12: Indicate Filter alarm
- 13: Indicates leave home mode
- 14: Indicate UV light alarm
- 15: Indicate fresh air output
- 16: Indicate Auto mode
- 17: Indicate cooling mode
- 18: Indicate heating mode
- 19: Indicate clock
- 20: Indicate Emergency and Auxiliary Heat mode
- 21: Setting
- 22: 1 stage or 2 stage output
- 23: Heating Output
- 24: Cooling Output
- 25: Assistant Heating Output
- 26: Sleep
- 27: Return
- 28: Temperature Sampling
- 29: Leave
- 30: Wake

Thermostat Installation

1. Unscrew terminal protective jacket then wiring.

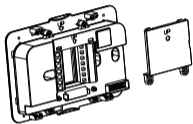

3. Install and fasten foundation, embed in display module.

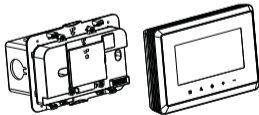

2. After wired the terminal protective jacket install the screw.



4. Installation finished.

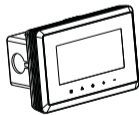

First Time Setting

Set the current actual time and week.

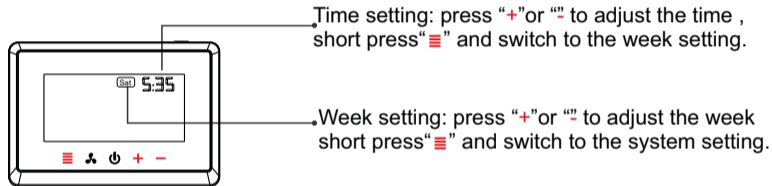

System Setting

(Multistage system)

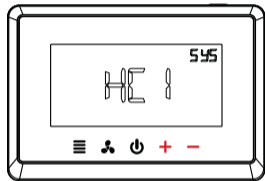

1.press "+" or "-" to select the primary system .

Parameter options:(CO1,CO2,HE1,HE2,HC1,HC2,HP1,HP2,HPA)

CO1:1 cool conventional

CO2: 2 cool conventional

HE1: 1 heat conventional

HE2: 2 heat conventional

HC1: 1 heat/1 cool conventional

HC2: 2 heat/2 cool conventional

HP1: 1 compressor heat pump,1-AUX

HP2: 2 compressors or 2 speed compressor heat pump,1-AUX

HPA: 2 compressors or 2 speed compressor heat pump, 2-AUX

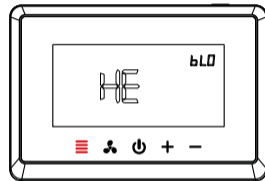

2.press "☰" to confirm the selection system

HE: Electric backup heat

HA:Fossil fuel backup heat

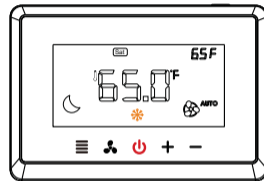

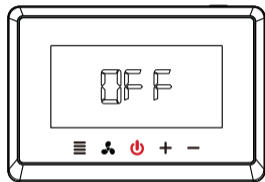

3. System setup completed, press "☰" to return to the main interface

Programming Settings

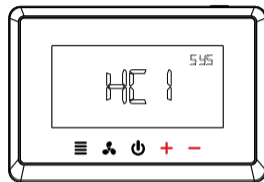

1. Short press the power button “”, and then the screen shows “OFF”.



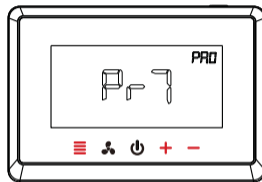

2. Long press the menu button “” for 5s until the system selection interface is displayed and select the system set up previously .

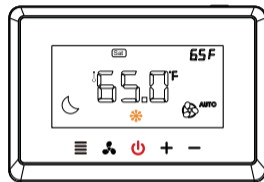

3. After system selection, select programming mode: press “+” or “-” for switch the programming mode (Pr0/Pr2/Pr7), and press “” to confirm and save the options.
Pr0: Non-programmable
Pr2: Work days+Friday&Saturday
Pr7: 7 days individually programming



4. Short press the power button “”, and the screen shows “OFF”, then short press the power button “” again to enter the programming main interface

7 days programming-Time/temperature setting

Separate programming settings for each day (Pr7)
(the programming setting are different from Sunday to Monday)

The are 4 periods each day by default

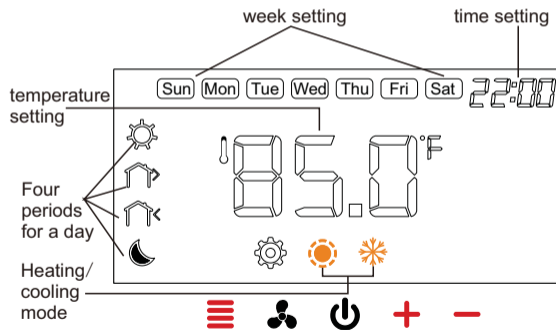

- 1.Week setting
- 2.Time setting
- 3.Temperature setting



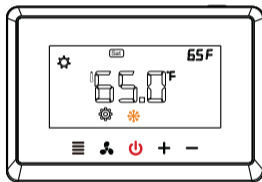

press “+”“-” to adjust the week / time / temperature, short short press“≡” to save the setting and switch to next period setting.

long press “≡” for 5s to switch the heating mode or cooling mode



5.Long press the menu button “≡” for 5s to enter the programming setting.
please Keep all the buttons lights on before performing this operation,if not, please press “⏻”





Default setting (heating)

week periods	Sun	Mon	Tue	Wed	Thu	Fri	Sat
 6:00 Morning	72°F	72°F	72°F	72°F	72°F	72°F	72°F
 8:00 Out door	61°F	61°F	61°F	61°F	61°F	61°F	61°F
 18:00 Back home	72°F	72°F	72°F	72°F	72°F	72°F	72°F
 22:00 Night	61°F	61°F	61°F	61°F	61°F	61°F	61°F



Exit programming settings : short press power button “14

Default setting (cooling)

week periods	Sun	Mon	Tue	Wed	Thu	Fri	Sat
 6:00 Morning	77°F	77°F	77°F	77°F	77°F	77°F	77°F
 8:00 Out door	82°F	82°F	82°F	82°F	82°F	82°F	82°F
 18:00 Back home	77°F	77°F	77°F	77°F	77°F	77°F	77°F
 22:00 Night	82°F	82°F	82°F	82°F	82°F	82°F	82°F



Restore default setting: long press “+” and “-” for more than 5s until the screen shows “DEF” and the “DEF” flash 3 times.

Fan speed setting

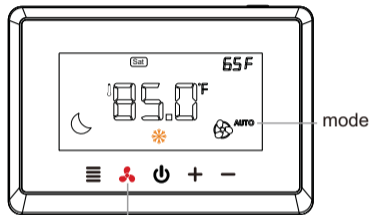

Fan speed
button

Fan speed mode setting : short press
“” for switching “AUTO” or “ON” mode.



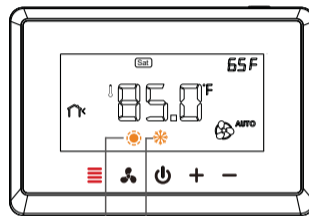

AUTO:Automatic mode

ON:FAN ON mode

Cooling and Heating Modes



Heating
mode Cooling
mode

Short press the menu button
“” for switching cooling mode
“” or heating mode “” or
single speed fan mode “”

Child Lock

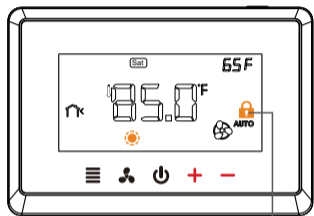

Child lock

Press the “+” and “-” buttons for 5s at the same time to open / close the child lock “🔒”.

Error Warning



Room Temp(inside room sensor) broken or short cut,the thermostat will have “Err”

Configuration Menu

The configuration menu setting :

1. In the state of shutdown, long press menu button "☰" for 5s to enter the configuration parameter programming setting.
2. Press "+" or "-" to select the configuration parameter setting, then press "☰" to save and switch to the next item setting.
3. After all the parameters are set up, press power button "⏻" exit the setting and return to the OFF stage.

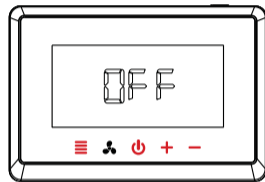

- * 1. The thermostat will exit the configuration parameter setting automatically and return to the shutdown state if there is no any operation within 30s.
- 2. Restore default setting: during setup, long press "+" and "-" for more than 5s until the screen shows "dEF" and the "dEF" flash 3 times.

System type option(SYS)

Parameter options:(CO1,CO2,HE1,HE2,HC1,HC2,HP1,HP2,HPA)

CO1: 1 cool conventional

CO2: 2 cool conventional

HE1: 1 heat conventional

HE2: 2 heat conventional

HC1: 1 heat/1 cool conventional

HC2: 2 heat/2 cool conventional

HP1: 1 compressor heat pump, 1-AUX

HP2: 2 compressors or 2 speed compressor heat pump, 1-AUX

HPA: 2 compressors or 2 speed compressor heat pump, 2-AUX

Factory default: HC1

Intelligent recovery option (rEC)

Parameter options:(OFF,ON)

OFF: Deactivate the intelligent recovery function

ON: Activate the intelligent recovery function

Factory default:OFF

Manual/Autochangeover option(CHA)

Parameter options: (0,1)

0: Manual changeover

1: Auto changeover

Factory default:0

First cooling cycle rate(CCY)

Parameter options:(1°F~6°F)

Factory default:1°F

First heating cycle rate(HCY)

Parameter options:(1°F~6°F)

Factory default:1°F

Second cooling cycle rate(C2S)

Parameter options:(1°F~6°F)

Factory default:1°F

Second heating cycle rate(H2S)

Parameter options:(1°F~6°F)

Factory default:1°F

Emergency heat cycle rate(CrY)

Parameter options:(1°F~6°F)

Factory default:1°F

Compressor lockout delay option(dEL)

Parameter options:(0~5)

To protect the compressor from short cycling, you can select compressor off-time cycle between 0~5 minutes

Factory default:3

★ When the thermostat compressor time delay occurs, lockout.

No heat pump heat type option(BLO)

Parameter options:(HA,HE)

HA: Fossil fuel backup heat

HE: Electric backup heat

Factory default:HE

★ HP1, HP2 and HPA system are Auxiliary heating

Display backlight option(BLL)

Parameter options:(1,2)

1:No backlight display

2:The backlight come on for approximately 30s when any button is touched

Factory default:2

Temperature recalibration option(CAL)

Parameter options:(-8~+8°F)

Factory default:0

°F or °C readout option(FC)

Parameter options:(°F , °C)

Factory default:°F

Program option(Pr0)

Parameter options:(Pr7,Pr0)

Pr7: 7-day program function for the thermostat

Pr0: non-program function for the thermostat

Factory default:Pr7

17. Filter replacement run time option(FIL)

Parameter options:(00-12)

This is a reminder to change or clean your air filter. This time can be set from 0 to 12 months in 1 month increments.

Factory default: 00

- ★ 1.The thermostat will display the “” after a set time of operation.
- 2.Selection of 00 will cancel the function.

18. UV lamp replacement run time option(UUL)

Parameter options:(ON,OFF)

ON: It means starts to counting for 0 day to 400 day

OFF: It means cancel the function

Factory default:OFF

- ★ The thermostat will display the “” when UV time(400 days) has expired.

20. Remote sensor option(SEn)

Parameter options:(0,1,2)

0: No remote sensor

1: Outdoor control sensor (See Menu item 21 Heat pump temperature lockout)

2: Indoor sensor. if the thermostat is installed with an indoor remote sensor, display will show the read temperature from the indoor sensor.

Factory default:0

- ★ If the option is 1,2,please choose NTC-10 sensor.

Heat pump compressor lockout option(HPL)

Parameter options:(0°F,15°F, 20°F,25°F,30°F,35°F,40°F)

0: No heat pump compressor lockout

15°F, 20°F, 25°F, 30°F, 35°F, 40°F:heat pump compressor lockout temperature

Factory default:0

 This option apply only to HP1, HP2, HPA setting in system type option and only works when remote sensor option (menu item 20) is set 2.

Heat pump auxiliary heating temperature lockout option(AUL)

Parameter options:(0°F, 40°F, 45°F, 50°F, 55°F, 60°F)

0: No auxiliary heating temperature lockout

40°F, 45°F, 50°F, 55°F, 60°F: heat pump auxiliary heating temperature lockout

Factory default:0

 This option apply only to HP1, Hp2, HPA setting in system type option and only works when remote sensor option (menu item 20) is set 2.

Auto changeover dead band option(dbA)

Parameter options:(4~8°F)

Factory default:4°F

O/B port selection direction(Ob)

O: O/b terminal is output in cooling mode

b: O/b terminal is output in heating mode

Factory default: b

ventilator(FAN)

0~60 min

Factory default: 0

☑ CHECKPOINT: C WIRE

Do you have a C wire connected to your old thermostat?

YES

Great, please continue to the **NEXT PAGE**.

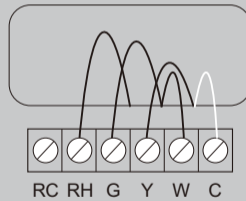

NO

Go to install with a ECM.

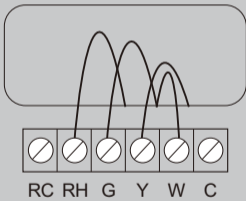
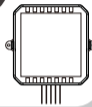

💡 TIPS:

The wiring on your old thermostat may look different, just check to see if there's a C wire.

Install your thermostat with a C wire

If you have a C wire, it will power your thermostat. you won't need the Electric Control Module included in the box.

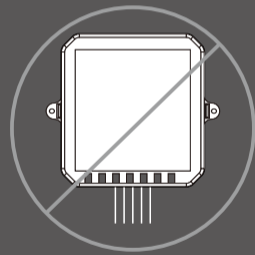

💡 TIPS:

TO install accessories (humidifier, dehumidifier or ventilator) please refer to the wiring diagrams at wiring.

STEP1

Carefully disconnect and label the wires from your old thermostat one at a time, using the labels provided.

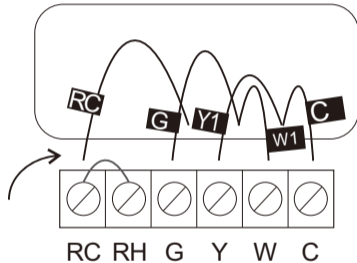

 **TIPS:**

If you have a jumper between RC, RH, OR R, leave it alone.
Only label the wires that run from your wall into a terminal block.

STEP2

Unscrew the mounting plate of your old thermostat to remove it from the wall.

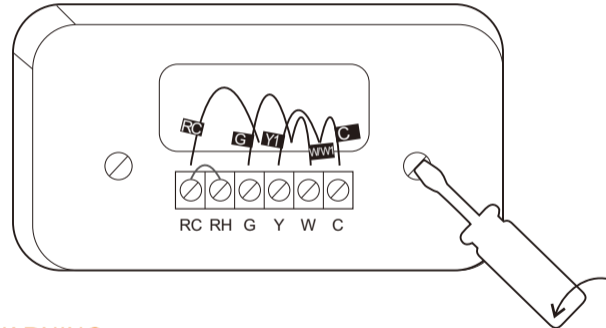

 **WARNING:**

Be careful, as some thermostat may contain mercury.
Recycle your old thermostat safely with your local hazardous waste facility.

CHECKPOINT: INSERT YOUR R WIRE(S)

Do you have more than one R wire?
(That includes R,RC,and RH)

YES

Insert your wires:
R or RC → RC
RH → RH

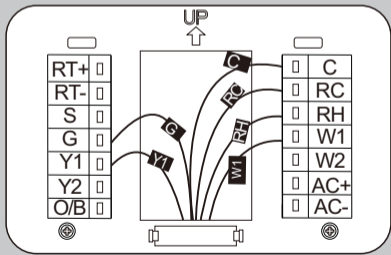

NO

Insert your single wire:
R,RC,or RH → RC

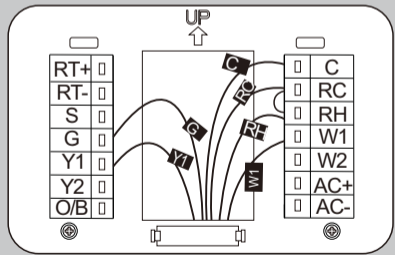

* **Note:** Do not jumper RC or RH

STEP3

Insert your remaining wires into the side (not the front) of their corresponding terminal blocks.

STEP4

Tug on the wire gently to ensure they are securely connected.

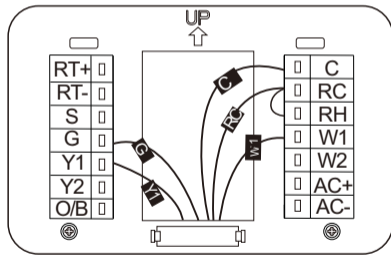

TIPS:

1. Press the terminal block levers to insert the wires more easily.
2. When a wire has been connected correctly, the level on the block will lower.

STEP5

Carefully push any excess wires back into the hole and ensure there are no drafts coming from the hole(s) in the wall.

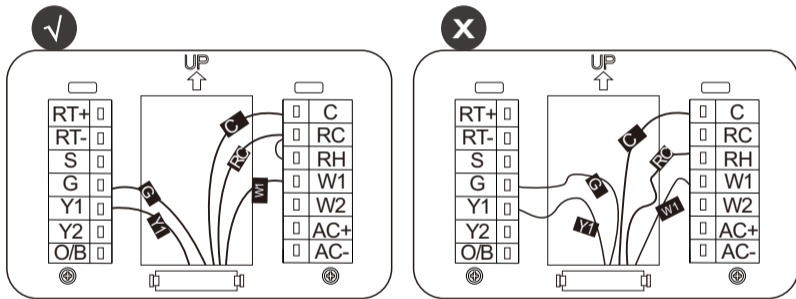

 **TIPS:**

Large holes behind your thermostat will affect temperature readings. Prevent drafts by covering the holes.

STEP6

Turn the power to your HVAC system back on using the master switch or at the circuit breaker box.

Congratulations, you did it!

Say hi to your new thermostat! To complete your setup and registrations, follow the instructions on your thermostat screen.

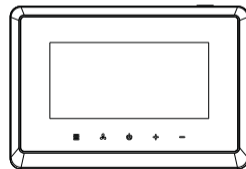

Install your thermostat without a C wire

If you don't have a C wire, you will need to use the Electric Control Module included to reliably power your thermostat.

(Optional 4 to 5 wires)



CHECKPOINT: 3 OR 4 WIRES

The Electric Control Module requires your system to have either of the following: 4 wires W/W1, Y/Y1, G, and R (or RC or RH)
Do you have these wires?

YES

Great, please continue to the **NEXT PAGE**.
The Electric Control Module will work with your system!

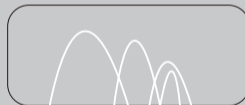

RC RH G Y W C

NO

Please check compatibility or contact us!



RC RH G Y W C

STEP1

Take your Electric Control Module ,wire labels, tools, your smart-phone, and go to your HVAC system.

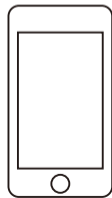
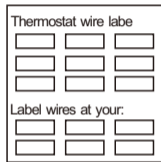
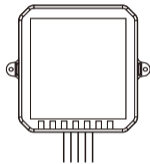

STEP2

Open your HVAC system's cover to reveal at control board.

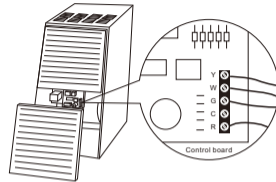

STEP3

Take a picture of the wires connected to your control board. You may need to reference this photo later on.

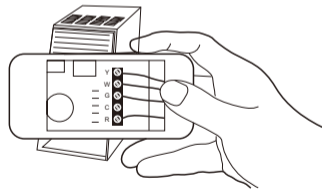

WARNING:

HVAC system contain high voltage wires. Use caution when working with the control board. If you'd rather leave it up to a professional.

STEP4

Label only the R,Y,or Y1,G,and W or W1 wires with the matching labels provided.
If you have more than one wire going into these terminals, only label those going to your thermostat.

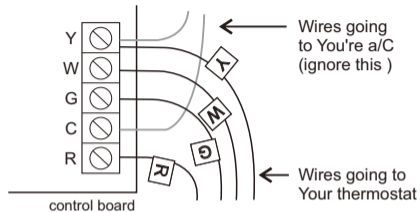

STEP5

Disconnect the wires labeled R,Y,G,and W from the control board.

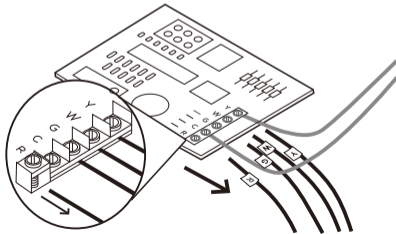

STEP6

Connect the wires you disconnected from the control board into their matching gray terminal blocks on the Electric Control Module.

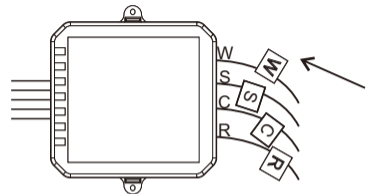

STEP7

Tug on the wires gently to ensure they are securely connected.

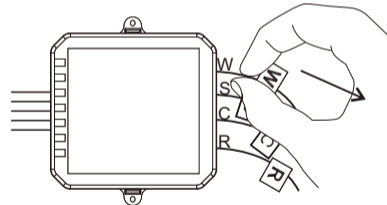

💡 TIPS:

- 1.Press the buttons to insert the wires more easily.
- 2.When a wire has been connected correctly, the button on that block will lower.

STEP8

Connect the five white wires coming out of your Electric Control Module to their corresponding terminals on the control board .

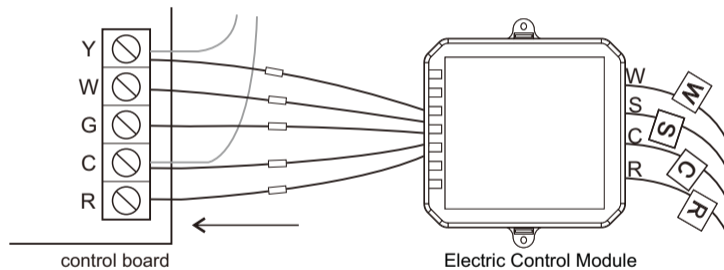

☑ CHECKPOINT: Electric Control Module

Check that you have installed the Electric Control Module correctly. It should be installed between your thermostat wiring and your control board.

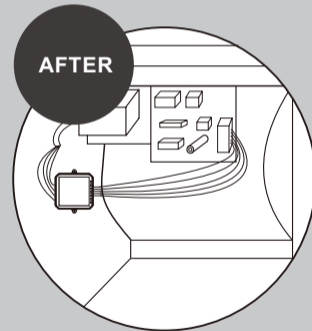
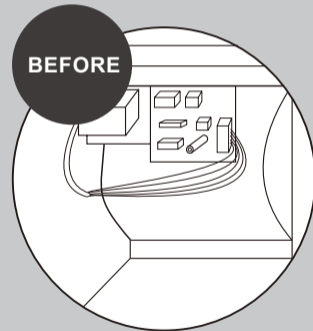

STEP9

Mount the Electric Control Module inside your HVAC system, taking care not to strain the wires.
Close the HVAC cover panel securely return to your thermostat.

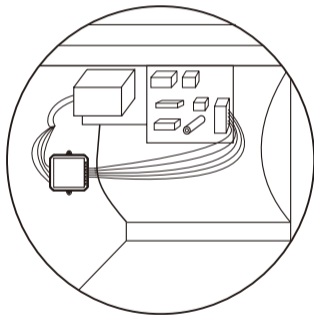

TIPS:

Make sure your HVAC panel is fully closed. Some systems will not turn on if the cover panel has not been closed properly.

STEP10

Back at your thermostat:

Carefully disconnect and label the wires from your old thermostat one at a time, using the labels provided.

If you have a jumper between RC, RH, or R leave it alone.

Only label the wires that run from your wall into a terminal block.

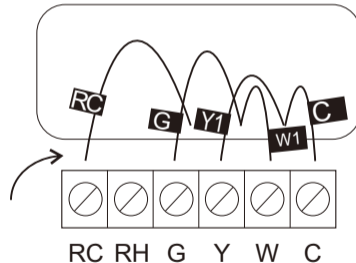

STEP11

Unscrew the mounting plate of your old thermostat to remove it from the wall.

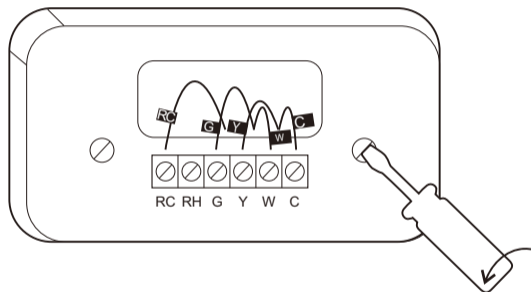

⚠ WARNING:
Be careful, as some thermostat may contain mercury.
Recycle your old thermostat safely with your local hazardous waste facility.

STEP12

Remove the RC, C and S labels from the label sheet and attach them to the wires as shown below:

R/RC/RH → RC

G → C

Y → S

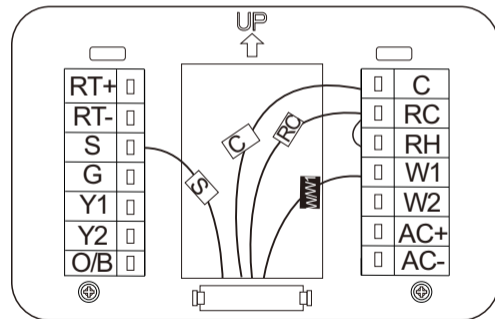

STEP13

First, connect these 3 wires as show: RC,C,S. Then connect any remaining wires to their corresponding terminal.

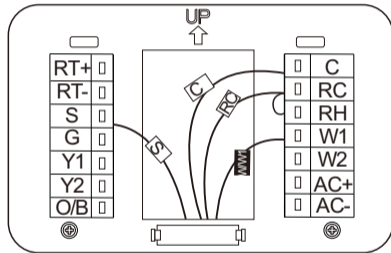

 **TIPS:**

1. Press the terminal block levers to insert the wires more easily.
2. When a wire has been connected correctly, the level on the block will lower.

STEP14

Gently press your thermostat into the backplate until it “clicks” into place.

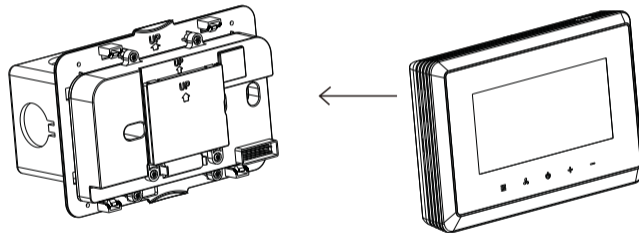

 **TIPS:**

If the thermostat “rocks” or is not flush with the wall, be sure the excess wires are pushed all the way into the wall.

STEP 15

Turn the power to your HVAC system back on using the master switch or at the circuit breaker box.

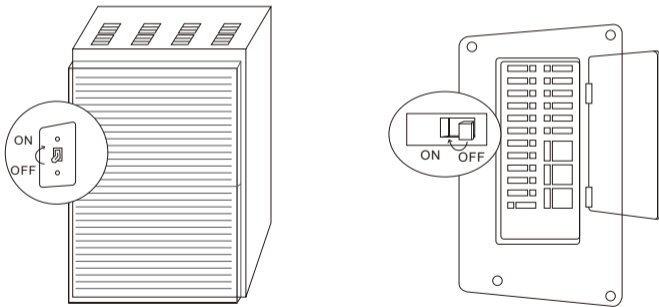

Boiler or radiant system with air handler and conventional cooling or heat pump.

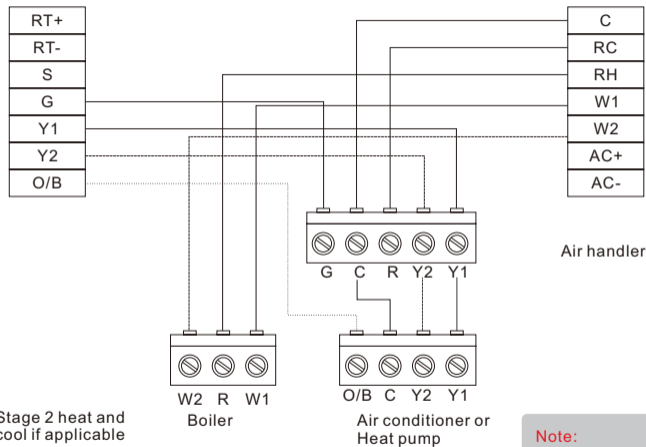

Note:
Do not jumper RC or RH

Accessory devices

The T29 can control an accessory HVAC device like a humidifier, dehumidifier, or ventilation device from its AC terminals

Note: You will need to configure the accessory device when you first power on your T29.

2-wire accessory (ventilator)

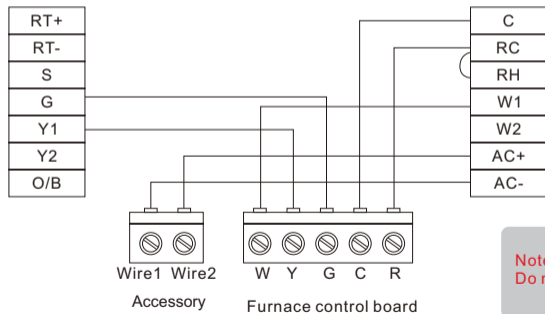

Note:
Do not jumper RH or AC+

1-wire accessory

(ventilator)

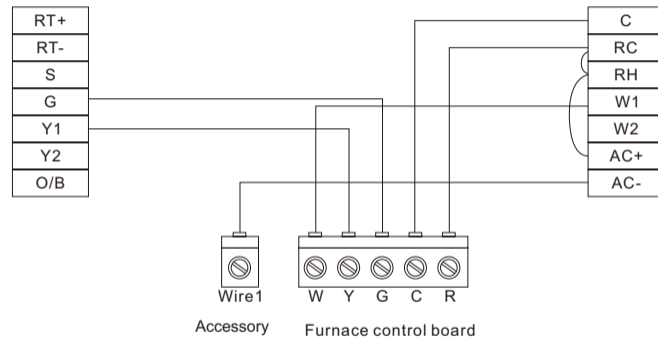

T29 automatically connects Rc to AC- when 1-wire configuration is selected during accessory setup.



Warning: Damage may occur if accessory is connected to AC-

Wiring must comply with applicable codes, ordinances and regulations.

1. Wire the NTK100 Outdoor Sensor to the RT+/RT- terminals on the thermostat. If the lead wire provided with the NTC-100K is not long enough, run cable to a hole at the selected NTC-10K location. Color-coded, 18-gauge thermostat wire is recommended. For an example of general wiring of the NTC-100K, see Fig. 2. Pigtail wiring can be used.
2. Mount the NTC-100K in its mounting clip.
3. Plug wiring hole using nonhardening caulk or putty.

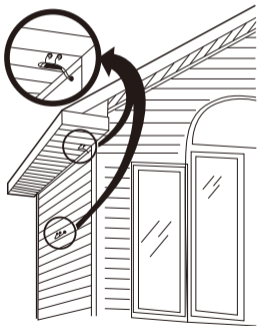
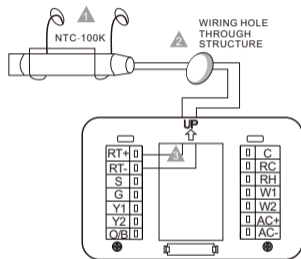

Fig. 1. Typical locations for outdoor sensor.



- ▲ Use appropriate mounting means for the type of structure.
- ▲ Plug wiring hole with non-hardening caulk or putty.
- ▲ RT+/RT- terminal location varies with model.

Fig. 2. Wiring diagram for the NTC-100K Outdoor Sensor to the thermostat.

Optional sensor

SASWELL NTC 100K Room Sensor With 3 Meter Wiring

*Used for outdoor temperature detection when there is water pump protection.



Link Alexa

Required: The account of Tuya smart and AmazonAlexa must be the same.

Long press the reset button for 6s, Alexa said "Now in setup mode, follow the instructions on your alexa APP"



① Open the APP of Amazon Alexa

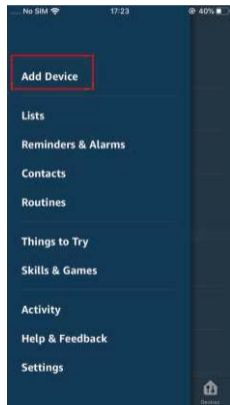

② Add Device



③ Amazon Echo



④ Echo Dot



⑤ Select your Echo Dot



⑥ CONTINUE

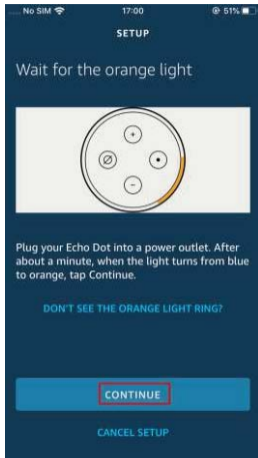

7 CONTINUE



8 Find Amazon Device

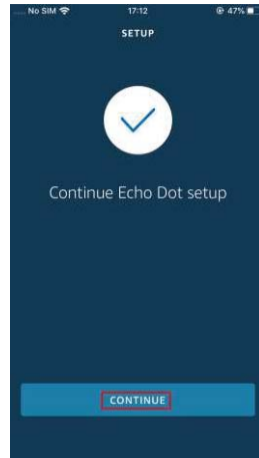

9 Continue

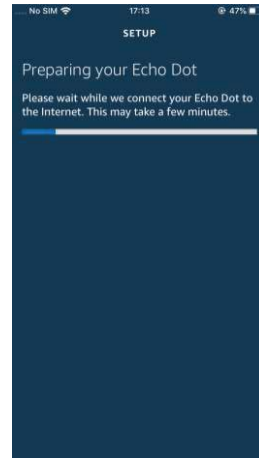

10 Select your WIFI network

11 Preparing your Echo Dot.
Then the Alexa said
"Your Echo Dot is ready"



12 It will access the SETUP and reconnect your WIFI network automatically



13 Link to Alexa successfully.

How to change Fahrenheit and Celsius



1 Device List

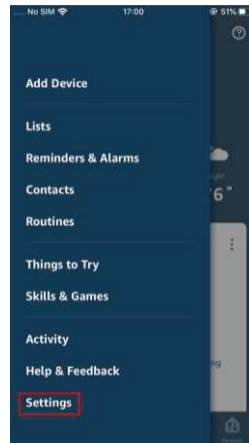

2 Settings



3 Device Settings



④ niyoudian's Echo Dot



⑤ Measurement Unit

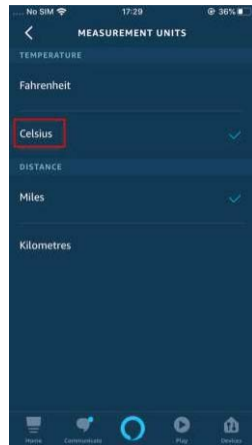

⑥ Select Fahrenheit or Celsius

Link to TUYA



① Device list "+"



② Socket (Wi-Fi)



③ Confirm indicator rapidly blink

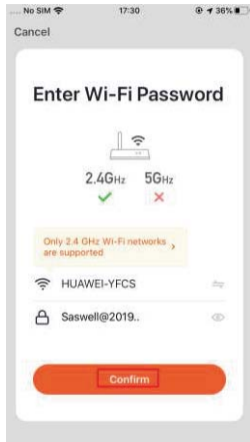

④ Only 2.4G Wi-Fi networks are supported, Confirm



⑤ Connecting

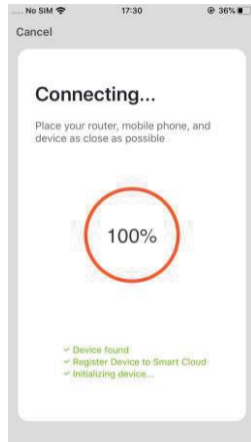

⑥ Connecting successfully



⑦ Done



⑧ Add Subdevice

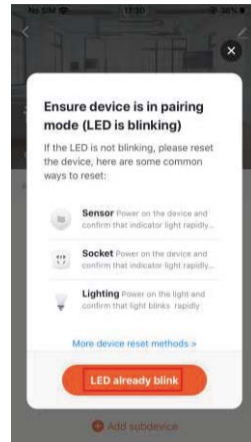

⑨ LED already Blink

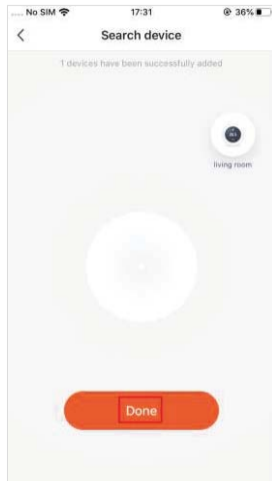

⑩ Done

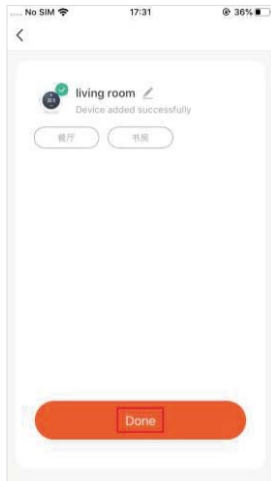

⑪ Done

FCC Radiation Exposure Statement:

This equipment complies with FCC radiation exposure limits set forth for an uncontrolled environment. This equipment should be installed and operated with minimum distance 20cm between the radiator & your body.

FCC Warning

This device complies with Part 15 of the FCC Rules. Operation is subject to the following two conditions:

- (1) This device may not cause harmful interference,
- (2) This device must accept any interference received, including interference that may cause undesired operation.

NOTE 1: This equipment has been tested and found to comply with the limits for a Class B digital device, pursuant to part 15 of the FCC Rules. These limits are designed to provide reasonable protection against harmful interference in a residential installation. This equipment generates uses and can radiate radio frequency energy and, if not installed and used in accordance with the instructions, may cause harmful interference to radio communications. However, there is no guarantee that interference will not occur in a particular installation. If this equipment does cause harmful interference to radio or television reception, which can be determined by turning the equipment off and on, the user is encouraged to try to correct the interference by one or more of the following measures:

- Reorient or relocate the receiving antenna.
- Increase the separation between the equipment and receiver.
- Connect the equipment into an outlet on a circuit different from that to which the receiver is connected.
- Consult the dealer or an experienced radio/TV technician for help.

NOTE 2: Any changes or modifications to this unit not expressly approved by the party responsible for compliance could void the user's authority to operate the equipment.