

◆C79X2_WLAN module Label

ラベル図
Label

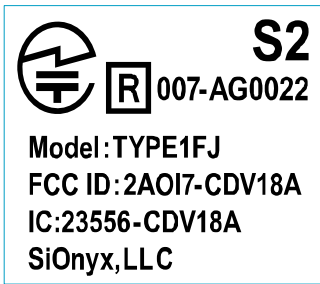

材質構成図

Material composition

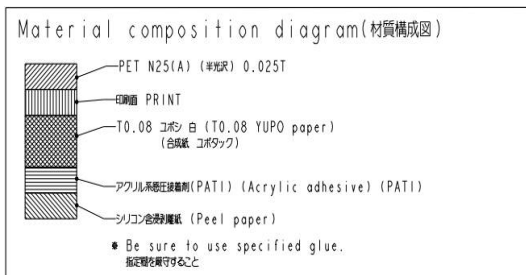

ラベル配置図

Label

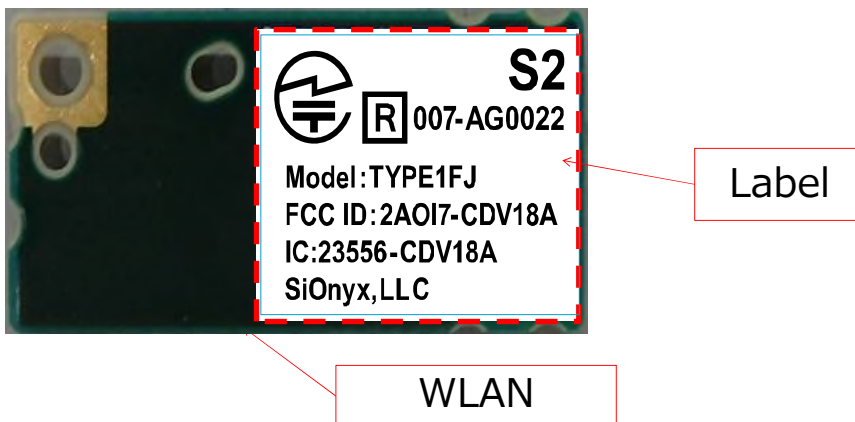

認証マーク寸法

Label size

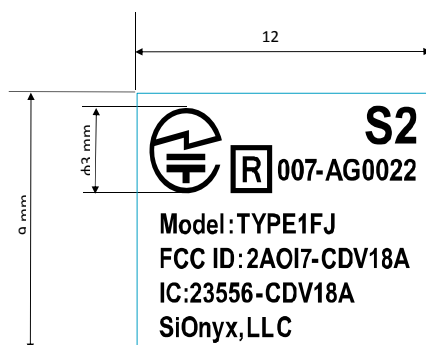

◆C79X2_Rating Label

ラベル図

Label



材質構成図 Material composition

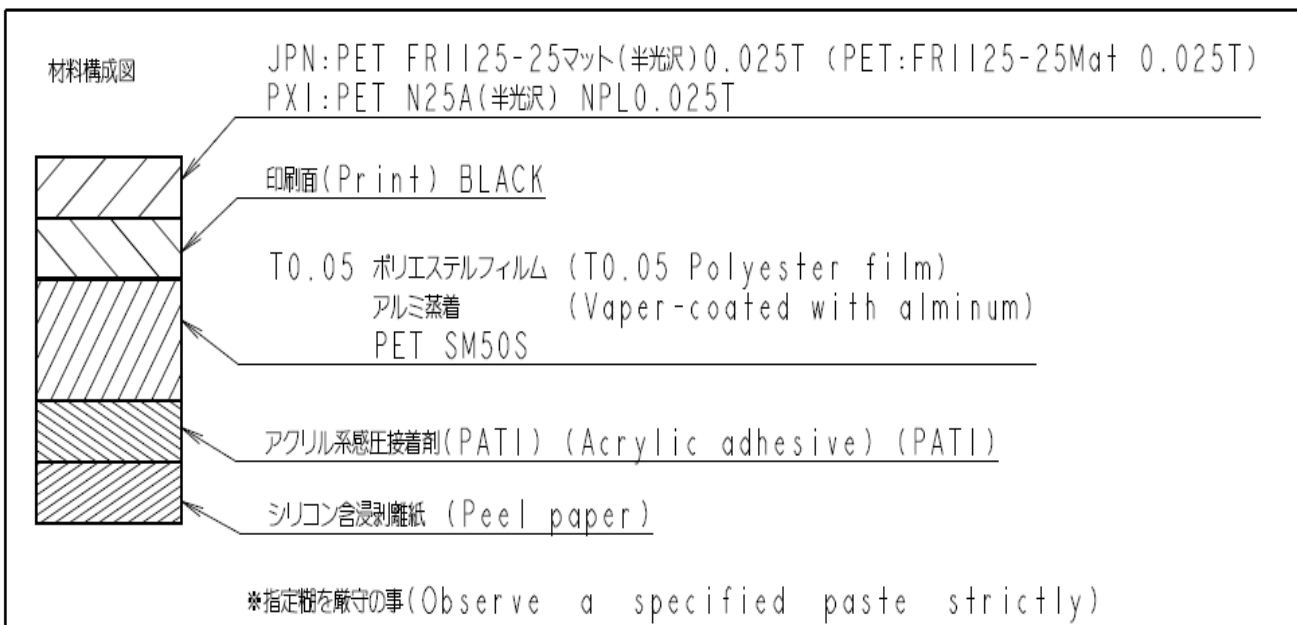

ラベル配置図
Label layout

Rating

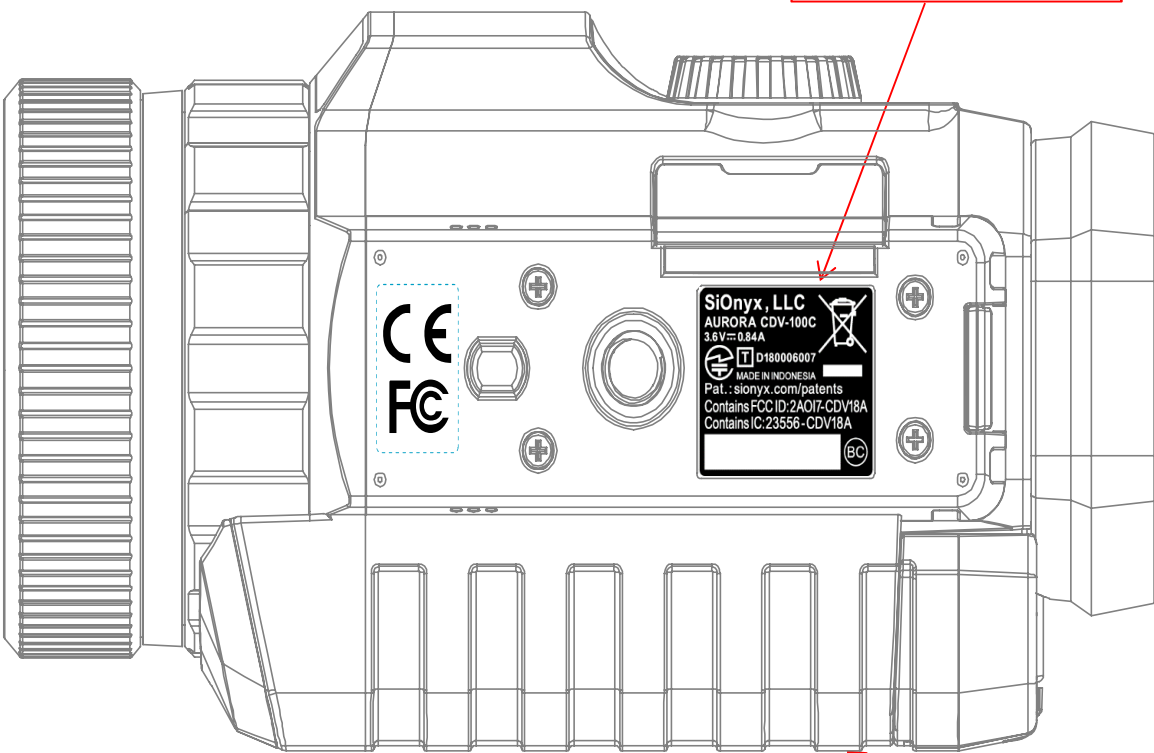

CDV-

認証マーク寸
法Label size

17.75 mm

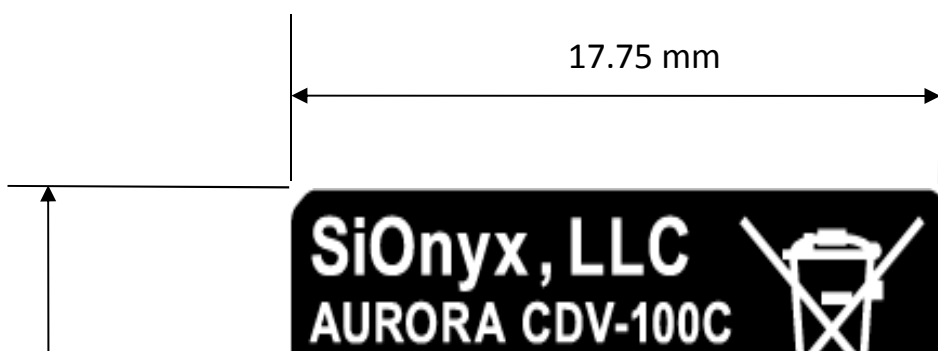

16.05 mm

φ3 mm

3.6V  0.84A

  D180006007 

MADE IN INDONESIA 

Pat. : sionyx.com/patents

Contains FCC ID:2A0I7-CDV18A

Contains IC:23556-CDV18A