

Thundercomm

Empowering Every IoT Device with Our Technology

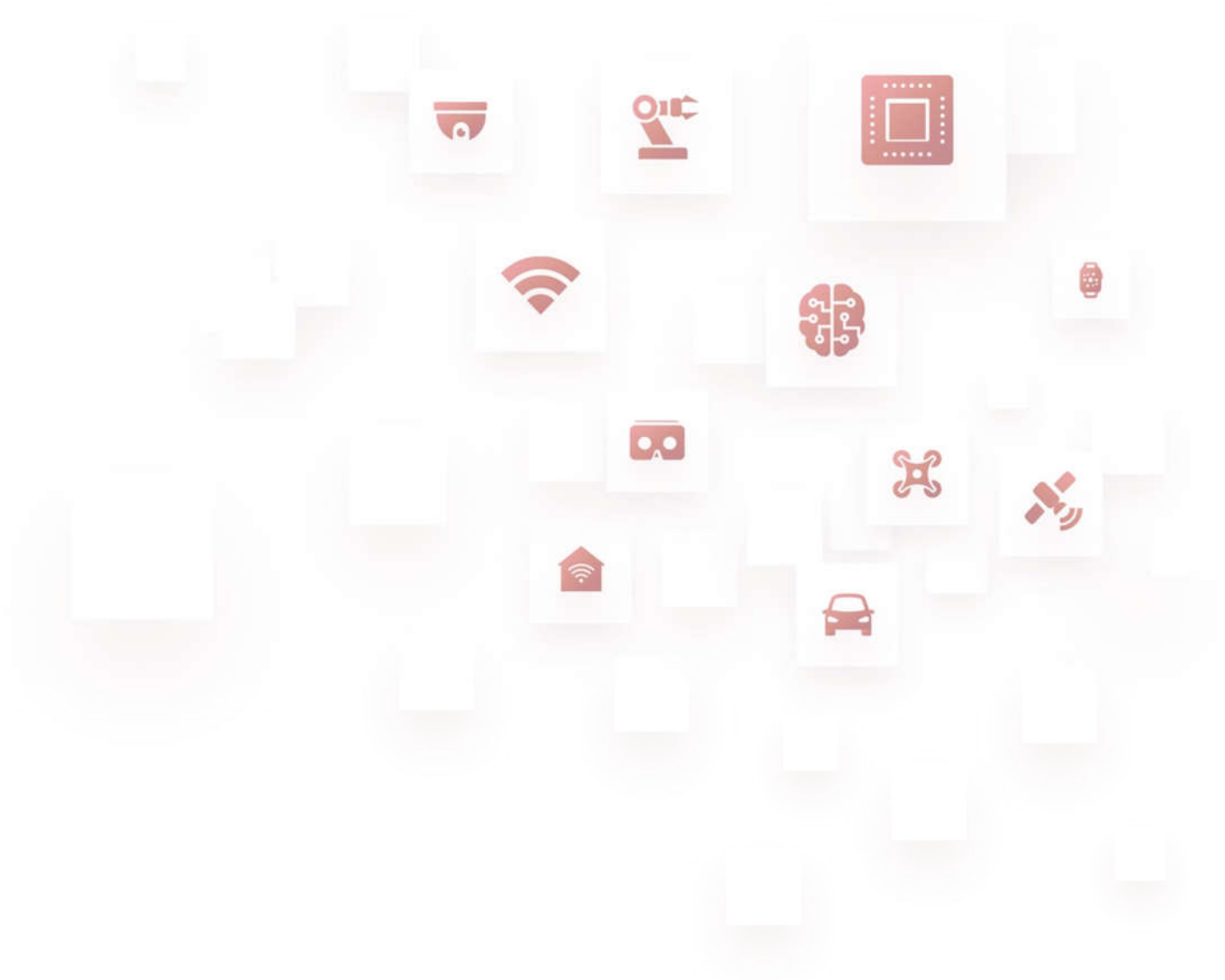

Thundercomm TurboX CM6125 Development Kit

Hardware User Manual

Table of Contents

Chapter 1. Product Overview	- 2 -
1.1. Features and specifications	- 3 -
1.2. Product diagram	- 4 -
1.3. Development kit introduction	- 5 -
1.4. DIP switches.....	- 11 -
Chapter 2. Specifications for CM6125 DK.....	- 15 -
2.1. Main Board	- 15 -
2.2. Interposer Board.....	- 29 -
2.3. Audio Board.....	- 31 -
2.4. Sensor Board.....	- 32 -
Appendix 1. Compliance and Certificate Information	- 34 -
Appendix 2. Contact Information of EU Local Agency	- 39 -
Appendix 3. Contact Information of US Local Agency	- 40 -
Appendix 4. Notices.....	- 41 -
Appendix 5. Trademarks.....	- 43 -

Chapter 1. Product Overview

The TurboX CM6125 development kit is a cost-effective solution to evaluate the performance and build the prototype of the smart cameras and intelligent IoT devices quickly. The development kit features rich interfaces, including Type-C USB, LCD, and camera modules. The development kit supports Android-S operating system, combining powerful artificial intelligence and machine learning to address increasing demand for smart cities, commercial and enterprise, homes, and vehicles applications.

☞ “TurboX” referred to herein is the English text of our registered trademark: **TURBO X**.

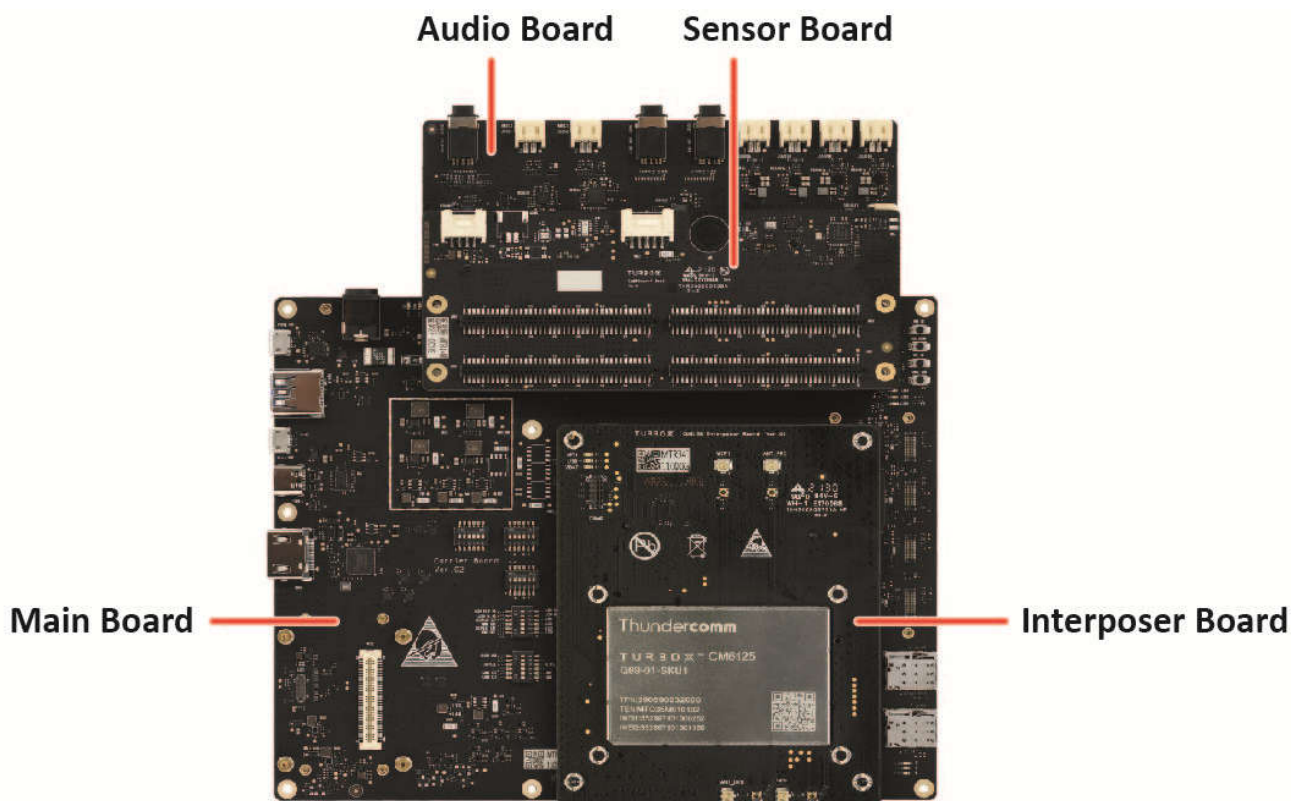

TurboX CM6125 Development Kit

Figure 1-1. CM6125 Development Kit - Board Identification

1.1. Features and specifications

Table 1-1. Features and specifications

Item	Specification
Processor	CPU: <ul style="list-style-type: none"> • Customized 64-bit Arm v-8.0 compliant applications processor (Qualcomm® Kryo™ 260 CPU) • Kryo Gold: quad-core (2.0 GHz high-performance) • Kryo Silver: quad-core (1.8 GHz low-power)
	GPU: Qualcomm® Adreno™ GPU 610 at 950 MHz graphics processing unit (GPU) with 64-bit addressing
	DSP: Qualcomm® Hexagon™ DSP with Qualcomm® Hexagon™ Vector eXtensions (dual HVX 512)
Memory	eMCP (eMMC 5.1 + LPDDR4X)
Multimedia	<ul style="list-style-type: none"> • Alternative of 4-lane MIPI DSI interface or LVDS interface • Three 4-lane MIPI CSI interfaces. • HDMI in and HDMI out 2.0 (TBD) • Native DisplayPort 1.4 • FM (WCN3950/WCN3980)
USB	<ul style="list-style-type: none"> • 1 x USB 3.0 Type-C device port • 1 x Micro USB 2.0 connector (for UART debug) • Onboard HUB: • 1 x USB host Type-C • 4 x USB Type-A
Ethernet	10BASE-Tc/100BASE-Tx/1000BASE-T IEEE 802.3 compliant
SDIO	1 x TF Card
Sensor	<ul style="list-style-type: none"> • 1 x IMU • 1 x ALS + Proximity • 1 x barometer • 1 x Mag sensor
Power supply	DC-Jack: 1 x 12 V DC in
Audio	<ul style="list-style-type: none"> • WCD9335 audio codec • 1 x 3.5 mm audio jack HP jack • 2 x WSA8815 audio amplifiers • 8x DMIC IN
Charger	PMI632 + SMB1355
Button	<ul style="list-style-type: none"> • 1 x Power on • 2 x Volume • 1 x Force_USB_boot
SIMs	2x UIM interface
Air interface	<ul style="list-style-type: none"> • GSM/WCDMA/LTE • WLAN • BT
Operating temperature	-25°C to +75°C

1.2. Product diagram

ComDK HW Diagram

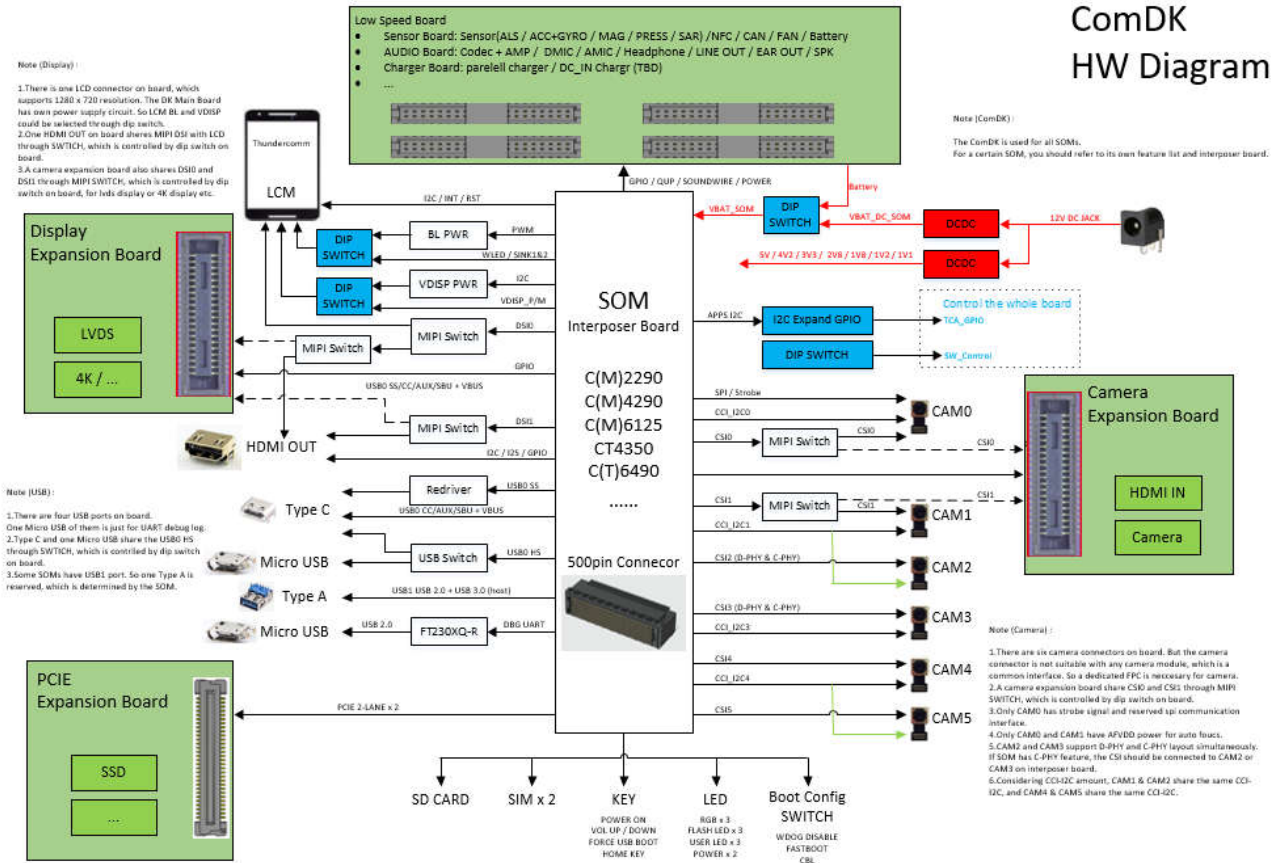

Figure 1-2. Main Board Block Diagram

NOTE: Camera module and TFT-LCD are accessories to the development kit.

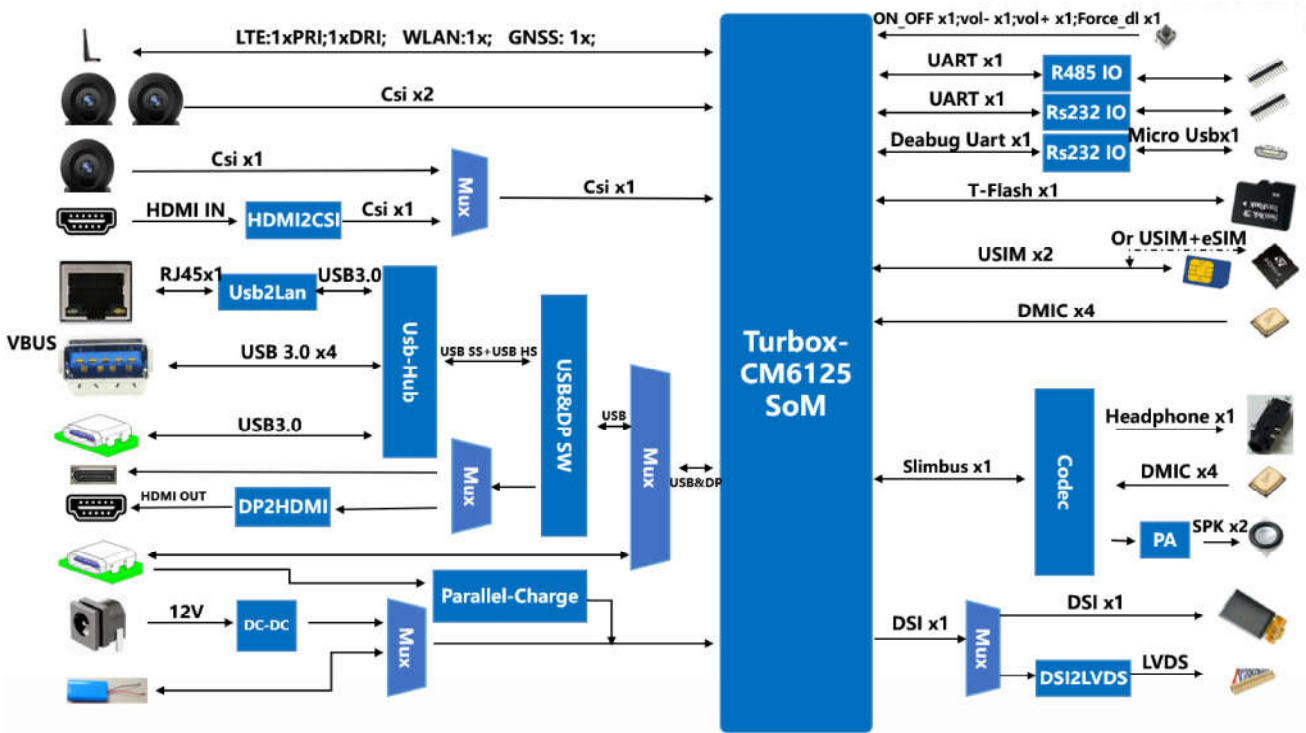

Figure 1-3. Interposer Board Block Diagram

1.3. Development kit introduction

TurboX CM6125 DK adopts TCSOM_Carrier which consists of various sub boards. CM6125 SOM is connected to the DK via the Interposer Board.

- Main Board

Core board of TCSOM_Carrier, adaptable to various SOMs via 500-pin connector. It mainly supports functions of USB, LCM, HDMI out, camera, SD card, SIM card, key, LED, etc. In addition, it can be connected to other expansion modules via rich peripheral interfaces including low-speed connectors, camera interface, display connector, PCIe expansion connector, etc.

- Interposer Board

Carrier board of SOM, transferring signal from SOM to the Main Board via 500-pin connector. It also contains all RF interfaces and special SOM interfaces (for example, eDP).

- Audio Board

This board is used together with the Main Board and is connected to the Main Board via the low-speed connectors. It contains codec WCD9385, amp WSA8835, and supports speaker, DMIC as well as headset functions.

- Sensor Board

This board is used together with the Main Board and is connected to the Main Board via the low-speed connectors. It is mainly used for sensors. In addition, it is fit for applications including battery, NFC, CAN, FAN, etc.

➡ To fit all the boards together, refer to [Figure 1-1](#).

Refer to the following sub sections for the detailed description of interfaces on each board.

1.1.1. Main Board overview

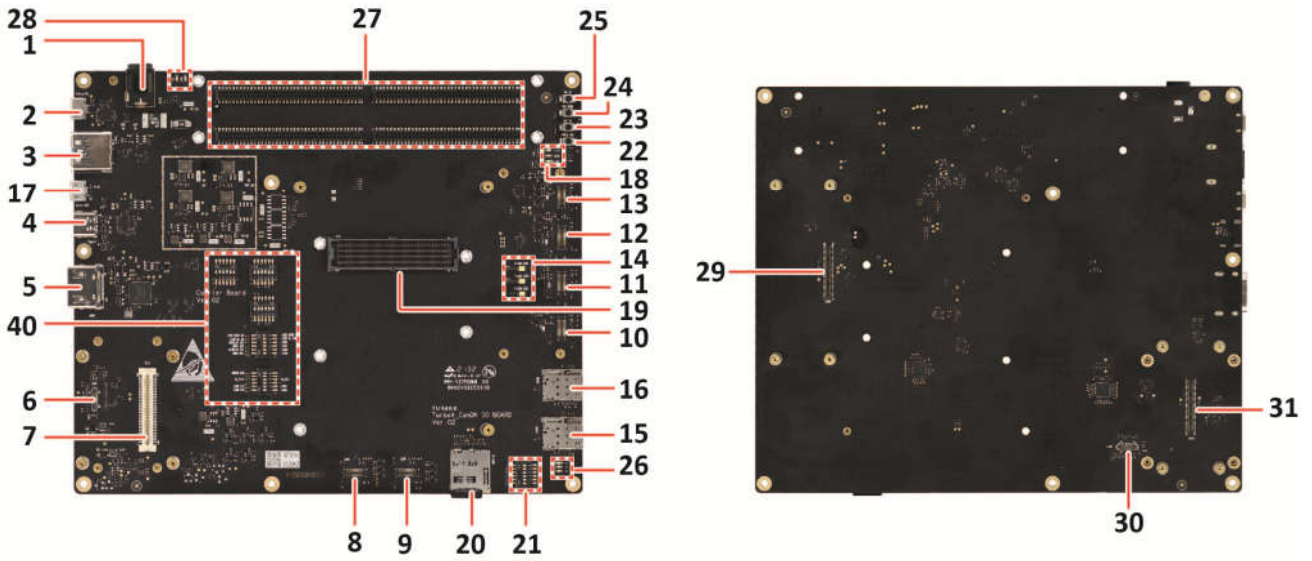

Figure 1-4. Main Board Overview

Table 1-2. Main Board interface list

Item	Reference	Description
1	J600	12V DC jack input, 2.5mm/5.5mm
2	USB3400	UART debug port, UART to USB
3	J3901 ^{a)}	USB Type-A port, only as host
17	USB3900 ^{b)}	Micro USB port, sharing DP/DM with USB Type C connector, adb /download/host/device
4	J3900	USB Type-C port, adb /download/host/device
5	J3800	HDMI out interface, 2.0
6	J3700 ^{c)}	LCD1 interface (option)
7	J1200	PCIe expansion module connector, 2 x 2-lane
8	J3401	Camera interface #5
9	J3400	Camera interface #4
10	J3300	Camera interface #2
11	J3301	Camera interface #3
12	J3200	Camera interface #0
13	J3201	Camera interface #1
14	LED4408 ^{d)}	LED4408, Flash LED #3
	LED4409	LED4409, Flash LED #2
	LED4410	LED4410, Flash LED #1
15	SIM4201	Nano SIM card slot #2
16	SIM4200	Nano SIM card slot #1
19	CON1000	500-pin connector to the Interposer Board
20	J4100	SD card slot

Item	Reference	Description
21	SW4404	6-pin switch, boot configuration and CBL <ul style="list-style-type: none"> • SW1, SDM_WDOG_DISABLE • SW2, SDM_FAST_BOOT_0 • SW3, SDM_FAST_BOOT_1 • SW4, SDM_FAST_BOOT_2 • SW5, SDM_FAST_BOOT_3 • SW6, CBL_PWR_N
22	SW4403	Key, Force USB boot button
23	SW4401	Key, Volume up button
24	SW4402	Key, Volume down button
25	SW4400	Key, Power on button
26	<ul style="list-style-type: none"> • LED4406 • LED4407 • LED4411 	3 x RGB LED from PMIC with independent brightness control: <ul style="list-style-type: none"> • LED4406, red LED • LED4407, green LED • LED4411, blue LED
18	<ul style="list-style-type: none"> • LED4400 • LED4402 • LED4404 	3 x RGB LED from GPIO, for example, BT/Wi-Fi activity: <ul style="list-style-type: none"> • LED4400, red LED, no use • LED4402, green LED, indicating Wi-Fi status • LED4404, blue LED, indicating BT status
27	<ul style="list-style-type: none"> • J1100 • J1101 • J1102 • J1103 	<ul style="list-style-type: none"> • Low-speed connector to low-speed expansion board • 4 x 80-pin B2B connector
28	LED4401	LED4401, indicating Main Board 4V2 OK
	LED4403	LED4403, indicating SOM power input OK
29	J3500	90-pin B2B connector, for camera interface extension such as HDMI in function and so on (with HDMI in)
30	J3600	LCD0 interface
31	J5000	90-pin B2B connector, for display interface extension such as LVDs, 4k LCM
40	<ul style="list-style-type: none"> • SW1300 • SW1301 • SW2100 • SW2101 • SW2200 	DIP switches for board function control

^{a)} Only HS 2.0 signal is available on CM6125 SOM.

^{b)} CM6125 USB0 is a complete Type-C port. By default, USB3900 is not used.

^{c)} CM6125 has only one group of DSI0, and thus all LCD1 interfaces are unavailable.

^{d)} Unavailable on CM6125.

1.1.2. Interposer Board overview



Figure 1-5. Interposer Board Overview

Table 1-3. Interposer Board interface list

Item	Reference	Description
1	J1600	ANT_2G_5G_WLAN, Wi-Fi 2.4G/5G&BT
2	J1400 ^{a)}	Camera module connector, CSI4
3	J1602	ANT_DRX, 2G+3G+4G RF Diversity RX
4	J1606	ANT_GPS_L1_IN, GPS, GLONASS, BeiDou, Galileo, QZSS, SBAS
5	J1000	CM6125 SOM
6	J1604	ANT_PRI, 2G+3G+4G Primary RX and TX

^{a)} This connector is reserved for internal CSI signal test only, and is thus unavailable to users.

1.1.3. Audio Board overview

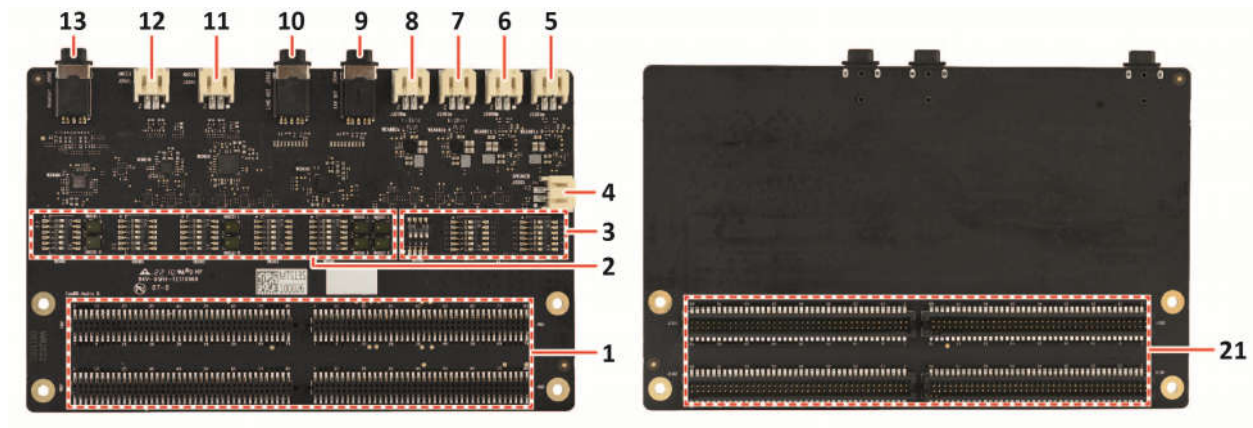

Figure 1-6. Audio Board Overview

Table 1-4. Audio Board interface list

Item	Reference	Description
1	J900 J901 J902 J903	<ul style="list-style-type: none"> • Low-speed connector to low-speed expansion board • 4 x 80-pin B2B connector
2	SW3400 SW3401 SW3402 SW3403 SW3404	DIP switch for DMIC connection selection
3	SW3100 SW3101 SW3102	DIP switch to control Audio Board configuration
4	J3505	Speaker connector
5	J3301M ^{a)}	Right WSA881x speaker connector
6	J3300M ^{a)}	Left WSA881x speaker connector
7	J3201M ^{a)}	Right WSA883x speaker connector
8	J3200M ^{a)}	Left WSA883x speaker connector
9	J3504	Ear out connector
10	J3503	Line out connector
11	J3500	Analog microphone connector 1
12	J3501	Analog microphone connector 3
13	J3502	Headset connector
21	J1000 J1100 J1101 J1102	<ul style="list-style-type: none"> • Low-speed connector to Main Board • 4 x 80-pin B2B connector

^{a)} CM6125 uses WSA8835 as the speaker amplifier, and thus J3201M and J3200M are available for CM6125 speaker connection.

1.1.4. Sensor Board overview

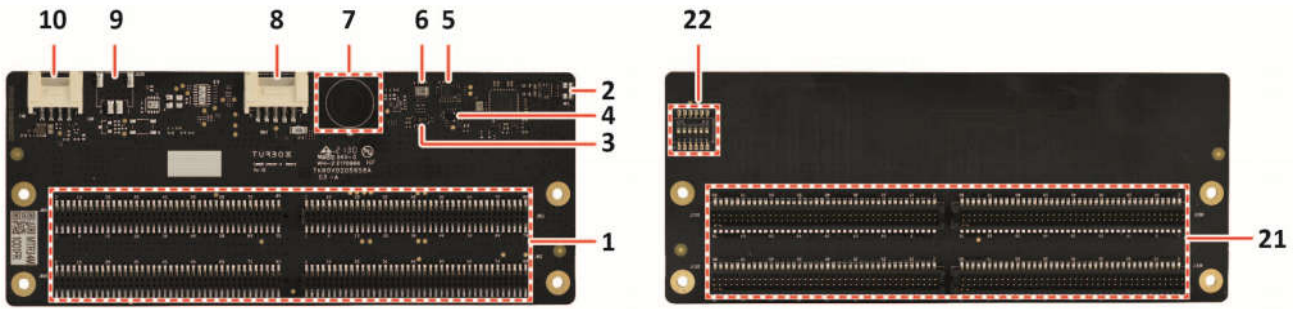

Figure 1-7. Sensor Board Overview

Table 1-5. Sensor Board interface list

Item	Reference	Description
1	J900 J901 J902 J903	<ul style="list-style-type: none"> • Low-speed connector to low-speed expansion board • 4 x 80-pin B2B connector
2	J4102 J4103	NFC antenna connector
3	U3103	ALS+ PROXIMITY sensor, TMD2755
4	U3100	Magnetic, SK09915C
5	U3101	ACC+GYRO sensor, LSM6DS3TR-C
6	U3102	Pressure sensor, BMP280
7	U3104	SAR sensor
8	J1001 ^{a)}	Battery connector
9	J4200 ^{b)}	CAN connector
10	J1500	FAN connector
21	J1000 J1100 J1101 J1102	<ul style="list-style-type: none"> • Low-speed connector to Main Board • 4 x 80-pin B2B connector
22	SW1100	DIP switch

^{a)} CM6125 DK uses DCDC to supply CM6125 SOM by default. To use battery as the supply source, please refer to Main Board circuit and rework the related resistors.

^{b)} Unavailable on CM6125 SOM.

1.4. DIP switches

1.4.1. DIP switches on Main Board

- SW1300 and SW1301 (for function configuration)

Table 1-6. State description of SW1300

No.	Name	Function	default
1	CSI0_HDMI_SEL	Control CSI0 switch for CAM0 or Camera Expansion Board <ul style="list-style-type: none"> • OFF: Use CAM0 on Main Board • ON: Use Camera Expansion Board 	OFF
2	CSI1_HDMI_SEL	Control CSI1 switch for CAM1 or Camera Expansion Board <ul style="list-style-type: none"> • OFF-use CAM1 on Main Board • ON -use Camera Expansion Board 	OFF
3	-	-	OFF
4	NFC_GPIO_SEL	Control GPIO switch for NFC function or PCIE Expansion Board <ul style="list-style-type: none"> • OFF-connect NFC related GPIO to NFC IC • ON - connect NFC related GPIO to pcie board for control 	OFF
5	-	-	OFF
6	HS_SW_TYPEC_MICROUSB	Control USB0 HS switch for Type C or Micro USB <ul style="list-style-type: none"> • OFF-use Type-C port • ON -use Micro USB port 	OFF

Table 1-7. State description of SW1301

No.	Name	Function	Default
1	DSI0_HDMI_SEL	Control DSI0 switch for LCD0 on board or HDMI OUT <ul style="list-style-type: none"> • OFF-use LCD0 on Main Board • ON –use HDMI OUT as display 	OFF
2	DSI0_HDMI_EXT_SEL	Control DSI0 switch for HDMI OUT or Display Expansion Board <ul style="list-style-type: none"> • OFF- use HDMI OUT as display • ON –use Display Expansion Board 	OFF
3	DSI1_HDMI_SEL	Control DSI1 switch for LCD1 on board or HDMI OUT <ul style="list-style-type: none"> • OFF-use LCD1 on Main Board • ON –use HDMI OUT as display 	OFF
4	DSI1_HDMI_EXT_SEL	Control DSI1 switch for HDMI OUT or Display Expansion Board <ul style="list-style-type: none"> • OFF- use HDMI OUT as display • ON –use Display Expansion Board 	OFF
5	LCD0_PWR_SEL_BL	Select LCD0 backlight source, supplied by SOM or DK <ul style="list-style-type: none"> • OFF-select SOM backlight for LCD0 • ON –select DK backlight generator for LCD0 	ON
6	LCD0_PWR_SEL_DISP	Select LCD0 BIAS source, supplied by SOM or DK <ul style="list-style-type: none"> • OFF-select SOM bias for LCD0 • ON –select DK bias generator for LCD0 	ON

• **SW2200 (for display function configuration)**

No.	Name	Function	Default
1	PM_PWM_A_LS	Connect PM_PWM_A to low speed interface as GPIO <ul style="list-style-type: none"> • OFF - / • ON –connect this signal to low speed con 	OFF
2	LCD0_BL_PWM_T	Connect PM_PWM_A to LCD0 for dimming backlight <ul style="list-style-type: none"> • OFF- / • ON – LCD0 backlight dimming 	ON
3	CON_GPIO_A9_LS	Connect CON_GPIO_A9 to low speed interface as GPIO <ul style="list-style-type: none"> • OFF- / • ON –connect this signal to low speed con 	OFF
4	LCD0_TE_T	Connect CON_GPIO_A9 to LCD0 for TE <ul style="list-style-type: none"> • OFF- / • ON –LCD0 use TE signal 	OFF
5	CON_GPIO_A10_LS	Connect CON_GPIO_A10 to low speed interface as GPIO <ul style="list-style-type: none"> • OFF- / • ON –connect this signal to low speed con 	OFF
6	LCD1_TE_T	Connect CON_GPIO_A10 to LCD1 for TE <ul style="list-style-type: none"> • OFF- / • ON –LCD1 use TE signal 	OFF

• **SW2100 and SW2101 (for camera function configuration)**

Table 1-8. State description of SW2100

No.	Name	Function	Default
1	CAM0_STROBE_LS	Connect CAM0_STROBE to low speed interface as GPIO <ul style="list-style-type: none"> • OFF- / • ON –connect this signal to low speed con 	OFF
2	CAM0_STROBE_CON	Connect CAM0_STROBE to CAM0 for strobe <ul style="list-style-type: none"> • OFF- / • ON –CAM0 uses flash strobe 	OFF
3	CAM0_DOVDD_1V8_EN_LS	Connect CAM0_DOVDD_1V8_EN to low speed interface as GPIO <ul style="list-style-type: none"> • OFF- / • ON –connect this signal to low speed con 	OFF
4	CAM0_DOVDD_1V8_EN_CON	Connect CAM0_DOVDD_1V8_EN to CAM0 for power control <ul style="list-style-type: none"> • OFF- / • ON –CAM0 power-on control 	ON
5	SLEEP_CLK_LS	Connect SLEEP_CLK to low speed interface for other function <ul style="list-style-type: none"> • OFF- / • ON –connect this signal to low speed con 	OFF
6	SLEEP_CLK_CON	Connect SLEEP_CLK to CAM0 for low power mode <ul style="list-style-type: none"> • OFF- / • ON –CAM0 uses sleep clock for low power mode 	OFF

Table 1-9. State description of SW2101

No.	Name	Function	Default
1	/		OFF
2	/		OFF
3	CAM1_SPI_CS_LS	Connect CAM1_SPI_CS to low speed interface as GPIO <ul style="list-style-type: none"> • OFF- / • ON –connect this signal to low speed con 	OFF
4	CAM1_SPI_CS_CON	Connect CAM1_SPI_CS to CAM1 for SPI communication <ul style="list-style-type: none"> • OFF- / • ON –CAM1 use SPI as communication interface 	OFF
5	CAM0_SPI_CS_LS	Connect CAM0_SPI_CS to low speed interface as GPIO <ul style="list-style-type: none"> • OFF- / • ON –connect this signal to low speed con 	OFF
6	CAM0_SPI_CS_CON	Connect CAM0_SPI_CS to LCD1 for SPI communication <ul style="list-style-type: none"> • OFF- / • ON –CAM1 use SPI as communication interface 	OFF

1.4.2. DIP switches on Audio Board

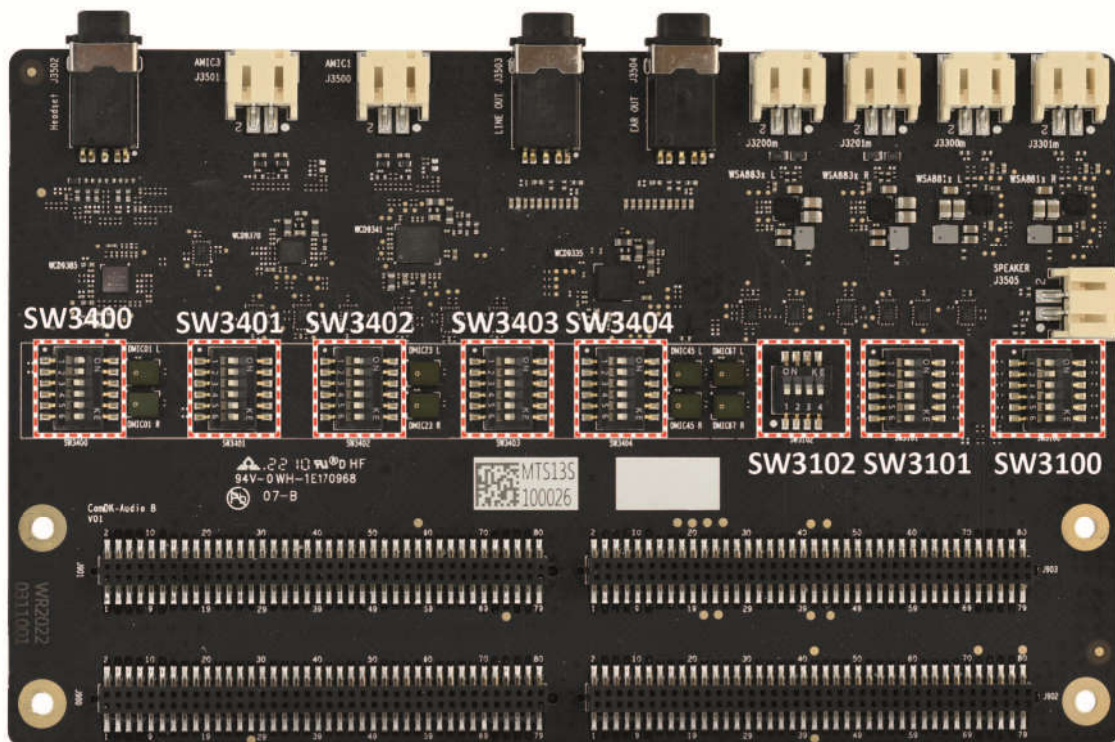

Figure 1-8. DIP Switches on Audio Board

By default, these DIP switches are set per the sequence of pin#1~pin#6.

- Board function settings:
 - SW3101: OFF/OFF/OFF/ON/OFF/ON, enabling WCD9385 and WSA8835
 - SW3100: OFF/OFF/OFF/OFF/OFF/OFF
 - SW3102: OFF/OFF/OFF/OFF/OFF/OFF

- DMIC connection settings:
 - SW3400: ON/ON/OFF/OFF/OFF/OFF, connecting SOM DMIC01
 - SW3401: OFF/OFF/OFF/OFF/ON/ON, connecting SOM DMIC23
 - SW3403: OFF/OFF/ON/ON/OFF/OFF, connecting SOM DMIC45
 - SW3402 & SW3404: OFF/OFF/OFF/OFF/OFF/OFF

Chapter 2. Specifications for CM6125 DK

2.1. Main Board

2.1.1. Power-on

Step 1. Connect the device (via the **UART debug port**, No. 2 in [Figure 1-4](#)) to a PC with a Micro USB cable.

Step 2. Run the serial console tool on host PC (for example: **minicom**).

🔄 **NOTE:**

- Set the Bps/Par/Bits to 115200 8N1
- If the UART log is not required, skip Steps 1 and 2.

Step 3. Connect the power adapter to the board.

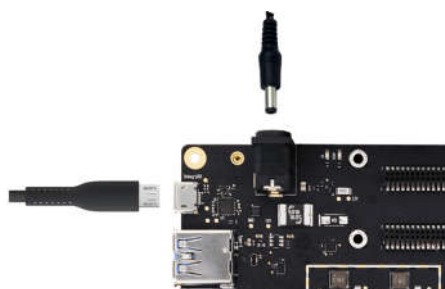

Figure 2-1. Connect Power Adapter

Step 4. Press and hold the **power on** button (No. 25 in [Figure 1-4](#)) for at least six seconds.

Afterwards, the board will start the bootup process.

2.1.2. Camera interface

Camera interfaces: No.8 to No.13 in [Figure 1-4](#).

There are 6 x 4L camera BTB (Board to Board) interfaces on the Main Board. Also, there is a 90-pin connector to expand camera or HDMI in interface on the camera module (see [Figure 1-2. Main Board Block Diagram](#)).

CM6125 SOM supports five integrated MIPI CSIs.

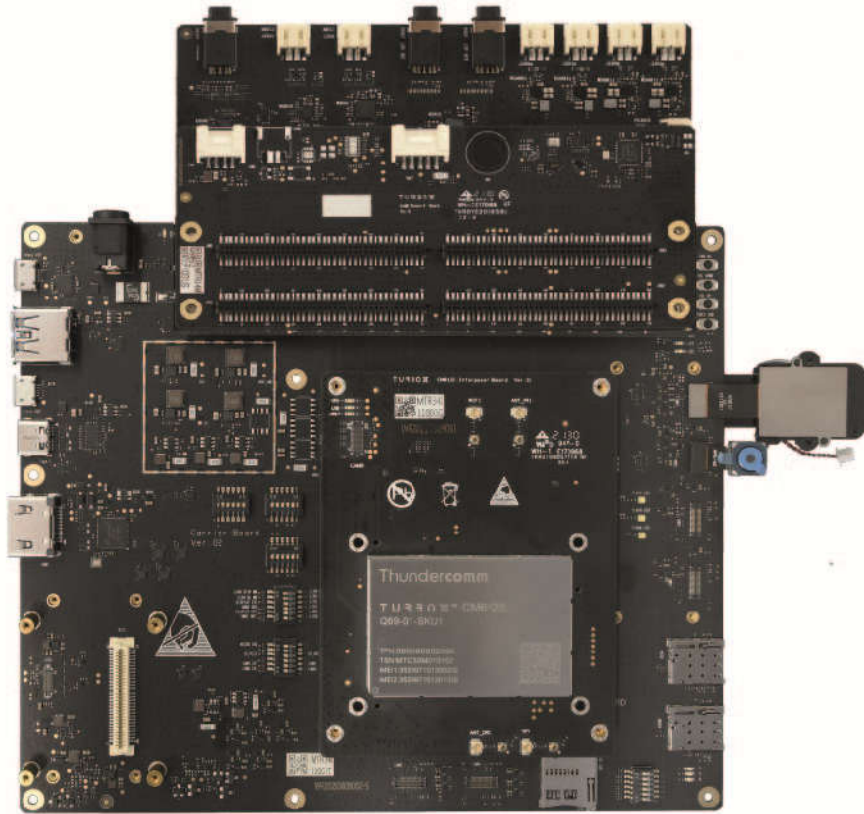

Figure 2-2. Camera Interfaces

All camera interfaces have the same pin definition (refer to [Table 3-1](#)) and all camera modules need dedicated FPC to enable connection to the interface. In other words, the camera interface is not directly adaptive to any camera.

Table 3-1. Camera interface description

No.	Name	Description
1	STROBE	Camera strobe for flash driver (FLASH_STROBE), only for CAM0
2	SPI_CLK	Reserved for Camera SPI communication interface, only for CAM0
3	AVDD_2V8	-
4	SPI_MOSI	Reserved for Camera SPI communication interface, only for CAM0
5	RST	-
6	GND	-
7	CSI_C1_LN2_P	-
8	CSI_A2_LN2_M	-
9	GND	-
10	CSI_B0_LN0_P	-
11	CSI_C0_LN0_M	-
12	GND	-
13	CSI_B2_LN3_P	-
14	CSI_C2_LN3_M	-
15	PWR_SWITCH ^{a)}	Used for DVDD power selection.
16	GND	-
17	CSI_B1_LN1_M	-
18	CSI_A1_LN1_P	-
19	GND	-
20	CSI_A0_CLK_M	-
21	CSI_NC_CLK_P	-
22	GND	-
23	MCLK	-
24	GND	-
25	I2C_SCL	-
26	I2C_SDA	-
27	SPI_CS ^{b)}	Reserved for Camera SPI communication interface, only for CAM0; Share with AFVDD (Auto Focus VDD), 5V, only for CAM0 and CAM1.
28	DOVDD	1.8V
29	SPI_MISO	Reserved for Camera SPI communication interface, only for CAM0
30	DVDD_1V1_1V2	Camera DVDD supports 1.1V and 1.2V selection.

NOTE:

^{a)} When the DVDD of camera module is 1.1V, the PIN-15 of FPC should be pulled up to DOVDD, then PIN-30 DVDD will output 1.1V for Camera; otherwise, PIN-30 outputs 1.2V for Camera by default.

^{b)} On CAM0 and CAM1, the interface adds AFVDD power supply, which shares with SPI_CS PIN-27. The voltage of AFVDD is 5V.

2.1.3. Display interface

- LCD0: No.30 in [Figure 1-4](#)
- HDMI out interface: No.5 in [Figure 1-4](#)

2.1.3.1. LCM

The LCM on the Main Board is connected to 5-inch 1280*720 TFT-LCD with touch panel, fixed by a dedicated holder.

Check the connection between the LCD panel (accessory) and the board, refer to Figure 2-3.

For detailed information on how to open LCM, refer to the relevant software user manual.

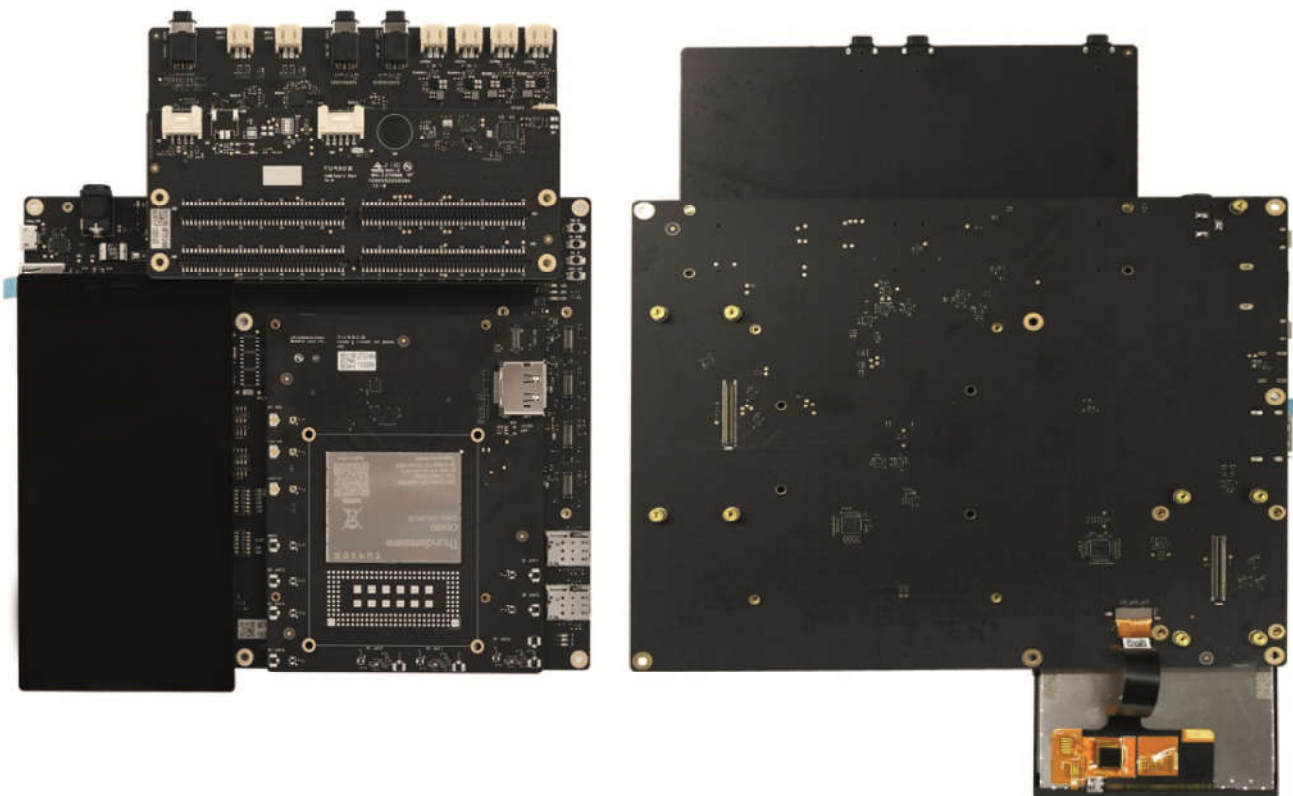

Figure 2-3. Display Panel Connection

Table 3-2. LCM pin definition

No.	Symbol	Description
1	LED-	Backlight cathode
2	LED+	Backlight anode
3	GND	Ground
4	TP-SDA	IIC signal of TP
5	TP-SCL	
6	TP-INT	INT signal of TP
7	TP-RST	Reset signal of TP
8	TP-VDD(2.8V)	Power supply 2.8V for TP
9	LCD-ID1	NC
10	AVDD5.5V	Power supply of 5.5V
11	AVEE-5.5V	Power supply of -5.5V
12	VDD1.8V	Power supply 1.8V for LCD
13	LCM-RSTN	Reset Singal for LCD
14	N25530738(PWM)	LCD backlight control PWM output Pin
15	LCM-FMARK(TE)	Tearing effect output pin
16	GND	Ground
17	MIPI_D0P	MIPI DSI Data0+ signal
18	MIPI_D0N	MIPI DSI Data0- signal
19	GND	Ground
20	MIPI_D1P	MIPI DSI Data1+ signal
21	MIPI_D1N	MIPI DSI Data1- signal
22	GND	Ground
23	MIPI_CLKP	MIPI DSI CLK+ signal
24	MIPI_CLKN	MIPI DSI CLK- signal
25	GND	Ground
26	MIPI_D2P	MIPI DSI Data2+ signal
27	MIPI_D2N	MIPI DSI Data2- signal
28	GND	Ground
29	MIPI_D3P	MIPI DSI Data3+ signal
30	MIPI_D3N	MIPI DSI Data3- signal

2.1.3.2. HDMI out

There is one HDMI out interface on the Main Board.

A DSI to HDMI Bridge (LONTIUM SEMICONDUCTOR LT9611UXC) performs this task and supports a resolution from 1080P to 4K at 60Hz.

This bridge also supports the audio function performed by a 1-bit I2S on SOMs.

For detailed information on how to open HDMI out, refer to the relevant software user manual.

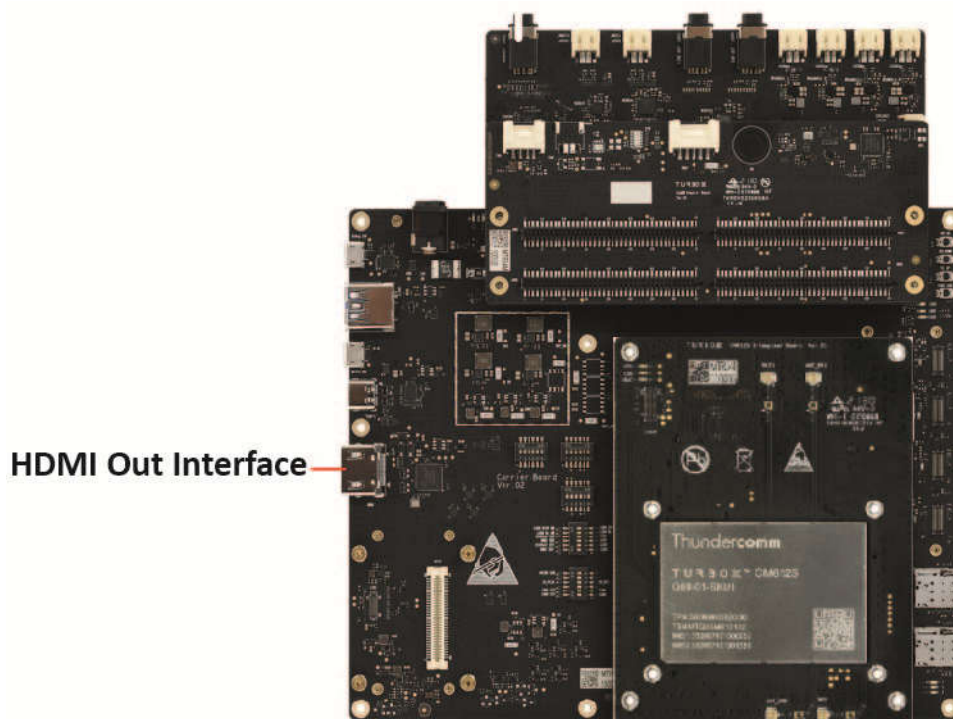

Figure 2-4. HDMI Out Interface

2.1.4. USB ports

The Main Board includes three USB ports:

- USB Type C
- Micro USB
- USB 3.0 Type A

🔔 **NOTE:** CM6125 does not use Micro USB by default.

2.1.5. Type-C port

The Main Board can implement a USB Type-C port (USB3900), No. 4 in [Figure 1-4](#).



Figure 2-5. USB Type-C Port Connection

This integrated Type-C port is connected to CM6125 USB0. It supports **adb** and firmware upgrade, as well as charger, DRD, DP.

➡ **NOTE:** Make sure to toggle SW6 of SW1300 to OFF and connect USB0 DP/DM to Type-C port.

2.1.6. USB Type-A port

The Main Board can implement a USB Type-A port (J3900), No. 3 in [Figure 1-4](#), which supports only the device mode.



Figure 2-6. USB Type-A Port Connection

This port is connected to CM6125 USB1, which only supports USB2.0. So J3900 does not support USB3.0 on CM6125 SOM.

2.1.7. SD card slot

The Main Board supports one Micro SD slot.

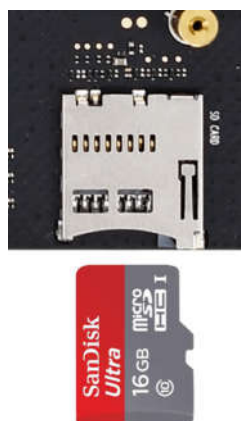

Figure 2-7.SD Card Slot

2.1.8. Buttons

Four buttons are available on the Main Board.

- SW4400: **power on button**, (No. 25 in [Figure 1-4](#)), serves as the Power ON/OFF/Sleep button. You can press and hold the button for more than 3 seconds to power on the device.
- SW4401: **volume up button** (No. 23 in [Figure 1-4](#))
- SW4402: **volume down button** (No. 24 in [Figure 1-4](#))
- SW4403: **force USB boot button** (No. 22 in [Figure 1-4](#)), used for emergency USB boot-up during product development.



Figure 2-8.Buttons

2.1.9. LED

Ten LEDs are available on the Main Board.

- Two green LEDs (LED4401/LED4403), (No. 28 in [Figure 1-4](#)), as power indicators;
 - LED4401 indicates that the Main Board functions well.
 - LED4403 indicates that the SOM functions well with 4.2 V power supply.
- Three RGB LEDs (LED4406/LED4407/LED4411) from PMIC with independent brightness control;
- Three RGB LEDs (LED4400/LED4402/LED4404) from GPIO, for example, BT/Wi-Fi activity;
- Two flashing LEDs (LED4409/LED4410) as camera flash indicators.

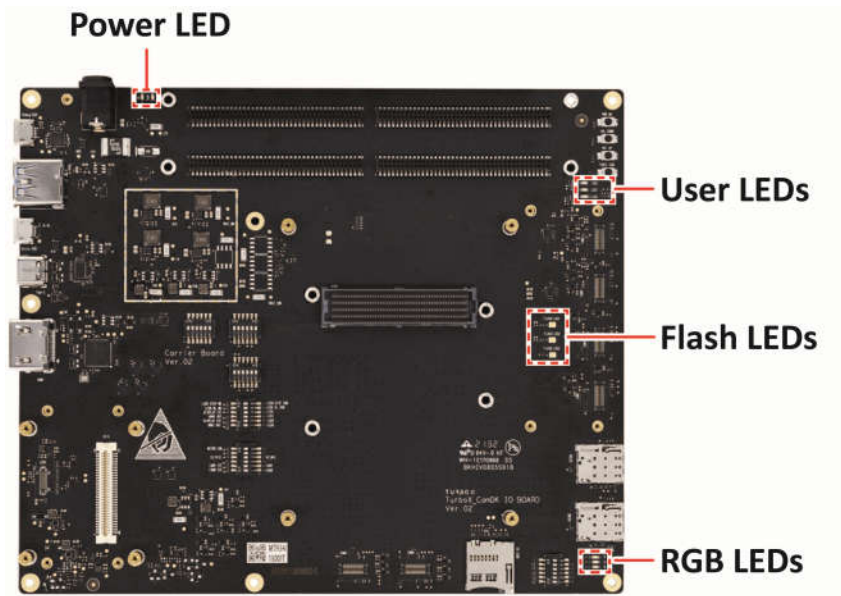

Figure 2-9. Locate LEDs

2.1.10. Boot config switch

A 6-pin DIP (Double In-line Package) switch (No. 21 in [Figure 1-4](#)) is located at the top of the Main IO Board.

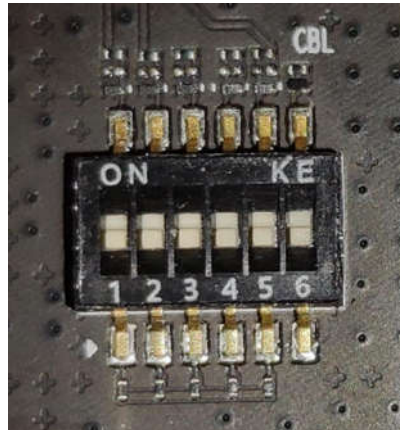

Figure 2-10. Boot Config Switch

- Pin#1, 2, 3, and 4 are used for boot configuration.
 - Pin#1: BOOT_CONFIG(0), WDOG_DISABLE (ON: disable WDOG; OFF: enable WDOG)
 - Pin#2: BOOT_CONFIG(1), FAST_BOOT_0
 - Pin#3: BOOT_CONFIG(2), FAST_BOOT_1
 - Pin#4: BOOT_CONFIG(3), FAST_BOOT_2

➤ **NOTE:** Pin#2/3/4 can define the device bootup sequence of the SOM. Refer to Figure 3-8.

Table 3-3. Device bootup sequence of SOM (example)

FAST_BOOT GPIO [2:0]	Boot device
000	Default: eMMC → uSD → USB → eDL(USB)
001	uSD → eMMC → USB(eDL)
010	SDC2 → USB(eDL)
011	USB(eDL)
100	UFS → uSD → USB(eDL)
101	uSD → UFS → USB(eDL)
110	UFS → USB(eDL)
111	UFS_PWM_MODE → USB(eDL)
Others	Reserved

- Pin#5: BOOT_CONFIG(4), reserved.
- Pin#6 serves as CBL_PWR_N.

2.1.11. Camera expansion connector

No. 29 in [Figure 1-4](#)

This connector is used to expand the camera board, including camera module and HDMI in.

For more information on the camera expansion connector pin-outs, refer to Table 6-1.

Table 3-4. Camera expansion connector pin-outs

Name	No.	No.	Name
GND	1	2	GND
CAM0_SDA_EXT	3	4	CSI0_B0_LN0_P_HS
CAM0_SCL_EXT	5	6	CSI0_C0_LN0_M_HS
GND	7	8	GND
CAM0_AVDD_2V8_EN_EXT	9	10	CSI0_A1_LN1_P_HS
CAM0_DVDD_1V2_EN_EXT	11	12	CSI0_B1_LN1_M_HS
CAM0_RST_EXT	13	14	GND
CAM0_XVS_EXT	15	16	CSI0_NC_CLK_P_HS
CAM0_XHS_EXT	17	18	CSI0_A0_CLK_M_HS
CAM_SPI_CS_EXT	19	20	GND
CAM_SPI_MOSI_EXT	21	22	CSI0_C1_LN2_P_HS
CAM_SPI_MISO_EXT	23	24	CSI0_A2_LN2_M_HS
I2S_CLK_HDMI_IN	25	26	GND
I2S_MCLK_HDMI_IN	27	28	CSI0_B2_LN3_P_HS
I2S_WS_HDMI_IN	29	30	CSI0_C2_LN3_M_HS
I2S_DO_HDMI_IN	31	32	GND
GND	33	34	CAM0_MCLK_EXT
VDC_1V8	35	36	NC
VDC_1V8	37	38	NC
GND	39	40	CAM_SPI_CLK_EXT
VDC_1V8	41	42	VDC_3V3
VDC_1V8	43	44	VDC_3V3
GND	45	46	GND
VDC_3V3	47	48	VDC_1V8
VDC_3V3	49	50	VDC_1V8
GND	51	52	NC
VDC_5V	53	54	CAM1_MCLK_EXT
VDC_5V	55	56	FLASH_LED1_EXT
GND	57	58	FLASH_LED2_EXT
HDMI_IN_I2C_SCL	59	60	GND
HDMI_IN_I2C_SDA	61	62	CSI1_C2_LN3_M_HS
HDMI_IN_RSTN_EXT	63	64	CSI1_B2_LN3_P_HS
HDMI_IN_INT_EXT	65	66	GND

Name	No.	No.	Name
UART_RTS_EXT	67	68	CSI1_A2_LN2_M_HS
UART_RXD_EXT	69	70	CSI1_C1_LN2_P_HS
UART_TXD_EXT	71	72	GND
CAM1_XHS_EXT	73	74	CSI1_A0_CLK_M_HS
CAM1_XVS_EXT	75	76	CSI1_NC_CLK_P_HS
CAM1_RST_EXT	77	78	GND
CAM1_DVDD_1V2_EN_EXT	79	80	CSI1_B1_LN1_M_HS
CAM1_AVDD_2V8_EN_EXT	81	82	CSI1_A1_LN1_P_HS
GND	83	84	GND
CAM1_SCL_EXT	85	86	CSI1_C0_LN0_M_HS
CAM1_SDA_EXT	87	88	CSI1_B0_LN0_P_HS
GND	89	90	GND

2.1.12. Display expansion connector

This connector is used to expand the display board.

For more information on the camera expansion connector pin-outs, refer to Table 3-4.

Table 3-5. Display expansion connector pin-outs

Name	No.	No.	Name
GND	1	2	GND
TP0_SDA_EXT	3	4	DSIO_A0_LN0_P_EXT
TP0_SCL_EXT	5	6	DSIO_B0_LN0_M_EXT
GND	7	8	GND
LCD0_VDD_2V8_EN_EXT	9	10	DSIO_C0_LN1_P_EXT
LCD0_VDD_1V8_EN_EXT	11	12	DSIO_A1_LN1_M_EXT
TP0_RST_EXT	13	14	GND
TP0_INT_EXT	15	16	DSIO_B1_CLK_P_EXT
LCD0_TE_EXT	17	18	DSIO_C1_CLK_M_EXT
LCD0_RESET_N_EXT	19	20	GND
LCD0_BL_EN_EXT	21	22	DSIO_A2_LN2_P_EXT
LCD0_VSP_EN_EXT	23	24	DSIO_B2_LN2_M_EXT
I2S_CLK_HDMI_OUT_EXT	25	26	GND
I2S_MCLK_HDMI_OUT_EXT	27	28	DSIO_C2_LN3_P_EXT
I2S_WS_HDMI_OUT_IN_EXT	29	30	DSIO_NC_LN3_M_EXT
I2S_D0_HDMI_OUT_EXT	31	32	GND
GND	33	34	LCD0_BL_PWM_EXT
N529916	35	36	HDMI_OUT_PWREN_EXT
N529916	37	38	HDMI_OUT_PWREN_1P2_EXT
GND	39	40	LCD0_VSN_EN_EXT

Name	No.	No.	Name
VDC_1V8	41	42	VDC_3V3
VDC_1V8	43	44	VDC_3V3
GND	45	46	GND
VDC_3V3	47	48	VDC_1V8
VDC_3V3	49	50	VDC_1V8
GND	51	52	LCD1_VSN_EN_EXT
VDC_5V	53	54	LCD1_BL_PWM_EXT
VDC_5V	55	56	FLASH_LED1_EXT
GND	57	58	FLASH_LED2_EXT
HDMI_OUT_I2C_SCL_EXT	59	60	GND
HDMI_OUT_I2C_SDA_EXT	61	62	DSI1_NC_LN3_M_EXT
HDMI_OUT_RSTN_EXT	63	64	DSI1_C2_LN3_P_EXT
HDMI_OUT_INT_EXT	65	66	GND
LCD1_VSP_EN_EXT	67	68	DSI1_B2_LN2_M_EXT
LCD1_BL_EN_EXT	69	70	DSI1_A2_LN2_P_EXT
LCD1_RESET_N_EXT	71	72	GND
LCD1_TE_EXT	73	74	DSI1_C1_CLK_M_EXT
TP1_INT_EXT	75	76	DSI1_B1_CLK_P_EXT
TP1_RST_EXT	77	78	GND
LCD1_VDD_1V8_EN_EXT	79	80	DSI1_A1_LN1_M_EXT
LCD1_VDD_2V8_EN_EXT	81	82	DSI1_C0_LN1_P_EXT
GND	83	84	GND
TP1_SCL_EXT	85	86	DSI1_B0_LN0_M_EXT
TP1_SDA_EXT	87	88	DSI1_A0_LN0_P_EXT
GND	89	90	GND

2.1.13. PCIe expansion connector

NO. 7 in [Figure 1-4](#)

This connector is used to expand the PCIe board.

For pin-outs of the high-speed expansion connector, refer to Table 3-5.

Table 3-6. High-speed expansion connector pin-outs

Name	No.	No.	Name
PCIE1_REFCLK_M	1	2	PCIE2_REFCLK_M
PCIE1_REFCLK_P	3	4	PCIE2_REFCLK_P
GND	5	6	GND
PCIE1_RX0_M	7	8	PCIE2_RX0_M
PCIE1_RX0_P	9	10	PCIE2_RX0_P
GND	11	12	GND
PCIE1_TX0_M	13	14	PCIE2_RX1_M
PCIE1_TX0_P	15	16	PCIE2_RX1_P
GND	17	18	GND
PCIE1_RX1_M	19	20	PCIE2_TX0_M
PCIE1_RX1_P	21	22	PCIE2_TX0_P
GND	23	24	GND
PCIE1_TX1_M	25	26	PCIE2_TX1_M
PCIE1_TX1_P	27	28	PCIE2_TX1_P
GND	29	30	GND
PCIE1_CLK	31	32	PCIE2_CLK
GND	33	34	GND
PCIE1_RST	35	36	PCIE2_RST
PCIE1_WK	37	38	PCIE2_WK
GND	39	40	/
PCIE_CTL_1	41	42	PCIE_CTL_3
PCIE_CTL_2	43	44	/
SPI_CS_EXT	45	46	PCIE_CTL_3
SPI_CLK_EXT	47	48	GND
SPI_MOSI_EXT	49	50	SPI_MISO_EXT
GND	51	52	GND
VDC_1V8	53	54	VDC_1V8
VDC_3V3	55	56	VDC_3V3
VDC_3V3	57	58	VDC_3V3
VBAT_MB	59	60	VBAT_MB

2.2. Interposer Board

2.2.1. Wi-Fi/Bluetooth and GPS connection

- The SOM supports Wi-Fi/BT function via the **Wi-Fi antenna connector** (No.1 in [Figure 1-5](#)).



Figure 2-11. Wi-Fi/BT Antenna Connector

- The SOM supports GPS function via the GPS antenna connector (No.4 in [Figure 1-5](#)).

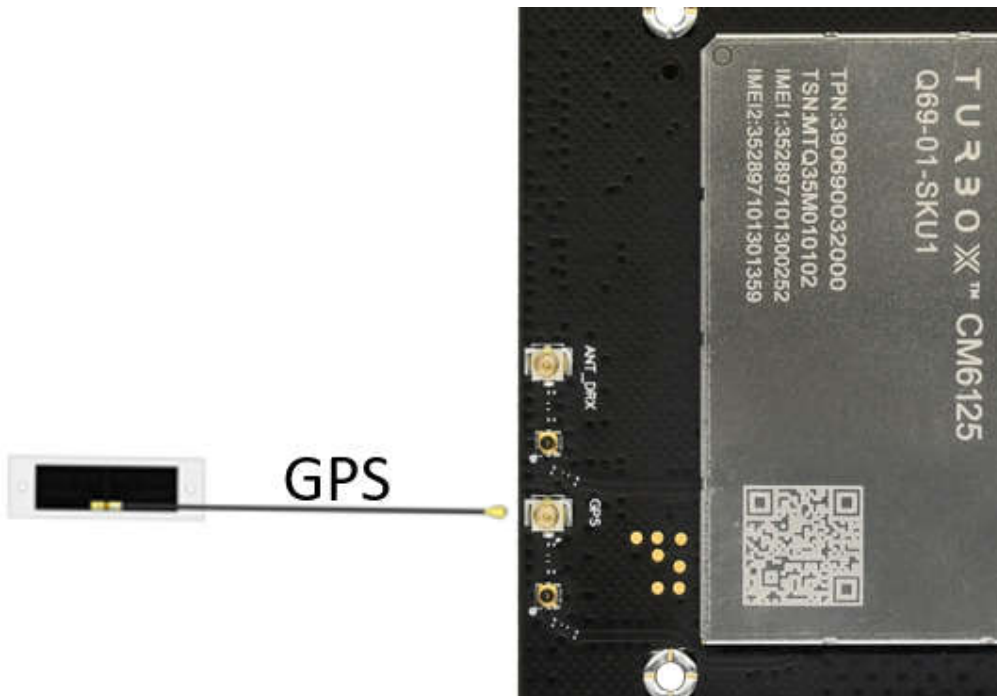

Figure 2-12. GPS Antenna Connector

2.2.2. 2G/3G/4G connection

The SOM supports 2G/3G/4G via the primary antenna connector (No.6 in [Figure 1-5](#)) and DRX antenna connector (No. 3 in [Figure 1-5](#)).

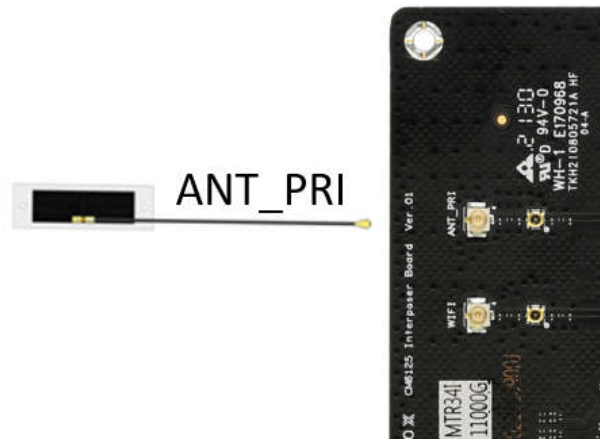

Figure 2-13. Primary Antenna Connector



Figure 2-14. DRX Antenna Connector

2.3. Audio Board

This section describes functions located on the Audio Board.

☞ **NOTE:** Make sure to set the DIP switches should be set to the right state (see [1.4.2. DIP switches on Audio Board](#)).

2.3.1. Speaker connector

CM6125 SOM supports dedicated SoundWire interface for smart speaker amplifier, WSA8835. The maximum output power is 7.3W into 8Ω for speaker.

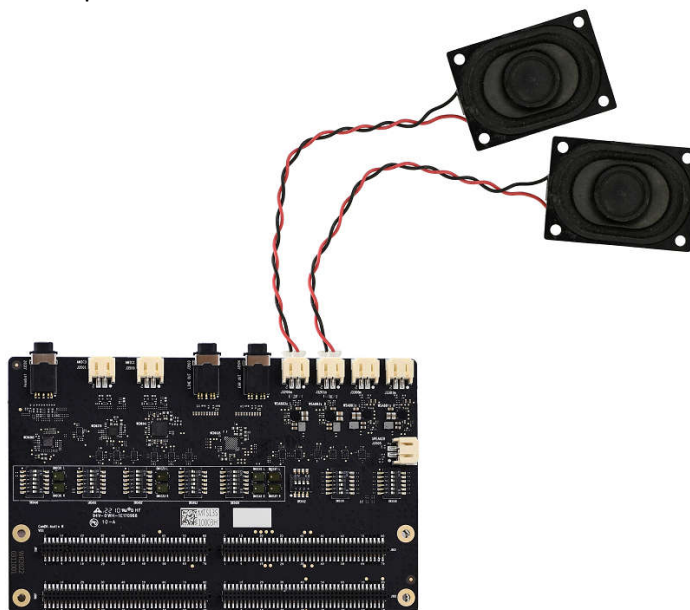

Figure 2-15. Speaker Connection

2.3.2. Headset connector

CM6125 SOM supports a headset interface form codec WCD9385. The headset supports microphone and is suitable CTIA standard.

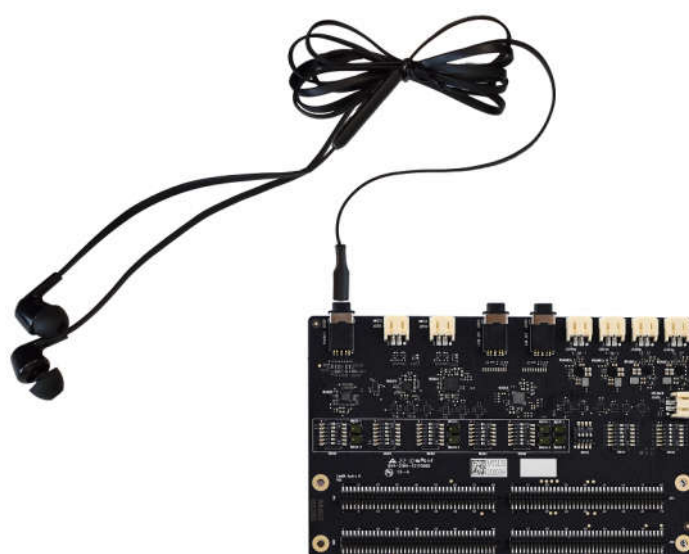

Figure 2-16. Headset Connection

2.3.3. DMIC

CM6125 SOM supports three DMIC arrays, connected to SoC.

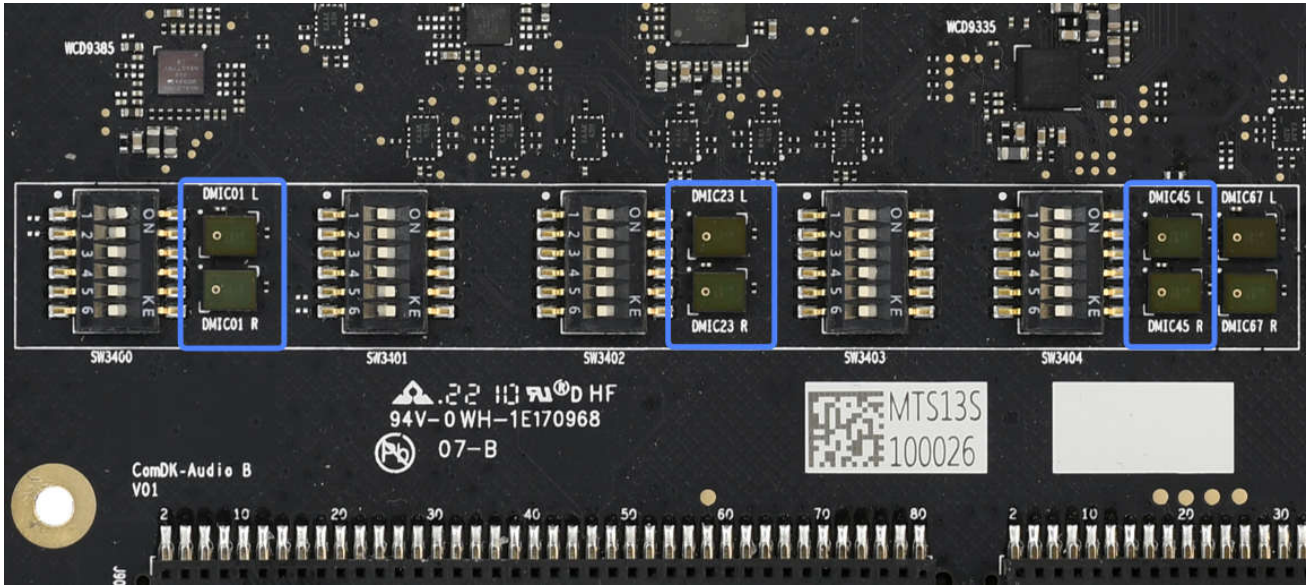

Figure 2-17. DMIC Arrays.

2.4. Sensor Board

2.4.1. Sensor

CM6125 SOM implements five-sensor IC. Refer to [Figure 1-7](#).

2.4.2. Battery connector

No. 8 in [Figure 1-7](#)

Table 3-7. Pin definition of battery connector

No.	Name	Description
1	VBAT_SOM	Battery positive
2		
3	BATT_ID	Battery missing detection
4	GND	Battery negative
5		

NOTE: CM6125 DK uses DCDC to supply CM6125 SOM by default. To use battery as the supply source, refer to relevant software user manual.

2.4.3. Fan connector

Step 1. Refer to Figure 3-11 to connect a fan to the board via the **fan connector** (No.10 in [Figure 1-5](#)).

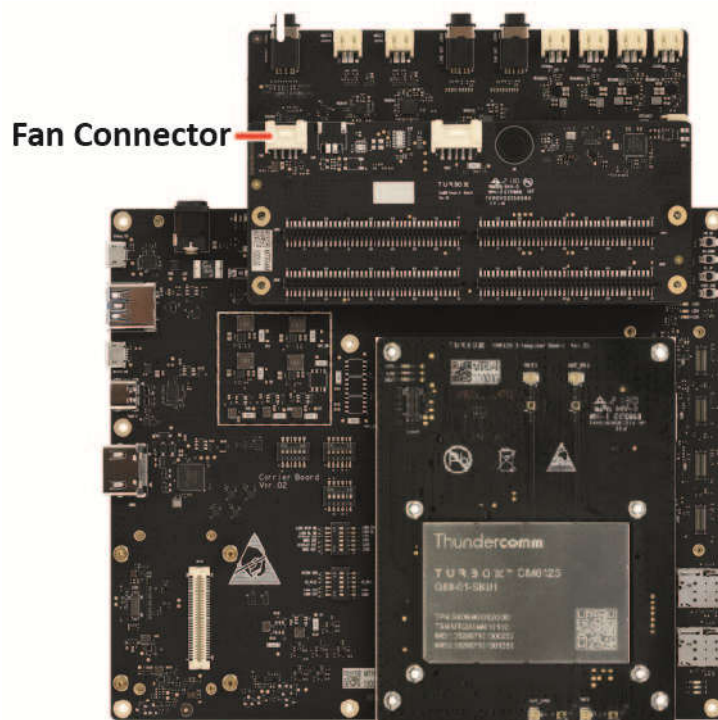

Figure 2-18. Fan Connector

Table 3-1. Fan function

No.	Function
1	PWM
2	NA
3	FAN_VCC, default 12V
4	GND

Appendix 1. Compliance and Certificate Information

FCC Statements:

OEM/Integrators Installation Manual

Important Notice to OEM integrators

1. This module is limited to OEM installation ONLY.
2. This module is limited to installation in mobile or fixed applications, according to Part 2.1091(b).
3. The separate approval is required for all other operating configurations, including portable configurations with respect to Part 2.1093 and different antenna configurations
4. For FCC Part 15.31 (h) and (k): The host manufacturer is responsible for additional testing to verify compliance as a composite system. When testing the host device for compliance with Part 15 Subpart B, the host manufacturer is required to show compliance with Part 15 Subpart B while the transmitter module(s) are installed and operating. The modules should be transmitting and the evaluation should confirm that the module's intentional emissions are compliant (i.e. fundamental and out of band emissions). The host manufacturer must verify that there are no additional unintentional emissions other than what is permitted in Part 15 Subpart B or emissions are complaint with the transmitter(s) rule(s).

The Grantee will provide guidance to the host manufacturer for Part 15 B requirements if needed.

Important Note

Notice that any deviation(s) from the defined parameters of the antenna trace, as described by the instructions, require that the host product manufacturer must notify to XXXX that they wish to change the antenna trace design. In this case, a Class II permissive change application is required to be filed by the USI, or the host manufacturer can take responsibility through the change in FCC ID (new application) procedure followed by a Class II permissive change application.

End Product Labeling

When the module is installed in the host device, the FCC label must be visible through a window on the final device or it must be visible when an access panel, door or cover is easily re-moved. If not, a second label must be placed on the outside of the final device that contains the following text: "Contains FCC ID: 2AOHHTURBOXCM6125"

The FCC ID can be used only when all FCC compliance requirements are met.

Antenna Installation

- (1) The antenna must be installed such that 20 cm is maintained between the antenna and users,
- (2) The transmitter module may not be co-located with any other transmitter or antenna.

(3) Only antennas of the same type and with equal or less gains as shown below may be used with this module. Other types of antennas and/or higher gain antennas may require additional authorization for operation.

Antenna type	BT&2.4GHz band Peak Gain (dBi)	5.2GHz band Peak Gain (dBi)	5.3GHz band Peak Gain (dBi)	5.5GHz band Peak Gain (dBi)	5.8GHz band Peak Gain (dBi)
Monopole	4	/	/	/	/
Dipole	/	3.1	3.2	3.2	3.1

WWAN antenna types and gain values:

Antenna type	Frequency Bands		Antenna Gain (dBi)
Monopole Antenna	UMTS Band(s)	FDD II	3
		FDD IV	4.5
		FDD V	1.2
	LTE Bands(s)	FDD 2	3
		FDD 4	4.5
		FDD 5	1.2
		FDD 7	4
		FDD 12	1.2
		FDD 13	1.2
		FDD 17	1.2
		FDD 25	3
		FDD 26	1.2
		TDD 41	4
		FDD 66	4.5
		FDD 71	2

In the event that these conditions cannot be met (for example certain laptop configurations or co-location with another transmitter), then the FCC/IC authorization is no longer considered valid and the FCC ID/IC ID cannot be used on the final product. In these circumstances, the OEM integrator will be responsible for re-evaluating the end product (including the transmitter) and obtaining a separate FCC/IC authorization.

Manual Information to the End User

The OEM integrator has to be aware not to provide information to the end user regarding how to install or remove this RF module in the user’s manual of the end product which integrates this module. The end user manual shall include all required regulatory information/warning as show in this manual.

Federal Communication Commission Interference Statement

This device complies with Part 15 of the FCC Rules. Operation is subject to the following two conditions: (1) This device may not cause harmful interference, and (2) this device must accept any interference received, including interference that may cause undesired operation.

This equipment has been tested and found to comply with the limits for a Class B digital device, pursuant to Part 15 of the FCC Rules. These limits are designed to provide reasonable protection against harmful interference in a residential installation. This equipment generates, uses and can radiate radio frequency energy and, if not installed and used in accordance with the instructions, may cause harmful interference to radio communications. However, there is no guarantee that interference will not occur in a particular installation. If this equipment does cause harmful interference to radio or television reception, which can be determined by turning the equipment off and on, the user is encouraged to try to correct the interference by one of the following measures:

- Reorient or relocate the receiving antenna.
- Increase the separation between the equipment and receiver.
- Connect the equipment into an outlet on a circuit different from that to which the receiver is connected.
- Consult the dealer or an experienced radio/TV technician for help.

Any changes or modifications not expressly approved by the party responsible for compliance could void the user's authority to operate this equipment. This transmitter must not be co-located or operating in conjunction with any other antenna or transmitter.

List of applicable FCC rules

This module has been tested and found to comply with 15.247 and 15.407 Part22/24/27/90 requirements for Modular Approval.

The modular transmitter is only FCC authorized for the specific rule parts (i.e., FCC transmitter rules) listed on the grant, and that the host product manufacturer is responsible for compliance to any other FCC rules that apply to the host not covered by the modular transmitter grant of certification. If the grantee markets their product as being Part 15 Subpart B compliant (when it also contains unintentional-radiator digital circuitry), then the grantee shall provide a notice stating that the final host product still requires Part 15 Subpart B compliance testing with the modular transmitter installed.

This device is intended only for OEM integrators under the following conditions: (For module device use)

- 1) The antenna must be installed such that 20 cm is maintained between the antenna and users, and
- 2) The transmitter module may not be co-located with any other transmitter or antenna.

As long as 2 conditions above are met, further transmitter test will not be required. However, the OEM integrator is still responsible for testing their end-product for any additional compliance requirements required with this module installed.

Radiation Exposure Statement

This equipment complies with FCC radiation exposure limits set forth for an uncontrolled environment. This equipment should be installed and operated with minimum distance 20 cm between the radiator & your body.

EU Regulatory Conformance

Hereby, Thundercomm Technology Co., Ltd declares that this device is in compliance with the essential requirements and other relevant provisions of Directive 2014/53/EU.



The device for operation in the band 5150–5350 MHz is only for indoor use to reduce the potential for harmful interference to co-channel mobile satellite systems.

	AT	BE	BG	HR	CY	CZ	DK
	EE	FI	FR	DE	EL	HU	IE
	IT	LV	LT	LU	MT	NL	PL
	PT	RO	SK	SI	ES	SE	CH
	IS	LI	NO	TR	UK(NI)		

The device could be used with a separation distance of 20 cm to the human body.

The device is operated with the following RF bands power in different operation modes:

Operating Mode	Operating Frequency Range		Maximum Transmit Power (EIRP) dBm
	TX(MHz)	RX(MHz)	
Bluetooth	2402 - 2480		
WLAN 2.4GHz	2412 - 2472		
WLAN 5GHz Band 1	5150 - 5250		
WLAN 5GHz Band 2	5250 - 5350		
WLAN 5GHz Band 3	5470 - 5725		
WLAN 5GHz Band 4	5725 - 5850		13.88

Frequency bands and maximum transmit power:

Frequency Bands		Conducted Power dBm
GSM Band(s)	E-GSM 900	33.5
	DCS 1800	30
UMTS Band(s)	FDD I	24
	FDD V	24
	FDD VIII	24
LTE Bands(s)	FDD 1	24
	FDD 3	24
	FDD 5	24
	FDD 7	24
	FDD 8	24
	FDD 20	24

Frequency Bands		Conducted Power dBm
	FDD 28	24
	TDD 34	24
	TDD 38	24
	TDD 40	24
	TDD 41	24

Appendix 2. Contact Information of EU Local Agency

Company: Thundercomm Europe GmbH
Address: 20, Oskar-von-Miller-Ring, 80333 München, c/o WeWork
Contact person: Daodong Zhang
E-mail: zhangdd0913@thundercomm.com

Appendix 3. Contact Information of US Local Agency

Company: Thundercomm America Corporation

Address: 10180 Telesis Court, Suite 120, San Diego, CA 92121

Contact person: Weiqin Bai

E-mail:

- weiqin.bai@thundercomm.com
- baiwq@thundersoft.com

Mobile:

- +1-8585315328
- +86-18618401680

Appendix 4. Notices

Thundercomm may have patents or pending patent programs covering subject matter described in this document. The furnishing of this document does not give you any license to these patents. You can send license inquiries to service@thundercomm.com.

THUNDERCOMM PROVIDES THIS PUBLICATION "AS IS" WITHOUT WARRANTY OF ANY KIND, EITHER EXPRESS OR IMPLIED, INCLUDING, BUT NOT LIMITED TO, THE IMPLIED WARRANTIES OF NON-INFRINGEMENT, MERCHANTABILITY OR FITNESS FOR A PARTICULAR PURPOSE. Some jurisdictions do not allow disclaimer of express or implied warranties in certain transactions; therefore, this statement may not apply to you.

Changes are made periodically to the information herein; these changes will be incorporated in new editions of the publication. To provide better service, Thundercomm reserves the right to improve and/or modify the products and software programs described in the manuals, and the content of the manual, at any time without additional notice.

The software interface and function and hardware configuration described in the manuals included with your development board or system on module might not match exactly the actual configuration of that you have purchased. For the configuration of the product, refer to the related contract (if any) or product packing list, or consult the distributor for the product sales. Thundercomm may use or distribute any of the information you supply in any way it believes appropriate without incurring any obligation to you.

The products described in this document are not intended for use in implantation or other life support applications where malfunction may result in injury or death to persons. The information contained in this document does not affect or change Thundercomm product specifications or warranties. Nothing in this document shall operate as an express or implied license or indemnity under the intellectual property rights of Thundercomm or third parties. All information contained in this document was obtained in specific environments and is presented as an illustration. The result obtained in other operating environments may vary.

The information of this document should not be as any invitation for offer or any advice to the visitors. Please consult the professional comments from the sales consultant prior to do any actions of investment or purchase.

Thundercomm may use or distribute any of the information you supply in any way it believes appropriate without incurring any obligation to you.

Any references in this publication to non-Thundercomm Web sites are provided for convenience only and do not in any manner serve as an endorsement of those Web sites. The materials at those Web sites are not part of the materials for this Thundercomm product, and use of those Web sites is at your own risk. Thundercomm shall not be responsible for the content of the third party.

Any performance data contained herein was determined in a controlled environment. Therefore, the result obtained in other operating environments may vary significantly. Some measurements may have been made on development-level systems and there is no guarantee that these measurements will be the same on generally available systems. Furthermore, some measurements may have been estimated through extrapolation. Actual results may vary. Users of this document should verify the applicable data for their specific environment.

This document is copyrighted by Thundercomm and the property right of the date mentioned in this document, including but not limited trademarks, patents, copyrights, trade name etc. are not covered by any open-source license. Thundercomm may update this document at any time without notice.

Anyone doesn't have the right to amend, reprint, republication, reproduce, transmit, distribute or any other way to use this document in business or public purpose without the prior written consent by Thundercomm.

E-mail messages sent to Thundercomm via the Internet are not guaranteed to be completely secure. Thundercomm shall not be liable for any loss incurred by the surfer when transmitting any information over the Internet or for any loss incurred by Thundercomm when sending any information over

the Internet at your request.

Thundercomm has all rights under other relevant exemptions provided by laws and regulations, and Thundercomm's failure to claim or delay in claiming such rights shall not be deemed to be a waiver of such rights by Thundercomm.

Thundercomm reserves the right of final interpretation of this document.

Appendix 5. Trademarks

Thundercomm, Thundercomm TurboX, TURBOX, Thundersoft turbox are trademarks of Thundercomm Corporation or its associate companies in China and/or other countries. Intel, Intel SpeedStep, Optane, and Thunderbolt are trademarks of Intel Corporation or its subsidiaries in the U.S. and/or other countries. Microsoft, Windows, Direct3D, BitLocker, and Cortana are trademarks of the Microsoft group of companies. Mini DisplayPort (mDP), DisplayPort, and VESA are trademarks of the Video Electronics Standards Association. The terms HDMI and HDMI High-Definition Multimedia Interface are trademarks or registered trademarks of HDMI Licensing LLC in the United States and other countries. Wi-Fi, Wi-Fi Alliance, WiGig, and Miracast are registered trademarks of Wi-Fi Alliance. USB-C is a registered trademark of USB Implementers Forum. All other trademarks are the property of their respective owners.

Antenna trace interpretation

- Trace of WIFI 2.4/5G,
The width is 0.3175mm and the length is 27.75mm. Impedance: 50ohm, keep out cooper of L2 under the trace.

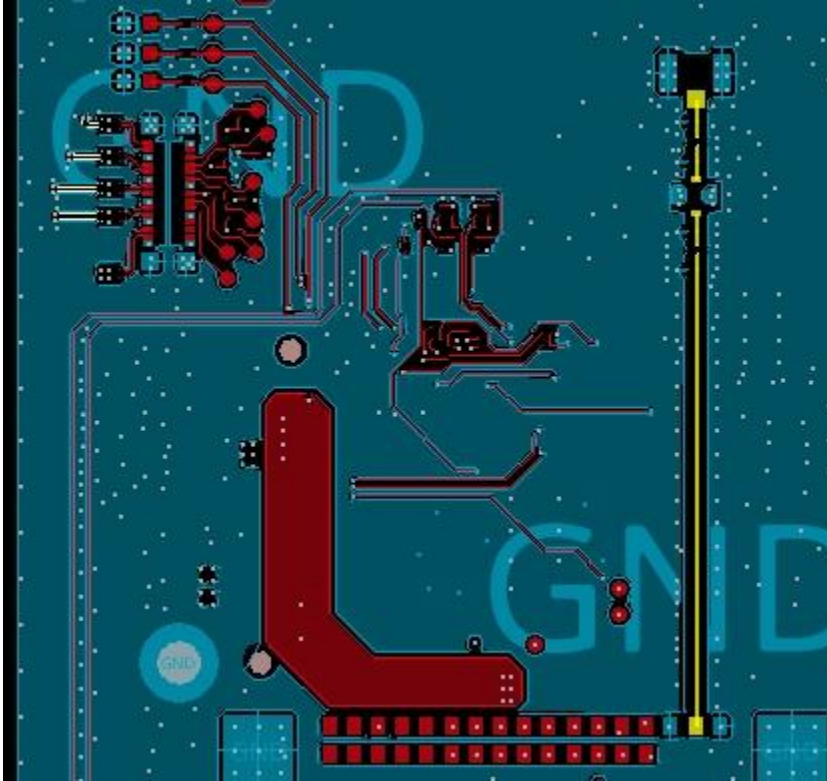

- Trace of Primary antenna, CM6125 only

The width is 0.3175mm and the length is 27.75mm. Impedance: 50ohm, keep out cooper of L2 under the trace..

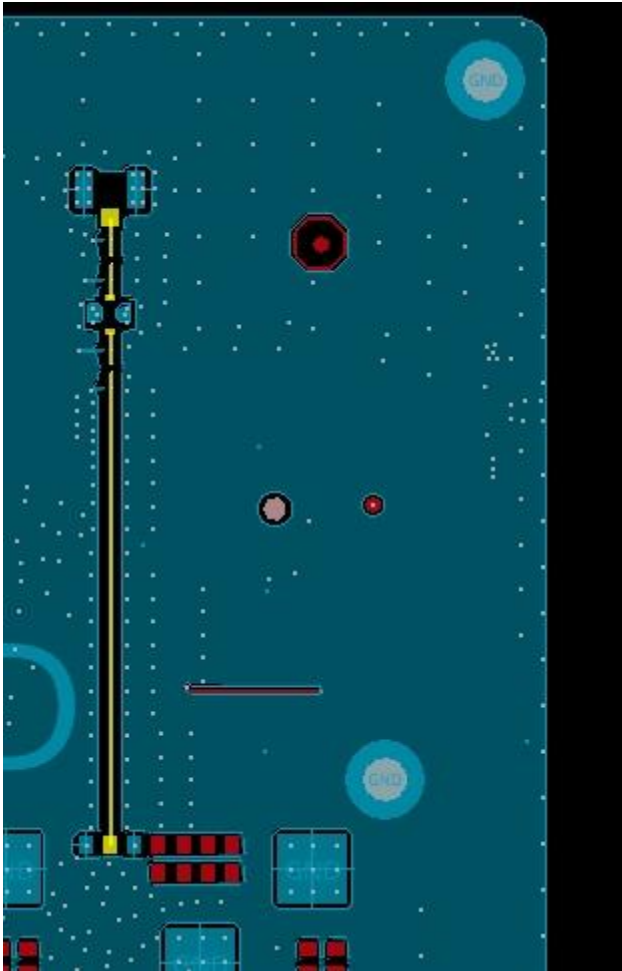

- Trace of Diversity antenna, CM6125 only

The width is 0.3175mm and the length is 18.5mm. Impedance: 50ohm, keep out cooper of L2 under the trace.

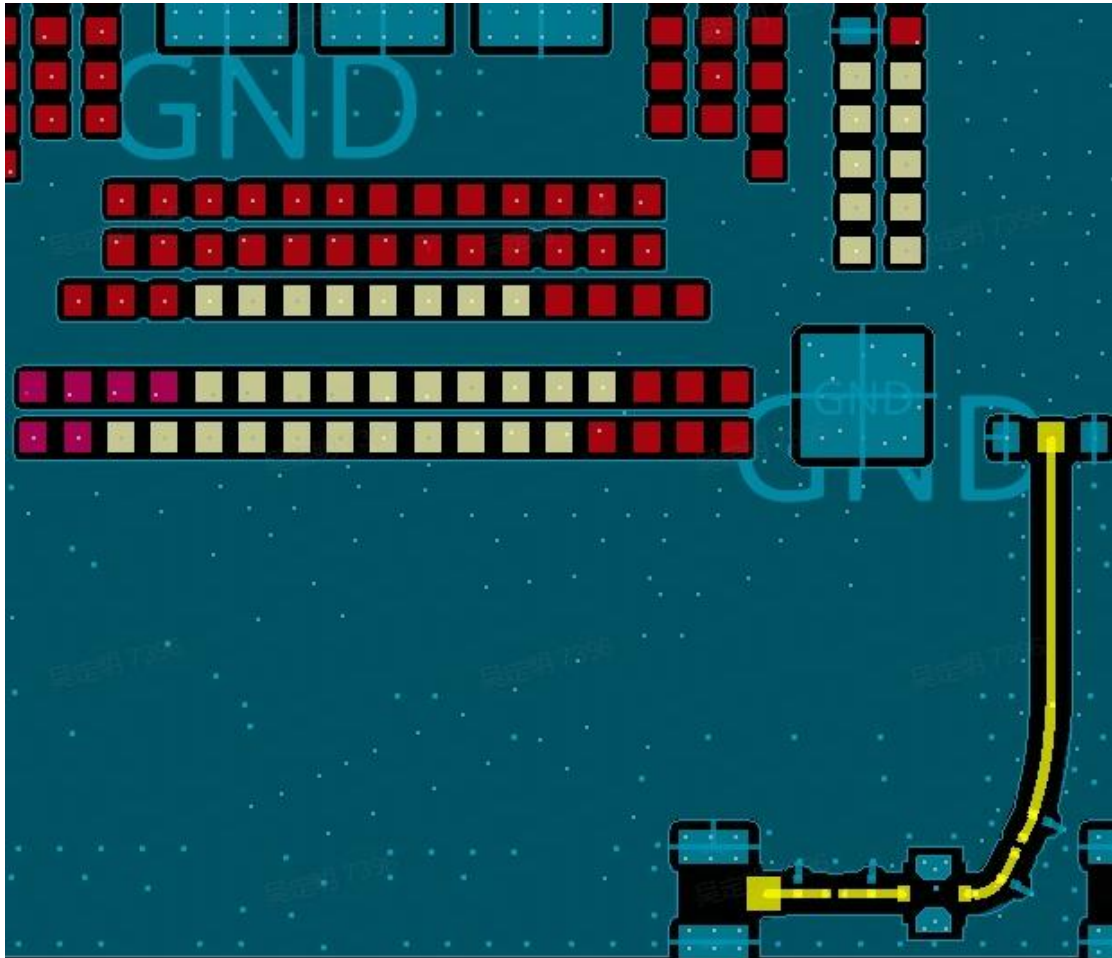

- Trace of GPS antenna, CM6125 only

The width is 0.3175mm and the length is 17.98mm. Impedance: 50ohm.

