



Test Report No:  
22B1055R-RFUIWL2V01-B

## TEST REPORT

### FCC / ISED Rules&Regulations

Product Name	T-Band
Brand Name	Talitrix
Model No.	TBQC4100OV1
PMN	T-Band
FCC ID	2AOHHTBAND
IC	23465-TBAND
Applicant's Name / Address	Thundercomm Technology Co., Ltd No. 107, Middle Datagu Road, Xiantao Street, Yubei District, Chongqing, China, 401122
Manufacturer's Name / Address	Thundercomm Technology Co., Ltd No. 107, Middle Datagu Road, Xiantao Street, Yubei District, Chongqing, China, 401122
Test Method Requested, Standard	FCC CFR Title 47 Part 15 Subpart C Section 15.247 RSS-247 Issue 2 (Feb. 2017) RSS-Gen Issue 5 (Feb. 2021) ANSI C63.10-2013
Verdict Summary	IN COMPLIANCE
Documented By	<i>Amelia Wu</i> Amelia Wu / Project Specialist
Approved By	<i>Rueyyan Lin</i> Rueyyan Lin / Supervisor
Date of Receipt	Nov. 30, 2022
Date of Issue	Jun. 19, 2023
Report Version	V1.0

## INDEX

	page
Competences and Guarantees.....	4
General Conditions.....	4
Revision History.....	5
1. General Information.....	6
1.1. EUT Description.....	6
1.2. Test Mode.....	8
1.3. Comments and Remarks.....	9
1.4. Tested System Details.....	9
1.5. Configuration of tested System.....	10
1.6. EUT Operation of during Test.....	11
1.7. Test Facility.....	12
1.8. List of Test Equipment.....	14
1.9. Measurement Uncertainty.....	15
1.10. Duty Cycle.....	16
2. AC Power Line Conducted Emission.....	17
2.1. Test Setup.....	17
2.2. Test Limit.....	17
2.3. Test Procedure.....	17
2.4. Test Specification.....	17
2.5. Test Result of AC Power Line Conducted Emission.....	18
3. Maximum Conducted Output Power.....	22
3.1. Test Setup.....	22
3.2. Test Limit.....	22
3.3. Test Procedures.....	22
3.4. Test Specification.....	22
3.5. Test Result of Maximum Conducted Output Power.....	23
4. Radiated Emission.....	24
4.1. Test Setup.....	24
4.2. Test Limit.....	25
4.3. Test Procedure.....	26
4.4. Test Specification.....	26
4.5. Test Result of Radiated Emissions (30 MHz ~ 1 GHz).....	27
4.6. Test Result of Radiated Emissions (1 GHz ~ 10 <sup>th</sup> Harmonic).....	29
5. Antenna Port Conducted Emission.....	32
5.1. Test Setup.....	32
5.2. Test Limit.....	32

5.3.	Test Procedure .....	32
5.4.	Test Specification.....	32
5.5.	Test Result of Antenna Port Conducted Emission .....	33
6.	Radiated Emission Band Edge.....	35
6.1.	Test Setup.....	35
6.2.	Test Limit .....	36
6.3.	Test Procedure .....	37
6.4.	Test Specification.....	37
6.5.	Test Result of Radiated Emission Band Edge.....	38
7.	Number of Hopping Frequency .....	42
7.1.	Test Setup.....	42
7.2.	Test Limit .....	42
7.3.	Test Procedures.....	43
7.4.	Test Specification.....	43
7.5.	Test Result of Number of Hopping Frequency .....	44
8.	Carrier Frequency Separation .....	45
8.1.	Test Setup.....	45
8.2.	Test Limit .....	45
8.3.	Test Procedures.....	45
8.4.	Test Specification.....	45
8.5.	Test Result of Carrier Frequency Separation .....	46
9.	20dB Bandwidth .....	48
9.1.	Test Setup.....	48
9.2.	Test Limit .....	48
9.3.	Test Procedures.....	49
9.4.	Test Specification.....	49
9.5.	Test Result of 20dB Bandwidth .....	50
10.	Dwell Time.....	52
10.1.	Test Setup.....	52
10.2.	Test Limit .....	52
10.3.	Test Procedures.....	53
10.4.	Test Specification.....	53
10.5.	Test Result of Dwell Time .....	54
	Appendix A .....	56
<input type="checkbox"/>	Test Result of Radiated Emissions Co-location .....	56
	Appendix B .....	57
<input type="checkbox"/>	Test Setup Photograph.....	57

## Competences and Guarantees

---

DEKRA is a testing laboratory competent to carry out the tests described in this report.

In order to assure the traceability to other national and international laboratories, DEKRA has a calibration and maintenance program for its measurement equipment.

DEKRA guarantees the reliability of the data presented in this report, which is the result of the measurements and the tests performed to the item under test on the date and under the conditions stated in the report and it is based on the knowledge and technical facilities available at DEKRA at the time of performance of the test.

DEKRA is liable to the client for the maintenance of the confidentiality of all information related to the item under test and the results of the test.

The results presented in this Test Report apply only to the particular item under test established in this document.

**IMPORTANT:** No parts of this report may be reproduced or quoted out of context, in any form or by any means, except in full, without the previous written permission of DEKRA.

## General Conditions

---

1. The test results relate only to the samples tested.
2. The test results shown in the test report are traceable to the national/international standard through the calibration report of the equipment and evaluated measurement uncertainty herein.
3. This report must not be used to claim product endorsement by TAF or any agency of the government.
4. The test report shall not be reproduced without the written approval of DEKRA Testing and Certification Co., Ltd.
5. Measurement uncertainties evaluated for each testing system and associated connections are given here to provide the system information for reference. Compliance determinations do not take into account measurement uncertainties for each testing system, but are based on the results of the compliance measurement.

## Revision History

---

Version	Description	Issued Date
V1.0	Initial issue of report	Jun. 19, 2023

## 1. General Information

### 1.1. EUT Description

Product Name	T-Band
Brand Name	Talitrix
Model No.	TBQC4100OV1
PMN	T-Band
EUT Voltage	DC 5V (host equipment) DC 3.85V for battery
Frequency Range	2402 ~ 2480 MHz
Channel Number	79 Channels
Type of Modulation	Frequency Hopping Spread Spectrum
Data Rate	BR uses a GFSK (1 Mbps) EDR uses a combination of $\pi/4$ -DQPSK (2 Mbps) and 8DPSK (3 Mbps)

Antenna Information				
Ant.	Brand Name	Model No.	Type	Gain (dBi)
0	WTT	ANT-1	PIFA	-0.08

EUT Operational Condition	
Testing Voltage	AC 120V/60Hz

Working Frequency of Each Channel							
Channel	Frequency	Channel	Frequency	Channel	Frequency	Channel	Frequency
00	2402 MHz	20	2422 MHz	40	2442 MHz	60	2462 MHz
01	2403 MHz	21	2423 MHz	41	2443 MHz	61	2463 MHz
02	2404 MHz	22	2424 MHz	42	2444 MHz	62	2464 MHz
03	2405 MHz	23	2425 MHz	43	2445 MHz	63	2465 MHz
04	2406 MHz	24	2426 MHz	44	2446 MHz	64	2466 MHz
05	2407 MHz	25	2427 MHz	45	2447 MHz	65	2467 MHz
06	2408 MHz	26	2428 MHz	46	2448 MHz	66	2468 MHz
07	2409 MHz	27	2429 MHz	47	2449 MHz	67	2469 MHz
08	2410 MHz	28	2430 MHz	48	2450 MHz	68	2470 MHz
09	2411 MHz	29	2431 MHz	49	2451 MHz	69	2471 MHz
10	2412 MHz	30	2432 MHz	50	2452 MHz	70	2472 MHz
11	2413 MHz	31	2433 MHz	51	2453 MHz	71	2473 MHz
12	2414 MHz	32	2434 MHz	52	2454 MHz	72	2474 MHz
13	2415 MHz	33	2435 MHz	53	2455 MHz	73	2475 MHz
14	2416 MHz	34	2436 MHz	54	2456 MHz	74	2476 MHz
15	2417 MHz	35	2437 MHz	55	2457 MHz	75	2477 MHz
16	2418 MHz	36	2438 MHz	56	2458 MHz	76	2478 MHz
17	2419 MHz	37	2439 MHz	57	2459 MHz	77	2479 MHz
18	2420 MHz	38	2440 MHz	58	2460 MHz	78	2480 MHz
19	2421 MHz	39	2441 MHz	59	2461 MHz	-	-

Note:

1. Regards to the frequency band operation; the lowest , middle and highest frequency of channel were selected to perform the test, and then shown on this report.
2. The above EUT information is declared by the manufacturer.

## 1.2. Test Mode

DEKRA has verified the construction and function in typical operation. All the test modes were carried out with the EUT in transmitting operation, which was shown in this test report and defined as follows:

Test Mode	Mode 1: Transmit – power by host equipment Mode 2: Transmit – power by charging			
Test Items	Test Mode	Modulation	Channel	Result
AC Power Line Conducted Emission	Mode 1, Mode 2	GFSK	78	Pass
Maximum Conducted Output Power	Mode 1	GFSK	00/39/78	Pass
		8-DPSK	00/39/78	Pass
Radiated Emission Below 1 GHz	Mode 1, Mode 2	GFSK	78	Pass
Radiated Emission Above 1 GHz	Mode 1	GFSK	00/39/78	Pass
		8-DPSK	00/39/78	Pass
Antenna Port Conducted Emission	Mode 1	GFSK	00/39/78	Pass
		8-DPSK	00/39/78	Pass
Radiated Emission Band Edge	Mode 1	GFSK	00/39/78	Pass
		8-DPSK	00/39/78	Pass
Number of Hopping Frequency	Mode 1	GFSK	Hopping mode	Pass
		8-DPSK		
Carrier Frequency Separation	Mode 1	GFSK	00/39/78	Pass
		8-DPSK	00/39/78	Pass
20dB Bandwidth	Mode 1	GFSK	00/39/78	Pass
		8-DPSK	00/39/78	Pass
Dwell Time	Mode 1	GFSK	00/39/78	Pass
		8-DPSK	00/39/78	Pass

### Note:

- Determining compliance shall be based on the results of the compliance measurement, not taking into account measurement instrumentation uncertainty.
- Pre-Scan has been conducted to determine the worst-case mode from all possible combinations between available modulations, data rates and antenna ports (if EUT with antenna diversity architecture).
- For below 1 GHz radiated emission and AC Power Line Conducted Emission have performed all modes of operation were investigated and the worst-case emissions are reported.
- The EUT was performed at X axis, Y axis and Z axis position for radiated emission and band edge tests. The worst case was found at Z axis, so the measurement will follow this same test configuration.
- The EUT could be applied with WWAN LTE Cat-M1 and Bluetooth BR+EDR function, Radiated Emission Co-location (Please refer to Appendix A) test is added for simultaneously transmit between WWAN LTE Cat-M1 and Bluetooth BR+EDR function.
- The EUT contains one WWAN module (brand name: Quectel, model: EM9191, FCC ID: XMR201912BG77).



### 1.3. Comments and Remarks

The product specification and testing instructions for the EUT declared in the report are provided by the manufacturer who will take all responsibilities for the accuracy.

### 1.4. Tested System Details

The types for all equipment, plus descriptions of all cables used in the tested system.

#### <power by host equipment>

	Product	Manufacturer	Model No.	Serial No.
1	Notebook	Lenove	80XL	PF0SXXY1
2	USB to LAN Converter	DEKRA	A29	N/A

#### <power by charging>

	Product	Manufacturer	Model No.	Serial No.
1	Power bank	Shenzhen Cholipower Technology Co.,LTD	CLP802	N/A
2	Adapter	DONGGUAN SHELL ELECTRONIC LIMITED	S-TR-153B	N/A

### 1.5. Configuration of tested System

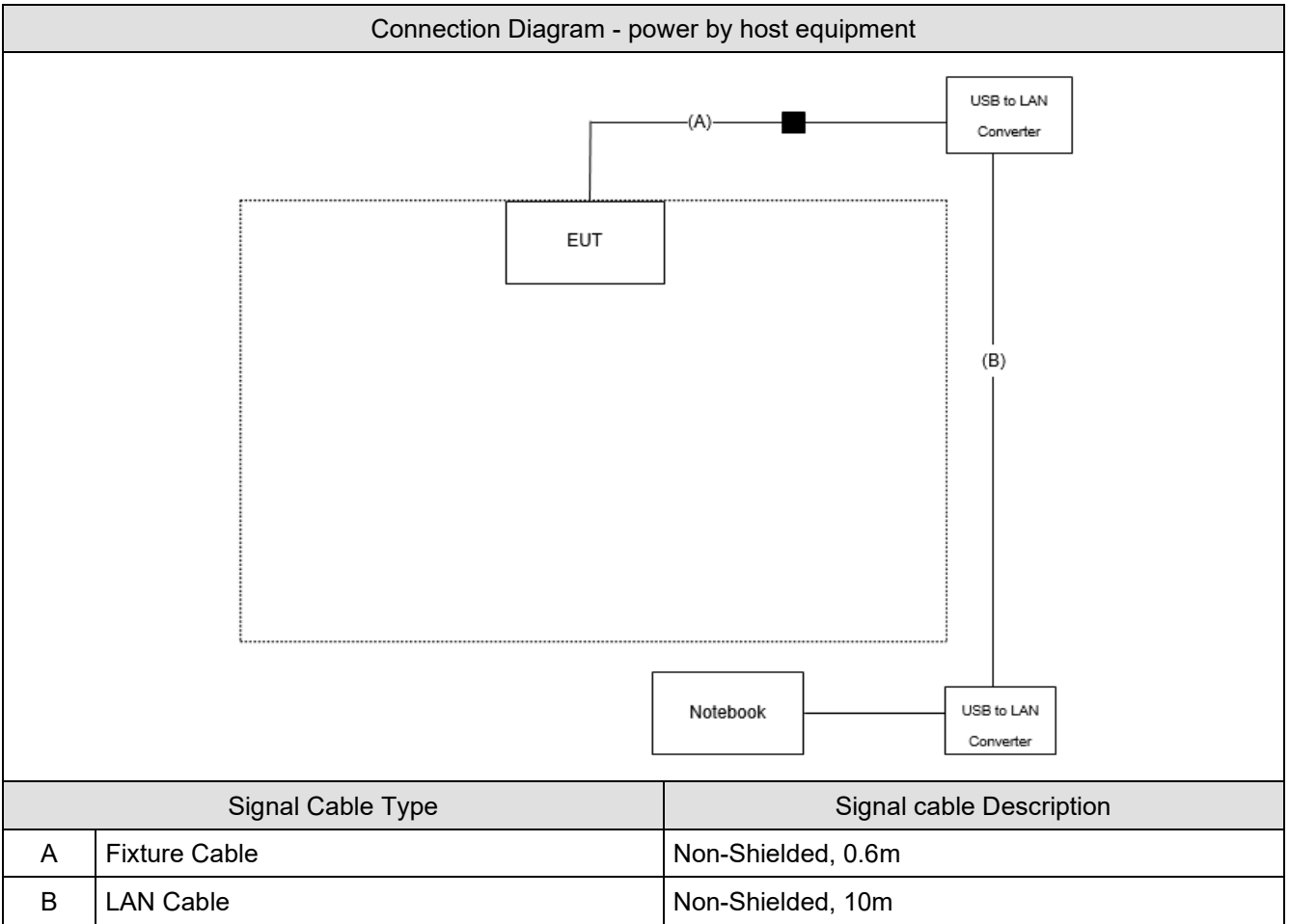

Connection Diagram - power by charging

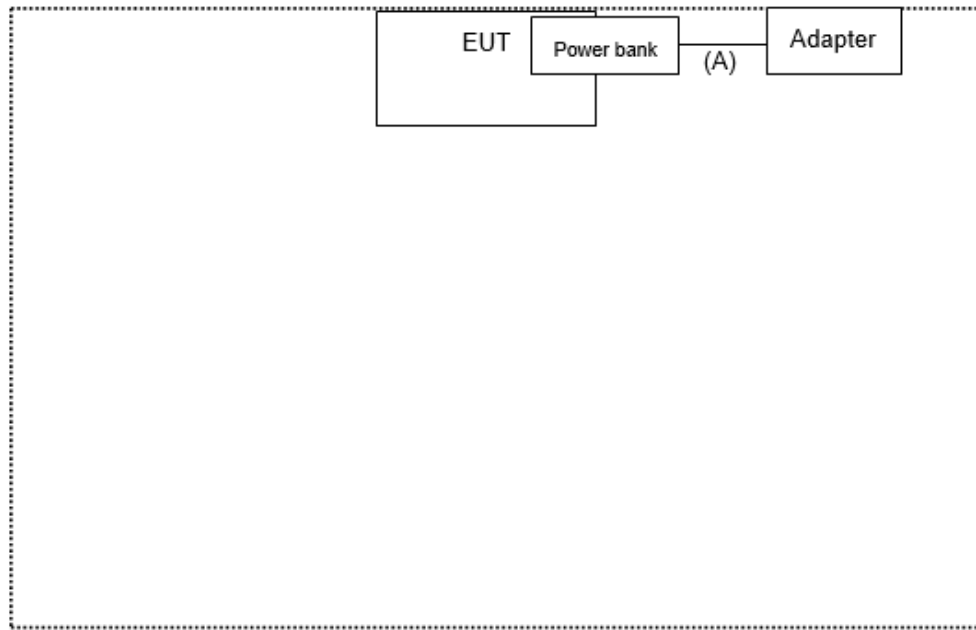

Signal Cable Type		Signal cable Description
A	USB Cable	Shielded, 1.5m

### 1.6. EUT Operation of during Test

1	Execute control command by software "QRCT v4.0.00204.0".
2	Configure the test mode, the test channel, and the data rate.
3	Press "Start TX" to start the continuous transmitting.
4	Verify that the EUT works properly.

## 1.7. Test Facility

Ambient conditions in the laboratory:

Items	Test Item	Actually	Tested by	Test Date	Test Site
Temperature (°C)	AC Power Line Conducted Emission	23	Ling Chen	2023/04/10	HC-SR02
Humidity (%RH)		59			
Temperature (°C)	Maximum Conducted Output Power	21	Scott Chang	2023/04/13	HC-SR12
Humidity (%RH)		55			
Temperature (°C)	Radiated Emission	22.4 ~ 24.4	Ling Chen	2023/03/30 ~ 2023/04/06	HC-CB02
Humidity (%RH)		61 ~ 64			
Temperature (°C)	Antenna Port Conducted Emission	21	Scott Chang	2023/04/13	HC-SR12
Humidity (%RH)		55			
Temperature (°C)	Radiated Emission Band Edge	22.4	Ling Chen	2023/03/30	HC-CB02
Humidity (%RH)		64			
Temperature (°C)	Number of Hopping Frequency	21	Scott Chang	2023/04/13	HC-SR12
Humidity (%RH)		55			
Temperature (°C)	Carrier Frequency Separation	21	Scott Chang	2023/04/13	HC-SR12
Humidity (%RH)		55			
Temperature (°C)	20dB Bandwidth	21	Scott Chang	2023/04/13	HC-SR12
Humidity (%RH)		55			
Temperature (°C)	Dwell Time	21	Scott Chang	2023/04/13	HC-SR12
Humidity (%RH)		55			

Note: Test site information refers to Laboratory Information.

**Laboratory Information**

**USA** : **FCC Registration Number: TW3024**  
**Canada** : **CAB identifier : TW3024**

The address and introduction of DEKRA Testing and Certification Co., Ltd. laboratories can be founded in our Web site: <http://www.dekra.com.tw>

If you have any comments, please don't hesitate to contact us. Our test sites as below:

Test Laboratory	DEKRA Testing and Certification Co., Ltd.
Address	1. No.372-2, Sec. 4, Zhongxing Rd., Zhudong Township, Hsinchu County 31061, Taiwan, R.O.C. 2. No.372, Sec. 4, Zhongxing Rd., Zhudong Township, Hsinchu County 31061, Taiwan, R.O.C.
Phone number	1. +886-3-582-8001 2. +886-3-582-8001
Fax number	1. +886-3-582-8958 2. +886-3-582-8958
Email address	<a href="mailto:info.tw@dekra.com">info.tw@dekra.com</a>
Website	<a href="http://www.dekra.com.tw">http://www.dekra.com.tw</a>
Note: Test site number for address 1 includes HC-SR02. Test site number for address 2 includes HC-CB02, HC-CB03, HC-CB04, HC-SR10 and HC-SR12.	

## 1.8. List of Test Equipment

### HC-SR02

Instrument	Manufacturer	Model No.	Serial No.	Cal. Date	Next Cal. Date
Artificial Mains Network	R&S	ENV4200	848411/010	2022/12/19	2023/12/18
EMI Test Receiver	R&S	ESR3	102608	2022/09/28	2023/09/27
Two-Line V-Network	R&S	ENV216	100096	2022/05/17	2023/05/16
Coaxial Cable(9 m)	Harbour	RG-400	HC-SR02	2022/08/15	2023/08/14
EMI Testing System	AUDIX	e3 210616 dekra V9	HC-SR02	N/A	N/A

### HC-SR12

Instrument	Manufacturer	Model No.	Serial No.	Cal. Date	Next Cal. Date
High Speed Peak Power Meter Dual Input	Anritsu	ML2496A	1602004	2022/11/02	2023/11/01
Pulse Power Sensor	Anritsu	MA2411B	1531043	2022/11/02	2023/11/01
Pulse Power Sensor	Anritsu	MA2411B	1531044	2022/11/02	2023/11/01
Signal and Spectrum Analyzer	R&S	FSVA40	101435	2022/05/30	2023/05/29

### HC-CB02

Instrument	Manufacturer	Model No.	Serial No.	Cal. Date	Next Cal. Date
Signal and Spectrum Analyzer	R&S	FSVA40	101435	2022/05/30	2023/05/29
Signal Analyzer	R&S	FSVA40	101455	2022/09/29	2023/09/28
EXA Signal Analyzer	Keysight	N9010A	MY51440132	2022/12/13	2023/12/12
Trilog Broadband Antenna	Schwarzbeck	VULB 9168	1272	2022/05/19	2023/05/18
Horn Antenna	Schwarzbeck	BBHA 9120D	639	2022/05/06	2023/05/05
Double Ridged Horn Antenna	RF SPIN	DRH18-E	211211A18E N	2022/11/15	2023/11/14
Horn Antenna	Schwarzbeck	BBHA 9170	203	2023/02/13	2024/02/12
Pre-Amplifier	EMCI	EMC01820I	980365	2023/04/07	2024/04/06
Pre-Amplifier	EMEC	EM01G18GA	060741	2022/05/06	2023/05/05
Pre-Amplifier	DEKRA	AP-400C	201801231	2022/09/27	2023/09/26
EMI Test Receiver	R&S	ESR7	102260	2022/12/01	2023/11/30
Magnetic Loop Antenna	Teseq	HLA 6121	44287	2022/10/21	2023/10/20
Coaxial Cable(13m)	Suhner	SF104	HC-CB02	2022/08/15	2023/08/14
Coaxial Cable(3m)	Suhner,Rosnol	SF102_UP026 4	HC-CB02_1	2022/08/14	2023/08/13
Radiated Software	AUDIX	e3 V9	HC-CB02_1	N/A	N/A

Note: All equipment upon which need to calibrated are with calibration period of 1 year.

## 1.9. Measurement Uncertainty

Uncertainties have been calculated according to the DEKRA internal document with the emissions test results be included in the report. The measurement uncertainties given below are based on a 95% confidence level (based on a coverage factor ( $k=2$ )).

Test item	Uncertainty
AC Power Line Conducted Emission	$\pm 2.34$ dB
Maximum Conducted Output Power	$\pm 1.16$ dB
Radiated Emission	$\pm 3.52$ dB below 1 GHz $\pm 3.56$ dB above 1 GHz
Antenna Port Conducted Emission	$\pm 2.47$ dB
Radiated Emission Band Edge	$\pm 3.56$ dB
Number of Hopping Frequency	N/A
Carrier Frequency Separation	$\pm 282.55$ Hz
20dB Bandwidth	$\pm 282.55$ Hz
Dwell Time	$\pm 19.555$ msec

### 1.10. Duty Cycle

Modulation	On Times (ms)	On+Off Times (ms)	Duty Cycle (%)	Duty Cycle Correction Factor (dB)
GFSK	2.880	100.000	2.88	-30.81
8-DPSK	2.880	100.000	2.88	-30.81

Note: If the duty cycle correction factor lower than -20dB, the Max. duty cycle correction factor is -20dB.

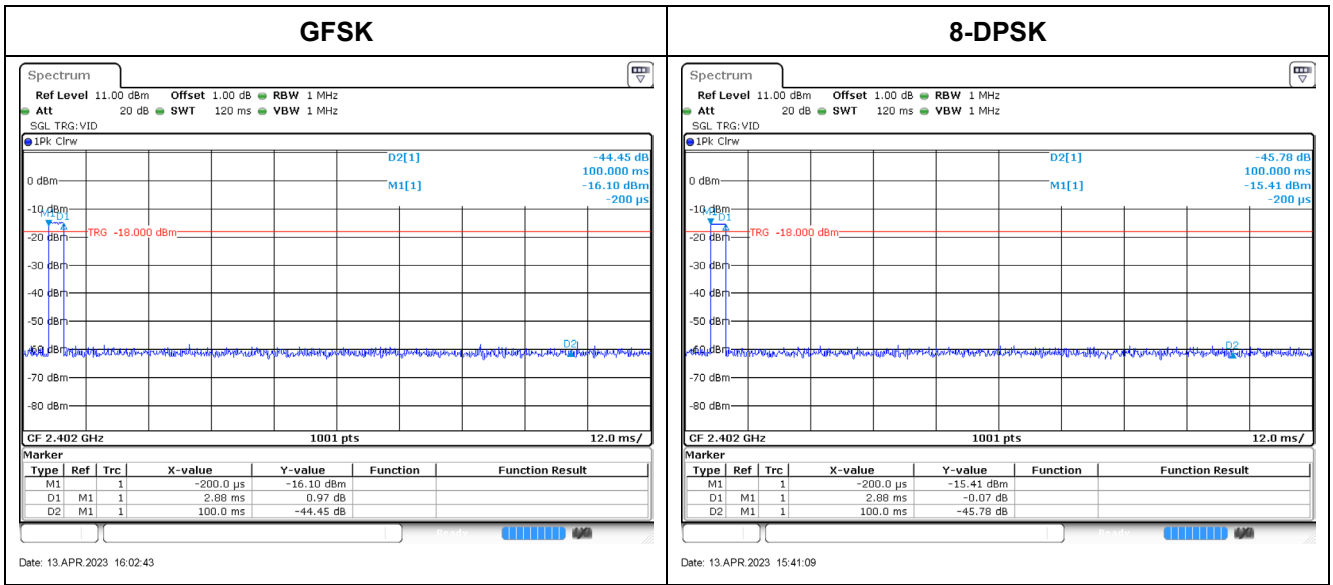



## 2. AC Power Line Conducted Emission

### 2.1. Test Setup

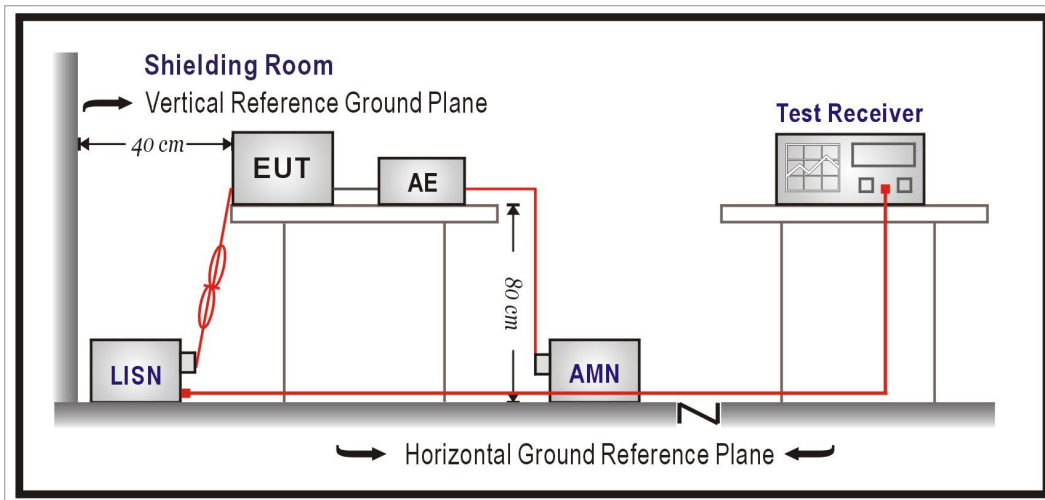

### 2.2. Test Limit

Frequency (MHz)	QP (dBuV)	AV (dBuV)
0.15 - 0.50	66 - 56	56 - 46
0.50 - 5.0	56	46
5.0 - 30	60	50

Remarks: In the above table, the tighter limit applies at the band edges.

### 2.3. Test Procedure

The EUT and simulators are connected to the main power through a line impedance stabilization network (L.I.S.N.). This provides a 50 ohm /50uH coupling impedance for the measuring equipment. The peripheral devices are also connected to the main power through a LISN that provides a 50ohm /50uH coupling impedance with 50 ohm termination. (Please refer to the block diagram of the test setup and photographs.)

Both sides of A.C. line are checked for maximum conducted interference. In order to find the maximum emission, the relative positions of equipment and all of the interface cables must be changed according to ANSI C63.10: 2013 on conducted measurement.

Conducted emissions were investigated over the frequency range from 0.15 MHz to 30 MHz using a receiver bandwidth of 9 kHz.

### 2.4. Test Specification

According to FCC Part 15 Subpart C Paragraph 15.207 / IC RSS-Gen Issue 5.

## 2.5. Test Result of AC Power Line Conducted Emission

Test Mode	Mode 1: Transmit – power by host equipment	Phase	Line
Test Condition	GFSK / 2480 MHz		

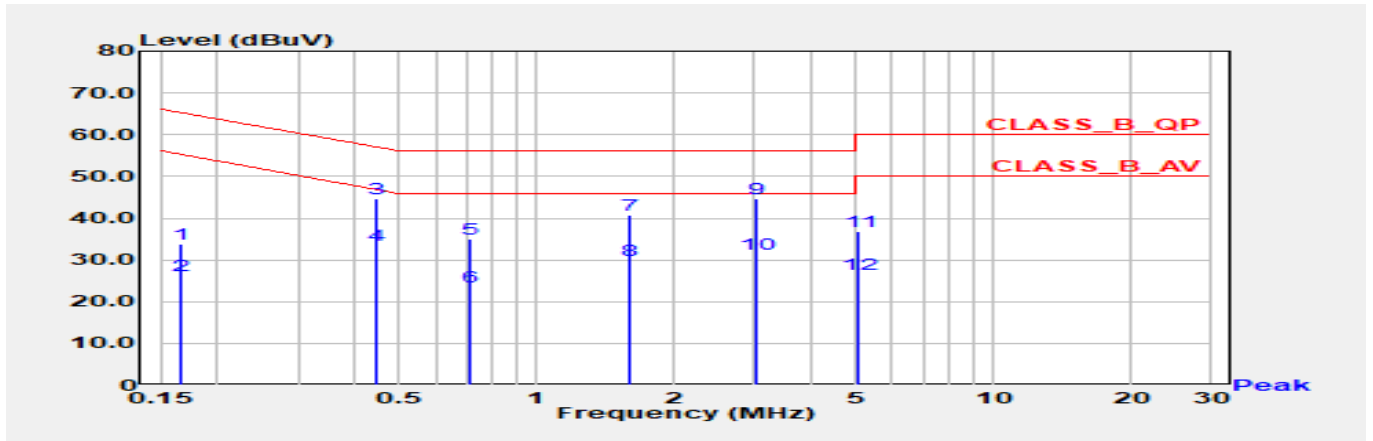

No	Frequency (MHz)	Emission Level (dBuV)	Limit (dBuV)	Margin (dB)	Reading Level (dBuV)	Correct Factor (dB)	Detector Type
1	0.166	33.83	65.17	-31.34	24.21	9.62	QP
2	0.166	26.16	55.17	-29.01	16.54	9.62	AV
3	0.442	44.73	57.01	-12.28	35.09	9.65	QP
4	0.442	33.47	47.01	-13.55	23.82	9.65	AV
5	0.717	34.97	56.00	-21.03	25.30	9.67	QP
6	0.717	23.49	46.00	-22.51	13.82	9.67	AV
7	1.601	40.85	56.00	-15.15	31.12	9.73	QP
8	1.601	30.03	46.00	-15.97	20.30	9.73	AV
*9	3.037	44.73	56.00	-11.27	34.93	9.80	QP
10	3.037	31.51	46.00	-14.49	21.72	9.80	AV
11	5.082	36.96	60.00	-23.04	27.06	9.90	QP
12	5.082	26.42	50.00	-23.58	16.53	9.90	AV

Remark:

1. "\*" means this data is the worst emission level.
2. Emission Level = Reading Level + Correct Factor (Correct Factor = LISN Insertion Loss + Cable Loss).
3. Margin = Emission Level - Limit.

Test Mode	Mode 1: Transmit – power by host equipment	Phase	Neutral
Test Condition	GFSK / 2480 MHz		

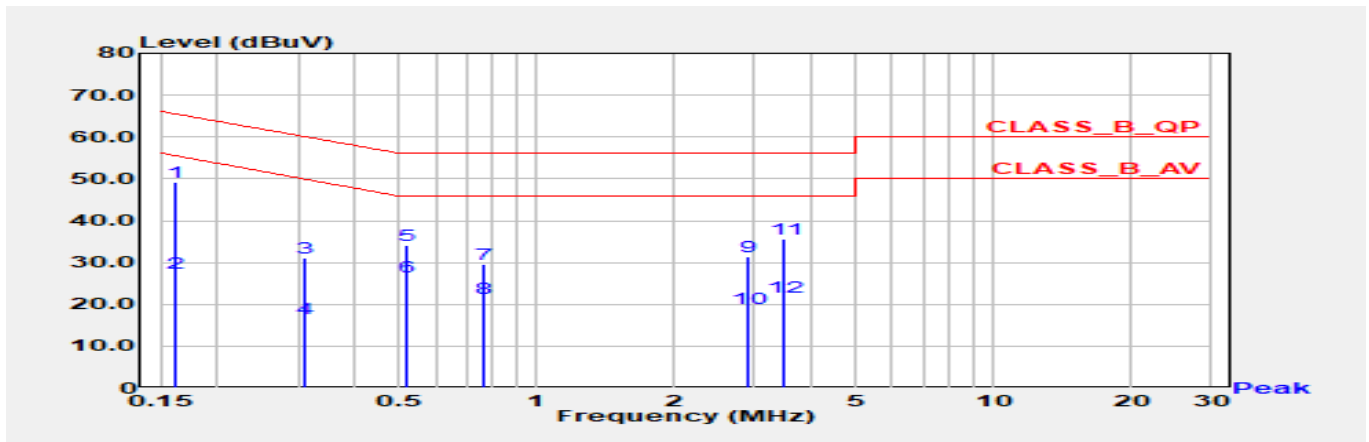

No	Frequency (MHz)	Emission Level (dBuV)	Limit (dBuV)	Margin (dB)	Reading Level (dBuV)	Correct Factor (dB)	Detector Type
*1	0.161	49.20	65.40	-16.20	39.58	9.62	QP
2	0.161	27.42	55.40	-27.98	17.81	9.62	AV
3	0.312	31.14	59.92	-28.77	21.52	9.62	QP
4	0.312	16.48	49.92	-33.43	6.86	9.62	AV
5	0.521	34.08	56.00	-21.92	24.43	9.65	QP
6	0.521	26.52	46.00	-19.48	16.87	9.65	AV
7	0.769	29.69	56.00	-26.31	20.02	9.67	QP
8	0.769	21.36	46.00	-24.64	11.69	9.67	AV
9	2.886	31.31	56.00	-24.69	21.51	9.80	QP
10	2.886	19.10	46.00	-26.90	9.30	9.80	AV
11	3.491	35.75	56.00	-20.25	25.92	9.83	QP
12	3.491	21.67	46.00	-24.33	11.84	9.83	AV

Remark:

1. "\*" means this data is the worst emission level.
2. Emission Level = Reading Level + Correct Factor (Correct Factor = LISN Insertion Loss + Cable Loss).
3. Margin = Emission Level - Limit.

Test Mode	Mode 2: Transmit – power by charging	Phase	Line
Test Condition	GFSK / 2480 MHz		

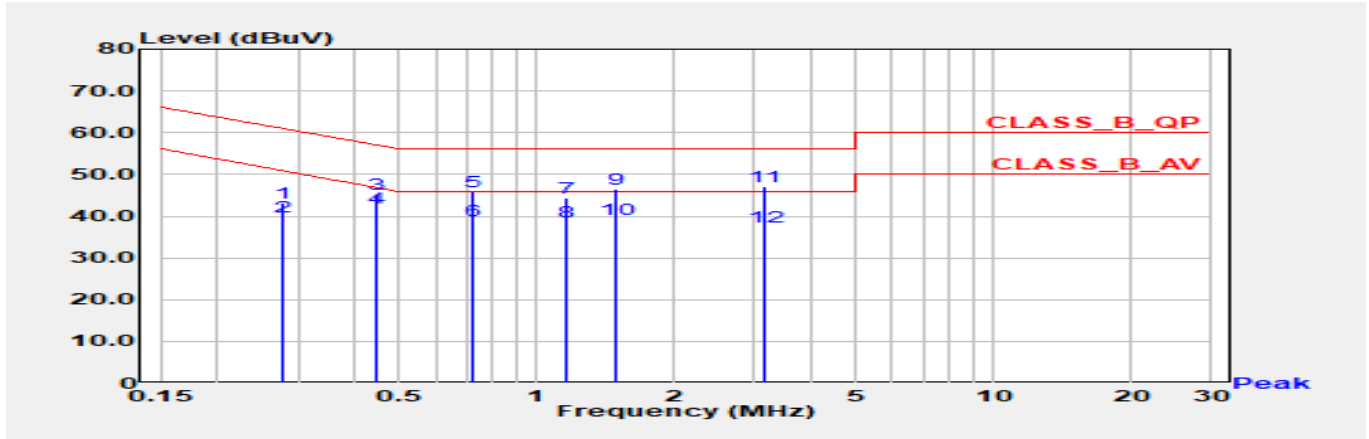

No	Frequency (MHz)	Emission Level (dBuV)	Limit (dBuV)	Margin (dB)	Reading Level (dBuV)	Correct Factor (dB)	Detector Type
1	0.276	43.17	60.94	-17.76	33.55	9.62	QP
2	0.276	39.99	50.94	-10.95	30.36	9.62	AV
3	0.442	45.38	57.01	-11.63	35.74	9.65	QP
*4	0.442	42.04	47.01	-4.97	32.40	9.65	AV
5	0.719	45.90	56.00	-10.10	36.23	9.67	QP
6	0.719	39.09	46.00	-6.91	29.42	9.67	AV
7	1.162	44.48	56.00	-11.52	34.77	9.71	QP
8	1.162	38.74	46.00	-7.26	29.03	9.71	AV
9	1.491	46.51	56.00	-9.49	36.79	9.72	QP
10	1.491	39.20	46.00	-6.80	29.47	9.72	AV
11	3.147	47.11	56.00	-8.89	37.30	9.80	QP
12	3.147	37.43	46.00	-8.57	27.63	9.80	AV

Remark:

1. "\*" means this data is the worst emission level.
2. Emission Level = Reading Level + Correct Factor (Correct Factor = LISN Insertion Loss + Cable Loss).
3. Margin = Emission Level - Limit.

Test Mode	Mode 2: Transmit – power by charging	Phase	Neutral
Test Condition	GFSK / 2480 MHz		

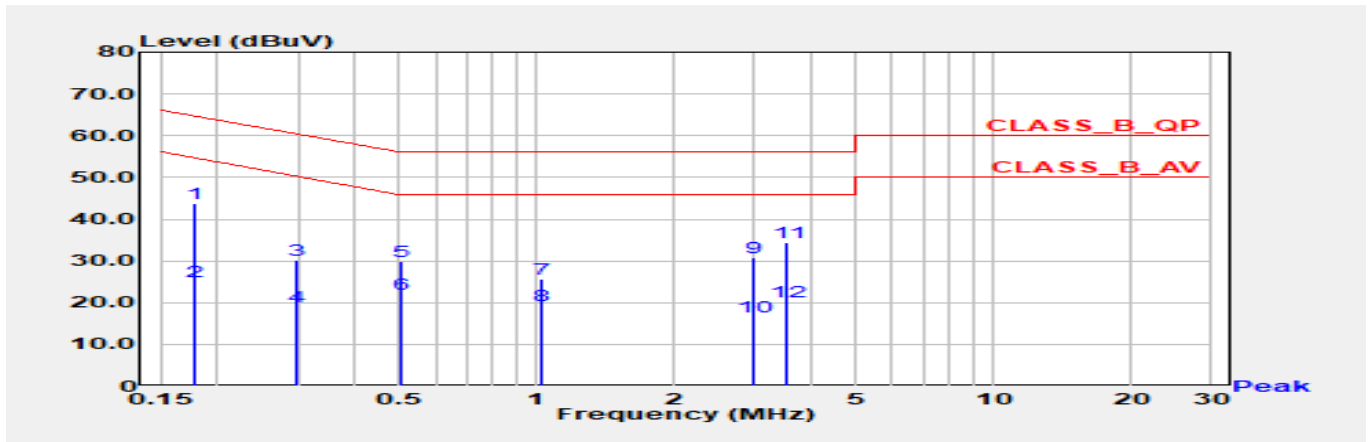

No	Frequency (MHz)	Emission Level (dBuV)	Limit (dBuV)	Margin (dB)	Reading Level (dBuV)	Correct Factor (dB)	Detector Type
*1	0.179	43.81	64.52	-20.72	34.19	9.62	QP
2	0.179	25.05	54.52	-29.47	15.43	9.62	AV
3	0.296	30.06	60.35	-30.29	20.43	9.62	QP
4	0.296	19.14	50.35	-31.20	9.52	9.62	AV
5	0.503	29.77	56.00	-26.23	20.13	9.64	QP
6	0.503	22.16	46.00	-23.84	12.51	9.64	AV
7	1.030	25.68	56.00	-30.32	15.98	9.70	QP
8	1.030	19.20	46.00	-26.80	9.50	9.70	AV
9	2.998	30.69	56.00	-25.31	20.89	9.80	QP
10	2.998	16.51	46.00	-29.49	6.71	9.80	AV
11	3.538	34.46	56.00	-21.54	24.63	9.83	QP
12	3.538	20.13	46.00	-25.87	10.31	9.83	AV

Remark:

1. "\*" means this data is the worst emission level.
2. Emission Level = Reading Level + Correct Factor (Correct Factor = LISN Insertion Loss + Cable Loss).
3. Margin = Emission Level - Limit.

### 3. Maximum Conducted Output Power

#### 3.1. Test Setup

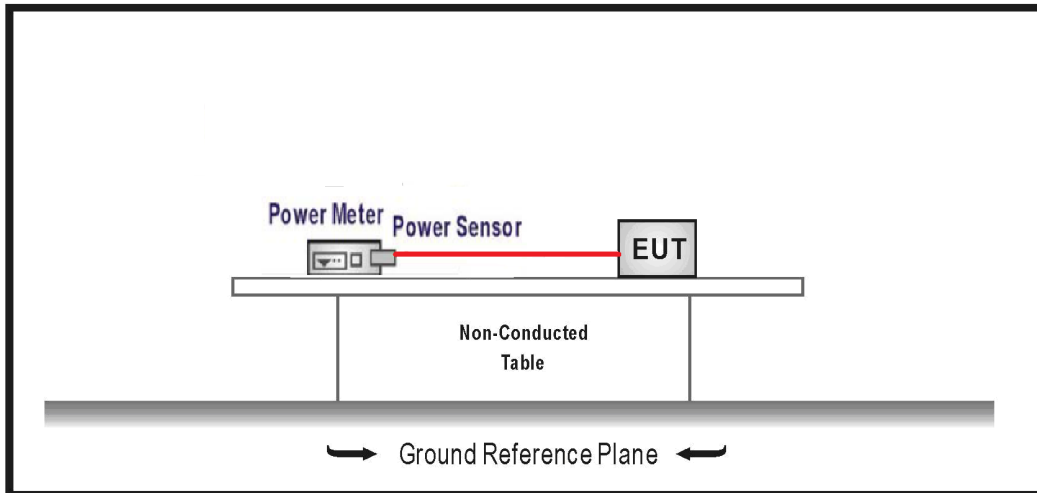

#### 3.2. Test Limit

For FCC:

For frequency hopping systems operating in the 902 ~ 928 MHz band: 1 Watt for systems employing at least 50 hopping channels; and 0.25 Watts for systems employing less than 50 hopping channels.

For frequency hopping systems operating in the 2400 ~ 2483.5 MHz band employing at least 75 non-overlapping hopping channels, and all frequency hopping systems in the 5725 ~ 5850 MHz band: 1 watt. For all other frequency hopping systems in the 2400 ~ 2483.5 MHz band: 0.125 watts.

For ISSED:

According to RSS-247 Issue 2, the maximum peak power shall be less 1 Watt.

#### 3.3. Test Procedures

The EUT was setup according to ANSI C63.10: 2013 and tested according to FHSS test procedure of FCC KDB 558074 D01 v05r02 for compliance to FCC 47CFR 15.247 / RSS-247 issue 2 requirements.

#### 3.4. Test Specification

According to FCC Part 15 Subpart C Paragraph 15.247 / IC RSS-247 Issue 2.

### 3.5. Test Result of Maximum Conducted Output Power

Modulation	Channel	Frequency (MHz)	Measure Level (dBm)	Limit (dBm)	Result
GFSK	00	2402	8.97	$\leq 20.97$	Pass
	39	2441	10.02	$\leq 20.97$	Pass
	78	2480	8.88	$\leq 20.97$	Pass
8-DPSK	00	2402	9.25	$\leq 20.97$	Pass
	39	2441	10.35	$\leq 20.97$	Pass
	78	2480	9.15	$\leq 20.97$	Pass

## 4. Radiated Emission

### 4.1. Test Setup

9 kHz ~ 30 MHz

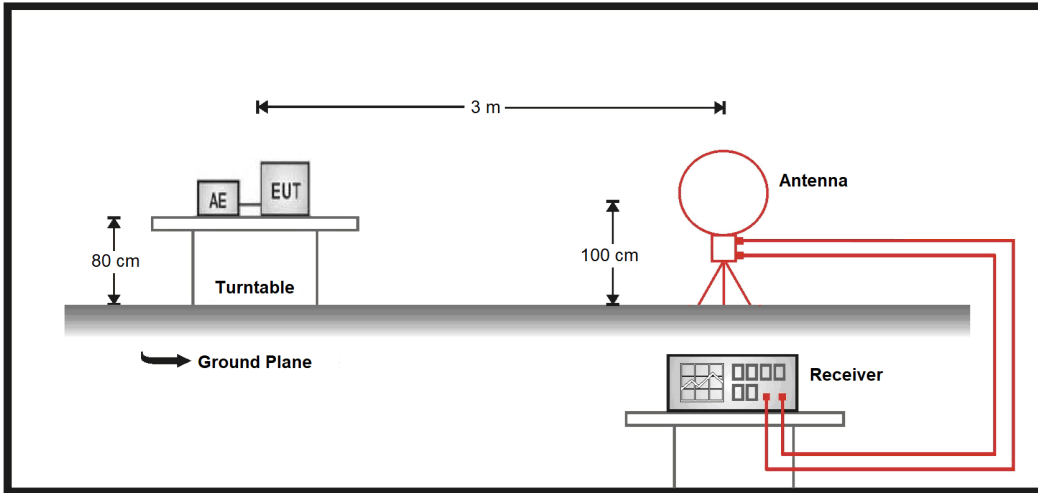

30 MHz ~ 1 GHz

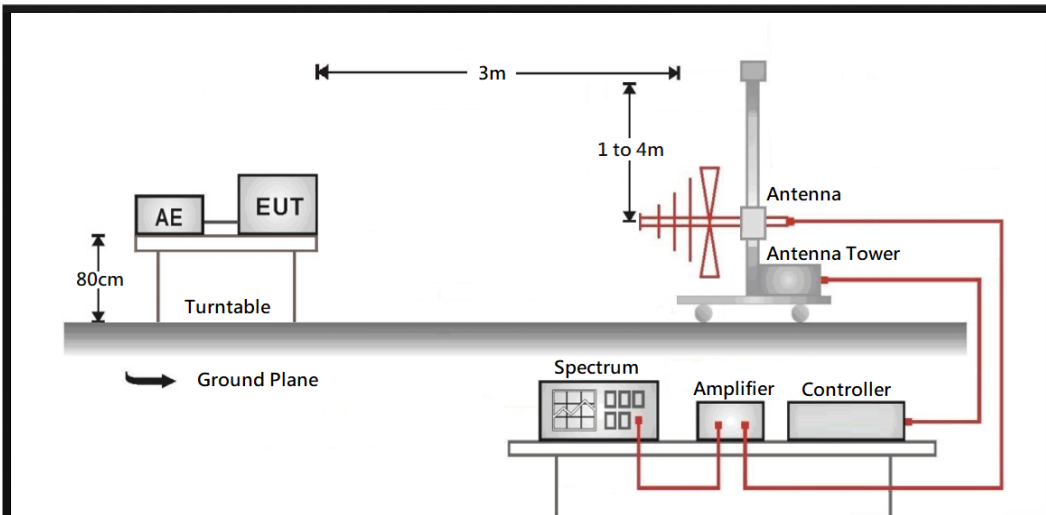



Above 1 GHz

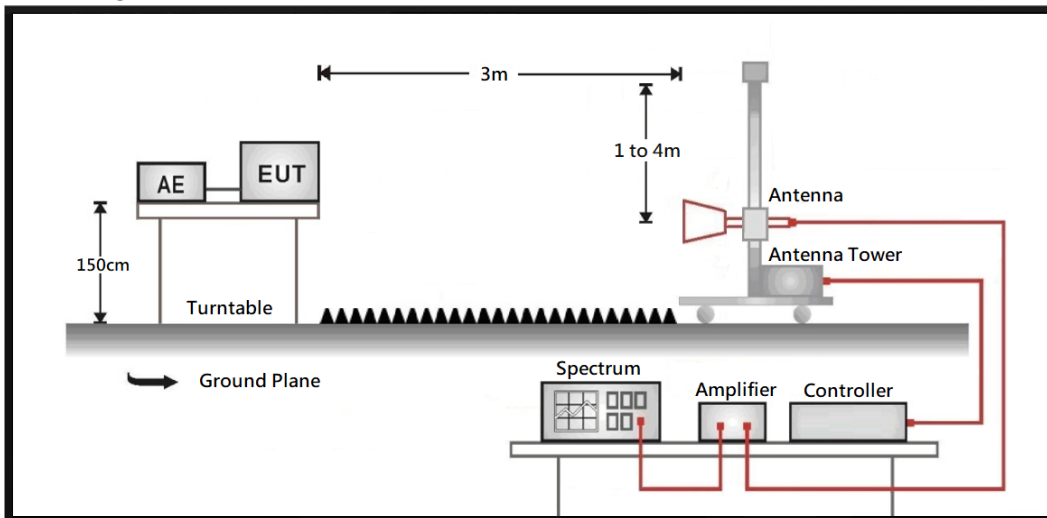

## 4.2. Test Limit

Emissions radiated outside of the specified frequency bands, except for harmonics, shall be attenuated by at least 20 dB below the level of the fundamental or to the general radiated emission limit in paragraph 15.209 / RSS-Gen Issue 5 Section 8.9, whichever is the lesser attenuation.

Frequency (MHz)	Field strength (uV/m)	Field strength (dBuV/m)	Measurement distance (m)
0.009 – 0.490	2400/F(kHz)	20 log (2400/F(kHz))	300
0.490 – 1.705	24000/F(kHz)	20 log (24000/F(kHz))	30
1.705 - 30	30	29.5	30
30 - 88	100	40	3
88 - 216	150	43.5	3
216 - 960	200	46	3
Above 960	500	54	3

Remarks:

1. Field strength (dBuV/m) = 20 log Field strength (uV/m)
2. In the Above Table, the tighter limit applies at the band edges.
3. Distance refers to the distance in meters between the measuring instrument antenna and the closed point of any part of the device or system.

### 4.3. Test Procedure

For FCC:

The EUT was setup according to ANSI C63.10: 2013 and tested according to FHSS test procedure of FCC KDB 558074 D01 v05r02 for compliance to FCC 47CFR 15.247 requirements.

The EUT and its simulators are placed on a turn table which is 0.8 or 1.5 meter above ground. The turn table can rotate 360 degrees to determine the position of the maximum emission level. The antenna can move up and down between 1 meter and 4 meters to find out the maximum emission level.

Both horizontal and vertical polarization of the antenna are set on measurement. In order to find the maximum emission, all of the interface cables must be manipulated according to ANSI C63.10: 2013 on radiated measurement.

On any frequency or frequencies from 9kHz(inclde The the lowest oscillator frequency generated within the device up to the 10th harmonic) to 1000 MHz, the limit shown are based on measuring equipment employing a quasi-peak detector function and on any frequency or frequencies above 1000 MHz the radiated limit shown are based upon the use of measurement instrumentation employing an average detector function. When average radiated emission measurement are included emission measurement below 1000 MHz, there also is a limit on the radio frequency emissions, as measured using instrumentation with a peak detector function, corresponding to 20 dB above the maximum permitted average limit.

The bandwidth below 1 GHz setting on the field strength meter is 120 kHz and above 1 GHz is 1MHz.

For ISED:

The EUT and its simulators are placed on a turn table which is 0.8 (under 1 G) or 1.5(above 1 G) meter above ground. The turn table can rotate 360 degrees to determine the position of the maximum emission level. The EUT was positioned such that the distance from antenna to the EUT was 3 meters.The antenna can move up and down between 1 meter and 4 meters to find out the maximum emission level.

Both horizontal and vertical polarization of the antenna are set on measurement. In order to find the maximum emission, all of the interface cables must be manipulated according to ANSI C63.10: 2013 on radiated measurement.

On any frequency or frequencies from 9 kHz(inclde The the lowest oscillator frequency generated within the device up to the 10th harmonic) to 1000 MHz, the limit shown are based on measuring equipment employing a quasi-peak detector function and on any frequency or frequencies above 1000 MHz the radiated limit shown are based upon the use of measurement instrumentation employing an average detector function. When average radiated emission measurement are included emission measurement below 1000 MHz, there also is a limit on the radio frequency emissions, as measured using instrumentation with a peak detector function, corresponding to 20 dB above the maximum permitted average limit.

The bandwidth below 1GHz setting on the field strength meter is 120 kHz and above 1 GHz is 1 MHz.

### 4.4. Test Specification

According to FCC Part 15 Subpart C Paragraph 15.247 / IC RSS-247 Issue 2.

### 4.5. Test Result of Radiated Emissions (30 MHz ~ 1 GHz)

Mode 1: Transmit – power by host equipment

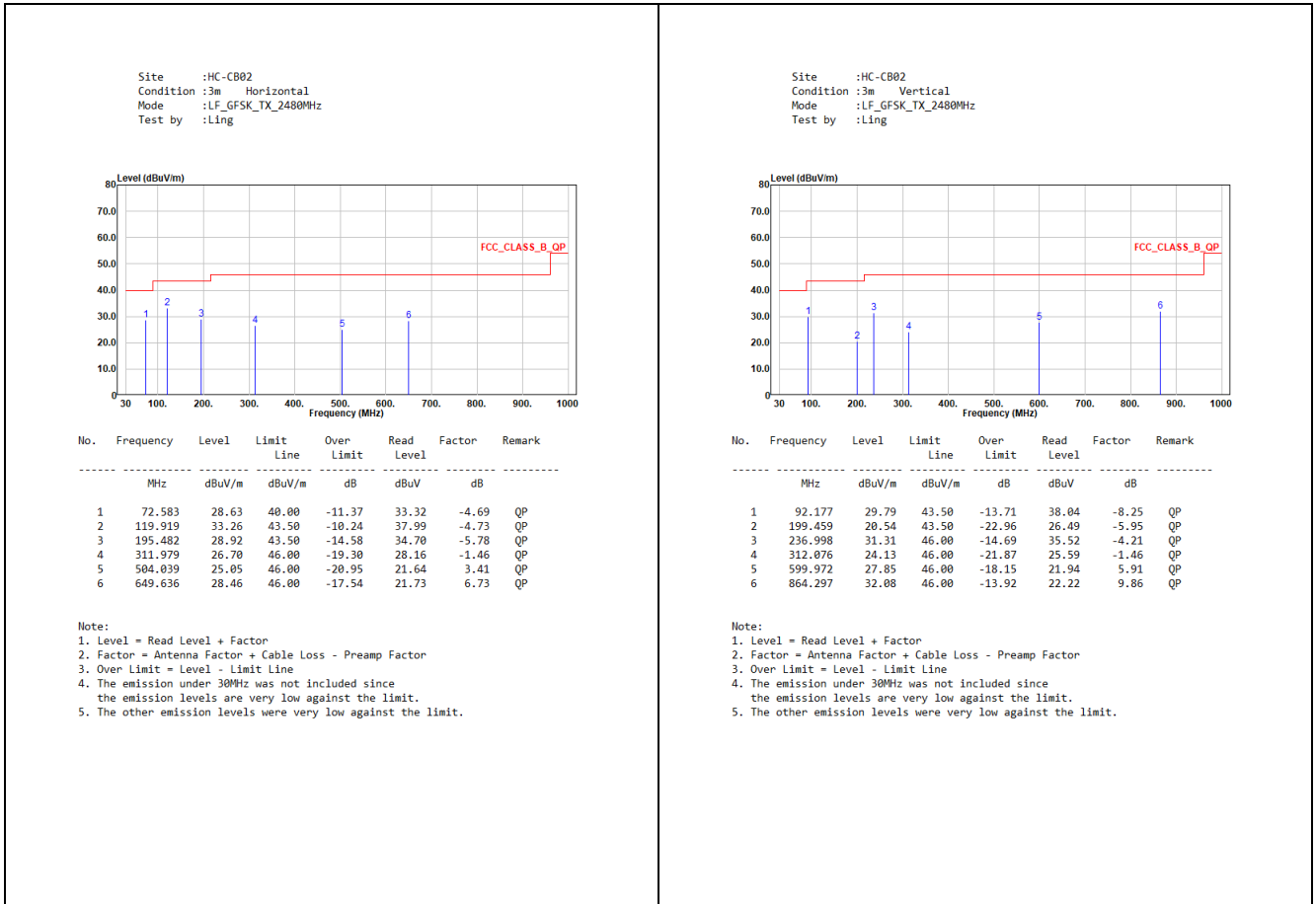

Mode 2: Transmit – power by charging

Site :HC-CB02  
 Condition :3m Horizontal  
 Mode :LF\_GFSK\_TX\_2480MHz  
 Test by :Ling

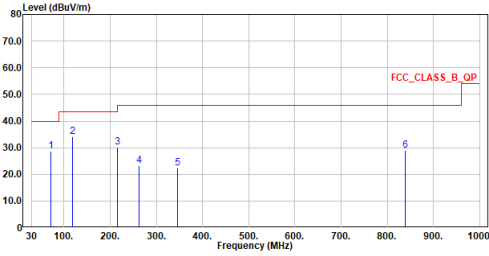

No.	Frequency MHz	Level dBuV/m	Limit dBuV/m	Over Limit dB	Read Level dBuV	Factor dB	Remark
1	71.516	28.55	40.00	-11.45	33.12	-4.57	QP
2	117.737	34.04	43.50	-9.46	39.10	-5.06	QP
3	215.998	30.32	43.50	-13.18	36.43	-6.11	QP
4	262.412	23.11	46.00	-22.89	26.47	-3.36	QP
5	346.075	22.38	46.00	-23.62	23.28	-0.90	QP
6	839.077	28.88	46.00	-17.12	19.81	9.07	QP

Note:  
 1. Level = Read Level + Factor  
 2. Factor = Antenna Factor + Cable Loss - Preamp Factor  
 3. Over Limit = Level - Limit Line  
 4. The emission under 30MHz was not included since the emission levels are very low against the limit.  
 5. The other emission levels were very low against the limit.

Site :HC-CB02  
 Condition :3m Vertical  
 Mode :LF\_GFSK\_TX\_2480MHz  
 Test by :Ling

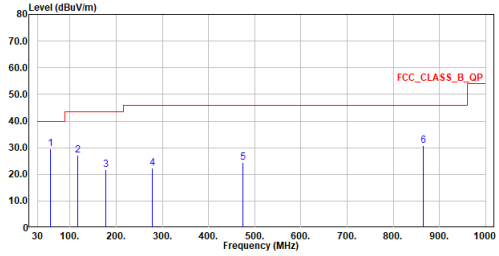

No.	Frequency MHz	Level dBuV/m	Limit dBuV/m	Over Limit dB	Read Level dBuV	Factor dB	Remark
1	56.869	29.49	40.00	-10.51	32.08	-2.59	QP
2	116.427	27.15	43.50	-16.35	32.29	-5.14	QP
3	177.343	21.60	43.50	-21.90	25.56	-3.96	QP
4	277.641	22.35	46.00	-23.65	24.81	-2.46	QP
5	473.581	24.47	46.00	-21.53	21.79	2.68	QP
6	864.637	30.67	46.00	-15.33	21.32	9.35	QP

Note:  
 1. Level = Read Level + Factor  
 2. Factor = Antenna Factor + Cable Loss - Preamp Factor  
 3. Over Limit = Level - Limit Line  
 4. The emission under 30MHz was not included since the emission levels are very low against the limit.  
 5. The other emission levels were very low against the limit.

### 4.6. Test Result of Radiated Emissions (1 GHz ~ 10<sup>th</sup> Harmonic)

Mode 1: Transmit – power by host equipment

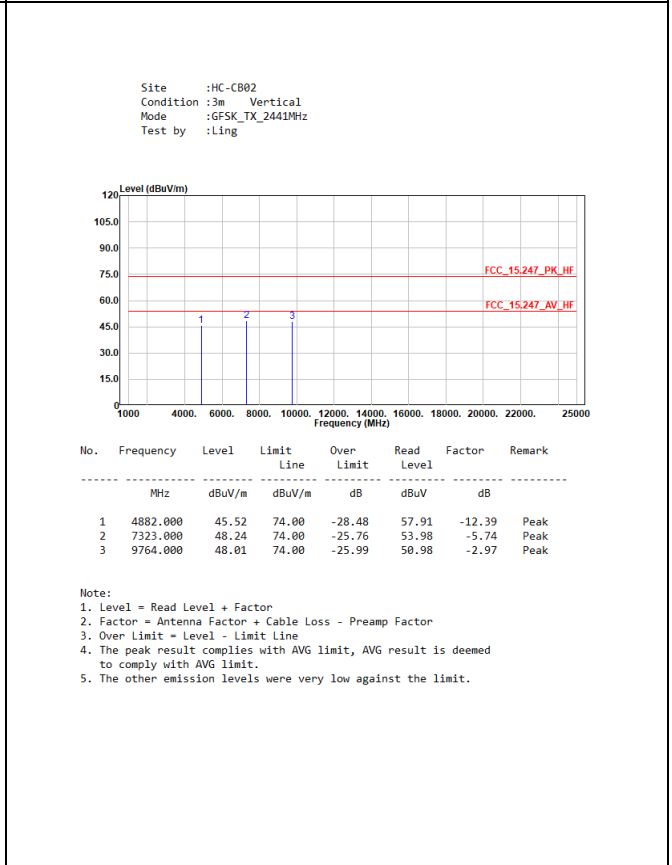
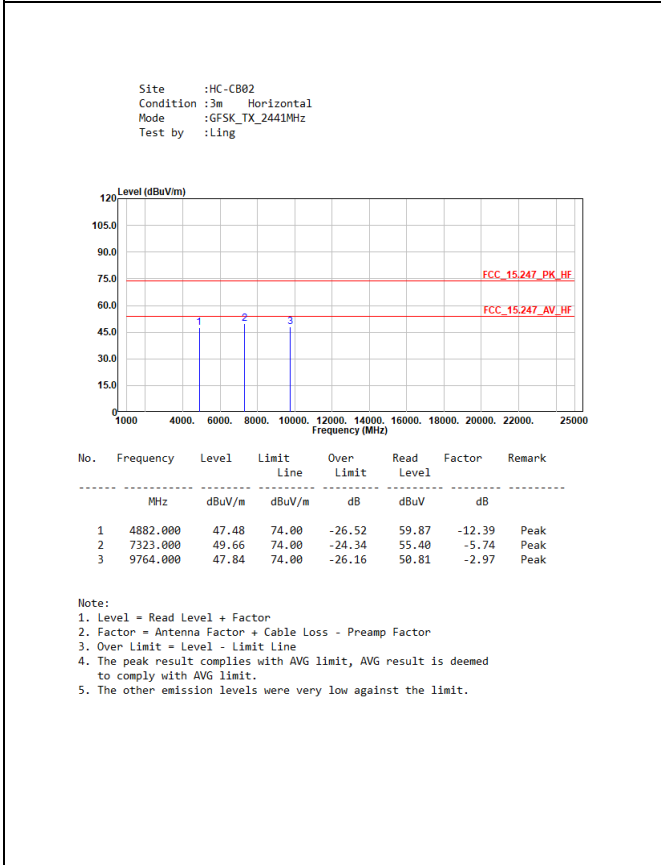
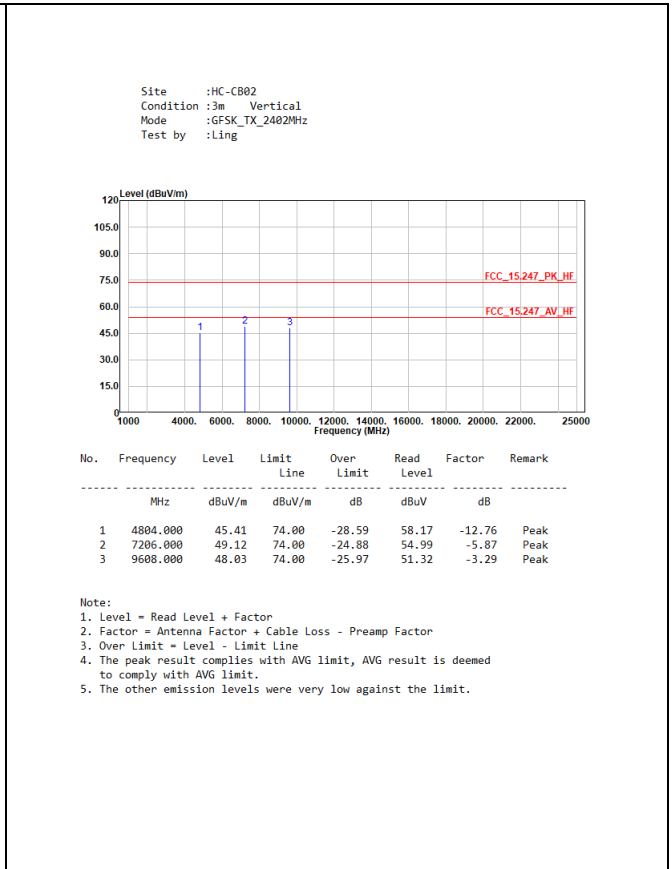
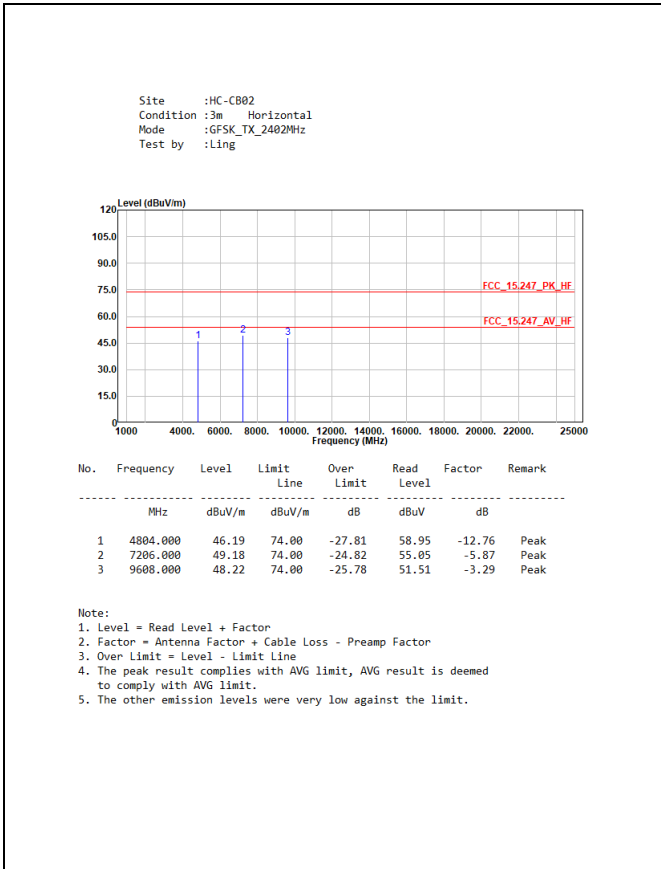

Site :HC-CB02  
 Condition :3m Horizontal  
 Mode :GFSK\_TX\_2480MHz  
 Test by :Ling

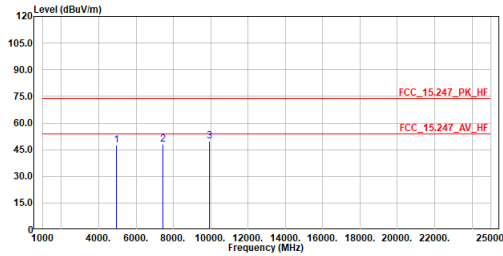

No.	Frequency MHz	Level dBuV/m	Limit Line dBuV/m	Over Limit dB	Read Level dBuV	Factor dB	Remark
1	4960.000	47.49	74.00	-26.51	59.52	-12.03	Peak
2	7440.000	48.07	74.00	-25.93	53.70	-5.63	Peak
3	9920.000	49.88	74.00	-24.12	52.50	-2.62	Peak

Note:  
 1. Level = Read Level + Factor  
 2. Factor = Antenna Factor + Cable Loss - Preamp Factor  
 3. Over Limit = Level - Limit Line  
 4. The peak result complies with AVG limit, AVG result is deemed to comply with AVG limit.  
 5. The other emission levels were very low against the limit.

Site :HC-CB02  
 Condition :3m Vertical  
 Mode :GFSK\_TX\_2480MHz  
 Test by :Ling

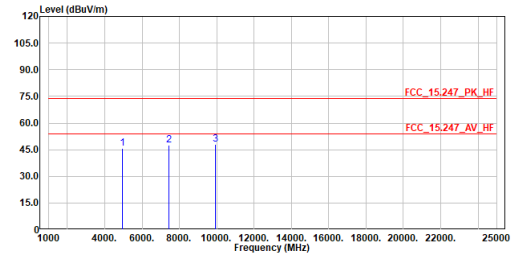

No.	Frequency MHz	Level dBuV/m	Limit Line dBuV/m	Over Limit dB	Read Level dBuV	Factor dB	Remark
1	4960.000	45.73	74.00	-28.27	57.76	-12.03	Peak
2	7440.000	47.77	74.00	-26.23	53.40	-5.63	Peak
3	9920.000	48.20	74.00	-25.80	50.82	-2.62	Peak

Note:  
 1. Level = Read Level + Factor  
 2. Factor = Antenna Factor + Cable Loss - Preamp Factor  
 3. Over Limit = Level - Limit Line  
 4. The peak result complies with AVG limit, AVG result is deemed to comply with AVG limit.  
 5. The other emission levels were very low against the limit.

Site :HC-CB02  
 Condition :3m Horizontal  
 Mode :8DPSK\_TX\_2402MHz  
 Test by :Ling

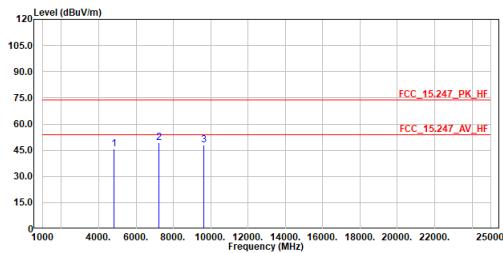

No.	Frequency MHz	Level dBuV/m	Limit Line dBuV/m	Over Limit dB	Read Level dBuV	Factor dB	Remark
1	4804.000	45.63	74.00	-28.37	58.39	-12.76	Peak
2	7206.000	49.24	74.00	-24.76	55.11	-5.87	Peak
3	9608.000	47.94	74.00	-26.06	51.23	-3.29	Peak

Note:  
 1. Level = Read Level + Factor  
 2. Factor = Antenna Factor + Cable Loss - Preamp Factor  
 3. Over Limit = Level - Limit Line  
 4. The peak result complies with AVG limit, AVG result is deemed to comply with AVG limit.  
 5. The other emission levels were very low against the limit.

Site :HC-CB02  
 Condition :3m Vertical  
 Mode :8DPSK\_TX\_2402MHz  
 Test by :Ling

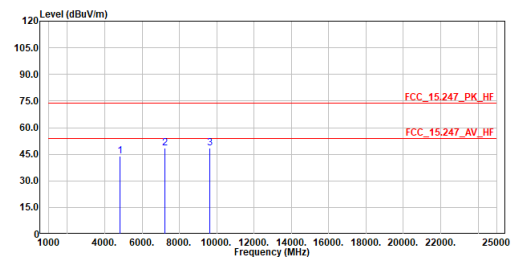

No.	Frequency MHz	Level dBuV/m	Limit Line dBuV/m	Over Limit dB	Read Level dBuV	Factor dB	Remark
1	4804.000	43.74	74.00	-30.26	56.50	-12.76	Peak
2	7206.000	48.54	74.00	-25.46	54.41	-5.87	Peak
3	9608.000	48.27	74.00	-25.73	51.56	-3.29	Peak

Note:  
 1. Level = Read Level + Factor  
 2. Factor = Antenna Factor + Cable Loss - Preamp Factor  
 3. Over Limit = Level - Limit Line  
 4. The peak result complies with AVG limit, AVG result is deemed to comply with AVG limit.  
 5. The other emission levels were very low against the limit.

Site :HC-CB02  
 Condition :3m Horizontal  
 Mode :8DPSK\_TX\_2441MHz  
 Test by :Ling

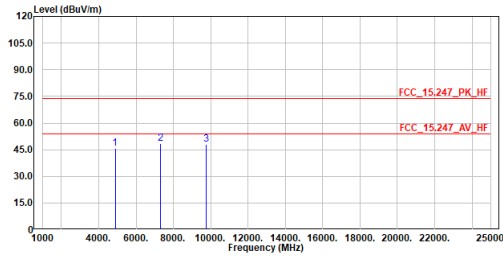

No.	Frequency MHz	Level dBuV/m	Limit Line dBuV/m	Over Limit dB	Read Level dBuV	Factor dB	Remark
1	4882.000	45.54	74.00	-28.46	57.93	-12.39	Peak
2	7323.000	48.48	74.00	-25.52	54.22	-5.74	Peak
3	9764.000	48.11	74.00	-25.89	51.08	-2.97	Peak

Note:  
 1. Level = Read Level + Factor  
 2. Factor = Antenna Factor + Cable Loss - Preamp Factor  
 3. Over Limit = Level - Limit Line  
 4. The peak result complies with AVG limit, AVG result is deemed to comply with AVG limit.  
 5. The other emission levels were very low against the limit.

Site :HC-CB02  
 Condition :3m Vertical  
 Mode :8DPSK\_TX\_2441MHz  
 Test by :Ling

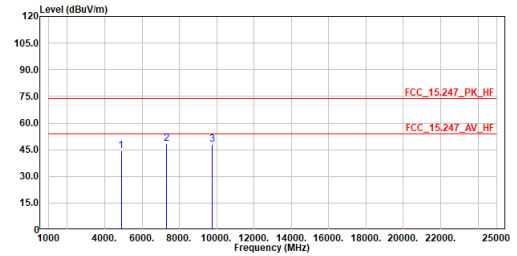

No.	Frequency MHz	Level dBuV/m	Limit Line dBuV/m	Over Limit dB	Read Level dBuV	Factor dB	Remark
1	4882.000	44.48	74.00	-29.52	56.87	-12.39	Peak
2	7323.000	48.31	74.00	-25.69	54.05	-5.74	Peak
3	9764.000	48.20	74.00	-25.80	51.17	-2.97	Peak

Note:  
 1. Level = Read Level + Factor  
 2. Factor = Antenna Factor + Cable Loss - Preamp Factor  
 3. Over Limit = Level - Limit Line  
 4. The peak result complies with AVG limit, AVG result is deemed to comply with AVG limit.  
 5. The other emission levels were very low against the limit.

Site :HC-CB02  
 Condition :3m Horizontal  
 Mode :8DPSK\_TX\_2480MHz  
 Test by :Ling

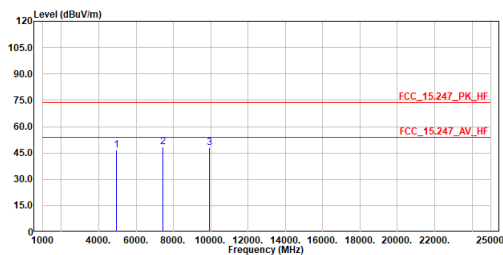

No.	Frequency MHz	Level dBuV/m	Limit Line dBuV/m	Over Limit dB	Read Level dBuV	Factor dB	Remark
1	4960.000	46.49	74.00	-27.51	58.52	-12.03	Peak
2	7440.000	48.28	74.00	-25.72	53.91	-5.63	Peak
3	9920.000	48.04	74.00	-25.96	50.66	-2.62	Peak

Note:  
 1. Level = Read Level + Factor  
 2. Factor = Antenna Factor + Cable Loss - Preamp Factor  
 3. Over Limit = Level - Limit Line  
 4. The peak result complies with AVG limit, AVG result is deemed to comply with AVG limit.  
 5. The other emission levels were very low against the limit.

Site :HC-CB02  
 Condition :3m Vertical  
 Mode :8DPSK\_TX\_2480MHz  
 Test by :Ling

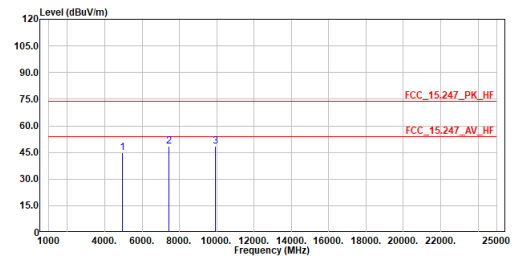

No.	Frequency MHz	Level dBuV/m	Limit Line dBuV/m	Over Limit dB	Read Level dBuV	Factor dB	Remark
1	4960.000	44.87	74.00	-29.13	56.90	-12.03	Peak
2	7440.000	48.45	74.00	-25.55	54.08	-5.63	Peak
3	9920.000	48.25	74.00	-25.75	50.87	-2.62	Peak

Note:  
 1. Level = Read Level + Factor  
 2. Factor = Antenna Factor + Cable Loss - Preamp Factor  
 3. Over Limit = Level - Limit Line  
 4. The peak result complies with AVG limit, AVG result is deemed to comply with AVG limit.  
 5. The other emission levels were very low against the limit.

## 5. Antenna Port Conducted Emission

### 5.1. Test Setup

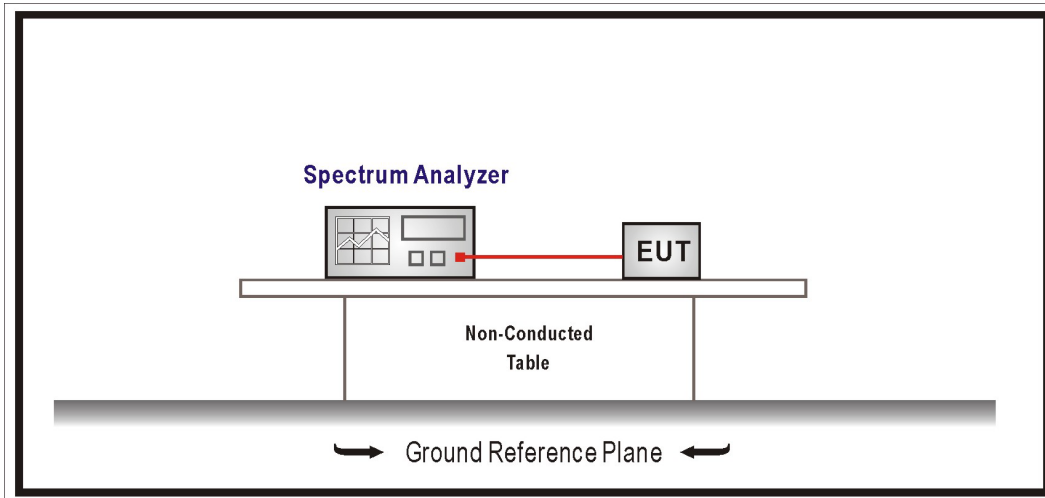

### 5.2. Test Limit

For FCC:

In any 100 kHz bandwidth outside the frequency band in which the spread spectrum intentional radiator is operating, the radio frequency power that is produced by the intentional radiator shall be at least 20 dB below that in the 100 kHz bandwidth within the band that contains the highest level of the desired power, based on an RF conducted or radiated measurement. Attenuation below the general limit specified in Section 15.209(a) is not required. In addition, radiated emissions which fall in the restricted bands, as defined in Section 15.205(a), must also comply with the radiated emission limit specified in Section 15.209(a) (see Section 15.205(c)).

For ISSED:

According to RSS-247 Issue 2. In any 100 kHz bandwidth outside the frequency band in which the spread spectrum or digitally modulated device is operating, the radio frequency power that is produced shall be at least 20 dB below that in the 100 kHz bandwidth within the band that contains the highest level of the desired power, based on either an RF conducted measurement, provided the transmitter demonstrates compliance with the peak conducted power limit.

### 5.3. Test Procedure

The EUT was setup according to ANSI C63.10: 2013 and tested according to FHSS test procedure of FCC KDB 558074 D01 v05r02 for compliance to FCC 47CFR 15.247 / RSS-247 issue 2.

### 5.4. Test Specification

According to FCC Part 15 Subpart C Paragraph 15.247 / IC RSS-247 Issue 2.



### 5.5. Test Result of Antenna Port Conducted Emission

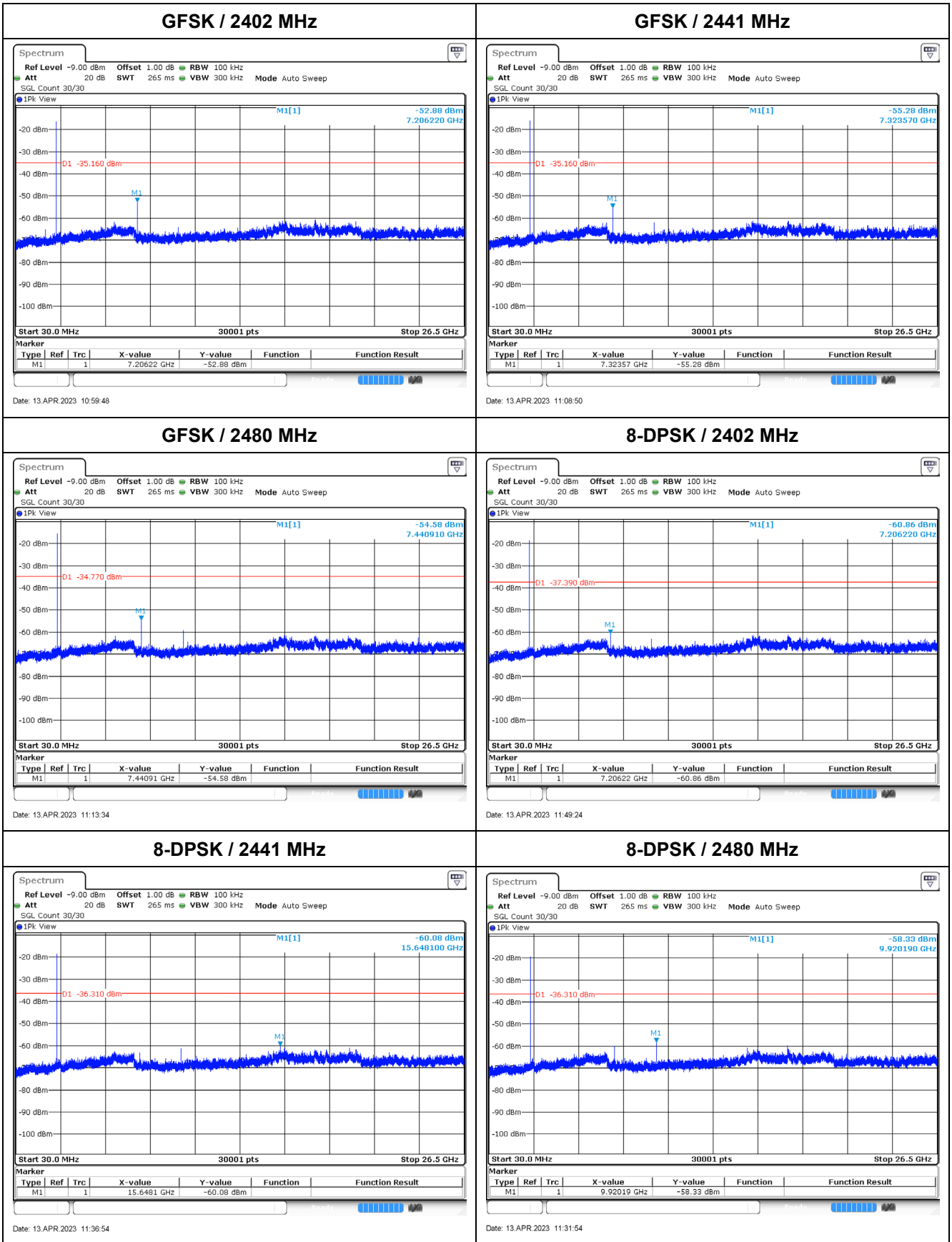

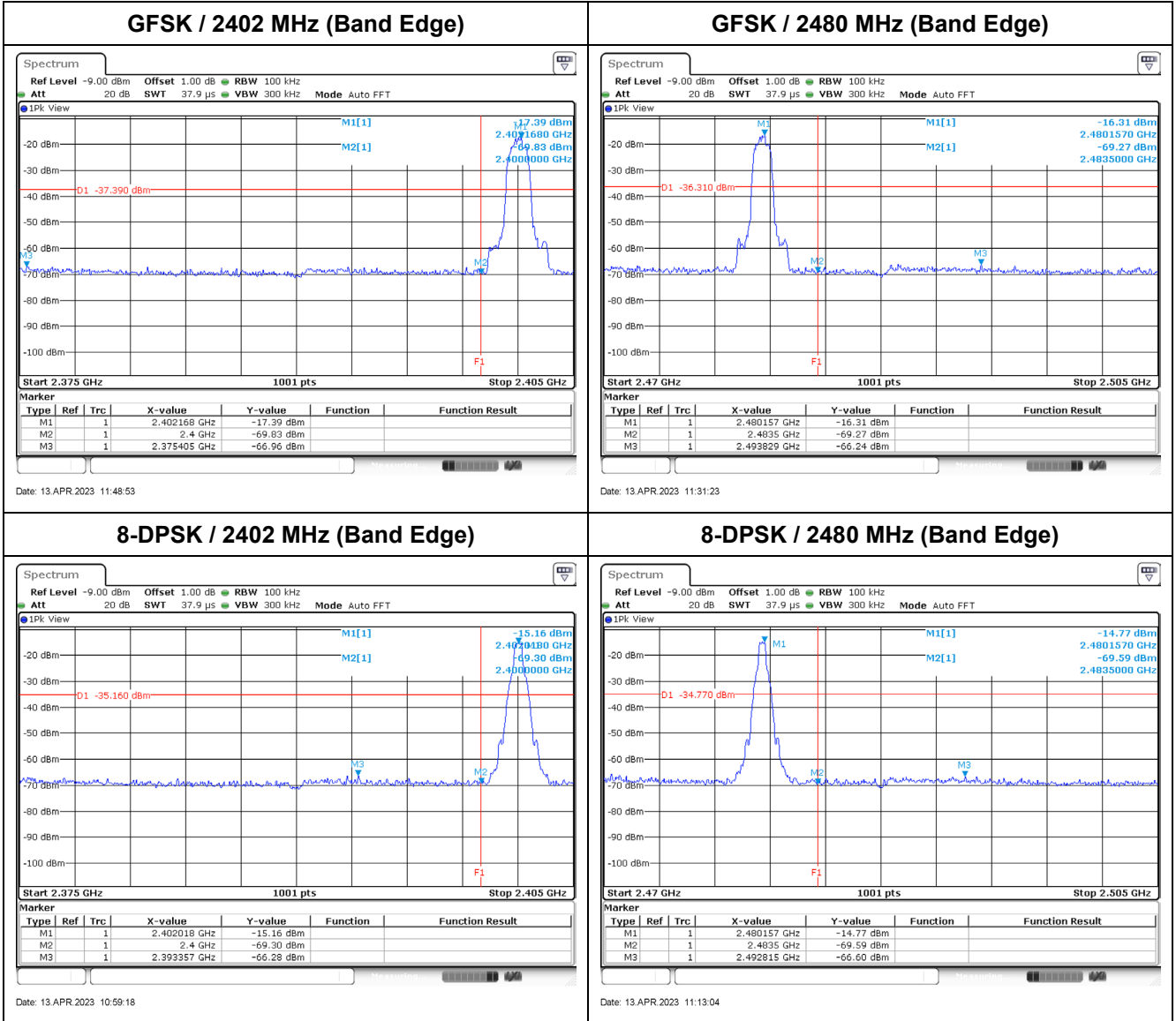

## 6. Radiated Emission Band Edge

### 6.1. Test Setup

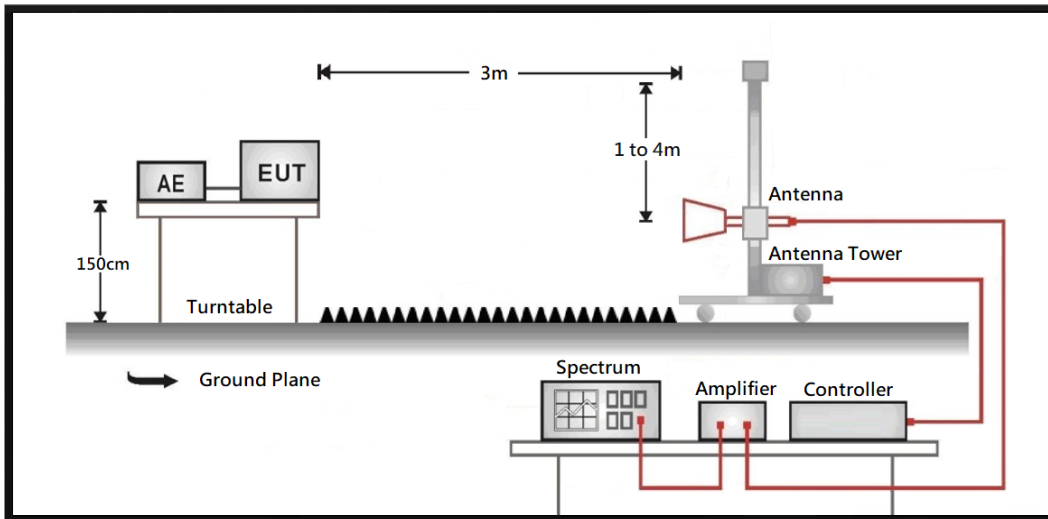

## 6.2. Test Limit

For FCC:

Emissions radiated outside of the specified frequency bands, except for harmonics, shall be attenuated by at least 20 dB below the level of the fundamental or to the general radiated emission limit in paragraph 15.209, whichever is the lesser attenuation.

Frequency (MHz)	Field strength (uV/m)	Field strength (dBuV/m)	Measurement distance (m)
30 - 88	100	40	3
88 - 216	150	43.5	3
216 - 960	200	46	3
Above 960	500	54	3

Remarks:

1. Field strength (dBuV/m) = 20 log Field strength (uV/m)
2. In the Above Table, the tighter limit applies at the band edges.
3. Distance refers to the distance in meters between the measuring instrument antenna and the closed point of any part of the device or system.

For ISED:

In any 100 kHz bandwidth outside the operating frequency bands, between 30 MHz and 5 times the carrier frequency, the unwanted emission spectral density shall be either at least 20 dB below the inband spectral density, or shall not exceed the levels specified in RSS-Gen Issue 5 Section 8.9, whichever is the less stringent. Note. For frequency hopping systems, the inband density  $S_i$  shall be measured with the hopping sequence stopped at lowest channel and highest channel in turn, as with the hopping running normally. The 20 dB shall be with reference to the lowest of the three  $S_i$  values.

Frequency (MHz)	Field strength (uV/m)	Field strength (dBuV/m)	Measurement distance (m)
30 - 88	100	40	3
88 - 216	150	43.5	3
216 - 960	200	46	3
Above 960	500	54	3

Remarks:

1. Field strength (dBuV/m) = 20 log Field strength (uV/m)
2. In the Above Table, the tighter limit applies at the band edges.
3. Distance refers to the distance in meters between the measuring instrument antenna and the closed point of any part of the device or system.

### 6.3. Test Procedure

For FCC:

The EUT was setup according to ANSI C63.10: 2013 and tested according to the FCC KDB 558074 D01 v05r02 for compliance to FCC 47CFR 15.247 requirements.

The EUT and its simulators are placed on a turn table which is 1.5 meter above ground. The turn table can rotate 360 degrees to determine the position of the maximum emission level. The antenna can move up and down between 1 meter and 4 meters to find out the maximum emission level.

Both horizontal and vertical polarization of the antenna are set on measurement. In order to find the maximum emission, all of the interface cables must be manipulated according to ANSI C63.10: 2013 on radiated measurement.

For ISSED:

The EUT and its simulators are placed on a turn table which is 1.5 meter above ground. The turn table can rotate 360 degrees to determine the position of the maximum emission level. The EUT was positioned such that the distance from antenna to the EUT was 3 meters.

The antenna can move up and down between 1 meter and 4 meters to find out the maximum emission level. Both horizontal and vertical polarization of the antenna are set on measurement. In order to find the maximum emission, all of the interface cables must be manipulated according to ANSI C63.10: 2013 on radiated measurement.

### 6.4. Test Specification

According to FCC Part 15 Subpart C Paragraph 15.247 / IC RSS-247 Issue 2.

## 6.5. Test Result of Radiated Emission Band Edge

### Band Edge

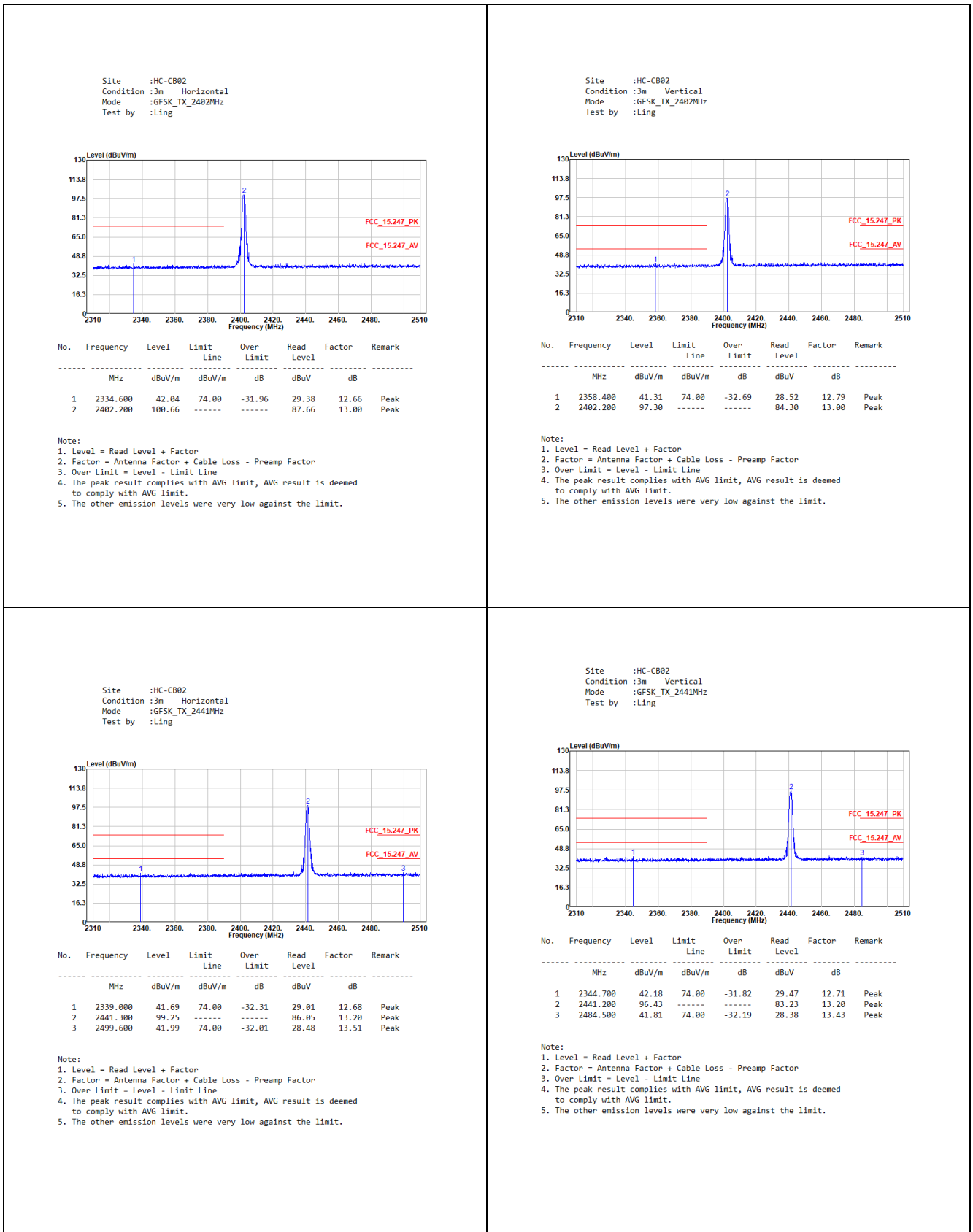

Site :HC-CB02  
 Condition :3m Horizontal  
 Mode :GFSK\_TX\_2480MHz  
 Test by :Ling

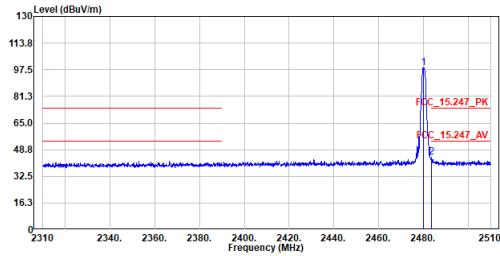

No.	Frequency	Level	Limit	Over	Read	Factor	Remark
	MHz	dBuV/m	dBuV/m	dB	dBuV	dB	
1	2480.100	98.80	-----	-----	85.40	13.40	Peak
2	2483.600	44.39	74.00	-29.61	30.96	13.43	Peak

Note:  
 1. Level = Read Level + Factor  
 2. Factor = Antenna Factor + Cable Loss - Preamp Factor  
 3. Over Limit = Level - Limit Line  
 4. The peak result complies with AVG limit, AVG result is deemed to comply with AVG limit.  
 5. The other emission levels were very low against the limit.

Site :HC-CB02  
 Condition :3m Vertical  
 Mode :GFSK\_TX\_2480MHz  
 Test by :Ling

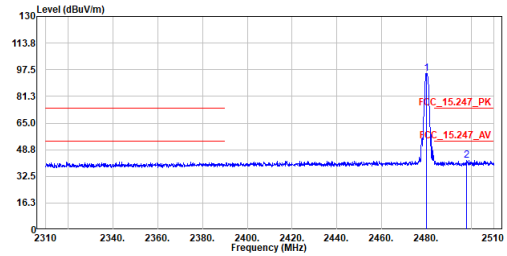

No.	Frequency	Level	Limit	Over	Read	Factor	Remark
	MHz	dBuV/m	dBuV/m	dB	dBuV	dB	
1	2479.900	95.24	-----	-----	81.84	13.40	Peak
2	2497.800	42.39	74.00	-31.61	28.88	13.51	Peak

Note:  
 1. Level = Read Level + Factor  
 2. Factor = Antenna Factor + Cable Loss - Preamp Factor  
 3. Over Limit = Level - Limit Line  
 4. The peak result complies with AVG limit, AVG result is deemed to comply with AVG limit.  
 5. The other emission levels were very low against the limit.

Site :HC-CB02  
 Condition :3m Horizontal  
 Mode :8DPSK\_TX\_2402MHz  
 Test by :Ling

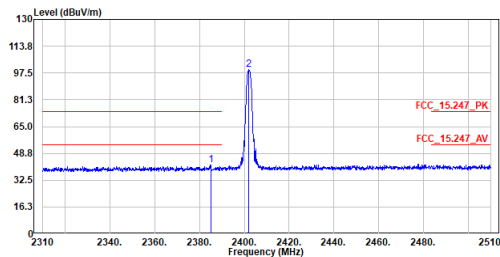

No.	Frequency	Level	Limit	Over	Read	Factor	Remark
	MHz	dBuV/m	dBuV/m	dB	dBuV	dB	
1	2385.000	41.83	74.00	-32.17	28.91	12.92	Peak
2	2402.100	99.42	-----	-----	86.42	13.00	Peak

Note:  
 1. Level = Read Level + Factor  
 2. Factor = Antenna Factor + Cable Loss - Preamp Factor  
 3. Over Limit = Level - Limit Line  
 4. The peak result complies with AVG limit, AVG result is deemed to comply with AVG limit.  
 5. The other emission levels were very low against the limit.

Site :HC-CB02  
 Condition :3m Vertical  
 Mode :8DPSK\_TX\_2402MHz  
 Test by :Ling

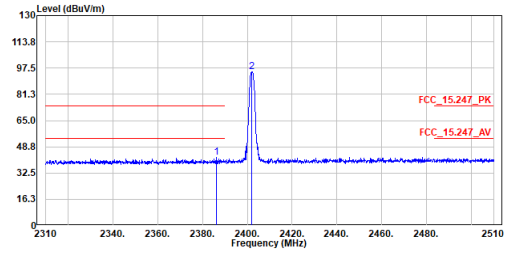

No.	Frequency	Level	Limit	Over	Read	Factor	Remark
	MHz	dBuV/m	dBuV/m	dB	dBuV	dB	
1	2386.200	42.30	74.00	-31.70	29.37	12.93	Peak
2	2402.000	95.22	-----	-----	82.22	13.00	Peak

Note:  
 1. Level = Read Level + Factor  
 2. Factor = Antenna Factor + Cable Loss - Preamp Factor  
 3. Over Limit = Level - Limit Line  
 4. The peak result complies with AVG limit, AVG result is deemed to comply with AVG limit.  
 5. The other emission levels were very low against the limit.

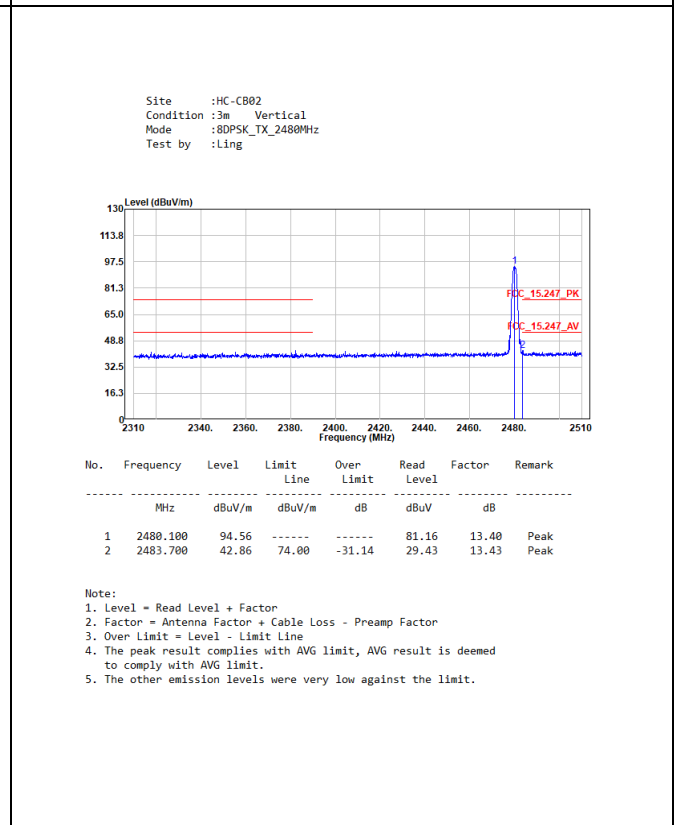
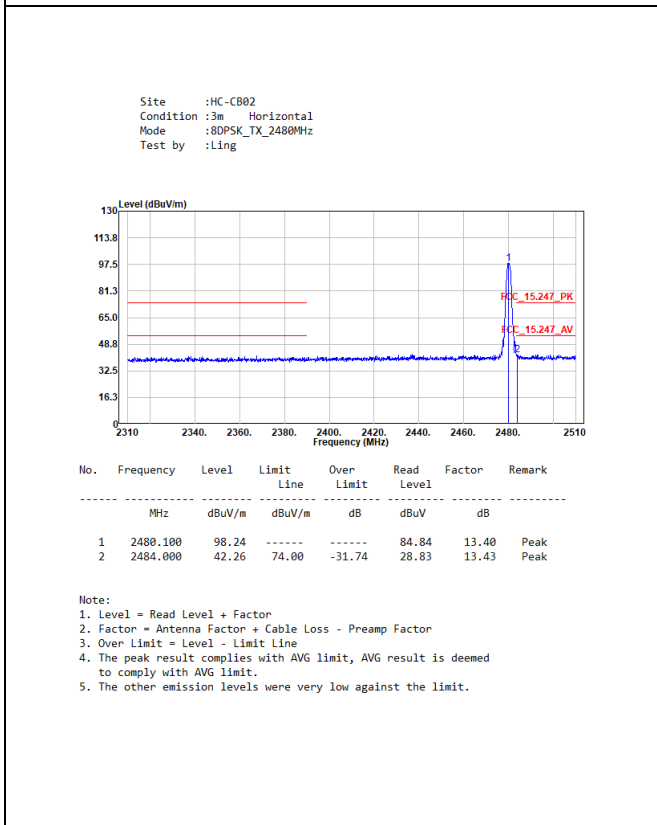
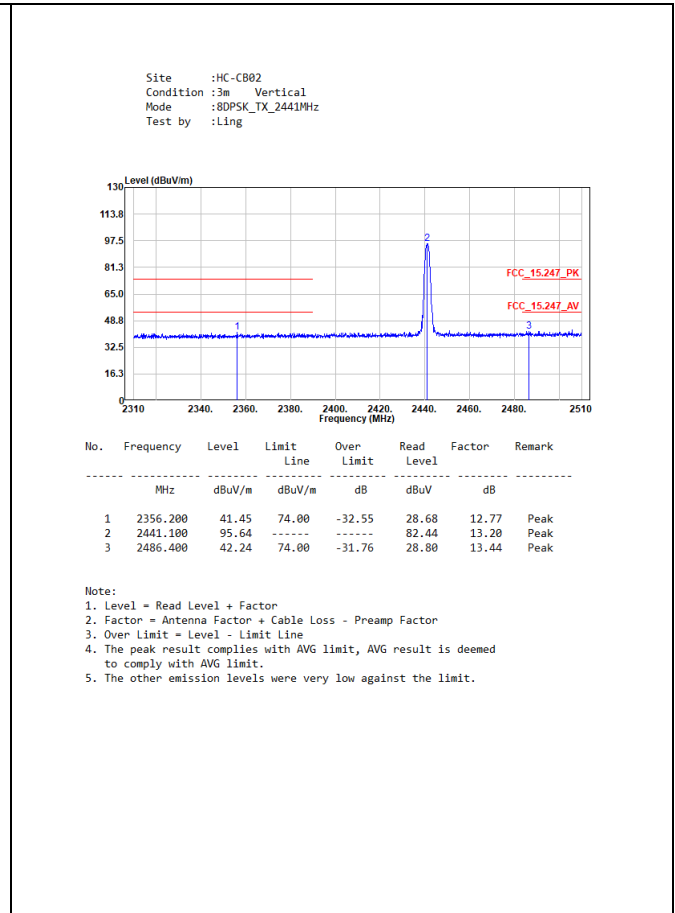
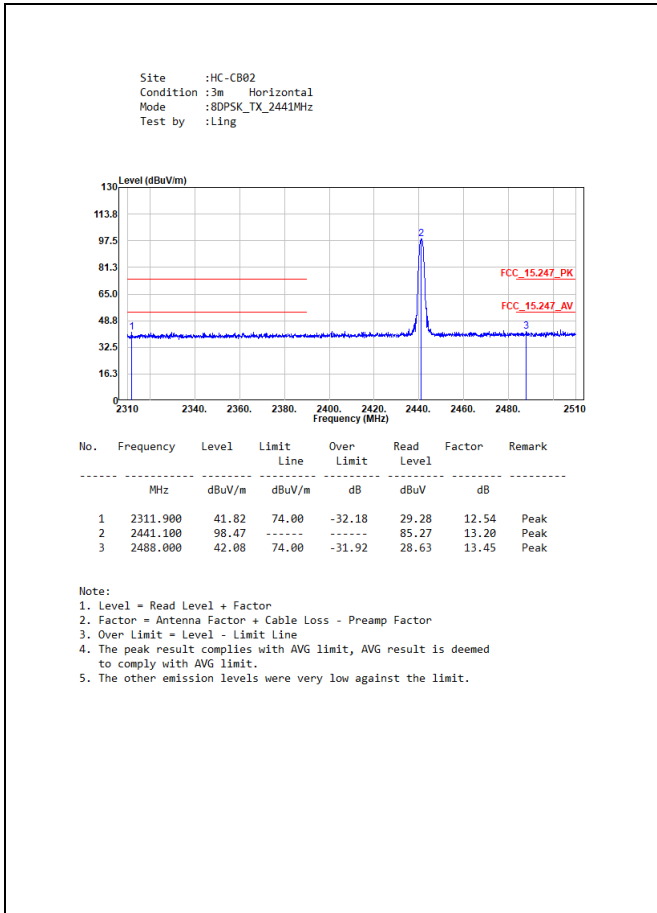



### Band Edge – Hopping

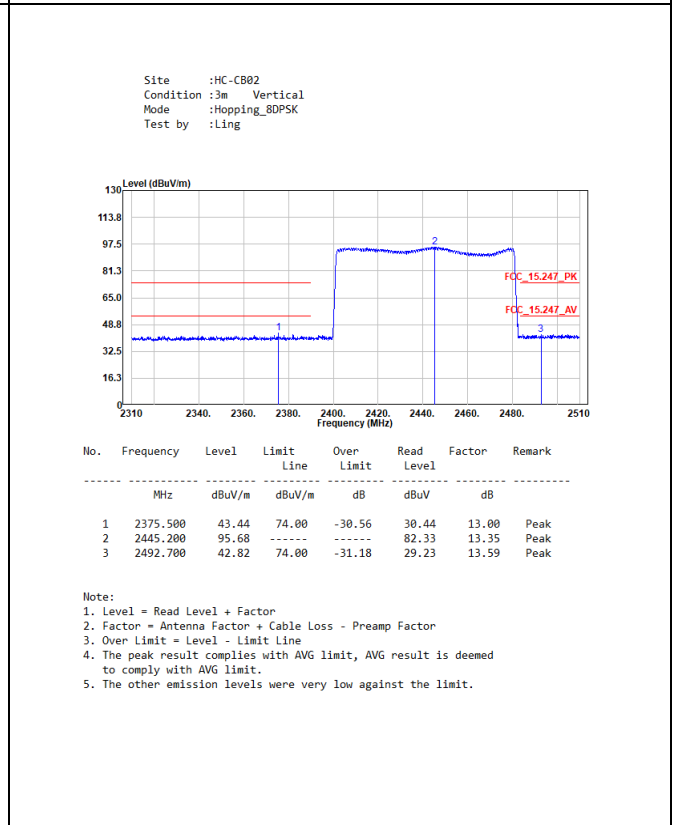
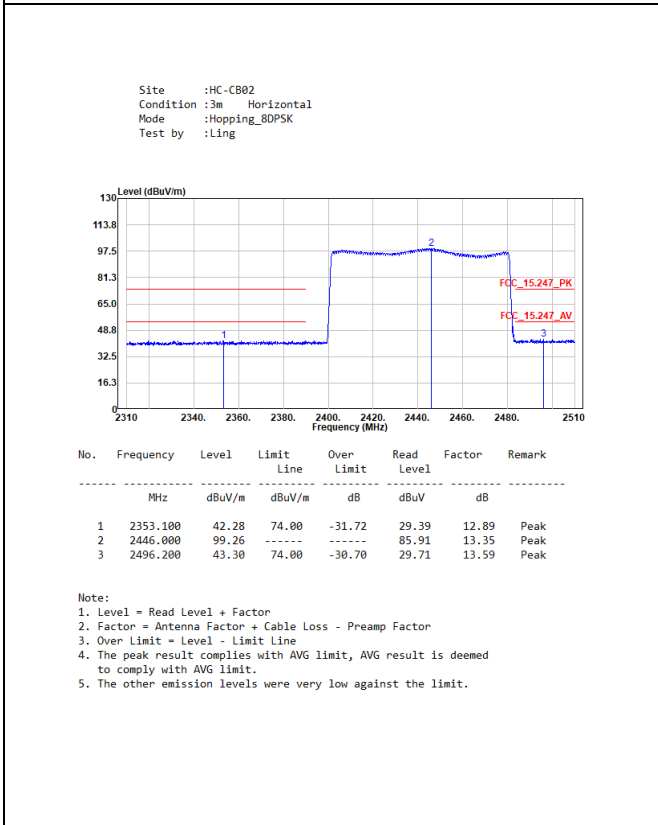
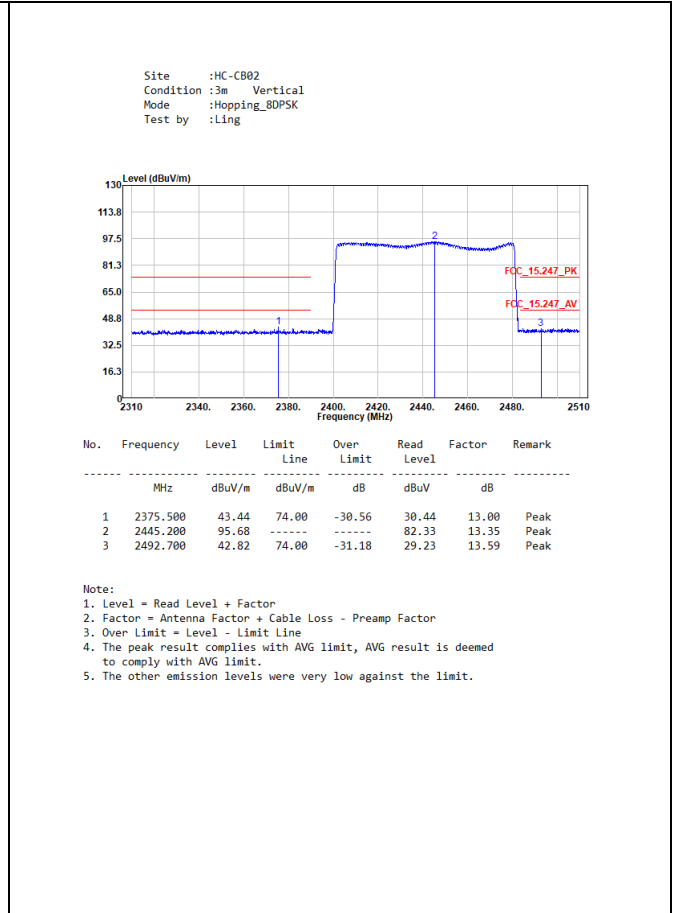
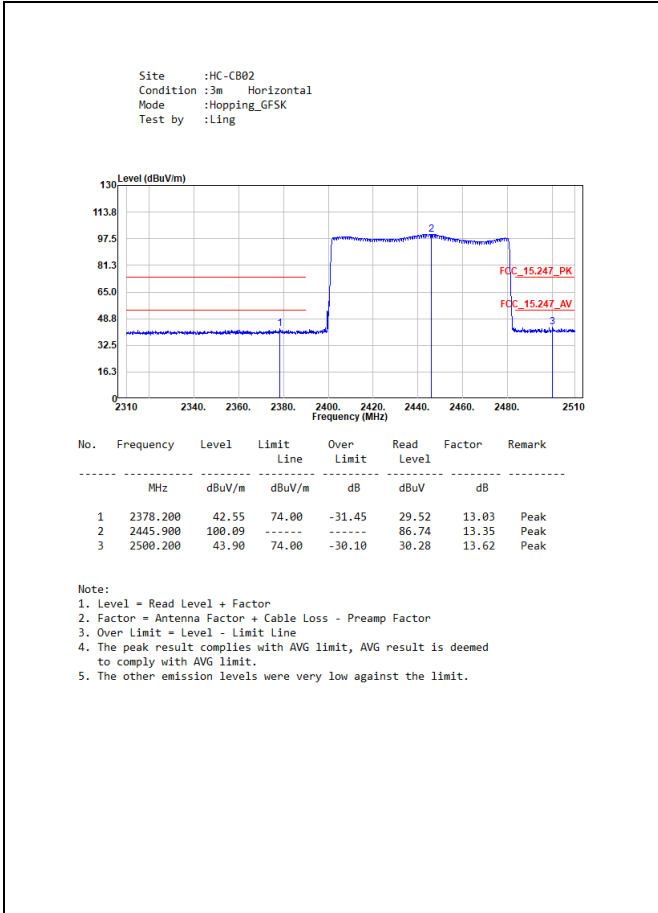

## 7. Number of Hopping Frequency

### 7.1. Test Setup

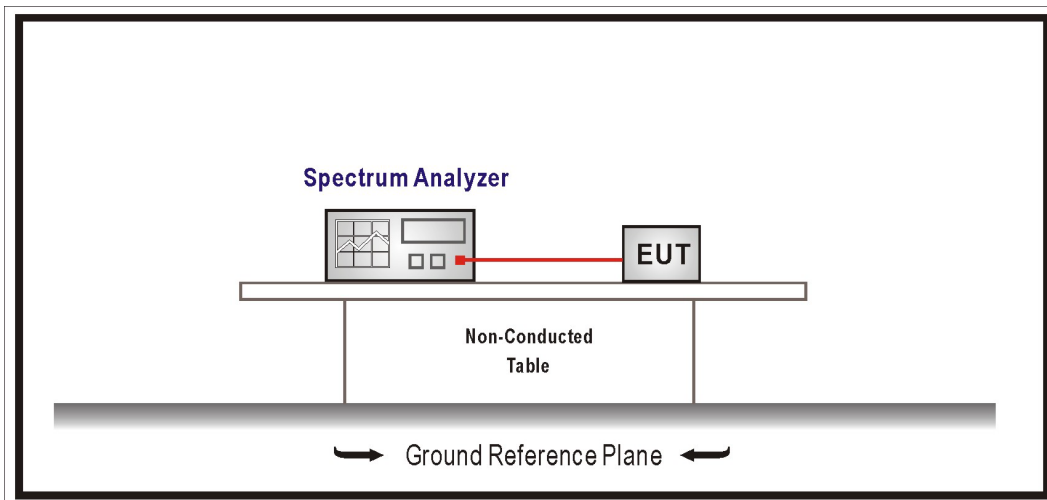

### 7.2. Test Limit

For frequency hopping systems operating in the 902 ~ 928 MHz band: if the 20 dB bandwidth of the hopping channel is less than 250 kHz, the system shall use at least 50 hopping frequencies and the average time of occupancy on any frequency shall not be greater than 0.4 seconds within a 20 second period; if the 20 dB bandwidth of the hopping channel is 250 kHz or greater, the system shall use at least 25 hopping frequencies and the average time of occupancy on any frequency shall not be greater than 0.4 seconds within a 10 second period. The maximum allowed 20 dB bandwidth of the hopping channel is 500 kHz.

Frequency hopping systems in the 2400 ~ 2483.5 MHz band shall use at least 15 channels. The average time of occupancy on any channel shall not be greater than 0.4 seconds within a period of 0.4 seconds multiplied by the number of hopping channels employed. Frequency hopping systems may avoid or suppress transmissions on a particular hopping frequency provided that a minimum of 15 channels are used.

Frequency hopping systems operating in the 5725 ~ 5850 MHz band shall use at least 75 hopping frequencies. The maximum 20 dB bandwidth of the hopping channel is 1 MHz. The average time of occupancy on any frequency shall not be greater than 0.4 seconds within a 30 second period.

### **7.3. Test Procedures**

The EUT was setup according to ANSI C63.10: 2013 and tested according to FHSS test procedure of FCC KDB 558074 D01 v05r02 for compliance to FCC 47CFR 15.247 / RSS-247 issue 2 requirements.

### **7.4. Test Specification**

According to FCC Part 15 Subpart C Paragraph 15.247 / IC RSS-247 Issue 2.

### 7.5. Test Result of Number of Hopping Frequency

Frequency Range (MHz)	Measure Level (Channels)	Limit (Channels)
2402 ~ 2480	79	≥ 75

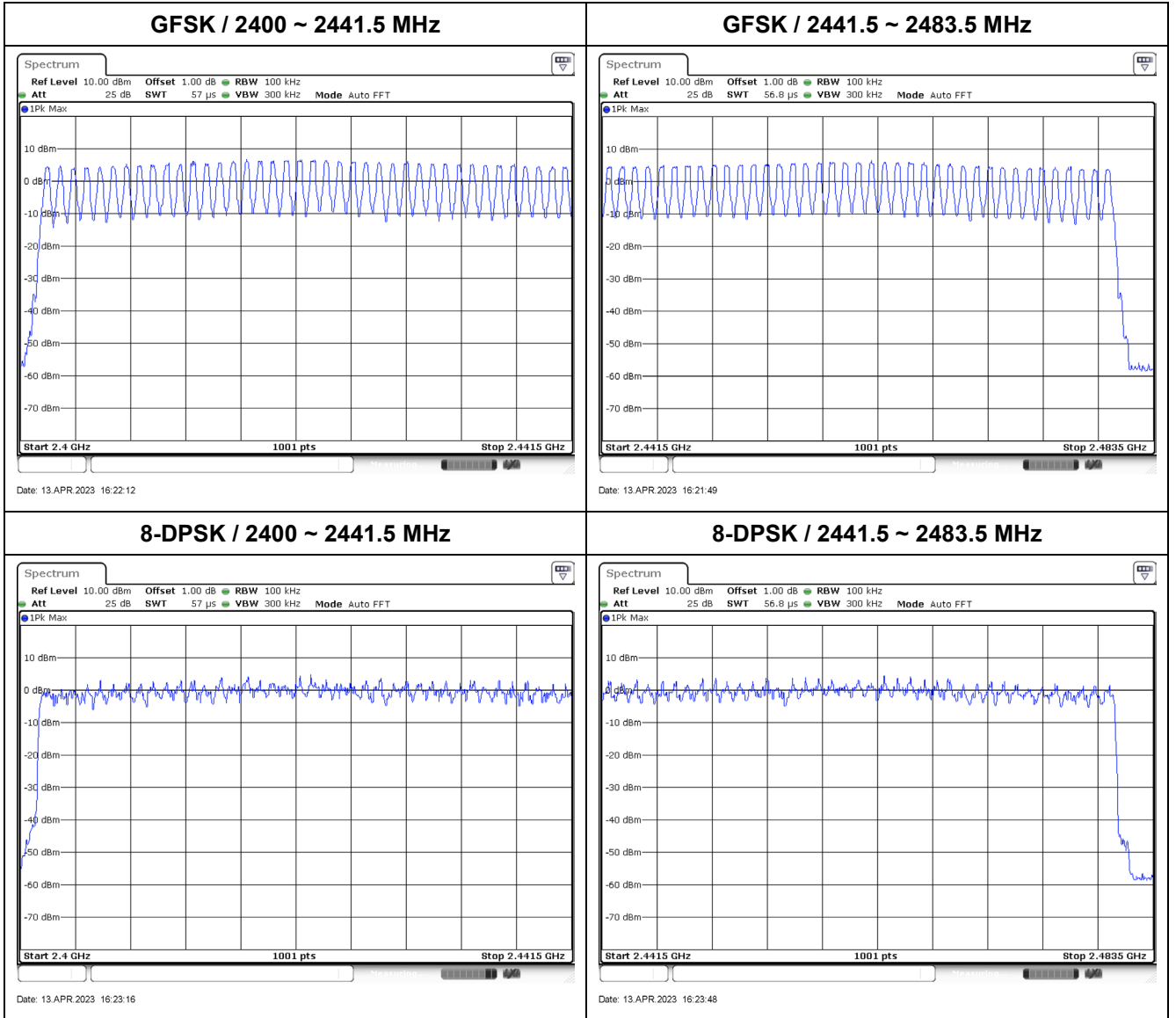

## 8. Carrier Frequency Separation

### 8.1. Test Setup

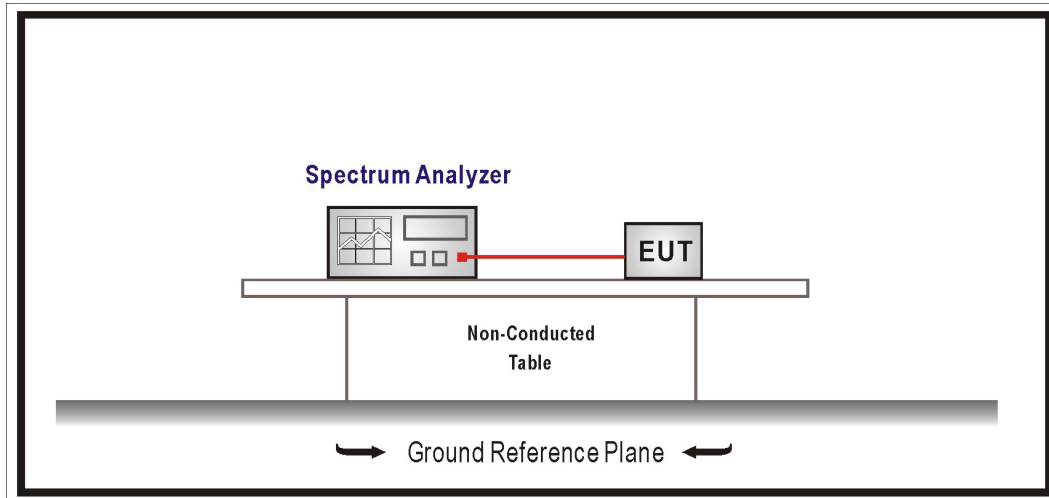

### 8.2. Test Limit

Frequency hopping systems shall have hopping channel carrier frequencies separated by a minimum of 25 kHz or the 20 dB bandwidth of the hopping channel, whichever is greater. Alternatively, frequency hopping systems operating in the 2400 ~ 2483.5 MHz band may have hopping channel carrier frequencies that are separated by 25 kHz or two-thirds of the 20 dB bandwidth of the hopping channel, whichever is greater, provided the systems operate with an Maximum Conducted Output Power no greater than 125 mW. The system shall hop to channel frequencies that are selected at the system hopping rate from a pseudo randomly ordered list of hopping frequencies. Each frequency must be used equally on the average by each transmitter. The system receivers shall have input bandwidths that match the hopping channel bandwidths of their corresponding transmitters and shall shift frequencies in synchronization with the transmitted signals.

### 8.3. Test Procedures

The EUT was setup according to ANSI C63.10: 2013 and tested according to FHSS test procedure of FCC KDB 558074 D01 v05r02 for compliance to FCC 47CFR 15.247 / RSS-247 issue 2 requirements.

### 8.4. Test Specification

According to FCC Part 15 Subpart C Paragraph 15.247 / IC RSS-247 Issue 2.

## 8.5. Test Result of Carrier Frequency Separation

Modulation	Channel	Frequency (MHz)	Measure Level (MHz)	Limit (MHz)	Result
GFSK	00	2402	1.001	$\geq 0.640$	Pass
	39	2441	0.998	$\geq 0.650$	Pass
	78	2480	1.001	$\geq 0.640$	Pass
8-DPSK	00	2402	0.998	$\geq 0.850$	Pass
	39	2441	0.998	$\geq 0.850$	Pass
	78	2480	1.001	$\geq 0.850$	Pass

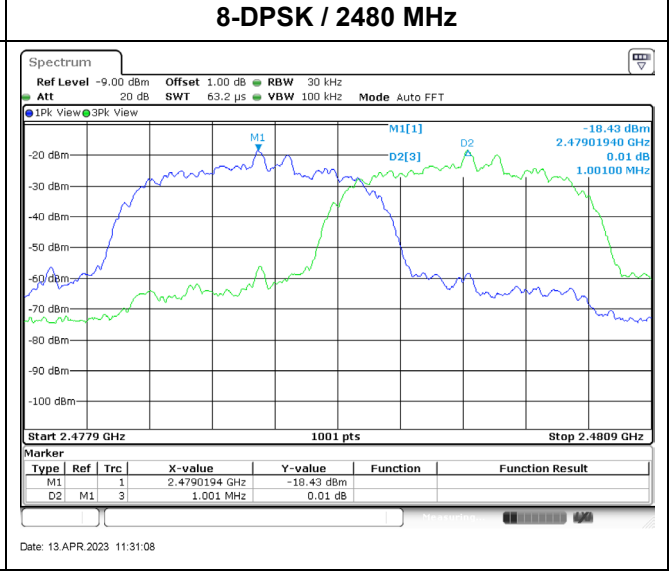
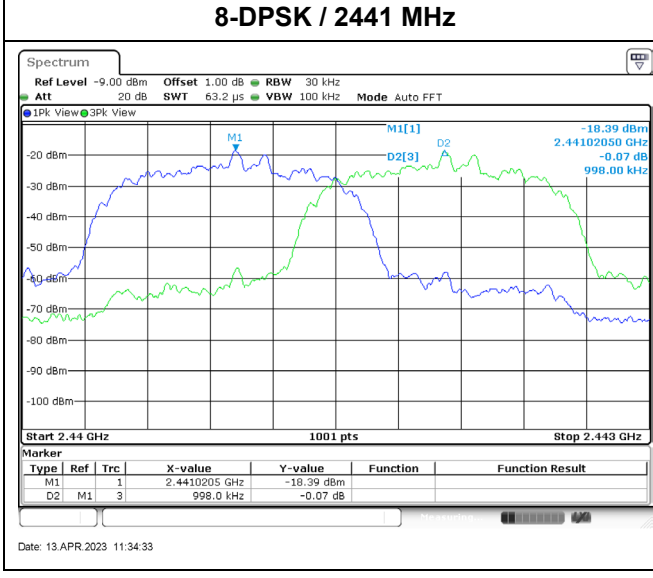
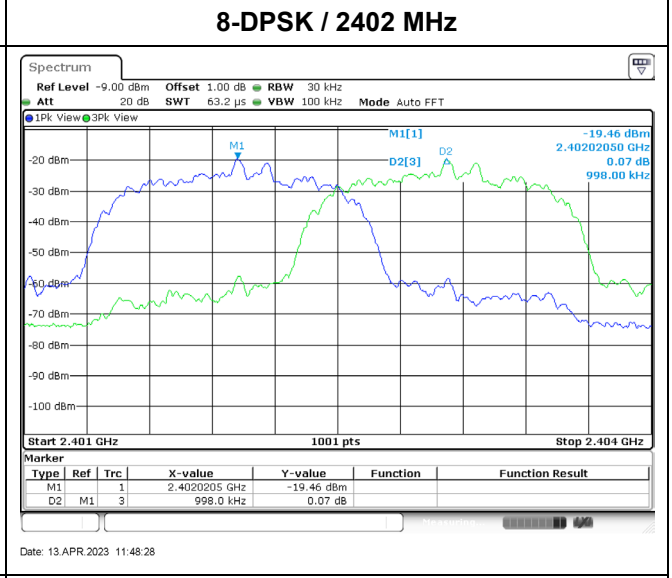
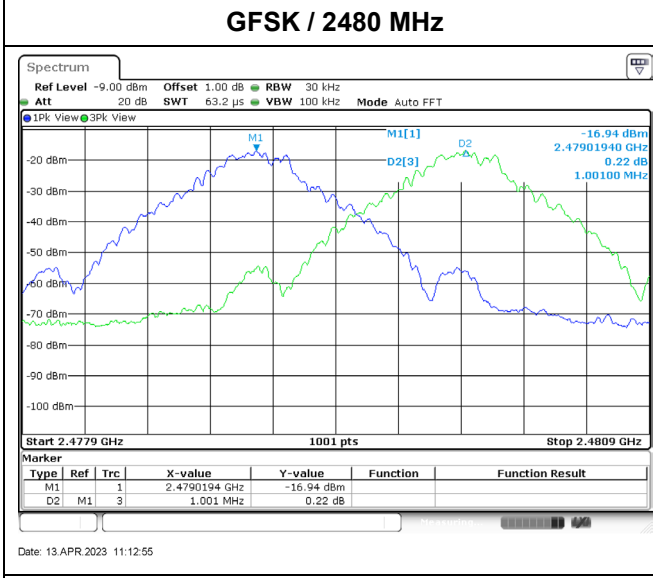
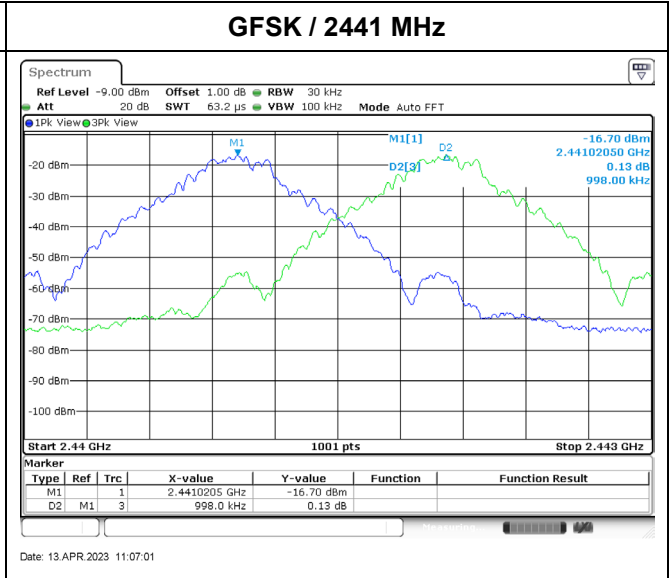
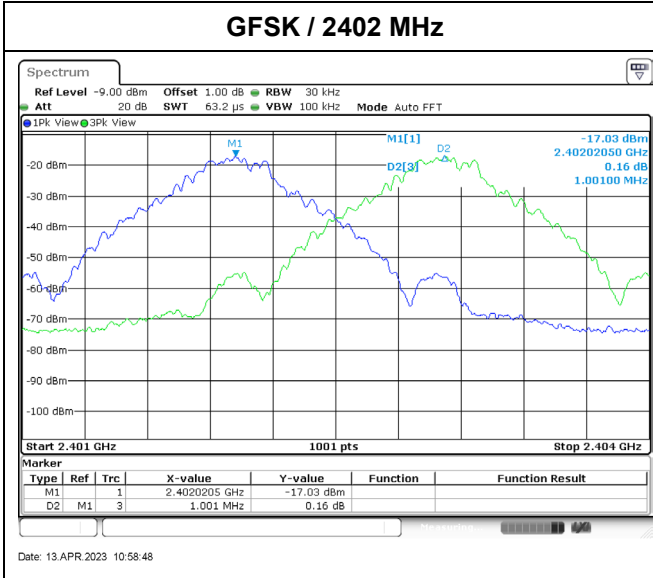

## 9. 20dB Bandwidth

### 9.1. Test Setup

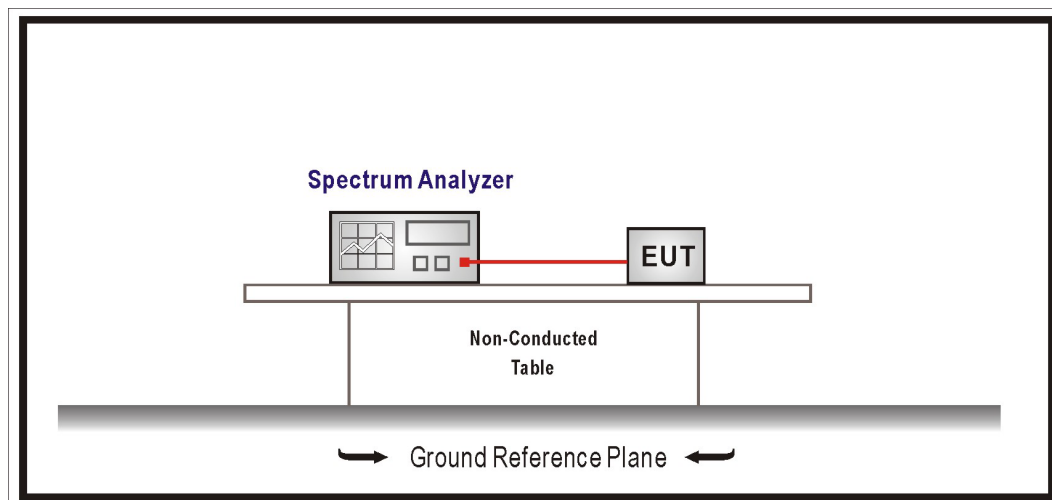

### 9.2. Test Limit

For FCC:

N/A

For ISSED:

The bandwidth of a frequency hopping channel is the -20 dB emission bandwidth, measured with the hopping stopped. The system's radio frequency (RF) bandwidth is equal to the channel bandwidth multiplied by the number of channels in the hopset. The hopset shall be such that the near-term distribution of frequencies appears random, with sequential hops randomly distributed in both direction and magnitude of change in the hopset, whereas the long-term distribution appears evenly distributed.



### 9.3. Test Procedures

The EUT was setup according to ANSI C63.10: 2013 and tested according to FHSS test procedure of FCC KDB 558074 D01 v05r02 for compliance to FCC 47CFR 15.247 / RSS-247 issue 2 requirements

Use the following spectrum analyzer settings:

Span = approximately 2 to 3 times the 20 dB bandwidth, centered on a hopping channel

RBW  $\geq$  1% of the 20 dB bandwidth, VBW  $\geq$  RBW, Sweep = auto, Detector function = peak, Trace = max hold,

The EUT should be transmitting at its maximum data rate.

### 9.4. Test Specification

According to FCC Part 15 Subpart C Paragraph 15.247 / IC RSS-247 Issue 2.

**9.5. Test Result of 20dB Bandwidth**

Modulation	Channel	Frequency (MHz)	Measure Level (MHz)	Limit (MHz)
GFSK	00	2402	0.959	-
	39	2441	0.980	-
	78	2480	0.956	-
8-DPSK	00	2402	1.279	-
	39	2441	1.279	-
	78	2480	1.282	-

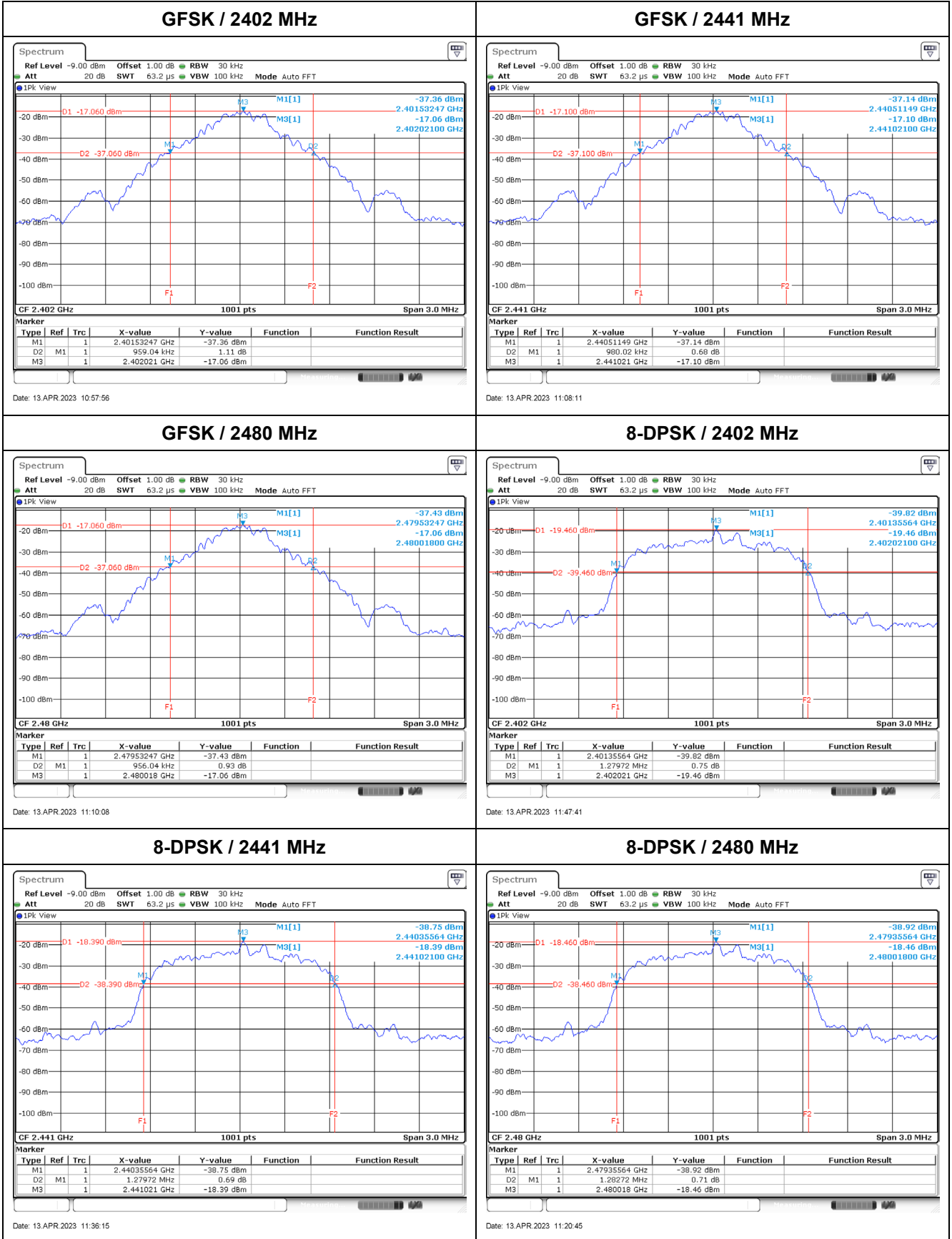

## 10. Dwell Time

### 10.1. Test Setup

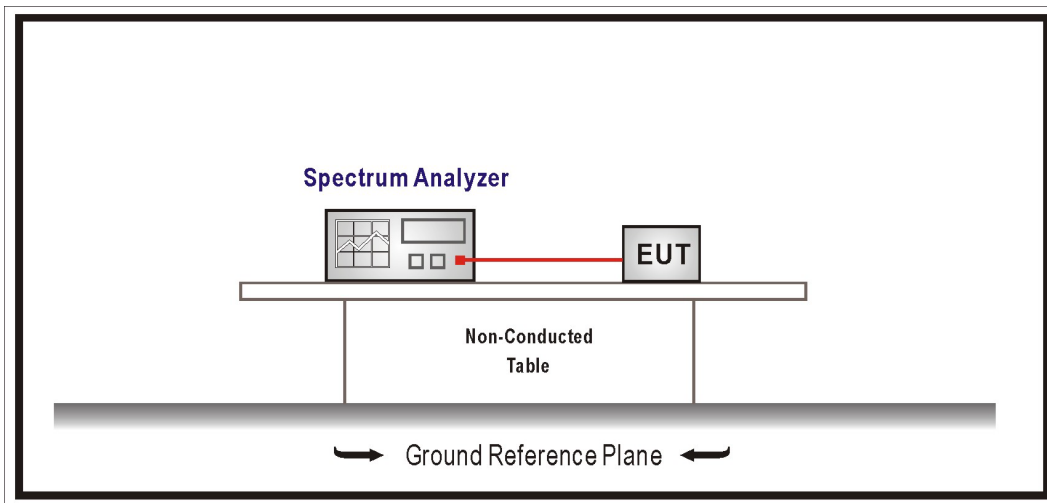

### 10.2. Test Limit

For frequency hopping systems operating in the 902-928 MHz band: if the 20 dB bandwidth of the hopping channel is less than 250 kHz, the system shall use at least 50 hopping frequencies and the average time of occupancy on any frequency shall not be greater than 0.4 seconds within a 20 second period; if the 20 dB bandwidth of the hopping channel is 250 kHz or greater, the system shall use at least 25 hopping frequencies and the average time of occupancy on any frequency shall not be greater than 0.4 seconds within a 10 second period.

For frequency hopping systems operating in the 2400-2483.5 MHz bands. The average time of occupancy on any channel shall not be greater than 0.4 seconds within a period of 0.4 seconds multiplied by the number of hopping channels employed.

For frequency hopping systems operating in the 5725-5850 MHz bands. The average time of occupancy on any frequency shall not be greater than 0.4 seconds within a 30 second period.

### **10.3. Test Procedures**

The EUT was setup according to ANSI C63.10: 2013 and tested according to FHSS test procedure of FCC KDB 558074 D01 v05r02 for compliance to FCC 47CFR 15.247 / RSS-247 issue 2 requirements

Span = zero span, centered on a hopping channel, RBW = 1 MHz, VBW  $\geq$  RBW,

Sweep = as necessary to capture the entire dwell time per hopping channel,

Detector function = peak, Trace = max hold.

### **10.4. Test Specification**

According to FCC Part 15 Subpart C Paragraph 15.247 / IC RSS-247 Issue 2.

### 10.5. Test Result of Dwell Time

Modulation	Occupancy Time of Frequency Hopping System
GFSK	A) 2402 MHz Test Time Period: $0.4 \times 79 = 31.60$ sec, Time slot length : 2.850 ms = 0.00285 sec Dwell Time : $0.00285 \times (266.67/79) \times 31.60 = 0.304$ sec
	B) 2441 MHz Test Time Period: $0.4 \times 79 = 31.60$ sec, Time slot length : 2.800 ms = 0.0028 sec Dwell Time : $0.0028 \times (266.67/79) \times 31.60 = 0.299$ sec
	C) 2480 MHz Test Time Period: $0.4 \times 79 = 31.60$ sec, Time slot length : 2.850 ms = 0.00285 sec Dwell Time : $0.00285 \times (266.67/79) \times 31.60 = 0.304$ sec
	A) 2402 MHz Test Time Period: $0.4 \times 79 = 31.60$ sec, Time slot length : 2.850 ms = 0.00285 sec Dwell Time : $0.00285 \times (266.67/79) \times 31.60 = 0.304$ sec
	B) 2441 MHz Test Time Period: $0.4 \times 79 = 31.60$ sec, Time slot length : 2.800 ms = 0.0028 sec Dwell Time : $0.0028 \times (266.67/79) \times 31.60 = 0.299$ sec
	C) 2480 MHz Test Time Period: $0.4 \times 79 = 31.60$ sec, Time slot length : 2.850 ms = 0.00285 sec Dwell Time : $0.00285 \times (266.67/79) \times 31.60 = 0.304$ sec
Test Result: The Average Occupancy Time of Each Highest, Middle and Lowest Channel Is Less Than 0.4 sec, And Corresponds to The Standard.	

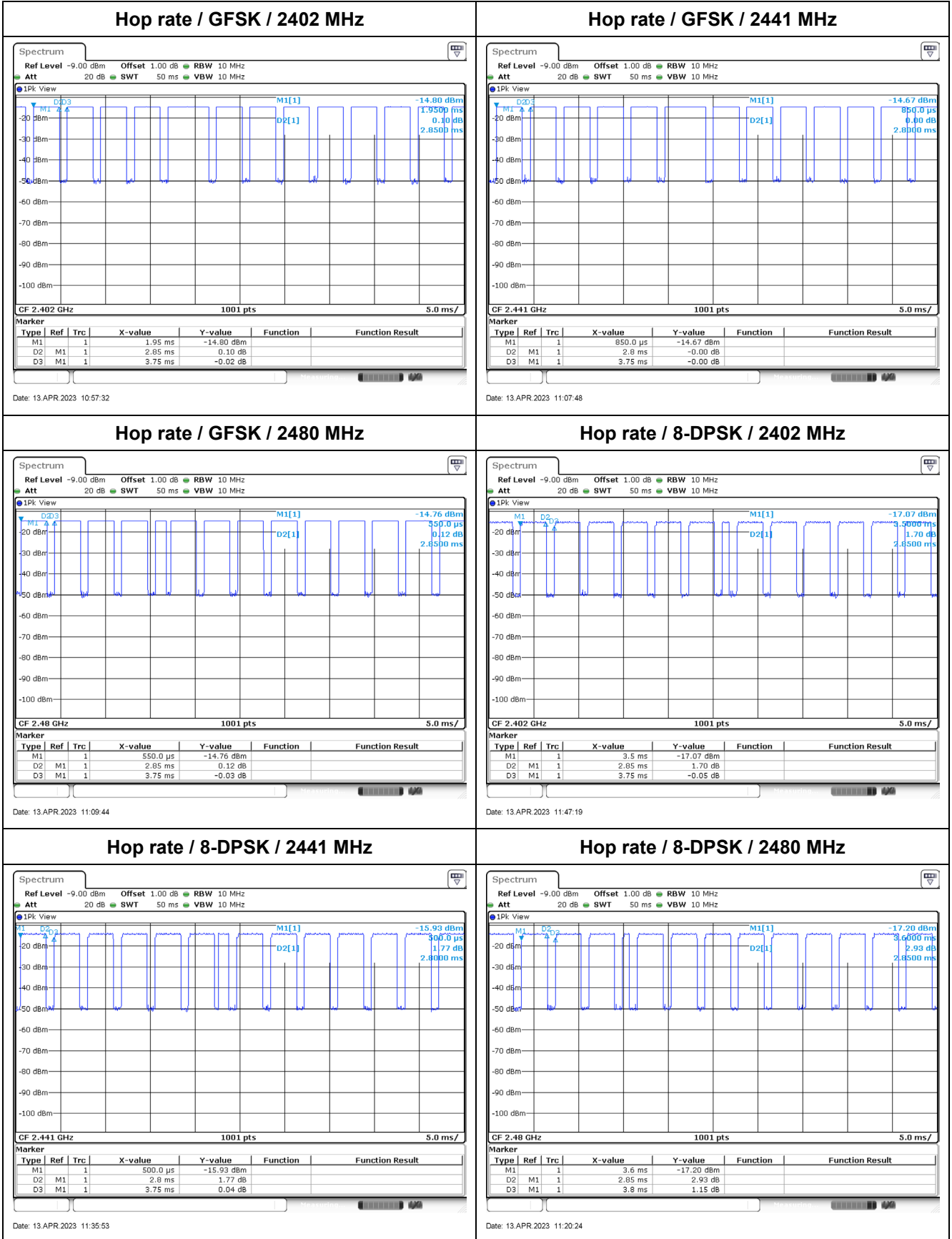

Note: Dwell time = time slot length \* hop rate / number of hopping channels \* period

## Appendix A

### ➤ Test Result of Radiated Emissions Co-location WWAN LTE Cat-M1 + Bluetooth BR+EDR function 30 MHz ~ 1 GHz:

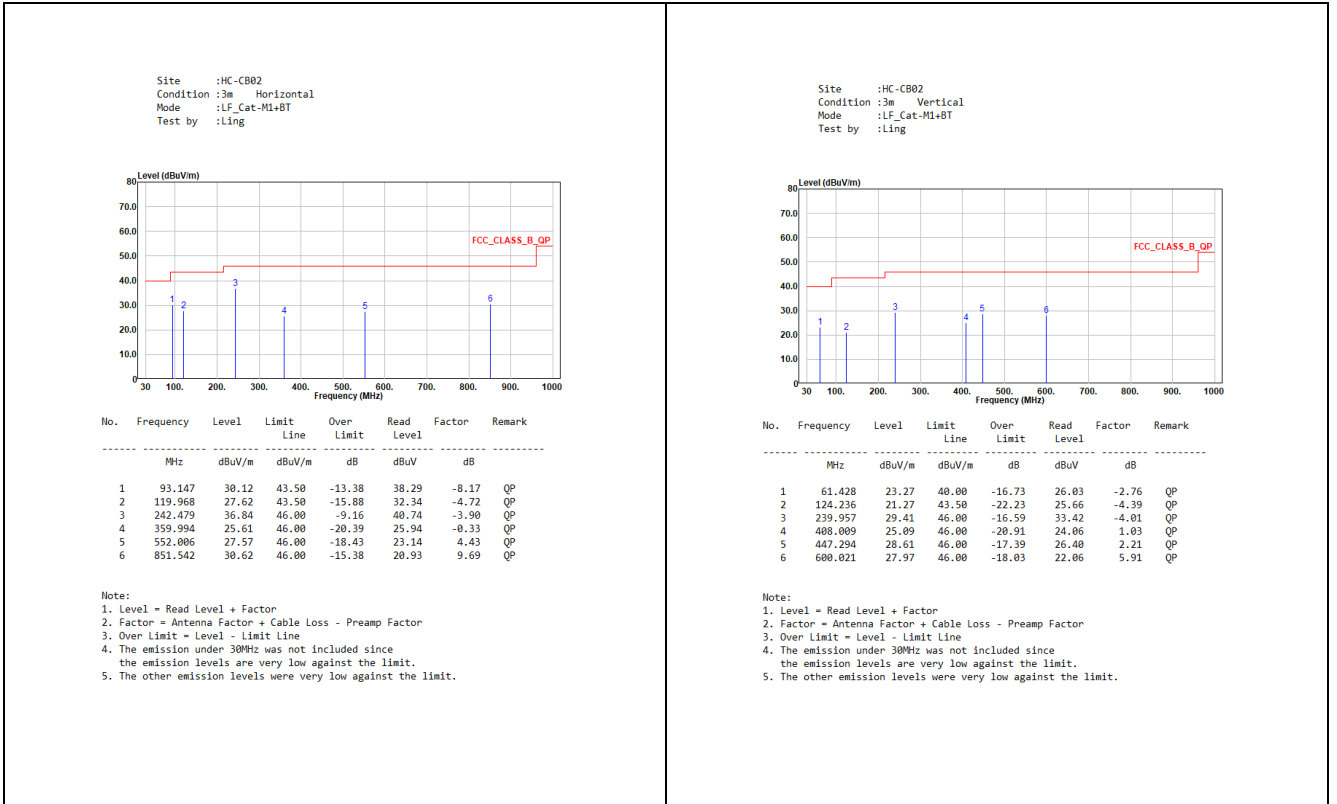

### Above 1 GHz:

