



BUREAU VERITAS

Test Report No.: W7L-P23070010RF11



FCC TEST REPORT

(Part 15, Subpart E)



Applicant:	Thundercomm Technology Co., Ltd.
Address:	No. 107, Middle Datagu Road, Xiantao Street, Yubei District, Chongqing, China, 401122

Manufacturer or Supplier:	Thundercomm Technology Co., Ltd.
Address:	No. 107, Middle Datagu Road, Xiantao Street, Yubei District, Chongqing, China, 401122
Product:	Edge AI Station
Brand Name:	Thundercomm
Model Name:	EB5S
FCC ID:	2AOHHEB5S
Date of tests:	Sep. 09, 2023 ~ Oct. 31, 2023

The tests have been carried out according to the requirements of the following standard:

FCC Part 15, Subpart E, Section 15.407

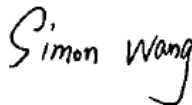
CONCLUSION: The submitted sample was found to COMPLY with the test requirement

Prepared by Simon Wang Engineer / Mobile Department	Approved by Luke Lu Manager / Mobile Department
 Date: Oct. 31, 2023	 Date: Oct. 31, 2023

This report is governed by, and incorporates by reference, the Conditions of Testing as posted at the date of issuance of this report at <http://www.bureauveritas.com/home/about-us/our-business/cps/about-us/terms-conditions/> and is intended for your exclusive use. Any copying or replication of this report to or for any other person or entity, or use of our name or trademark, is permitted only with our prior written permission. This report sets forth our findings solely with respect to the test samples identified herein. The results set forth in this report are not indicative or representative of the quality or characteristics of the lot from which a test sample was taken or any similar or identical product unless specifically and expressly noted. Our report includes all of the tests requested by you and the results thereof based upon the information that you provided to us. Measurement uncertainty is only provided upon request for accredited tests. Statements of conformity are based on simple acceptance criteria without taking measurement uncertainty into account, unless otherwise requested in writing. You have 60 days from date of issuance of this report to notify us of any material error or omission caused by our negligence or if you require measurement uncertainty; provided, however, that such notice shall be in writing and shall specifically address the issue you wish to raise. A failure to raise such issue within the prescribed time shall constitute your unqualified acceptance of the completeness of this report, the tests conducted and the correctness of the report contents.



TABLE OF CONTENTS

RELEASE CONTROL RECORD	4
1 SUMMARY OF TEST RESULTS	5
1.1 MEASUREMENT UNCERTAINTY	6
2 GENERAL INFORMATION.....	7
2.1 GENERAL DESCRIPTION OF EUT	7
2.2 DESCRIPTION OF TEST MODES	10
2.2.1 TEST MODE APPLICABILITY AND TESTED CHANNEL DETAIL.....	13
2.3 DUTY CYCLE OF TEST SIGNAL	17
2.4 DESCRIPTION OF SUPPORT UNITS	18
2.4.1 CONFIGURATION OF SYSTEM UNDER TEST	19
2.5 GENERAL DESCRIPTION OF APPLIED STANDARDS	20
3 TEST TYPES AND RESULTS.....	21
3.1 RADIATED EMISSION AND BANDEDGE MEASUREMENT.....	21
3.1.1 LIMITS OF RADIATED EMISSION AND BANDEDGE MEASUREMENT.....	21
3.1.2 LIMITS OF UNWANTED EMISSION.....	22
3.1.3 TEST INSTRUMENTS.....	23
3.1.4 TEST PROCEDURES	24
3.1.5 DEVIATION FROM TEST STANDARD	24
3.1.6 TEST SETUP	25
3.1.7 EUT OPERATING CONDITION	26
3.1.8 TEST RESULTS	27
3.2 CONDUCTED EMISSION MEASUREMENT	146
3.2.1 LIMITS OF CONDUCTED EMISSION MEASUREMENT	146
3.2.2 TEST INSTRUMENTS.....	146
3.2.3 TEST PROCEDURES	147
3.2.4 DEVIATION FROM TEST STANDARD	148
3.2.5 TEST SETUP	148
3.2.6 EUT OPERATING CONDITIONS	148
3.2.7 TEST RESULTS	149
3.3 AUTOMATICALLY DISCONTINUE TRANSMISSION	151
3.3.1 LIMIT OF AUTOMATICALLY DISCONTINUE TRANSMISSION	151
3.3.2 TEST INSTRUMENTS.....	151
3.3.3 TEST RESULT	151
4 PHOTOGRAPHS OF THE TEST CONFIGURATION	152



Test Report No.: W7L-P23070010RF11

5 MODIFICATIONS RECORDERS FOR ENGINEERING CHANGES TO THE EUT BY THE LAB153



BUREAU
VERITAS

Test Report No.: W7L-P23070010RF11

RELEASE CONTROL RECORD

ISSUE NO.	REASON FOR CHANGE	DATE ISSUED
W7L-P23070010RF11	Original release	Oct. 31, 2023



1 SUMMARY OF TEST RESULTS

The EUT has been tested according to the following specifications:

APPLIED STANDARD: FCC PART 15, SUBPART E		
STANDARD SECTION	TEST TYPE AND LIMIT	RESULT
15.407(b)(9)	AC Power Conducted Emission	Compliance
15.407(b) (1/2/3/4/5)	Radiated Emission & Band Edge Measurement	Compliance
15.407(a/1/2/3)	Maximum conducted output Power	See Note
15.407(a/1/2/3)	Peak Power Spectral Density	See Note
15.407(a)(2)(12)	26 dB Bandwidth	See Note
15.407(e)	6 dB Bandwidth	See Note
15.203	Antenna Requirement	Compliance

NOTE: Refer to Module report SZ22110114W04/ SZ22110114W04-1/ SZ22110114W04-2/
SZ22110114W04-3/ SZ22110114W04-4, FCC ID: 2A0HHTURBOXC865C. The verify results of
conducted power are similar or lower, So this report The power table are not updated.



1.1 MEASUREMENT UNCERTAINTY

Where relevant, the following measurement uncertainty levels have been estimated for tests performed on the EUT as specified in CISPR 16-4-2:

MEASUREMENT	UNCERTAINTY
AC Power Conducted emissions	±2.70dB
Radiated emissions (9KHz~30MHz)	±2.68dB
Radiated emissions (30MHz~1GHz)	±4.98dB
Radiated emissions (1GHz ~6GHz)	±4.70dB
Radiated emissions (6GHz ~18GHz)	±4.60dB
Radiated emissions (18GHz ~40GHz)	±4.12dB
Conducted emissions	±4.01dB
Occupied Channel Bandwidth	±43.58KHz
Conducted Output power	±2.06dB
Power Spectral Density	±0.85 dB

This uncertainty represents an expanded uncertainty expressed at approximately the 95% confidence level using a coverage factor of $k = 2$.



2 GENERAL INFORMATION

2.1 GENERAL DESCRIPTION OF EUT

PRODUCT	Edge AI Station
BRAND NAME	Thundercomm
MODEL NAME	EB5S
NOMINAL VOLTAGE	19Vdc(adapter)
MODULATION	OFDM, OFDMA
TRANSFER RATE	802.11a: 54.0/ 48.0/ 36.0/ 24.0/ 18.0/ 12.0/ 9.0/ 6.0Mbps 802.11n: up to 300.0Mbps 802.11ac: up to 866.6Mbps 802.11ax: up to 1201Mbps
OPERATING FREQUENCY	5180 ~ 5240MHz, 5260 ~ 5320MHz, 5500 ~ 5720MHz, 5745 ~ 5825MHz
NUMBER OF CHANNEL	5180 ~ 5240MHz: 4 for 802.11a, 802.11n/ac/ax (20MHz)/ 802.11ax(20MHz RU 26/52/106/242) 2 for 802.11n/ac/ax (40MHz RU 26/52/106/242/484) 1 for 802. 802.11ac/ax (80MHz RU 26/52/106/242/484/996) 5260 ~ 5320MHz: 4 for 802.11a, 802.11n/ac/ax (20MHz)/ 802.11ax(20M RU 26/52/106/242) 2 for 802.11n/ac/ax (40MHz 40MHz RU 26/52/106/242/484) 1 for 802.11ac/ax (80MHz RU 26/52/106/242/484/996) 5500 ~ 5720MHz: 12 for 802.11a, 802.11n/ac/ax (20MHz)/ 802.11ax(20M RU 26/52/106/242) 6 for 802.11n/ac/ax (40MHz RU 26/52/106/242/484) 3 for 802.11ac/ax (80MHz RU 26/52/106/242/484/996) 5745 ~ 5825MHz: 5 for 802.11a, 802.11n/ac/ax (20MHz)/ 802.11ax(20M RU 26/52/106/242) 2 for 802.11n/ac/ax (40MHz RU 26/52/106/242/484) 1 for 802.11ac/ax (80MHz RU 26/52/106/242/484/996)
AVERAGE POWER	80.91 mW for 5180 ~ 5240MHz 85.90 mW for 5260 ~ 5320MHz 82.04 mW for 5500 ~ 5720MHz 99.08 mW for 5745 ~ 5825MHz



ANTENNA TYPE	Fixed External Antenna
ANTENNA GAIN	ANT 0/1: -4.13dBi for 5180 ~ 5240MHz -3.98dBi for 5260 ~ 5320MHz -0.68dBi for 5500 ~ 5720MHz -1.42dBi for 5745 ~ 5825MHz
HW VERSION	Turbox EB5S-IO-BOARD V03
SW VERSION	R.5S.LA.2.20231030
I/O PORTS	Refer to user's manual
CABLE SUPPLIED	N/A

NOTE:

- For a more detailed features description, please refer to the manufacturer's specifications or the user's manual.
- The EUT incorporates a SISO function for A mode, and a MIMO function for N20/N40/AC20/AC40/AC80/AX20/AX40/AX80 mode. Physically, the EUT provides two transmitters and two receivers.

MODULATION MODE	TX FUNCTION
802.11a	2TX/2RX
802.11n/802.11ac/ax (20MHz)	2TX/2RX
802.11n/802.11ac/ax (40MHz)	2TX/2RX
802.11ac/ax (80MHz)	2TX/2RX
802.11ax (20MHz RU 26/52/106/242)	2TX/2RX
802.11ax (40MHz RU 26/52/106/242/484)	2TX/2RX
802.11ax (80MHz RU 26/52/106/242/484/996)	2TX/2RX

- For the test results, the EUT had been tested with all conditions. But only the worst case was shown in test report.
- According to KDB 662911 D01, the directional gain = $G_{ANT} + 10\log(N_{ANT})$ dBi, where G_{ANT} is the maximum antenna gain in dBi, N_{ANT} is the number of outputs. The directional gain of each band can be calculated as below:

Frequency Range	Ant 0 Gain(dBi)	Ant 1 Gain(dBi)	Directional Gain(dBi)
5180 ~ 5240MHz	-4.13	-4.13	-1.12
5260 ~ 5320MHz	-3.98	-3.98	-0.97
5500 ~ 5720MHz	-0.68	-0.68	2.33
5745 ~ 5825MHz	-1.42	-1.42	1.59

The directional gain of each band less than 6dBi, so the power limit needn't to be reduced.



Test Report No.: W7L-P23070010RF11

List of Accessory:

ACCESSORIES	BRAND	MANUFACTURER	MODEL	SPECIFICATION
AC Adapter	Huntkey	Shenzhen Huntkey Electric Co. Ltd.	HKA09019047-6U	I/P: 100-240Vac, 1.5A, O/P: 19Vdc, 3.15A



2.2 DESCRIPTION OF TEST MODES

FOR 5180 ~ 5240MHz

4 channels are provided for 802.11a, 802.11n, 802.11ac/ax (20MHz)/ 802.11ax (20MHz RU 26/52/106/242):

CHANNEL	FREQUENCY	CHANNEL	FREQUENCY
36	5180 MHz	44	5220 MHz
40	5200 MHz	48	5240 MHz

2 channels are provided for 802.11n, 802.11ac/ax (40MHz RU 26/52/106/242/484):

CHANNEL	FREQUENCY	CHANNEL	FREQUENCY
38	5190 MHz	46	5230 MHz

1 channel is provided for 802.11ac/ax (80MHz RU 26/52/106/242/484/996):

CHANNEL	FREQUENCY	CHANNEL	FREQUENCY
42	5210 MHz		

FOR 5260 ~ 5320MHz

4 channels are provided for 802.11a, 802.11n, 802.11ac/ax (20MHz)/ 802.11ax (20MHz RU 26/52/106/242):

CHANNEL	FREQUENCY	CHANNEL	FREQUENCY
52	5260 MHz	60	5300 MHz
56	5280 MHz	64	5320 MHz

2 channels are provided for 802.11n, 802.11ac/ax (40MHz RU 26/52/106/242/484):

CHANNEL	FREQUENCY	CHANNEL	FREQUENCY
54	5270 MHz	62	5310 MHz

1 channel is provided for 802.11ac/ax (80MHz RU 26/52/106/242/484/996)

CHANNEL	FREQUENCY	CHANNEL	FREQUENCY
58	5290 MHz		



FOR 5500 ~ 5720MHz

12 channels are provided for 802.11a, 802.11n, 802.11ac/ax (20MHz)/ 802.11ax (20MHz RU 26/52/106/242):

CHANNEL	FREQUENCY	CHANNEL	FREQUENCY
100	5500 MHz	124	5620MHz
104	5520 MHz	128	5640MHz
108	5540 MHz	132	5660 MHz
112	5560 MHz	136	5680 MHz
116	5580 MHz	140	5700 MHz
120	5600 MHz	144	5720 MHz

6 channels are provided for 802.11n, 802.11ac/ax (40MHz RU 26/52/106/242/484)

CHANNEL	FREQUENCY	CHANNEL	FREQUENCY
102	5510 MHz	126	5630MHz
110	5550 MHz	134	5670 MHz
118	5590 MHz	142	5710 MHz

3 channel is provided for 802.11ac/ax (80MHz RU 26/52/106/242/484/996)

CHANNEL	FREQUENCY	CHANNEL	FREQUENCY
106	5530 MHz	138	5690 MHz
122	5610 MHz		



FOR 5745 ~ 5825MHz

5 channels are provided for 802.11a, 802.11n, 802.11ac/ax (20MHz)/ 802.11ax (20MHz RU 26/52/106/242):

CHANNEL	FREQUENCY	CHANNEL	FREQUENCY
149	5745 MHz	161	5805 MHz
153	5765 MHz	165	5825 MHz
157	5785 MHz		

2 channels are provided for 802.11n, 802.11ac/ax (40MHz RU 26/52/106/242/484):

CHANNEL	FREQUENCY	CHANNEL	FREQUENCY
142	5710 MHz	159	5795 MHz
151	5755 MHz		

1 channel is provided for 802.11ac/ax (80MHz RU 26/52/106/242/484/996)

CHANNEL	FREQUENCY
155	5775 MHz



2.2.1 TEST MODE APPLICABILITY AND TESTED CHANNEL DETAIL

EUT CONFIGURE MODE	APPLICABLE TO				DESCRIPTION
	RE≥1G	RE<1G	PLC	APCM	
A	√	√	√	-	Powered by Adapter with wifi(5G) link
B	-	-	-	-	Powered by Battery with wifi(5G) link
C	-	-	-	-	Powered by USB with wifi(5G) link

Where **RE≥1G**: Radiated Emission above 1GHz **RE<1G**: Radiated Emission below 1GHz
PLC: Power Line Conducted Emission **APCM**: Antenna Port Conducted Measurement

NOTE:
The EUT had been pre-tested on the positioned of each 3 axis. The worst case was found when positioned on **X-plane**.
NOTE: “-” means no effect

RADIATED EMISSION TEST (BELOW 1GHz):

- Pre-Scan has been conducted to determine the worst-case mode from all possible combinations between available modulations, data rates and antenna ports (if EUT with antenna diversity architecture).
- The following channel(s) was (were) selected for the final test as listed below.

EUT CONFIGURE MODE	MODE	FREQ. BAND (MHz)	AVAILABLE CHANNEL	TESTED CHANNEL	MODULATION	DATA RATE (Mbps)
A	802.11a	5500-5720	100 to 144	144	OFDM	6.0



RADIATED EMISSION TEST (ABOVE 1GHz):

- Pre-Scan has been conducted to determine the worst-case mode from all possible combinations between available modulations, data rates and antenna ports (if EUT with antenna diversity architecture).
- The following channel(s) was (were) selected for the final test as listed below.

EUT CONFIGURE MODE	MODE	FREQ. BAND (MHz)	AVAILABLE CHANNEL	TESTED CHANNEL	MODULATION	DATA RATE (Mbps)
A	802.11a	5180-5240	36 to 48	36, 40, 48	OFDM	6.0
A	802.11an/ac/ax (20MHz)/ 802.11ax (20MHz RU 26)		36 to 48	36, 40, 48	OFDM, OFDMA	MCS0
A	802.11an/ac/ax (40MHz)		38 to 46	38, 46	OFDM, OFDMA	MCS0
A	802.11ac/ax (80MHz)		42	42	OFDM, OFDMA	MCS0
A	802.11a	5260-5320	52 to 64	52, 60, 64	OFDM	6.0
A	802.11an/ac/ax (20MHz)/ 802.11ax (20MHz RU 26)		52 to 64	52, 60, 64	OFDM, OFDMA	MCS0
A	802.11an/ac/ax (40MHz)		54 to 62	54, 62	OFDM, OFDMA	MCS0
A	802.11ac/ax (80MHz)		58	58	OFDM, OFDMA	MCS0
A	802.11a	5500-5720	100 to 144	100, 116, 140, 144	OFDM	6.0
A	802.11an/ac/ax (20MHz)/ 802.11ax (20MHz RU 26)		100 to 144	100, 116, 140, 144	OFDM, OFDMA	MCS0
A	802.11an/ac/ax (40MHz)		102 to 142	102, 110, 134, 142	OFDM, OFDMA	MCS0
A	802.11ac/ax (80MHz)		106 to 138	106, 138	OFDM, OFDMA	MCS0
A	802.11a	5745-5825	144 to 165	144,149, 157,165	OFDM	6.0
A	802.11an/ac/ax (20MHz)/ 802.11ax (20MHz RU 26)		144 to 165	144,149, 157,165	OFDM, OFDMA	MCS0
A	802.11an/ac/ax (40MHz)		142 to 159	142,151, 159	OFDM, OFDMA	MCS0
A	802.11ac/ax (80MHz)		138 to 155	138,155	OFDM, OFDMA	MCS0



POWER LINE CONDUCTED EMISSION TEST:

- Pre-Scan has been conducted to determine the worst-case mode from all possible combinations between available modulations, data rates and antenna ports (if EUT with antenna diversity architecture).
- The following channel(s) was (were) selected for the final test as listed below.

EUT CONFIGURE MODE	MODE	FREQ. BAND (MHz)	AVAILABLE CHANNEL	TESTED CHANNEL	MODULATION	DATA RATE (Mbps)
A	802.11a	5500-5720	100 to 144	144	OFDM	6.0



Test Report No.: W7L-P23070010RF11

TEST CONDITION:

APPLICABLE TO	ENVIRONMENTAL CONDITIONS	INPUT POWER	TESTED BY
RE<1G	23deg. C, 70%RH	DC 19V By Adapter	Jace Hu
RE≥1G	23deg. C, 70%RH	DC 19V By Adapter	Jace Hu
PLC	25deg. C, 52%RH	DC 19V By Adapter	James Fu



Test Report No.: W7L-P23070010RF11

2.3 DUTY CYCLE OF TEST SIGNAL

Refer to Module report SZ22110114W04/ SZ22110114W04-1/ SZ22110114W04-2/ SZ22110114W04-3/
SZ22110114W04-4, FCC ID: 2AOHHTURBOXC865C.



2.4 DESCRIPTION OF SUPPORT UNITS

The EUT has been tested as an independent unit together with other necessary accessories or support units. The following support units or accessories were used to form a representative test configuration during the tests.

NO.	PRODUCT	BRAND	MODEL NO.	SERIAL NO.	FCC ID
1	Desktop	Lenovo	M73 SFF	PC04GRQV	N/A
2	Desktop	Lenovo	M73 SFF	PC06CS27	N/A
3	Laptop	Lenovo	ThinkpadL440	R90FTFKN	N/A

NO.	SIGNAL CABLE DESCRIPTION OF THE ABOVE SUPPORT UNITS
1	AC Line: Unshielded, Detachable 1.5m
2	AC Line: Unshielded, Detachable 1.5m
3	AC Line: Unshielded, Detachable 1.5m
4	USB Line: Unshielded, Detachable 1.5m



2.4.1 CONFIGURATION OF SYSTEM UNDER TEST

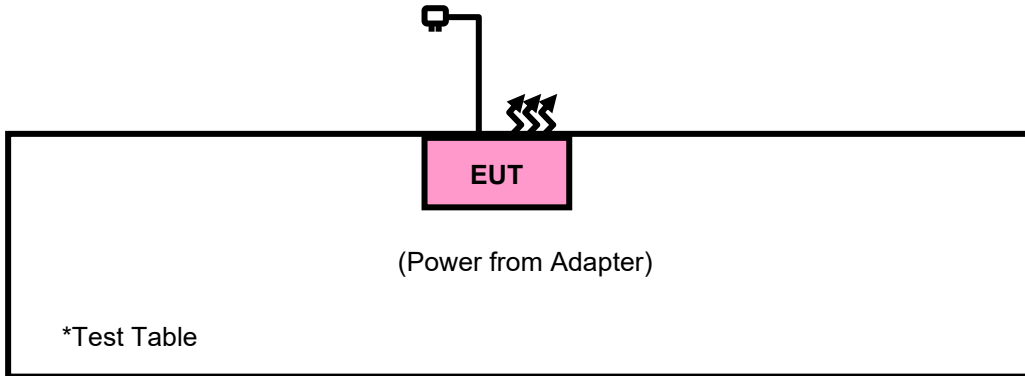



2.5 GENERAL DESCRIPTION OF APPLIED STANDARDS

The EUT is a RF Product. According to the specifications of the manufacturer, it must comply with the requirements of the following standards:

FCC Part 15, Subpart E (15.407)

KDB 789033 D02 General U-NII Test Procedures New Rules v02r01

ANSI C63.10-2013

All test items have been performed and recorded as per the above standards.

NOTE: The EUT is also considered as a kind of computer peripheral, because the connection to computer is necessary for typical use. It has been verified to comply with the requirements of FCC Part 15, Subpart B, Class B (Certification). The test report has been issued separately.



3 TEST TYPES AND RESULTS

3.1 RADIATED EMISSION AND BANDEDGE MEASUREMENT

3.1.1 LIMITS OF RADIATED EMISSION AND BANDEDGE MEASUREMENT

Radiated emissions which fall in the restricted bands must comply with the radiated emission limits specified as below table:

FREQUENCIES (MHz)	FIELD STRENGTH (microvolts/meter)	MEASUREMENT DISTANCE (meters)
0.009 ~ 0.490	2400/F(kHz)	300
0.490 ~ 1.705	24000/F(kHz)	30
1.705 ~ 30.0	30	30
30 ~ 88	100	3
88 ~ 216	150	3
216 ~ 960	200	3
Above 960	500	3

NOTE:

1. The lower limit shall apply at the transition frequencies.
2. Emission level (dBuV/m) = 20 log Emission level (uV/m).
3. For frequencies above 1000MHz, the field strength limits are based on average detector, however, the peak field strength of any emission shall not exceed the maximum permitted average limits, specified above by more than 20dB under any condition of modulation.

3.1.2 LIMITS OF UNWANTED EMISSION

RESTRICTED BANDS	APPLICABLE TO	LIMIT	
	789033 D02 General UNII Test Procedures New Rules v02r01	FIELD STRENGTH AT 3m (dBμV/m)	
		PK: 74	AV: 54
OUT OF THE RESTRICTED BANDS	APPLICABLE TO	EIRP LIMIT (dBm/MHz)	EQUIVALENT FIELD STRENGTH AT 3m (dBμV/m)
	15.407(b)(1)	PK: -27	PK: 68.2
	15.407(b)(2)		
	15.407(b)(3)		
	15.407(b)(4)	See note 2 (FCC 16-24)	

NOTE: 1. The following formula is used to convert the equipment isotropic radiated power (eirp) to field strength:

$$E = \frac{1000000 \sqrt{30P}}{3} \text{ } \mu\text{V/m, where P is the eirp (Watts).}$$

2. All emissions shall be limited to a level of -27 dBm/MHz at 75 MHz or more above or below the band edge increasing linearly to 10 dBm/MHz at 25 MHz above or below the band edge, and from 25 MHz above or below the band edge increasing linearly to a level of 15.6 dBm/MHz at 5 MHz above or below the band edge, and from 5 MHz above or below the band edge increasing linearly to a level of 27 dBm/MHz at the band edge.

**3.1.3 TEST INSTRUMENTS**

Equipment	Manufacturer	Model No.	Serial No.	Last Cal.	Next Cal.
Pre-Amplifier	R&S	SCU18F1	100815	Aug.30,22	Aug.29,24
Pre-Amplifier	R&S	SCU08F1	101028	Sep.16,22	Sep.15,24
Signal Generator	R&S	SMB100A	182185	Feb.16,22	Feb.15,24
3m Fully-anechoic Chamber	TDK	9m*6m*6m	HRSW-SZ-EMC-01Chamber	Nov.25,22	Nov.24,25
3m Semi-anechoic Chamber	TDK	9m*6m*6m	HRSW-SZ-EMC-02Chamber	Nov.25,22	Nov.24,25
EMI TEST Receiver	R&S	ESW44	101973	Feb.25,22	Feb.24,24
Bilog Antenna	SCHWARZBECK	VULB 9163	1264	Feb.28,22	Feb.27,24
Horn Antenna	ETS-LINDGREN	3117	227836	Aug.22,22	Aug.21,24
Horn Antenna (18GHz-40GHz)	Steatite Q-par Antennas	QMS 00880	23486	Feb.23,22	Feb.22,24
Horn Antenna	Steatite Q-par Antennas	QMS 00208	23485	Aug.22,22	Aug.21,24
Loop Antenna	SCHWARZ	HFH2-Z2/Z2E	100976	Feb.23,22	Feb.22,24
WIDEBANDRADIO COMMUNICATION TESTER	R&S	CMW500	169399	Jun.27,22	Jun.26,24
Test Software	ELEKTRA	ELEKTRA4.32	N/A	N/A	N/A
Open Switch and Control Unit	R&S	OSP220	101964	N/A	N/A
DC Source	HYELEC	HY3010B	551016	Aug.31,22	Aug.30,24
Hygrothermograph	DELI	20210528	SZ014	Sep.06,22	Sep.05,24
6DB attenuator	Tonscend Technology Co., Ltd	N/A	23062787	N/A	N/A
PC	LENOVO	E14	HRSW0024	N/A	N/A
TMC-AMI18843A(CABLE)	R&S	HF290-NMNM-7.00M	N/A	N/A	N/A
TMC-AMI18843A(CABLE)	R&S	HF290-NMNM-4.00M	N/A	N/A	N/A
CABLE	R&S	W13.02	N/A	Apr.28,23	Oct.27,23
CABLE	R&S	W13.02	N/A	Oct.27,23	Apr.26,24
CABLE	R&S	W12.14	N/A	Apr.28,23	Oct.27,23
CABLE	R&S	W12.14	N/A	Oct.27,23	Apr.26,24

- NOTE:**
1. The calibration interval of the above test instruments is 6 months or 24months or 36 months and the calibrations are traceable to CEPREI/CHINA, GRGT/CHINA and NIM/CHINA.
 2. The test was performed in 3m Chamber.
 3. The FCC Site Registration No. is 525120; The Designation No. is CN1171.

3.1.4 TEST PROCEDURES

- a. The EUT was placed on the top of a rotating table 0.8 meters (for below 1GHz) / 1.5 meters (for above 1GHz) above the ground at 3 meter chamber room for test. The table was rotated 360 degrees to determine the position of the highest radiation.
- b. The EUT was set 3 meters away from the interference-receiving antenna, which was mounted on the top of a variable-height antenna tower.
- c. The antenna is a broadband antenna, and its height is varied from one meter to four meters above the ground to determine the maximum value of the field strength. Both horizontal and vertical polarizations of the antenna are set to make the measurement.
- d. For each suspected emission, the EUT was arranged to its worst case and then the antenna was tuned to heights from 1 meter to 4 meters and the rotatable table was turned from 0 degrees to 360 degrees to find the maximum reading.
- e. The test-receiver system was set to Peak Detect Function and Specified Bandwidth with Maximum Hold Mode.
- f. If the emission level of the EUT in peak mode was 10dB lower than the limit specified, then testing could be stopped and the peak values of the EUT would be reported. Otherwise, the emissions that did not have 10dB margin would be re-tested one by one using peak, quasi-peak or average method as specified and then reported in a data sheet.

NOTE:

1. The resolution bandwidth and video bandwidth of test receiver/spectrum analyzer is 120kHz for Peak detection (PK) and Quasi-peak detection (QP) at frequency below 1GHz.
2. The resolution bandwidth of test receiver/spectrum analyzer is 1MHz and video bandwidth is 3MHz for Peak detection at frequency above 1GHz.
3. The resolution bandwidth of test receiver/spectrum analyzer is 1MHz and the video bandwidth is 3MHz for RMS Average (Duty cycle < 98%) for Average detection (AV) at frequency above 1GHz, then the measurement results was added to a correction factor ($10 \log(1/\text{duty cycle})$).
4. The resolution bandwidth of test receiver/spectrum analyzer is 1MHz and the video bandwidth is 10Hz (Duty cycle \geq 98%) for Average detection (AV) at frequency above 1GHz.
5. All modes of operation were investigated and the worst-case emissions are reported.

3.1.5 DEVIATION FROM TEST STANDARD

No deviation.



3.1.6 TEST SETUP

<Frequency Range 9KHz~30MHz >

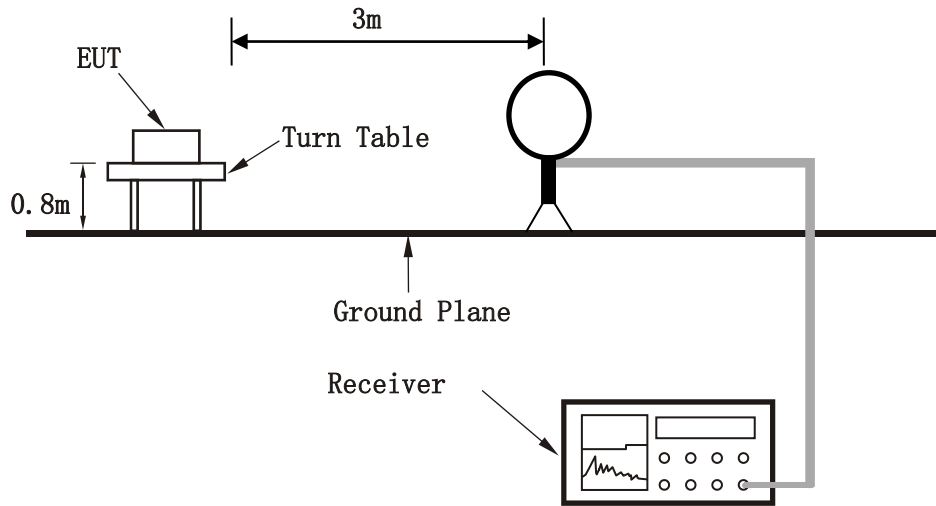

< Frequency Range 30MHz~1GHz >

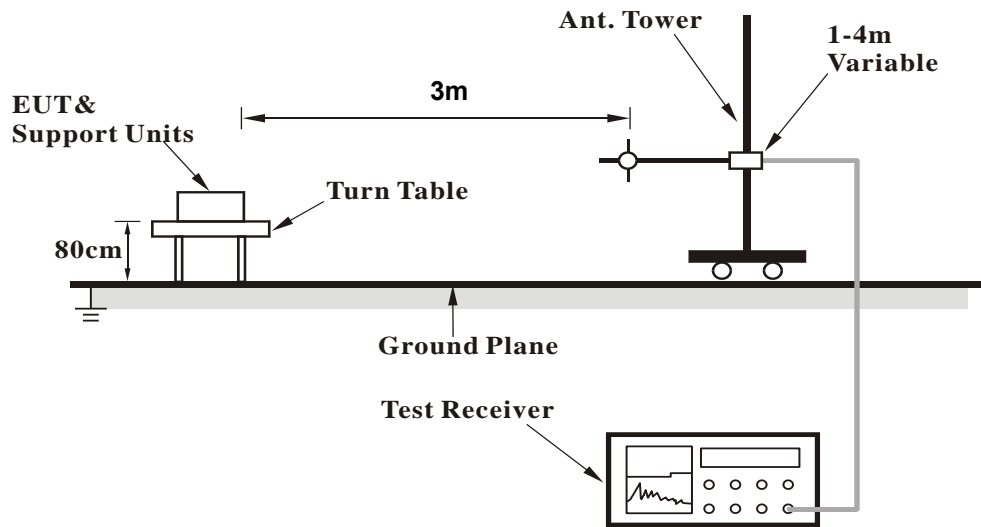



<Frequency Range above 1GHz>

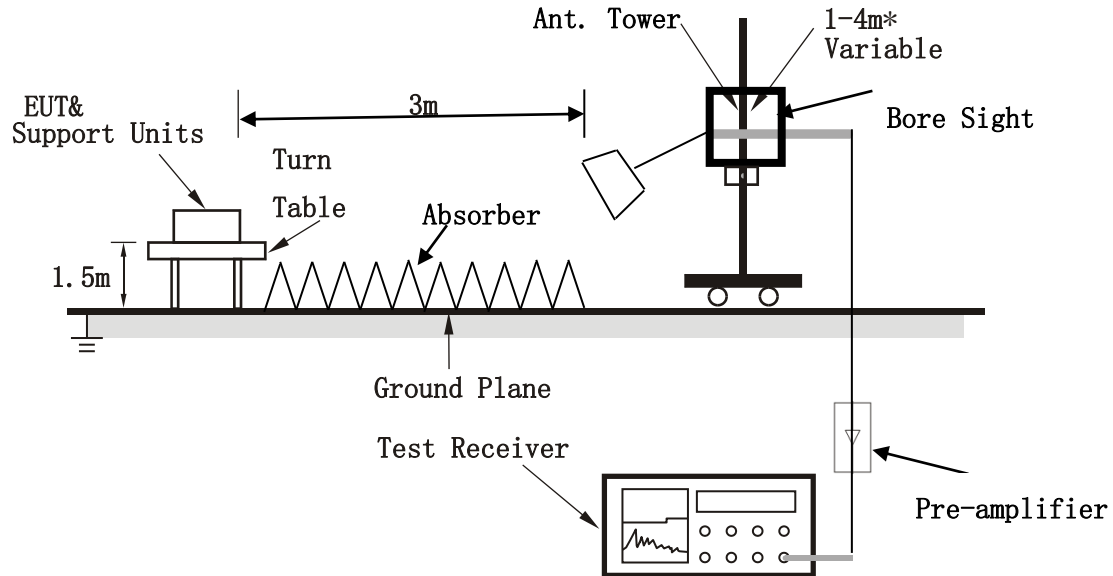

Note: Above 1G is a directional antenna

Depends on the EUT height and the antenna 3dB beamwidth both, refer to section 7.3 of CISPR 16-2-3.

For the actual test configuration, please refer to the attached file (Test Setup Photo).

3.1.7 EUT OPERATING CONDITION

- a. Set the EUT under full load condition and placed them on a testing table.
- b. Set the transmitter part of EUT under transmission condition continuously at specific channel frequency.
- c. The necessary accessories enable the EUT in full functions.



3.1.8 TEST RESULTS

NOTE : The 9K~30MHz amplitude of spurious emissions attenuated more than 20 dB below the permissible value is not required in the report.

30 MHz – 1GHz data:

Band 3

802.11a:

CHANNEL	TX Channel 144	DETECTOR FUNCTION	Quasi-Peak (QP)
FREQUENCY RANGE	30MHz ~ 1GHz		

ANTENNA POLARITY & TEST DISTANCE: HORIZONTAL AT 3 M

Rg	Frequency [MHz]	PK+ Level [dBμV/m]	PK+: QPK Limit [dBμV/m]	PK+ Margin [dB]	Correction [dB]	Polarization	Azimuth [deg]	Antenna Height [m]
1	41.689	26.81	40.00	13.19	-9.34	H	1.3	2
1	95.912	25.88	43.50	17.62	-10.98	H	227.9	2
1	146.643	25.41	43.50	18.09	-13.69	H	95.2	2
1	234.573	25.85	46.00	20.15	-9.27	H	95.2	2
1	360.964	26.68	46.00	19.32	-5.99	H	358.6	1
1	797.367	28.21	46.00	17.79	1.91	H	5.8	1

REMARKS:

1. Emission level (dBuV/m) = Read level (dBuV) + Correction Factor (dB/m).
2. Correction Factor (dB/m) = Antenna Factor (dB/m) + Cable Factor (dB).
3. The other emission levels were very low against the limit.
4. Margin value = Limit value – Emission Level.

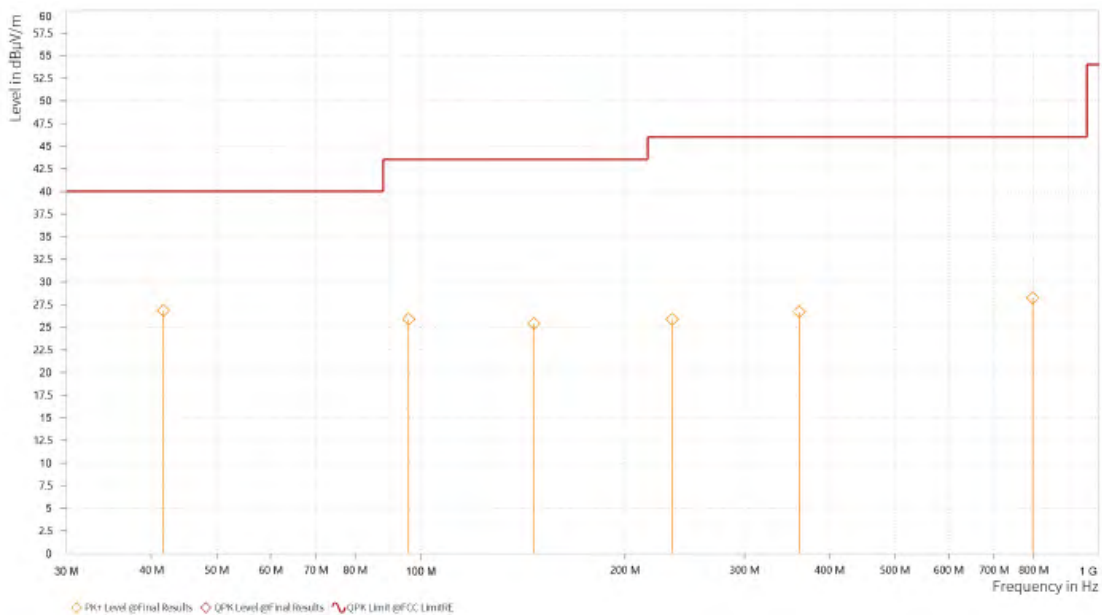



CHANNEL	Channel 144	DETECTOR FUNCTION	Quasi-Peak (QP)
FREQUENCY RANGE	30MHz ~ 1GHz		

ANTENNA POLARITY & TEST DISTANCE: VERTICAL AT 3 M

Rg	Frequency [MHz]	PK+ Level [dBµV/m]	PK+: QPK Limit [dBµV/m]	PK+ Margin [dB]	Correction [dB]	Polarization	Azimuth [deg]	Antenna Height [m]
1	44.114	27.41	40.00	12.59	-9.02	V	94	2
1	96.688	23.03	43.50	20.47	-10.84	V	94	2
1	167.207	20.04	43.50	23.46	-12.73	V	358.6	1
1	235.737	24.58	46.00	21.42	-9.24	V	129.8	1
1	471.302	20.83	46.00	25.17	-3.95	V	229	2
1	884.425	27.74	46.00	18.26	3.40	V	229	2

REMARKS:

1. Emission level (dBuV/m) = Read level (dBuV) + Correction Factor (dB/m).
2. Correction Factor (dB/m) = Antenna Factor (dB/m) + Cable Factor (dB).
3. The other emission levels were very low against the limit.
4. Margin value = Limit value – Emission Level.

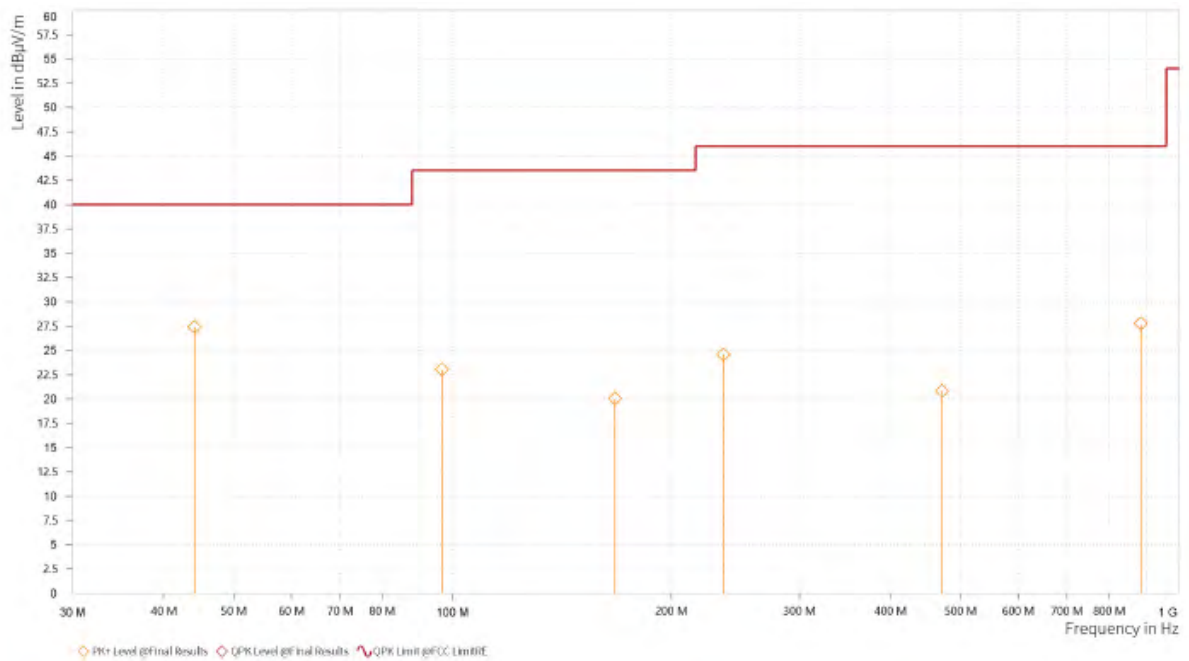



ABOVE 1GHZ WORST-CASE DATA:

Note: For higher frequency, the emission is too low to be detected.

Band 1

802.11a

CHANNEL	TX Channel 36	DETECTOR FUNCTION	Peak (PK)
FREQUENCY RANGE	1GHz ~ 40GHz		Average (AV)

ANTENNA POLARITY & TEST DISTANCE: HORIZONTAL AT 3 M

Rg	Frequency [MHz]	AVG Level [dBµV/m]	AVG Limit [dBµV/m]	AVG Margin [dB]	Correction [dB]	Polarization	Azimuth [deg]	Antenna Height [m]
1	5,149.500	35.96	54.00	18.04	15.02	H	138.2	1
1	5,150.000	35.88	54.00	18.12	15.02	H	138.2	1
1	5,176.500	87.15			15.13	H	138.2	1

Rg	Frequency [MHz]	PK+ Level [dBµV/m]	PK+ Limit [dBµV/m]	PK+ Margin [dB]	Correction [dB]	Polarization	Azimuth [deg]	Antenna Height [m]
1	5,127.000	50.76	74.00	23.24	15.00	H	1	1
1	5,150.000	49.35	74.00	24.65	15.02	H	36.6	2
1	5,177.000	99.20			15.13	H	137	1

ANTENNA POLARITY & TEST DISTANCE: VERTICAL AT 3 M

Rg	Frequency [MHz]	AVG Level [dBµV/m]	AVG Limit [dBµV/m]	AVG Margin [dB]	Correction [dB]	Polarization	Azimuth [deg]	Antenna Height [m]
1	5,148.500	35.86	54.00	18.14	15.02	V	221.8	2
1	5,150.000	35.98	54.00	18.02	15.02	V	221.8	2
1	5,179.000	85.22			15.14	V	5.1	1

Rg	Frequency [MHz]	PK+ Level [dBµV/m]	PK+ Limit [dBµV/m]	PK+ Margin [dB]	Correction [dB]	Polarization	Azimuth [deg]	Antenna Height [m]
1	5,124.500	50.90	74.00	23.10	15.00	V	359	2
1	5,150.000	49.89	74.00	24.11	15.02	V	0.9	2
1	5,179.000	97.07			15.14	V	5.8	1

REMARKS:

- Emission Level = Read Level+ Antenna Factor + Cable Loss- Preamp Factor
Margin value = Limit value – Emission Level.
- 5180MHz: Fundamental frequency.



CHANNEL	TX Channel 40	DETECTOR FUNCTION	Peak (PK)
FREQUENCY RANGE	1GHz ~ 40GHz		Average (AV)

ANTENNA POLARITY & TEST DISTANCE: HORIZONTAL AT 3 M

Rg	Frequency [MHz]	AVG Level [dBμV/m]	AVG Limit [dBμV/m]	AVG Margin [dB]	Correction [dB]	Polarization	Azimuth [deg]	Antenna Height [m]
2	5,147.500	35.85	54.00	18.15	15.02	H	114.2	1
2	5,150.000	35.73	54.00	18.27	15.02	H	114.2	1
2	5,203.000	88.40			15.27	H	114.2	1

Rg	Frequency [MHz]	PK+ Level [dBμV/m]	PK+ Limit [dBμV/m]	PK+ Margin [dB]	Correction [dB]	Polarization	Azimuth [deg]	Antenna Height [m]
2	5,137.500	50.54	74.00	23.46	15.01	H	175.3	2
2	5,150.000	49.47	74.00	24.53	15.02	H	128.6	2
2	5,205.500	98.70			15.27	H	221.8	2

ANTENNA POLARITY & TEST DISTANCE: VERTICAL AT 3 M

Rg	Frequency [MHz]	AVG Level [dBμV/m]	AVG Limit [dBμV/m]	AVG Margin [dB]	Correction [dB]	Polarization	Azimuth [deg]	Antenna Height [m]
2	5,148.000	35.80	54.00	18.20	15.02	V	175.4	1
2	5,150.000	35.77	54.00	18.23	15.02	V	175.4	1
2	5,195.000	82.20			15.24	V	243.4	2

Rg	Frequency [MHz]	PK+ Level [dBμV/m]	PK+ Limit [dBμV/m]	PK+ Margin [dB]	Correction [dB]	Polarization	Azimuth [deg]	Antenna Height [m]
2	5,126.000	51.52	74.00	22.48	15.00	V	359	1
2	5,150.000	50.54	74.00	23.46	15.02	V	176.5	2
2	5,196.000	95.08			15.24	V	224.2	2

REMARKS:

- Emission Level = Read Level+ Antenna Factor + Cable Loss- Preamp Factor
Margin value = Limit value – Emission Level.
- 5200MHz: Fundamental frequency.



CHANNEL	TX Channel 48	DETECTOR FUNCTION	Peak (PK)
FREQUENCY RANGE	1GHz ~ 40GHz		Average (AV)

ANTENNA POLARITY & TEST DISTANCE: HORIZONTAL AT 3 M

Rg	Frequency [MHz]	AVG Level [dBμV/m]	AVG Limit [dBμV/m]	AVG Margin [dB]	Correction [dB]	Polarization	Azimuth [deg]	Antenna Height [m]
3	5,145.500	35.74	54.00	18.26	15.02	H	1	1
3	5,150.000	35.64	54.00	18.36	15.02	H	235.1	1
3	5,242.500	87.34			15.17	H	114.2	1

Rg	Frequency [MHz]	PK+ Level [dBμV/m]	PK+ Limit [dBμV/m]	PK+ Margin [dB]	Correction [dB]	Polarization	Azimuth [deg]	Antenna Height [m]
3	5,139.000	50.56	74.00	23.44	15.01	H	28.2	2
3	5,150.000	49.23	74.00	24.77	15.02	H	280.5	1
3	5,239.000	97.13			15.19	H	219.4	2

ANTENNA POLARITY & TEST DISTANCE: VERTICAL AT 3 M

Rg	Frequency [MHz]	AVG Level [dBμV/m]	AVG Limit [dBμV/m]	AVG Margin [dB]	Correction [dB]	Polarization	Azimuth [deg]	Antenna Height [m]
3	5,148.500	35.74	54.00	18.26	15.02	V	297.2	1
3	5,150.000	35.64	54.00	18.36	15.02	V	5.1	1
3	5,242.500	83.59			15.17	V	241	2

Rg	Frequency [MHz]	PK+ Level [dBμV/m]	PK+ Limit [dBμV/m]	PK+ Margin [dB]	Correction [dB]	Polarization	Azimuth [deg]	Antenna Height [m]
3	5,120.500	51.45	74.00	22.55	15.00	V	184.9	1
3	5,150.000	49.38	74.00	24.62	15.02	V	217	2
3	5,245.000	92.50			15.16	V	90.5	1

REMARKS:

- Emission Level = Read Level+ Antenna Factor + Cable Loss- Preamp Factor
Margin value = Limit value – Emission Level.
- 5240MHz: Fundamental frequency.



802.11n (20MHz)

CHANNEL	TX Channel 36	DETECTOR FUNCTION	Peak (PK)
FREQUENCY RANGE	1GHz ~ 40GHz		Average (AV)

ANTENNA POLARITY & TEST DISTANCE: HORIZONTAL AT 3 M

Rg	Frequency [MHz]	AVG Level [dBμV/m]	AVG Limit [dBμV/m]	AVG Margin [dB]	Correction [dB]	Polarization	Azimuth [deg]	Antenna Height [m]
1	5,149.000	36.05	54.00	17.95	15.02	H	141.8	1
1	5,150.000	36.03	54.00	17.97	15.02	H	141.8	1
1	5,184.000	87.16			15.17	H	220.6	2

Rg	Frequency [MHz]	PK+ Level [dBμV/m]	PK+ Limit [dBμV/m]	PK+ Margin [dB]	Correction [dB]	Polarization	Azimuth [deg]	Antenna Height [m]
1	5,119.500	51.02	74.00	22.98	15.00	H	12.8	2
1	5,150.000	50.11	74.00	23.89	15.02	H	139.4	1
1	5,181.000	98.91			15.16	H	139.4	1

ANTENNA POLARITY & TEST DISTANCE: VERTICAL AT 3 M

Rg	Frequency [MHz]	AVG Level [dBμV/m]	AVG Limit [dBμV/m]	AVG Margin [dB]	Correction [dB]	Polarization	Azimuth [deg]	Antenna Height [m]
1	5,124.000	36.52	54.00	17.48	15.00	V	2.2	2
1	5,150.000	36.30	54.00	17.70	15.02	V	2.2	2
1	5,178.000	88.65			15.14	V	221.8	2

Rg	Frequency [MHz]	PK+ Level [dBμV/m]	PK+ Limit [dBμV/m]	PK+ Margin [dB]	Correction [dB]	Polarization	Azimuth [deg]	Antenna Height [m]
1	5,126.500	51.35	74.00	22.65	15.00	V	0.9	2
1	5,150.000	50.09	74.00	23.91	15.02	V	23.7	2
1	5,175.000	100.27			15.12	V	317.6	2

REMARKS:

- Emission Level = Read Level+ Antenna Factor + Cable Loss- Preamp Factor
Margin value = Limit value – Emission Level.
- 5180MHz: Fundamental frequency.



CHANNEL	TX Channel 40	DETECTOR FUNCTION	Peak (PK)
FREQUENCY RANGE	1GHz ~ 40GHz		Average (AV)

ANTENNA POLARITY & TEST DISTANCE: HORIZONTAL AT 3 M

Rg	Frequency [MHz]	AVG Level [dBμV/m]	AVG Limit [dBμV/m]	AVG Margin [dB]	Correction [dB]	Polarization	Azimuth [deg]	Antenna Height [m]
2	5,112.500	36.26	54.00	17.74	14.99	H	139.4	1
2	5,150.000	35.97	54.00	18.03	15.02	H	90.4	1
2	5,195.000	87.53			15.24	H	220.6	2

Rg	Frequency [MHz]	PK+ Level [dBμV/m]	PK+ Limit [dBμV/m]	PK+ Margin [dB]	Correction [dB]	Polarization	Azimuth [deg]	Antenna Height [m]
2	5,139.000	50.73	74.00	23.27	15.01	H	354.9	2
2	5,150.000	50.02	74.00	23.98	15.02	H	187.2	1
2	5,205.000	98.76			15.27	H	220.6	2

ANTENNA POLARITY & TEST DISTANCE: VERTICAL AT 3 M

Rg	Frequency [MHz]	AVG Level [dBμV/m]	AVG Limit [dBμV/m]	AVG Margin [dB]	Correction [dB]	Polarization	Azimuth [deg]	Antenna Height [m]
2	5,127.000	36.27	54.00	17.73	15.00	V	221.8	2
2	5,150.000	36.13	54.00	17.87	15.02	V	138.2	1
2	5,192.000	88.94			15.22	V	221.8	2

Rg	Frequency [MHz]	PK+ Level [dBμV/m]	PK+ Limit [dBμV/m]	PK+ Margin [dB]	Correction [dB]	Polarization	Azimuth [deg]	Antenna Height [m]
2	5,121.500	50.87	74.00	23.13	15.00	V	221.8	2
2	5,150.000	49.85	74.00	24.15	15.02	V	349.4	1
2	5,192.500	100.61			15.22	V	221.8	2

REMARKS:

- Emission Level = Read Level+ Antenna Factor + Cable Loss- Preamp Factor
Margin value = Limit value – Emission Level.
- 5200MHz: Fundamental frequency.



CHANNEL	TX Channel 48	DETECTOR FUNCTION	Peak (PK)
FREQUENCY RANGE	1GHz ~ 40GHz		Average (AV)

ANTENNA POLARITY & TEST DISTANCE: HORIZONTAL AT 3 M

Rg	Frequency [MHz]	AVG Level [dBμV/m]	AVG Limit [dBμV/m]	AVG Margin [dB]	Correction [dB]	Polarization	Azimuth [deg]	Antenna Height [m]
3	5,116.500	35.93	54.00	18.07	14.99	H	1	1
3	5,150.000	35.75	54.00	18.25	15.02	H	350.1	1
3	5,242.500	86.44			15.17	H	114.3	1

Rg	Frequency [MHz]	PK+ Level [dBμV/m]	PK+ Limit [dBμV/m]	PK+ Margin [dB]	Correction [dB]	Polarization	Azimuth [deg]	Antenna Height [m]
3	5,126.000	50.67	74.00	23.33	15.00	H	330.6	1
3	5,150.000	49.49	74.00	24.51	15.02	H	2.8	2
3	5,243.000	99.27			15.17	H	220.6	2

ANTENNA POLARITY & TEST DISTANCE: VERTICAL AT 3 M

Rg	Frequency [MHz]	AVG Level [dBμV/m]	AVG Limit [dBμV/m]	AVG Margin [dB]	Correction [dB]	Polarization	Azimuth [deg]	Antenna Height [m]
3	5,112.500	36.08	54.00	17.92	14.99	V	176.5	2
3	5,150.000	35.86	54.00	18.14	15.02	V	176.5	2
3	5,238.500	87.25			15.19	V	116.6	2

Rg	Frequency [MHz]	PK+ Level [dBμV/m]	PK+ Limit [dBμV/m]	PK+ Margin [dB]	Correction [dB]	Polarization	Azimuth [deg]	Antenna Height [m]
3	5,119.500	51.15	74.00	22.85	15.00	V	355	1
3	5,150.000	49.73	74.00	24.27	15.02	V	187.2	2
3	5,244.000	101.15			15.17	V	78.4	1

REMARKS:

- Emission Level = Read Level+ Antenna Factor + Cable Loss- Preamp Factor
Margin value = Limit value – Emission Level.
- 5240MHz: Fundamental frequency.



802.11n (40MHz)

CHANNEL	TX Channel 38	DETECTOR FUNCTION	Peak (PK)
FREQUENCY RANGE	1GHz ~ 40GHz		Average (AV)

ANTENNA POLARITY & TEST DISTANCE: HORIZONTAL AT 3 M

Rg	Frequency [MHz]	AVG Level [dBμV/m]	AVG Limit [dBμV/m]	AVG Margin [dB]	Correction [dB]	Polarization	Azimuth [deg]	Antenna Height [m]
1	5,144.000	38.27	54.00	15.73	12.73	H	289.8	1
1	5,150.000	38.99	54.00	15.01	12.75	H	355.6	2
1	5,188.000	93.64			12.90	H	5	1

Rg	Frequency [MHz]	PK+ Level [dBμV/m]	PK+ Limit [dBμV/m]	PK+ Margin [dB]	Correction [dB]	Polarization	Azimuth [deg]	Antenna Height [m]
1	5,114.000	52.91	74.00	21.09	12.64	H	133.6	2
1	5,150.000	52.22	74.00	21.78	12.75	H	355.1	2
1	5,188.500	104.25			12.90	H	5	1

ANTENNA POLARITY & TEST DISTANCE: VERTICAL AT 3 M

Rg	Frequency [MHz]	AVG Level [dBμV/m]	AVG Limit [dBμV/m]	AVG Margin [dB]	Correction [dB]	Polarization	Azimuth [deg]	Antenna Height [m]
1	5,143.000	39.60	54.00	14.40	12.73	V	355	2
1	5,150.000	39.99	54.00	14.01	12.75	V	355	2
1	5,188.500	94.60			12.90	V	66.6	2

Rg	Frequency [MHz]	PK+ Level [dBμV/m]	PK+ Limit [dBμV/m]	PK+ Margin [dB]	Correction [dB]	Polarization	Azimuth [deg]	Antenna Height [m]
1	5,144.500	53.55	74.00	20.45	12.73	V	355	2
1	5,150.000	54.06	74.00	19.94	12.75	V	355	2
1	5,184.500	103.99			12.89	V	135.9	2

REMARKS:

- Emission Level = Read Level+ Antenna Factor + Cable Loss- Preamp Factor
Margin value = Limit value – Emission Level.
- 5190MHz: Fundamental frequency.



CHANNEL	TX Channel 46	DETECTOR FUNCTION	Peak (PK)
FREQUENCY RANGE	1GHz ~ 40GHz		Average (AV)

ANTENNA POLARITY & TEST DISTANCE: HORIZONTAL AT 3 M

Rg	Frequency [MHz]	AVG Level [dBμV/m]	AVG Limit [dBμV/m]	AVG Margin [dB]	Correction [dB]	Polarization	Azimuth [deg]	Antenna Height [m]
2	5,135.000	36.65	54.00	17.35	12.70	H	313.8	1
2	5,150.000	36.35	54.00	17.65	12.75	H	65.4	2
2	5,223.500	90.24			12.94	H	355	2

Rg	Frequency [MHz]	PK+ Level [dBμV/m]	PK+ Limit [dBμV/m]	PK+ Margin [dB]	Correction [dB]	Polarization	Azimuth [deg]	Antenna Height [m]
2	5,122.000	50.25	74.00	23.75	12.66	H	118.9	1
2	5,150.000	49.37	74.00	24.63	12.75	H	1	2
2	5,218.500	104.76			12.94	H	5	1

ANTENNA POLARITY & TEST DISTANCE: VERTICAL AT 3 M

Rg	Frequency [MHz]	AVG Level [dBμV/m]	AVG Limit [dBμV/m]	AVG Margin [dB]	Correction [dB]	Polarization	Azimuth [deg]	Antenna Height [m]
2	5,132.000	36.38	54.00	17.62	12.69	V	94	2
2	5,150.000	35.89	54.00	18.11	12.75	V	94	2
2	5,235.000	89.89			12.94	V	1.8	2

Rg	Frequency [MHz]	PK+ Level [dBμV/m]	PK+ Limit [dBμV/m]	PK+ Margin [dB]	Correction [dB]	Polarization	Azimuth [deg]	Antenna Height [m]
2	5,112.000	50.72	74.00	23.28	12.64	V	355	2
2	5,150.000	49.67	74.00	24.33	12.75	V	191	2
2	5,219.000	103.63			12.94	V	75	2

REMARKS:

- Emission Level = Read Level+ Antenna Factor + Cable Loss- Preamp Factor
Margin value = Limit value – Emission Level.
- 5230MHz: Fundamental frequency.



802.11ac (20MHz)

CHANNEL	TX Channel 36	DETECTOR FUNCTION	Peak (PK)
FREQUENCY RANGE	1GHz ~ 40GHz		Average (AV)

ANTENNA POLARITY & TEST DISTANCE: HORIZONTAL AT 3 M

Rg	Frequency [MHz]	AVG Level [dBμV/m]	AVG Limit [dBμV/m]	AVG Margin [dB]	Correction [dB]	Polarization	Azimuth [deg]	Antenna Height [m]
1	5,149.000	36.01	54.00	17.99	15.02	H	140.5	1
1	5,150.000	35.98	54.00	18.02	15.02	H	140.5	1
1	5,183.000	87.20			15.17	H	140.5	1

Rg	Frequency [MHz]	PK+ Level [dBμV/m]	PK+ Limit [dBμV/m]	PK+ Margin [dB]	Correction [dB]	Polarization	Azimuth [deg]	Antenna Height [m]
1	5,114.000	51.13	74.00	22.87	14.99	H	187.2	1
1	5,150.000	50.26	74.00	23.74	15.02	H	229	2
1	5,182.000	97.46			15.16	H	138.2	1

ANTENNA POLARITY & TEST DISTANCE: VERTICAL AT 3 M

Rg	Frequency [MHz]	AVG Level [dBμV/m]	AVG Limit [dBμV/m]	AVG Margin [dB]	Correction [dB]	Polarization	Azimuth [deg]	Antenna Height [m]
1	5,117.000	36.00	54.00	18.00	14.99	V	184.9	1
1	5,150.000	35.84	54.00	18.16	15.02	V	355.6	1
1	5,179.000	88.31			15.14	V	260.2	1

Rg	Frequency [MHz]	PK+ Level [dBμV/m]	PK+ Limit [dBμV/m]	PK+ Margin [dB]	Correction [dB]	Polarization	Azimuth [deg]	Antenna Height [m]
1	5,128.500	50.91	74.00	23.09	15.00	V	171.8	1
1	5,150.000	50.67	74.00	23.33	15.02	V	231.4	2
1	5,179.000	100.78			15.14	V	5.1	2

REMARKS:

- Emission Level = Read Level+ Antenna Factor + Cable Loss- Preamp Factor
Margin value = Limit value – Emission Level.
- 5180MHz: Fundamental frequency.



CHANNEL	TX Channel 40	DETECTOR FUNCTION	Peak (PK)
FREQUENCY RANGE	1GHz ~ 40GHz		Average (AV)

ANTENNA POLARITY & TEST DISTANCE: HORIZONTAL AT 3 M

Rg	Frequency [MHz]	AVG Level [dBμV/m]	AVG Limit [dBμV/m]	AVG Margin [dB]	Correction [dB]	Polarization	Azimuth [deg]	Antenna Height [m]
2	5,117.500	35.97	54.00	18.03	14.99	H	180	2
2	5,150.000	35.83	54.00	18.17	15.02	H	242.2	2
2	5,192.500	85.04			15.22	H	119.1	1

Rg	Frequency [MHz]	PK+ Level [dBμV/m]	PK+ Limit [dBμV/m]	PK+ Margin [dB]	Correction [dB]	Polarization	Azimuth [deg]	Antenna Height [m]
2	5,147.000	50.58	74.00	23.42	15.02	H	141.8	1
2	5,150.000	50.38	74.00	23.62	15.02	H	141.8	1
2	5,202.000	98.17			15.27	H	218.2	2

ANTENNA POLARITY & TEST DISTANCE: VERTICAL AT 3 M

Rg	Frequency [MHz]	AVG Level [dBμV/m]	AVG Limit [dBμV/m]	AVG Margin [dB]	Correction [dB]	Polarization	Azimuth [deg]	Antenna Height [m]
2	5,118.500	35.98	54.00	18.02	14.99	V	188.5	2
2	5,150.000	35.82	54.00	18.18	15.02	V	188.5	2
2	5,202.000	89.14			15.27	V	125.1	2

Rg	Frequency [MHz]	PK+ Level [dBμV/m]	PK+ Limit [dBμV/m]	PK+ Margin [dB]	Correction [dB]	Polarization	Azimuth [deg]	Antenna Height [m]
2	5,113.000	50.83	74.00	23.17	14.99	V	43.8	2
2	5,150.000	49.48	74.00	24.52	15.02	V	125	1
2	5,203.000	100.52			15.27	V	77.1	1

REMARKS:

- Emission Level = Read Level+ Antenna Factor + Cable Loss- Preamp Factor
Margin value = Limit value – Emission Level.
- 5200MHz: Fundamental frequency.



CHANNEL	TX Channel 48	DETECTOR FUNCTION	Peak (PK)
FREQUENCY RANGE	1GHz ~ 40GHz		Average (AV)

ANTENNA POLARITY & TEST DISTANCE: HORIZONTAL AT 3 M

Rg	Frequency [MHz]	AVG Level [dBμV/m]	AVG Limit [dBμV/m]	AVG Margin [dB]	Correction [dB]	Polarization	Azimuth [deg]	Antenna Height [m]
3	5,124.000	35.94	54.00	18.06	15.00	H	181.2	2
3	5,150.000	35.78	54.00	18.22	15.02	H	1	1
3	5,241.500	84.95			15.18	H	178.9	1

Rg	Frequency [MHz]	PK+ Level [dBμV/m]	PK+ Limit [dBμV/m]	PK+ Margin [dB]	Correction [dB]	Polarization	Azimuth [deg]	Antenna Height [m]
3	5,148.500	51.29	74.00	22.71	15.02	H	177.7	1
3	5,150.000	49.61	74.00	24.39	15.02	H	1	2
3	5,242.500	98.00			15.17	H	219.4	2

ANTENNA POLARITY & TEST DISTANCE: VERTICAL AT 3 M

Rg	Frequency [MHz]	AVG Level [dBμV/m]	AVG Limit [dBμV/m]	AVG Margin [dB]	Correction [dB]	Polarization	Azimuth [deg]	Antenna Height [m]
3	5,118.500	36.09	54.00	17.91	14.99	V	182.5	2
3	5,150.000	35.83	54.00	18.17	15.02	V	354.9	1
3	5,237.000	86.52			15.20	V	231.4	1

Rg	Frequency [MHz]	PK+ Level [dBμV/m]	PK+ Limit [dBμV/m]	PK+ Margin [dB]	Correction [dB]	Polarization	Azimuth [deg]	Antenna Height [m]
3	5,125.500	51.47	74.00	22.53	15.00	V	359	1
3	5,150.000	49.45	74.00	24.55	15.02	V	334.2	2
3	5,242.500	100.13			15.17	V	76	1

REMARKS:

- Emission Level = Read Level+ Antenna Factor + Cable Loss- Preamp Factor
Margin value = Limit value – Emission Level.
- 5240MHz: Fundamental frequency.



802.11ac (40MHz)

CHANNEL	TX Channel 38	DETECTOR FUNCTION	Peak (PK)
FREQUENCY RANGE	1GHz ~ 40GHz		Average (AV)

ANTENNA POLARITY & TEST DISTANCE: HORIZONTAL AT 3 M

Rg	Frequency [MHz]	AVG Level [dBμV/m]	AVG Limit [dBμV/m]	AVG Margin [dB]	Correction [dB]	Polarization	Azimuth [deg]	Antenna Height [m]
1	5,149.500	36.29	54.00	17.71	15.02	H	139.4	1
1	5,150.000	36.40	54.00	17.60	15.02	H	139.4	1
1	5,185.000	85.97			15.18	H	139.4	1

Rg	Frequency [MHz]	PK+ Level [dBμV/m]	PK+ Limit [dBμV/m]	PK+ Margin [dB]	Correction [dB]	Polarization	Azimuth [deg]	Antenna Height [m]
1	5,119.500	51.30	74.00	22.70	15.00	H	236.3	1
1	5,150.000	50.19	74.00	23.81	15.02	H	188.4	1
1	5,173.000	97.50			15.11	H	215.8	2

ANTENNA POLARITY & TEST DISTANCE: VERTICAL AT 3 M

Rg	Frequency [MHz]	AVG Level [dBμV/m]	AVG Limit [dBμV/m]	AVG Margin [dB]	Correction [dB]	Polarization	Azimuth [deg]	Antenna Height [m]
1	5,149.000	36.47	54.00	17.53	15.02	V	58	2
1	5,150.000	36.41	54.00	17.59	15.02	V	58	2
1	5,183.000	85.86			15.17	V	5.2	1

Rg	Frequency [MHz]	PK+ Level [dBμV/m]	PK+ Limit [dBμV/m]	PK+ Margin [dB]	Correction [dB]	Polarization	Azimuth [deg]	Antenna Height [m]
1	5,146.000	52.49	74.00	21.51	15.02	V	218.2	2
1	5,150.000	51.16	74.00	22.84	15.02	V	218.2	2
1	5,181.000	99.45			15.16	V	218.2	2

REMARKS:

- Emission Level = Read Level+ Antenna Factor + Cable Loss- Preamp Factor
Margin value = Limit value – Emission Level.
- 5190MHz: Fundamental frequency.



CHANNEL	TX Channel 46	DETECTOR FUNCTION	Peak (PK)
FREQUENCY RANGE	1GHz ~ 40GHz		Average (AV)

ANTENNA POLARITY & TEST DISTANCE: HORIZONTAL AT 3 M

Rg	Frequency [MHz]	AVG Level [dBμV/m]	AVG Limit [dBμV/m]	AVG Margin [dB]	Correction [dB]	Polarization	Azimuth [deg]	Antenna Height [m]
2	5,113.500	36.27	54.00	17.73	14.99	H	217	2
2	5,150.000	35.68	54.00	18.32	15.02	H	1	1
2	5,226.500	85.02			15.24	H	140.6	1

Rg	Frequency [MHz]	PK+ Level [dBμV/m]	PK+ Limit [dBμV/m]	PK+ Margin [dB]	Correction [dB]	Polarization	Azimuth [deg]	Antenna Height [m]
2	5,123.500	50.90	74.00	23.10	15.00	H	1	2
2	5,150.000	49.65	74.00	24.35	15.02	H	1	1
2	5,227.500	96.92			15.24	H	310.3	2

ANTENNA POLARITY & TEST DISTANCE: VERTICAL AT 3 M

Rg	Frequency [MHz]	AVG Level [dBμV/m]	AVG Limit [dBμV/m]	AVG Margin [dB]	Correction [dB]	Polarization	Azimuth [deg]	Antenna Height [m]
2	5,118.500	36.42	54.00	17.58	14.99	V	219.4	2
2	5,150.000	35.71	54.00	18.29	15.02	V	5.2	1
2	5,228.500	85.62			15.23	V	146.6	1

Rg	Frequency [MHz]	PK+ Level [dBμV/m]	PK+ Limit [dBμV/m]	PK+ Margin [dB]	Correction [dB]	Polarization	Azimuth [deg]	Antenna Height [m]
2	5,126.500	50.94	74.00	23.06	15.00	V	92.9	1
2	5,150.000	49.64	74.00	24.36	15.02	V	172.8	2
2	5,221.000	98.05			15.26	V	220.6	2

REMARKS:

1. Emission Level = Read Level+ Antenna Factor + Cable Loss- Preamp Factor
Margin value = Limit value – Emission Level.
2. 5230MHz: Fundamental frequency.



802.11ac (80MHz)

CHANNEL	TX Channel 42	DETECTOR FUNCTION	Peak (PK)
FREQUENCY RANGE	1GHz ~ 40GHz		Average (AV)

ANTENNA POLARITY & TEST DISTANCE: HORIZONTAL AT 3 M

Rg	Frequency [MHz]	AVG Level [dBμV/m]	AVG Limit [dBμV/m]	AVG Margin [dB]	Correction [dB]	Polarization	Azimuth [deg]	Antenna Height [m]
1	5,121.050	39.12	54.00	14.88	12.66	H	5	1
1	5,150.000	37.94	54.00	16.06	12.75	H	5	1
1	5,236.650	85.83			12.94	H	5	1

Rg	Frequency [MHz]	PK+ Level [dBμV/m]	PK+ Limit [dBμV/m]	PK+ Margin [dB]	Correction [dB]	Polarization	Azimuth [deg]	Antenna Height [m]
1	5,127.000	52.88	74.00	21.12	12.68	H	83	1
1	5,150.000	51.77	74.00	22.23	12.75	H	259.8	1
1	5,185.230	100.40			12.89	H	4.9	1

ANTENNA POLARITY & TEST DISTANCE: VERTICAL AT 3 M

Rg	Frequency [MHz]	AVG Level [dBμV/m]	AVG Limit [dBμV/m]	AVG Margin [dB]	Correction [dB]	Polarization	Azimuth [deg]	Antenna Height [m]
1	5,133.800	39.85	54.00	14.15	12.70	V	355	2
1	5,150.000	38.84	54.00	15.16	12.75	V	359	2
1	5,240.475	86.67			12.94	V	355	2

Rg	Frequency [MHz]	PK+ Level [dBμV/m]	PK+ Limit [dBμV/m]	PK+ Margin [dB]	Correction [dB]	Polarization	Azimuth [deg]	Antenna Height [m]
1	5,132.525	55.82	74.00	18.18	12.70	V	355.7	2
1	5,150.000	54.09	74.00	19.91	12.75	V	355.7	2
1	5,192.875	97.95			12.92	V	359	2

REMARKS:

- Emission Level = Read Level+ Antenna Factor + Cable Loss- Preamp Factor
Margin value = Limit value – Emission Level.
- 5210MHz: Fundamental frequency.



802.11ax (20MHz)

CHANNEL	TX Channel 36	DETECTOR FUNCTION	Peak (PK)
FREQUENCY RANGE	1GHz ~ 40GHz		Average (AV)

ANTENNA POLARITY & TEST DISTANCE: HORIZONTAL AT 3 M

Rg	Frequency [MHz]	AVG Level [dBμV/m]	AVG Limit [dBμV/m]	AVG Margin [dB]	Correction [dB]	Polarization	Azimuth [deg]	Antenna Height [m]
1	5,131.000	36.21	54.00	17.79	12.69	H	268.3	1
1	5,150.000	35.78	54.00	18.22	12.75	H	4.3	1
1	5,188.000	85.97			12.90	H	355	2

Rg	Frequency [MHz]	PK+ Level [dBμV/m]	PK+ Limit [dBμV/m]	PK+ Margin [dB]	Correction [dB]	Polarization	Azimuth [deg]	Antenna Height [m]
1	5,143.500	51.05	74.00	22.95	12.73	H	4.4	1
1	5,150.000	50.68	74.00	23.32	12.75	H	287.4	1
1	5,173.000	109.68			12.85	H	287.4	1

ANTENNA POLARITY & TEST DISTANCE: VERTICAL AT 3 M

Rg	Frequency [MHz]	AVG Level [dBμV/m]	AVG Limit [dBμV/m]	AVG Margin [dB]	Correction [dB]	Polarization	Azimuth [deg]	Antenna Height [m]
1	5,130.000	37.32	54.00	16.68	12.69	V	90.5	2
1	5,150.000	36.57	54.00	17.43	12.75	V	1	2
1	5,175.000	93.41			12.86	V	359	2

Rg	Frequency [MHz]	PK+ Level [dBμV/m]	PK+ Limit [dBμV/m]	PK+ Margin [dB]	Correction [dB]	Polarization	Azimuth [deg]	Antenna Height [m]
1	5,144.000	51.68	74.00	22.32	12.73	V	359	1
1	5,150.000	51.43	74.00	22.57	12.75	V	355	2
1	5,185.500	108.93			12.89	V	2.2	2

REMARKS:

- Emission Level = Read Level+ Antenna Factor + Cable Loss- Preamp Factor
Margin value = Limit value – Emission Level.
- 5180MHz: Fundamental frequency.



CHANNEL	TX Channel 40	DETECTOR FUNCTION	Peak (PK)
FREQUENCY RANGE	1GHz ~ 40GHz		Average (AV)

ANTENNA POLARITY & TEST DISTANCE: HORIZONTAL AT 3 M

Rg	Frequency [MHz]	AVG Level [dBμV/m]	AVG Limit [dBμV/m]	AVG Margin [dB]	Correction [dB]	Polarization	Azimuth [deg]	Antenna Height [m]
2	5,134.000	35.85	54.00	18.15	12.70	H	4.3	1
2	5,150.000	35.77	54.00	18.23	12.75	H	355.6	2
2	5,201.000	83.52			12.95	H	4.3	1

Rg	Frequency [MHz]	PK+ Level [dBμV/m]	PK+ Limit [dBμV/m]	PK+ Margin [dB]	Correction [dB]	Polarization	Azimuth [deg]	Antenna Height [m]
2	5,143.000	51.16	74.00	22.84	12.73	H	30.7	2
2	5,150.000	50.15	74.00	23.85	12.75	H	2.3	2
2	5,203.000	107.85			12.95	H	355	2

ANTENNA POLARITY & TEST DISTANCE: VERTICAL AT 3 M

Rg	Frequency [MHz]	AVG Level [dBμV/m]	AVG Limit [dBμV/m]	AVG Margin [dB]	Correction [dB]	Polarization	Azimuth [deg]	Antenna Height [m]
2	5,142.500	36.45	54.00	17.55	12.72	V	355.1	2
2	5,150.000	36.36	54.00	17.64	12.75	V	1	2
2	5,205.000	93.94			12.94	V	359	2

Rg	Frequency [MHz]	PK+ Level [dBμV/m]	PK+ Limit [dBμV/m]	PK+ Margin [dB]	Correction [dB]	Polarization	Azimuth [deg]	Antenna Height [m]
2	5,110.000	51.93	74.00	22.07	12.64	V	355	2
2	5,150.000	49.82	74.00	24.18	12.75	V	198.2	2
2	5,195.500	108.85			12.93	V	2.4	2

REMARKS:

- Emission Level = Read Level+ Antenna Factor + Cable Loss- Preamp Factor
Margin value = Limit value – Emission Level.
- 5200MHz: Fundamental frequency.



CHANNEL	TX Channel 48	DETECTOR FUNCTION	Peak (PK)
FREQUENCY RANGE	1GHz ~ 40GHz		Average (AV)

ANTENNA POLARITY & TEST DISTANCE: HORIZONTAL AT 3 M

Rg	Frequency [MHz]	AVG Level [dBµV/m]	AVG Limit [dBµV/m]	AVG Margin [dB]	Correction [dB]	Polarization	Azimuth [deg]	Antenna Height [m]
3	5,142.000	35.78	54.00	18.22	12.72	H	355	2
3	5,150.000	35.55	54.00	18.45	12.75	H	359	1
3	5,239.000	82.56			12.94	H	5	1

Rg	Frequency [MHz]	PK+ Level [dBµV/m]	PK+ Limit [dBµV/m]	PK+ Margin [dB]	Correction [dB]	Polarization	Azimuth [deg]	Antenna Height [m]
3	5,133.500	50.97	74.00	23.03	12.70	H	355	2
3	5,150.000	49.86	74.00	24.14	12.75	H	295.7	1
3	5,243.000	106.53			12.94	H	355	2

ANTENNA POLARITY & TEST DISTANCE: VERTICAL AT 3 M

Rg	Frequency [MHz]	AVG Level [dBµV/m]	AVG Limit [dBµV/m]	AVG Margin [dB]	Correction [dB]	Polarization	Azimuth [deg]	Antenna Height [m]
3	5,127.500	36.43	54.00	17.57	12.68	V	7.1	1
3	5,150.000	35.98	54.00	18.02	12.75	V	1	2
3	5,234.500	92.15			12.94	V	1	2

Rg	Frequency [MHz]	PK+ Level [dBµV/m]	PK+ Limit [dBµV/m]	PK+ Margin [dB]	Correction [dB]	Polarization	Azimuth [deg]	Antenna Height [m]
3	5,116.500	50.98	74.00	23.02	12.65	V	355.8	2
3	5,150.000	50.10	74.00	23.90	12.75	V	359	2
3	5,235.500	106.86			12.94	V	0.9	2

REMARKS:

- Emission Level = Read Level+ Antenna Factor + Cable Loss- Preamp Factor
Margin value = Limit value – Emission Level.
- 5240MHz: Fundamental frequency.



802.11ax (40MHz)

CHANNEL	TX Channel 38	DETECTOR FUNCTION	Peak (PK)
FREQUENCY RANGE	1GHz ~ 40GHz		Average (AV)

ANTENNA POLARITY & TEST DISTANCE: HORIZONTAL AT 3 M

Rg	Frequency [MHz]	AVG Level [dBμV/m]	AVG Limit [dBμV/m]	AVG Margin [dB]	Correction [dB]	Polarization	Azimuth [deg]	Antenna Height [m]
1	5,147.000	37.88	54.00	16.12	12.74	H	5	1
1	5,150.000	37.48	54.00	16.52	12.75	H	5	1
1	5,195.500	85.84			12.93	H	355.7	2

Rg	Frequency [MHz]	PK+ Level [dBμV/m]	PK+ Limit [dBμV/m]	PK+ Margin [dB]	Correction [dB]	Polarization	Azimuth [deg]	Antenna Height [m]
1	5,148.500	52.52	74.00	21.48	12.74	H	280.2	1
1	5,150.000	53.00	74.00	21.00	12.75	H	280.2	1
1	5,189.500	104.97			12.91	H	5	1

ANTENNA POLARITY & TEST DISTANCE: VERTICAL AT 3 M

Rg	Frequency [MHz]	AVG Level [dBμV/m]	AVG Limit [dBμV/m]	AVG Margin [dB]	Correction [dB]	Polarization	Azimuth [deg]	Antenna Height [m]
1	5,144.000	37.98	54.00	16.02	12.73	V	90.5	2
1	5,150.000	38.22	54.00	15.78	12.75	V	359	2
1	5,179.000	90.57			12.87	V	5.6	1

Rg	Frequency [MHz]	PK+ Level [dBμV/m]	PK+ Limit [dBμV/m]	PK+ Margin [dB]	Correction [dB]	Polarization	Azimuth [deg]	Antenna Height [m]
1	5,148.500	56.75	74.00	17.25	12.74	V	58.2	2
1	5,150.000	56.80	74.00	17.20	12.75	V	58.2	2
1	5,179.000	106.24			12.87	V	58.2	2

REMARKS:

- Emission Level = Read Level+ Antenna Factor + Cable Loss- Preamp Factor
Margin value = Limit value – Emission Level.
- 5190MHz: Fundamental frequency.



CHANNEL	TX Channel 46	DETECTOR FUNCTION	Peak (PK)
FREQUENCY RANGE	1GHz ~ 40GHz		Average (AV)

ANTENNA POLARITY & TEST DISTANCE: HORIZONTAL AT 3 M

Rg	Frequency [MHz]	AVG Level [dBμV/m]	AVG Limit [dBμV/m]	AVG Margin [dB]	Correction [dB]	Polarization	Azimuth [deg]	Antenna Height [m]
2	5,142.000	35.74	54.00	18.26	12.72	H	355.1	2
2	5,150.000	35.57	54.00	18.43	12.75	H	355.1	2
2	5,219.500	79.61			12.94	H	5	1

Rg	Frequency [MHz]	PK+ Level [dBμV/m]	PK+ Limit [dBμV/m]	PK+ Margin [dB]	Correction [dB]	Polarization	Azimuth [deg]	Antenna Height [m]
2	5,130.500	50.78	74.00	23.22	12.69	H	5.7	1
2	5,150.000	49.08	74.00	24.92	12.75	H	353.4	1
2	5,219.500	104.50			12.94	H	5.7	1

ANTENNA POLARITY & TEST DISTANCE: VERTICAL AT 3 M

Rg	Frequency [MHz]	AVG Level [dBμV/m]	AVG Limit [dBμV/m]	AVG Margin [dB]	Correction [dB]	Polarization	Azimuth [deg]	Antenna Height [m]
2	5,130.000	36.23	54.00	17.77	12.69	V	4.3	1
2	5,150.000	35.84	54.00	18.16	12.75	V	1	2
2	5,234.500	88.01			12.94	V	359	2

Rg	Frequency [MHz]	PK+ Level [dBμV/m]	PK+ Limit [dBμV/m]	PK+ Margin [dB]	Correction [dB]	Polarization	Azimuth [deg]	Antenna Height [m]
2	5,133.000	50.65	74.00	23.35	12.70	V	355	2
2	5,150.000	48.93	74.00	25.07	12.75	V	359	1
2	5,214.500	102.99			12.94	V	0.9	2

REMARKS:

- Emission Level = Read Level+ Antenna Factor + Cable Loss- Preamp Factor
Margin value = Limit value – Emission Level.
- 5230MHz: Fundamental frequency.



802.11ax (80MHz)

CHANNEL	TX Channel 42	DETECTOR FUNCTION	Peak (PK)
FREQUENCY RANGE	1GHz ~ 40GHz		Average (AV)

ANTENNA POLARITY & TEST DISTANCE: HORIZONTAL AT 3 M

Rg	Frequency [MHz]	AVG Level [dBμV/m]	AVG Limit [dBμV/m]	AVG Margin [dB]	Correction [dB]	Polarization	Azimuth [deg]	Antenna Height [m]
1	5,115.950	39.56	54.00	14.44	12.65	H	4.9	1
1	5,150.000	37.95	54.00	16.05	12.75	H	355.1	2
1	5,234.950	85.29			12.94	H	4.9	1

Rg	Frequency [MHz]	PK+ Level [dBμV/m]	PK+ Limit [dBμV/m]	PK+ Margin [dB]	Correction [dB]	Polarization	Azimuth [deg]	Antenna Height [m]
1	5,144.000	54.26	74.00	19.74	12.73	H	355.6	2
1	5,150.000	52.39	74.00	21.61	12.75	H	85.4	1
1	5,185.230	102.68			12.89	H	5	1

ANTENNA POLARITY & TEST DISTANCE: VERTICAL AT 3 M

Rg	Frequency [MHz]	AVG Level [dBμV/m]	AVG Limit [dBμV/m]	AVG Margin [dB]	Correction [dB]	Polarization	Azimuth [deg]	Antenna Height [m]
1	5,146.975	40.95	54.00	13.05	12.74	V	359	2
1	5,150.000	40.05	54.00	13.95	12.75	V	1	1
1	5,177.150	86.36			12.86	V	5	1

Rg	Frequency [MHz]	PK+ Level [dBμV/m]	PK+ Limit [dBμV/m]	PK+ Margin [dB]	Correction [dB]	Polarization	Azimuth [deg]	Antenna Height [m]
1	5,147.825	58.17	74.00	15.83	12.74	V	355.7	2
1	5,150.000	55.88	74.00	18.12	12.75	V	355.7	2
1	5,203.500	100.88			12.95	V	359	2

REMARKS:

- Emission Level = Read Level+ Antenna Factor + Cable Loss- Preamp Factor
Margin value = Limit value – Emission Level.
- 5210MHz: Fundamental frequency.



802.11ac (80MHz):

Worst case harmonic:

CHANNEL	TX Channel 42	DETECTOR FUNCTION	Peak (PK)
FREQUENCY RANGE	1GHz ~ 40GHz		Average (AV)

ANTENNA POLARITY & TEST DISTANCE: HORIZONTAL AT 3 M

Rg	Frequency [MHz]	PK+ Level [dBμV/m]	PK+ Limit [dBμV/m]	PK+ Margin [dB]	AVG Level [dBμV/m]	AVG Limit [dBμV/m]	AVG Margin [dB]	Correction [dB]	Polarization	Azimuth [deg]	Antenna Height [m]
4	10,420.000	44.74	74.00	29.26	33.79	54.00	20.21	11.38	H	1.4	2
4	15,630.000	45.81	74.00	28.19	36.08	54.00	17.92	15.59	H	1.4	2

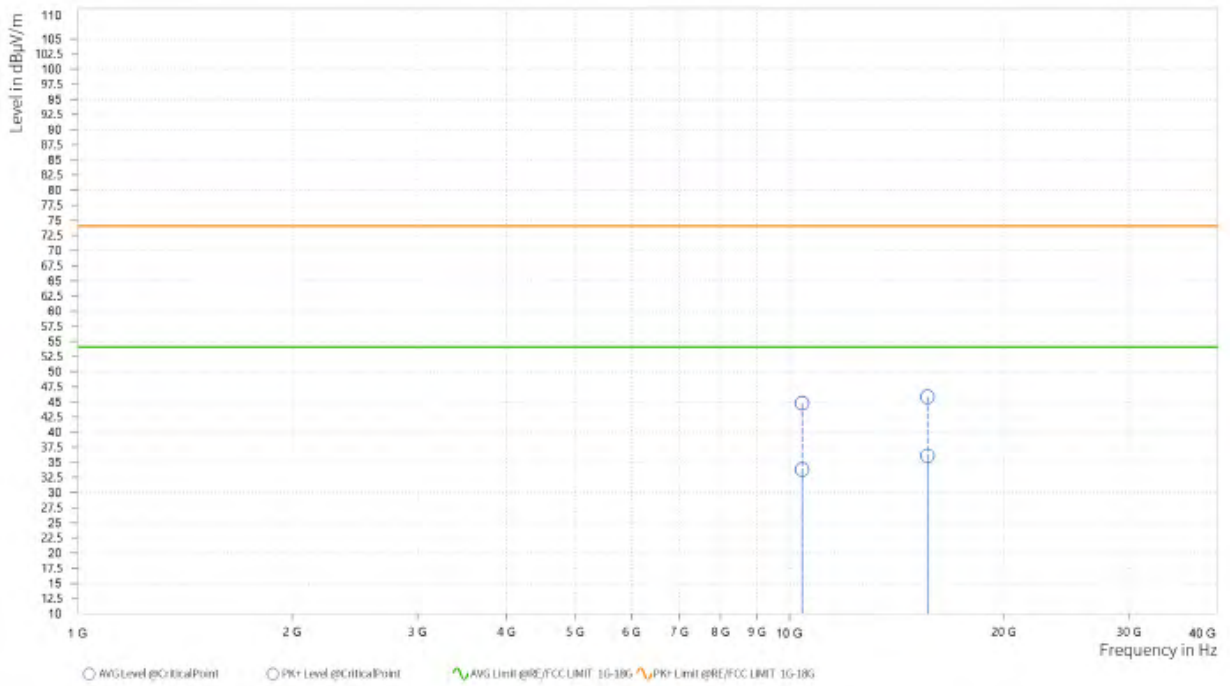



ANTENNA POLARITY & TEST DISTANCE: VERTICAL AT 3 M

Rg	Frequency [MHz]	PK+ Level [dBμV/m]	PK+ Limit [dBμV/m]	PK+ Margin [dB]	AVG Level [dBμV/m]	AVG Limit [dBμV/m]	AVG Margin [dB]	Correction [dB]	Polarization	Azimuth [deg]	Antenna Height [m]
4	10,420.000	44.42	74.00	29.58	33.49	54.00	20.51	11.38	V	359.1	1
4	15,630.000	46.69	74.00	27.31	35.97	54.00	18.03	15.59	V	359	2

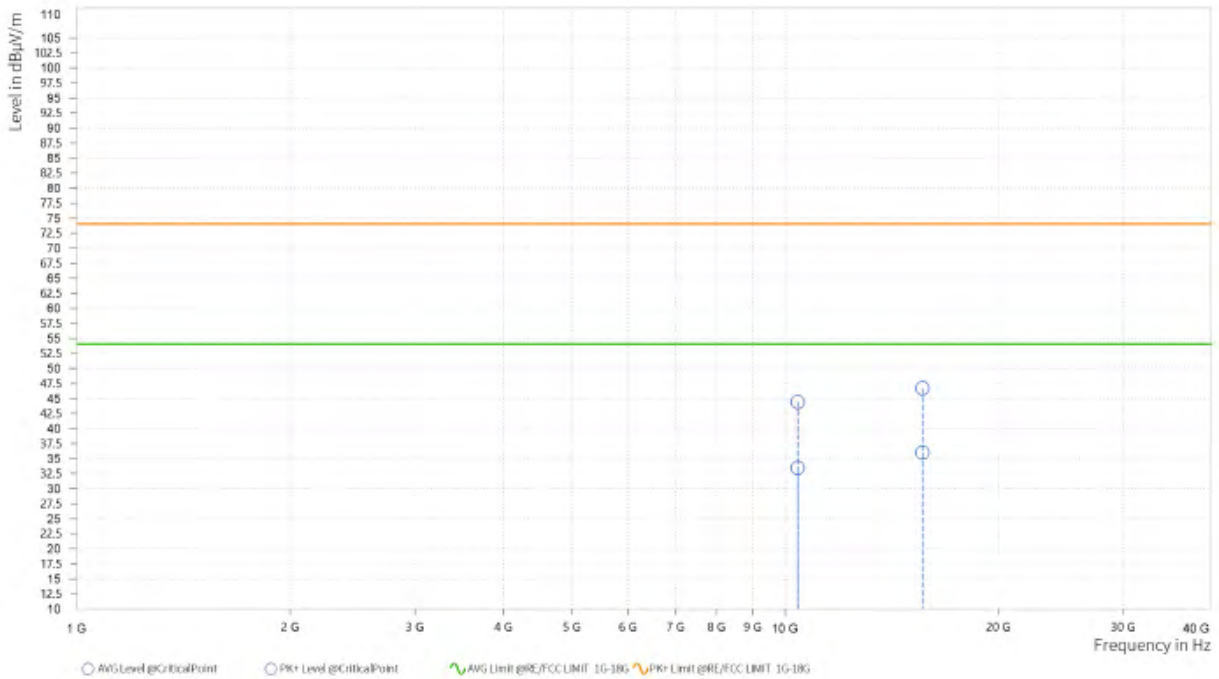

REMARKS:

- Emission Level = Read Level+ Antenna Factor + Cable Loss- Preamp Factor
Margin value = Limit value – Emission Level.
- 5210MHz: Fundamental frequency.



5G WIFI-RU

802.11ax (20MHz) (RU26):

CHANNEL	TX Channel 36	DETECTOR FUNCTION	Peak (PK)
FREQUENCY RANGE	1GHz ~ 40GHz		Average (AV)

ANTENNA POLARITY & TEST DISTANCE: HORIZONTAL AT 3 M

Rg	Frequency [MHz]	AVG Level [dBμV/m]	AVG Limit [dBμV/m]	AVG Margin [dB]	Correction [dB]	Polarization	Azimuth [deg]	Antenna Height [m]
1	5,122.500	36.01	54.00	17.99	15.00	H	187.2	1
1	5,150.000	35.82	54.00	18.18	15.02	H	221.8	2
1	5,171.500	90.02			15.10	H	139.4	1

Rg	Frequency [MHz]	PK+ Level [dBμV/m]	PK+ Limit [dBμV/m]	PK+ Margin [dB]	Correction [dB]	Polarization	Azimuth [deg]	Antenna Height [m]
1	5,142.000	51.20	74.00	22.80	15.01	H	42.5	1
1	5,150.000	50.26	74.00	23.74	15.02	H	1	1
1	5,172.000	101.53			15.10	H	269.6	2

ANTENNA POLARITY & TEST DISTANCE: VERTICAL AT 3 M

Rg	Frequency [MHz]	AVG Level [dBμV/m]	AVG Limit [dBμV/m]	AVG Margin [dB]	Correction [dB]	Polarization	Azimuth [deg]	Antenna Height [m]
1	5,123.000	35.99	54.00	18.01	15.00	V	205.1	2
1	5,150.000	35.80	54.00	18.20	15.02	V	1	1
1	5,171.500	89.81			15.10	V	205.1	2

Rg	Frequency [MHz]	PK+ Level [dBμV/m]	PK+ Limit [dBμV/m]	PK+ Margin [dB]	Correction [dB]	Polarization	Azimuth [deg]	Antenna Height [m]
1	5,141.500	50.94	74.00	23.06	15.01	V	359	1
1	5,150.000	51.14	74.00	22.86	15.02	V	355.5	2
1	5,172.000	101.82			15.10	V	223	2

REMARKS:

- Emission Level = Read Level+ Antenna Factor + Cable Loss- Preamp Factor
Margin value = Limit value – Emission Level.
- 5180MHz: Fundamental frequency.



CHANNEL	TX Channel 40	DETECTOR FUNCTION	Peak (PK)
FREQUENCY RANGE	1GHz ~ 40GHz		Average (AV)

ANTENNA POLARITY & TEST DISTANCE: HORIZONTAL AT 3 M

Rg	Frequency [MHz]	AVG Level [dBμV/m]	AVG Limit [dBμV/m]	AVG Margin [dB]	Correction [dB]	Polarization	Azimuth [deg]	Antenna Height [m]
2	5,112.000	36.00	54.00	18.00	14.99	H	1	1
2	5,150.000	35.84	54.00	18.16	15.02	H	242.2	2
2	5,199.500	86.80			15.26	H	242.2	2

Rg	Frequency [MHz]	PK+ Level [dBμV/m]	PK+ Limit [dBμV/m]	PK+ Margin [dB]	Correction [dB]	Polarization	Azimuth [deg]	Antenna Height [m]
2	5,116.000	51.43	74.00	22.57	14.99	H	359	2
2	5,150.000	49.62	74.00	24.38	15.02	H	3.3	2
2	5,201.000	95.24			15.27	H	127.4	2

ANTENNA POLARITY & TEST DISTANCE: VERTICAL AT 3 M

Rg	Frequency [MHz]	AVG Level [dBμV/m]	AVG Limit [dBμV/m]	AVG Margin [dB]	Correction [dB]	Polarization	Azimuth [deg]	Antenna Height [m]
2	5,118.000	36.02	54.00	17.98	14.99	V	9.4	2
2	5,150.000	35.84	54.00	18.16	15.02	V	1	1
2	5,199.500	88.28			15.26	V	243.4	2

Rg	Frequency [MHz]	PK+ Level [dBμV/m]	PK+ Limit [dBμV/m]	PK+ Margin [dB]	Correction [dB]	Polarization	Azimuth [deg]	Antenna Height [m]
2	5,142.000	51.04	74.00	22.96	15.01	V	269.6	2
2	5,150.000	50.54	74.00	23.46	15.02	V	359	1
2	5,201.000	99.25			15.27	V	139.4	1

REMARKS:

- Emission Level = Read Level+ Antenna Factor + Cable Loss- Preamp Factor
Margin value = Limit value – Emission Level.
- 5200MHz: Fundamental frequency.



CHANNEL	TX Channel 48	DETECTOR FUNCTION	Peak (PK)
FREQUENCY RANGE	1GHz ~ 40GHz		Average (AV)

ANTENNA POLARITY & TEST DISTANCE: HORIZONTAL AT 3 M

Rg	Frequency [MHz]	AVG Level [dBμV/m]	AVG Limit [dBμV/m]	AVG Margin [dB]	Correction [dB]	Polarization	Azimuth [deg]	Antenna Height [m]
3	5,118.000	36.02	54.00	17.98	14.99	H	1	1
3	5,150.000	35.87	54.00	18.13	15.02	H	1	1
3	5,248.500	88.73			15.15	H	116.7	1

Rg	Frequency [MHz]	PK+ Level [dBμV/m]	PK+ Limit [dBμV/m]	PK+ Margin [dB]	Correction [dB]	Polarization	Azimuth [deg]	Antenna Height [m]
3	5,148.000	51.34	74.00	22.66	15.02	H	169.4	2
3	5,150.000	50.00	74.00	24.00	15.02	H	218.2	2
3	5,248.500	97.89			15.15	H	141.8	1

ANTENNA POLARITY & TEST DISTANCE: VERTICAL AT 3 M

Rg	Frequency [MHz]	AVG Level [dBμV/m]	AVG Limit [dBμV/m]	AVG Margin [dB]	Correction [dB]	Polarization	Azimuth [deg]	Antenna Height [m]
3	5,118.000	36.03	54.00	17.97	14.99	V	237.5	2
3	5,150.000	35.86	54.00	18.14	15.02	V	1	1
3	5,248.500	85.03			15.15	V	237.5	2

Rg	Frequency [MHz]	PK+ Level [dBμV/m]	PK+ Limit [dBμV/m]	PK+ Margin [dB]	Correction [dB]	Polarization	Azimuth [deg]	Antenna Height [m]
3	5,126.000	50.97	74.00	23.03	15.00	V	269.6	2
3	5,150.000	49.78	74.00	24.22	15.02	V	43.8	1
3	5,248.500	101.65			15.15	V	223	2

REMARKS:

- Emission Level = Read Level+ Antenna Factor + Cable Loss- Preamp Factor
Margin value = Limit value – Emission Level.
- 5240MHz: Fundamental frequency.



Band 2
802.11a

CHANNEL	TX Channel 52	DETECTOR FUNCTION	Peak (PK)
FREQUENCY RANGE	1GHz ~ 40GHz		Average (AV)

ANTENNA POLARITY & TEST DISTANCE: HORIZONTAL AT 3 M

Rg	Frequency [MHz]	AVG Level [dBμV/m]	AVG Limit [dBμV/m]	AVG Margin [dB]	Correction [dB]	Polarization	Azimuth [deg]	Antenna Height [m]
4	5,262.000	82.68			15.11	H	185.9	2
4	5,350.000	35.72	54.00	18.28	15.18	H	359	2
4	5,352.000	35.71	54.00	18.29	15.18	H	359	2

Rg	Frequency [MHz]	PK+ Level [dBμV/m]	PK+ Limit [dBμV/m]	PK+ Margin [dB]	Correction [dB]	Polarization	Azimuth [deg]	Antenna Height [m]
4	5,259.000	98.82			15.12	H	199	2
4	5,350.000	49.30	74.00	24.70	15.18	H	281.6	1
4	5,380.000	50.82	74.00	23.18	15.19	H	138.2	1

ANTENNA POLARITY & TEST DISTANCE: VERTICAL AT 3 M

Rg	Frequency [MHz]	AVG Level [dBμV/m]	AVG Limit [dBμV/m]	AVG Margin [dB]	Correction [dB]	Polarization	Azimuth [deg]	Antenna Height [m]
4	5,266.000	81.98			15.10	V	174.1	1
4	5,350.000	35.67	54.00	18.33	15.18	V	114.3	1
4	5,351.500	35.69	54.00	18.31	15.18	V	354.8	2

Rg	Frequency [MHz]	PK+ Level [dBμV/m]	PK+ Limit [dBμV/m]	PK+ Margin [dB]	Correction [dB]	Polarization	Azimuth [deg]	Antenna Height [m]
4	5,258.500	94.19			15.12	V	184.9	1
4	5,350.000	49.87	74.00	24.13	15.18	V	354.9	2
4	5,385.500	50.85	74.00	23.15	15.20	V	355.8	1

REMARKS:

- Emission Level = Read Level+ Antenna Factor + Cable Loss- Preamp Factor
Margin value = Limit value – Emission Level.
- 5260MHz: Fundamental frequency.



CHANNEL	TX Channel 60	DETECTOR FUNCTION	Peak (PK)
FREQUENCY RANGE	1GHz ~ 40GHz		Average (AV)

ANTENNA POLARITY & TEST DISTANCE: HORIZONTAL AT 3 M

Rg	Frequency [MHz]	AVG Level [dBμV/m]	AVG Limit [dBμV/m]	AVG Margin [dB]	Correction [dB]	Polarization	Azimuth [deg]	Antenna Height [m]
5	5,304.000	87.61			15.11	H	138.2	1
5	5,350.000	35.73	54.00	18.27	15.18	H	138.2	1
5	5,352.500	35.68	54.00	18.32	15.18	H	280.4	1

Rg	Frequency [MHz]	PK+ Level [dBμV/m]	PK+ Limit [dBμV/m]	PK+ Margin [dB]	Correction [dB]	Polarization	Azimuth [deg]	Antenna Height [m]
5	5,304.500	97.43			15.11	H	223	2
5	5,350.000	50.52	74.00	23.48	15.18	H	359	1
5	5,353.000	50.62	74.00	23.38	15.18	H	3	2

ANTENNA POLARITY & TEST DISTANCE: VERTICAL AT 3 M

Rg	Frequency [MHz]	AVG Level [dBμV/m]	AVG Limit [dBμV/m]	AVG Margin [dB]	Correction [dB]	Polarization	Azimuth [deg]	Antenna Height [m]
5	5,303.000	87.91			15.11	V	143	1
5	5,350.000	35.82	54.00	18.18	15.18	V	5.8	1
5	5,353.000	35.75	54.00	18.25	15.18	V	5.8	1

Rg	Frequency [MHz]	PK+ Level [dBμV/m]	PK+ Limit [dBμV/m]	PK+ Margin [dB]	Correction [dB]	Polarization	Azimuth [deg]	Antenna Height [m]
5	5,301.500	96.30			15.11	V	219.4	2
5	5,350.000	49.70	74.00	24.30	15.18	V	90.5	1
5	5,363.500	50.73	74.00	23.27	15.18	V	335.4	1

REMARKS:

- Emission Level = Read Level+ Antenna Factor + Cable Loss- Preamp Factor
Margin value = Limit value – Emission Level.
- 5300MHz: Fundamental frequency.



CHANNEL	TX Channel 64	DETECTOR FUNCTION	Peak (PK)
FREQUENCY RANGE	1GHz ~ 40GHz		Average (AV)

ANTENNA POLARITY & TEST DISTANCE: HORIZONTAL AT 3 M

Rg	Frequency [MHz]	AVG Level [dBμV/m]	AVG Limit [dBμV/m]	AVG Margin [dB]	Correction [dB]	Polarization	Azimuth [deg]	Antenna Height [m]
6	5,319.000	88.29			15.11	H	141.8	1
6	5,350.000	35.72	54.00	18.28	15.18	H	141.8	1
6	5,351.500	35.69	54.00	18.31	15.18	H	141.8	1

Rg	Frequency [MHz]	PK+ Level [dBμV/m]	PK+ Limit [dBμV/m]	PK+ Margin [dB]	Correction [dB]	Polarization	Azimuth [deg]	Antenna Height [m]
6	5,325.500	97.55			15.12	H	221.8	2
6	5,350.000	49.64	74.00	24.36	15.18	H	126.2	2
6	5,378.500	51.02	74.00	22.98	15.19	H	359	1

ANTENNA POLARITY & TEST DISTANCE: VERTICAL AT 3 M

Rg	Frequency [MHz]	AVG Level [dBμV/m]	AVG Limit [dBμV/m]	AVG Margin [dB]	Correction [dB]	Polarization	Azimuth [deg]	Antenna Height [m]
6	5,321.500	89.39			15.11	V	139.4	1
6	5,350.000	35.71	54.00	18.29	15.18	V	1	1
6	5,353.500	35.67	54.00	18.33	15.18	V	187.2	1

Rg	Frequency [MHz]	PK+ Level [dBμV/m]	PK+ Limit [dBμV/m]	PK+ Margin [dB]	Correction [dB]	Polarization	Azimuth [deg]	Antenna Height [m]
6	5,320.500	100.68			15.11	V	138.2	1
6	5,350.000	49.58	74.00	24.42	15.18	V	28.2	2
6	5,366.000	50.82	74.00	23.18	15.18	V	43.8	1

REMARKS:

- Emission Level = Read Level+ Antenna Factor + Cable Loss- Preamp Factor
Margin value = Limit value – Emission Level.
- 5320MHz: Fundamental frequency.



802.11n (20MHz)

CHANNEL	TX Channel 52	DETECTOR FUNCTION	Peak (PK)
FREQUENCY RANGE	1GHz ~ 40GHz		Average (AV)

ANTENNA POLARITY & TEST DISTANCE: HORIZONTAL AT 3 M

Rg	Frequency [MHz]	AVG Level [dBμV/m]	AVG Limit [dBμV/m]	AVG Margin [dB]	Correction [dB]	Polarization	Azimuth [deg]	Antenna Height [m]
4	5,258.500	86.42			15.12	H	184.8	2
4	5,350.000	35.74	54.00	18.26	15.18	H	115.4	1
4	5,389.500	36.01	54.00	17.99	15.20	H	55.7	1

Rg	Frequency [MHz]	PK+ Level [dBμV/m]	PK+ Limit [dBμV/m]	PK+ Margin [dB]	Correction [dB]	Polarization	Azimuth [deg]	Antenna Height [m]
4	5,257.500	99.69			15.12	H	139.4	1
4	5,350.000	48.96	74.00	25.04	15.18	H	30.7	2
4	5,377.000	51.09	74.00	22.91	15.19	H	220.7	2

ANTENNA POLARITY & TEST DISTANCE: VERTICAL AT 3 M

Rg	Frequency [MHz]	AVG Level [dBμV/m]	AVG Limit [dBμV/m]	AVG Margin [dB]	Correction [dB]	Polarization	Azimuth [deg]	Antenna Height [m]
4	5,257.000	88.95			15.12	V	244.6	1
4	5,350.000	35.78	54.00	18.22	15.18	V	359	2
4	5,389.500	36.05	54.00	17.95	15.20	V	115.4	2

Rg	Frequency [MHz]	PK+ Level [dBμV/m]	PK+ Limit [dBμV/m]	PK+ Margin [dB]	Correction [dB]	Polarization	Azimuth [deg]	Antenna Height [m]
4	5,263.000	98.52			15.11	V	174.1	1
4	5,350.000	49.70	74.00	24.30	15.18	V	5.1	2
4	5,382.000	50.80	74.00	23.20	15.19	V	268.4	1

REMARKS:

- Emission Level = Read Level+ Antenna Factor + Cable Loss- Preamp Factor
Margin value = Limit value – Emission Level.
- 5260MHz: Fundamental frequency.



CHANNEL	TX Channel 60	DETECTOR FUNCTION	Peak (PK)
FREQUENCY RANGE	1GHz ~ 40GHz		Average (AV)

ANTENNA POLARITY & TEST DISTANCE: HORIZONTAL AT 3 M

Rg	Frequency [MHz]	AVG Level [dBμV/m]	AVG Limit [dBμV/m]	AVG Margin [dB]	Correction [dB]	Polarization	Azimuth [deg]	Antenna Height [m]
5	5,298.000	87.47			15.11	H	139.4	1
5	5,350.000	35.73	54.00	18.27	15.18	H	188.4	1
5	5,366.000	35.86	54.00	18.14	15.18	H	1	1

Rg	Frequency [MHz]	PK+ Level [dBμV/m]	PK+ Limit [dBμV/m]	PK+ Margin [dB]	Correction [dB]	Polarization	Azimuth [deg]	Antenna Height [m]
5	5,299.000	99.12			15.11	H	138.2	1
5	5,350.000	49.62	74.00	24.38	15.18	H	123.8	2
5	5,367.000	51.12	74.00	22.88	15.18	H	5.1	1

ANTENNA POLARITY & TEST DISTANCE: VERTICAL AT 3 M

Rg	Frequency [MHz]	AVG Level [dBμV/m]	AVG Limit [dBμV/m]	AVG Margin [dB]	Correction [dB]	Polarization	Azimuth [deg]	Antenna Height [m]
5	5,307.500	86.46			15.11	V	186	2
5	5,350.000	35.82	54.00	18.18	15.18	V	74.9	1
5	5,369.000	35.92	54.00	18.08	15.18	V	125	1

Rg	Frequency [MHz]	PK+ Level [dBμV/m]	PK+ Limit [dBμV/m]	PK+ Margin [dB]	Correction [dB]	Polarization	Azimuth [deg]	Antenna Height [m]
5	5,297.000	98.93			15.11	V	174.2	1
5	5,350.000	50.05	74.00	23.95	15.18	V	283.9	2
5	5,361.000	50.72	74.00	23.28	15.18	V	359.1	2

REMARKS:

- Emission Level = Read Level+ Antenna Factor + Cable Loss- Preamp Factor
Margin value = Limit value – Emission Level.
- 5300MHz: Fundamental frequency.



CHANNEL	TX Channel 64	DETECTOR FUNCTION	Peak (PK)
FREQUENCY RANGE	1GHz ~ 40GHz		Average (AV)

ANTENNA POLARITY & TEST DISTANCE: HORIZONTAL AT 3 M

Rg	Frequency [MHz]	AVG Level [dBμV/m]	AVG Limit [dBμV/m]	AVG Margin [dB]	Correction [dB]	Polarization	Azimuth [deg]	Antenna Height [m]
6	5,328.000	86.77			15.13	H	139.4	1
6	5,350.000	35.75	54.00	18.25	15.18	H	139.4	1
6	5,388.500	35.93	54.00	18.07	15.20	H	236.3	1

Rg	Frequency [MHz]	PK+ Level [dBμV/m]	PK+ Limit [dBμV/m]	PK+ Margin [dB]	Correction [dB]	Polarization	Azimuth [deg]	Antenna Height [m]
6	5,327.500	98.61			15.13	H	140.6	1
6	5,350.000	50.23	74.00	23.77	15.18	H	92.8	1
6	5,381.500	51.33	74.00	22.67	15.19	H	77.1	2

ANTENNA POLARITY & TEST DISTANCE: VERTICAL AT 3 M

Rg	Frequency [MHz]	AVG Level [dBμV/m]	AVG Limit [dBμV/m]	AVG Margin [dB]	Correction [dB]	Polarization	Azimuth [deg]	Antenna Height [m]
6	5,323.500	88.93			15.12	V	56.8	1
6	5,350.000	35.76	54.00	18.24	15.18	V	188.3	2
6	5,367.000	36.01	54.00	17.99	15.18	V	138.2	2

Rg	Frequency [MHz]	PK+ Level [dBμV/m]	PK+ Limit [dBμV/m]	PK+ Margin [dB]	Correction [dB]	Polarization	Azimuth [deg]	Antenna Height [m]
6	5,322.000	100.13			15.11	V	223.1	1
6	5,350.000	49.14	74.00	24.86	15.18	V	357.8	2
6	5,389.000	51.97	74.00	22.03	15.20	V	223.1	1

REMARKS:

- Emission Level = Read Level+ Antenna Factor + Cable Loss- Preamp Factor
Margin value = Limit value – Emission Level.
- 5320MHz: Fundamental frequency.



802.11n (40MHz)

CHANNEL	TX Channel 54	DETECTOR FUNCTION	Peak (PK)
FREQUENCY RANGE	1GHz ~ 40GHz		Average (AV)

ANTENNA POLARITY & TEST DISTANCE: HORIZONTAL AT 3 M

Rg	Frequency [MHz]	AVG Level [dBμV/m]	AVG Limit [dBμV/m]	AVG Margin [dB]	Correction [dB]	Polarization	Azimuth [deg]	Antenna Height [m]
3	5,271.500	88.75			12.99	H	5	1
3	5,350.000	37.96	54.00	16.04	13.20	H	5	1
3	5,408.500	38.38	54.00	15.62	13.24	H	5	1

Rg	Frequency [MHz]	PK+ Level [dBμV/m]	PK+ Limit [dBμV/m]	PK+ Margin [dB]	Correction [dB]	Polarization	Azimuth [deg]	Antenna Height [m]
3	5,261.500	100.36			12.96	H	316.1	1
3	5,350.000	51.12	74.00	22.88	13.20	H	151.5	2
3	5,423.000	53.25	74.00	20.75	13.27	H	4.3	1

ANTENNA POLARITY & TEST DISTANCE: VERTICAL AT 3 M

Rg	Frequency [MHz]	AVG Level [dBμV/m]	AVG Limit [dBμV/m]	AVG Margin [dB]	Correction [dB]	Polarization	Azimuth [deg]	Antenna Height [m]
3	5,274.000	90.88			12.99	V	355	2
3	5,350.000	37.94	54.00	16.06	13.20	V	5.6	1
3	5,407.500	38.26	54.00	15.74	13.23	V	325.6	1

Rg	Frequency [MHz]	PK+ Level [dBμV/m]	PK+ Limit [dBμV/m]	PK+ Margin [dB]	Correction [dB]	Polarization	Azimuth [deg]	Antenna Height [m]
3	5,268.000	101.79			12.98	V	41.4	2
3	5,350.000	51.36	74.00	22.64	13.20	V	257.8	2
3	5,354.500	53.01	74.00	20.99	13.20	V	359.1	1

REMARKS:

1. Emission Level = Read Level+ Antenna Factor + Cable Loss- Preamp Factor
Margin value = Limit value – Emission Level.
2. 5270MHz: Fundamental frequency.



CHANNEL	TX Channel 62	DETECTOR FUNCTION	Peak (PK)
FREQUENCY RANGE	1GHz ~ 40GHz		Average (AV)

ANTENNA POLARITY & TEST DISTANCE: HORIZONTAL AT 3 M

Rg	Frequency [MHz]	AVG Level [dBμV/m]	AVG Limit [dBμV/m]	AVG Margin [dB]	Correction [dB]	Polarization	Azimuth [deg]	Antenna Height [m]
4	5,322.500	89.97			13.14	H	355	2
4	5,350.000	39.88	54.00	14.12	13.20	H	214.5	1
4	5,354.000	38.92	54.00	15.08	13.20	H	5.6	1

Rg	Frequency [MHz]	PK+ Level [dBμV/m]	PK+ Limit [dBμV/m]	PK+ Margin [dB]	Correction [dB]	Polarization	Azimuth [deg]	Antenna Height [m]
4	5,322.500	100.04			13.14	H	355	2
4	5,350.000	52.83	74.00	21.17	13.20	H	355	2
4	5,354.500	53.20	74.00	20.80	13.20	H	5	1

ANTENNA POLARITY & TEST DISTANCE: VERTICAL AT 3 M

Rg	Frequency [MHz]	AVG Level [dBμV/m]	AVG Limit [dBμV/m]	AVG Margin [dB]	Correction [dB]	Polarization	Azimuth [deg]	Antenna Height [m]
4	5,314.000	90.12			13.12	V	355.6	2
4	5,350.000	42.79	54.00	11.21	13.20	V	109.3	1
4	5,351.500	42.02	54.00	11.98	13.20	V	109.3	1

Rg	Frequency [MHz]	PK+ Level [dBμV/m]	PK+ Limit [dBμV/m]	PK+ Margin [dB]	Correction [dB]	Polarization	Azimuth [deg]	Antenna Height [m]
4	5,298.500	101.12			13.07	V	42.6	2
4	5,350.000	54.32	74.00	19.68	13.20	V	330.5	1
4	5,350.500	55.33	74.00	18.67	13.20	V	107	1

REMARKS:

- Emission Level = Read Level+ Antenna Factor + Cable Loss- Preamp Factor
Margin value = Limit value – Emission Level.
- 5310MHz: Fundamental frequency.



802.11ac (20MHz)

CHANNEL	TX Channel 52	DETECTOR FUNCTION	Peak (PK)
FREQUENCY RANGE	1GHz ~ 40GHz		Average (AV)

ANTENNA POLARITY & TEST DISTANCE: HORIZONTAL AT 3 M

Rg	Frequency [MHz]	AVG Level [dBμV/m]	AVG Limit [dBμV/m]	AVG Margin [dB]	Correction [dB]	Polarization	Azimuth [deg]	Antenna Height [m]
4	5,258.000	83.19			15.12	H	182.4	2
4	5,350.000	35.80	54.00	18.20	15.18	H	303.2	2
4	5,389.000	36.08	54.00	17.92	15.20	H	114.3	1

Rg	Frequency [MHz]	PK+ Level [dBμV/m]	PK+ Limit [dBμV/m]	PK+ Margin [dB]	Correction [dB]	Polarization	Azimuth [deg]	Antenna Height [m]
4	5,257.500	97.91			15.12	H	139.4	1
4	5,350.000	50.10	74.00	23.90	15.18	H	359	1
4	5,375.500	51.09	74.00	22.91	15.19	H	5.2	1

ANTENNA POLARITY & TEST DISTANCE: VERTICAL AT 3 M

Rg	Frequency [MHz]	AVG Level [dBμV/m]	AVG Limit [dBμV/m]	AVG Margin [dB]	Correction [dB]	Polarization	Azimuth [deg]	Antenna Height [m]
4	5,256.000	88.52			15.13	V	176.6	2
4	5,350.000	35.85	54.00	18.15	15.18	V	237.5	2
4	5,388.500	36.08	54.00	17.92	15.20	V	242.2	1

Rg	Frequency [MHz]	PK+ Level [dBμV/m]	PK+ Limit [dBμV/m]	PK+ Margin [dB]	Correction [dB]	Polarization	Azimuth [deg]	Antenna Height [m]
4	5,257.500	99.36			15.12	V	188.4	2
4	5,350.000	49.80	74.00	24.20	15.18	V	316.2	1
4	5,366.000	50.39	74.00	23.61	15.18	V	1	1

REMARKS:

- Emission Level = Read Level+ Antenna Factor + Cable Loss- Preamp Factor
Margin value = Limit value – Emission Level.
- 5260MHz: Fundamental frequency.



CHANNEL	TX Channel 60	DETECTOR FUNCTION	Peak (PK)
FREQUENCY RANGE	1GHz ~ 40GHz		Average (AV)

ANTENNA POLARITY & TEST DISTANCE: HORIZONTAL AT 3 M

Rg	Frequency [MHz]	AVG Level [dBμV/m]	AVG Limit [dBμV/m]	AVG Margin [dB]	Correction [dB]	Polarization	Azimuth [deg]	Antenna Height [m]
5	5,301.000	87.24			15.11	H	221.8	1
5	5,350.000	35.81	54.00	18.19	15.18	H	172.9	1
5	5,351.500	35.84	54.00	18.16	15.18	H	90.5	2

Rg	Frequency [MHz]	PK+ Level [dBμV/m]	PK+ Limit [dBμV/m]	PK+ Margin [dB]	Correction [dB]	Polarization	Azimuth [deg]	Antenna Height [m]
5	5,301.500	98.26			15.11	H	221.8	1
5	5,350.000	50.04	74.00	23.96	15.18	H	138.2	2
5	5,363.000	51.70	74.00	22.30	15.18	H	128.6	1

ANTENNA POLARITY & TEST DISTANCE: VERTICAL AT 3 M

Rg	Frequency [MHz]	AVG Level [dBμV/m]	AVG Limit [dBμV/m]	AVG Margin [dB]	Correction [dB]	Polarization	Azimuth [deg]	Antenna Height [m]
5	5,296.000	87.38			15.11	V	221.8	1
5	5,350.000	35.75	54.00	18.25	15.18	V	77.2	1
5	5,352.500	35.76	54.00	18.24	15.18	V	355.6	1

Rg	Frequency [MHz]	PK+ Level [dBμV/m]	PK+ Limit [dBμV/m]	PK+ Margin [dB]	Correction [dB]	Polarization	Azimuth [deg]	Antenna Height [m]
5	5,306.000	99.43			15.11	V	139.4	2
5	5,350.000	50.09	74.00	23.91	15.18	V	317.4	1
5	5,361.500	50.92	74.00	23.08	15.18	V	221.8	1

REMARKS:

- Emission Level = Read Level+ Antenna Factor + Cable Loss- Preamp Factor
Margin value = Limit value – Emission Level.
- 5300MHz: Fundamental frequency.



CHANNEL	TX Channel 64	DETECTOR FUNCTION	Peak (PK)
FREQUENCY RANGE	1GHz ~ 40GHz		Average (AV)

ANTENNA POLARITY & TEST DISTANCE: HORIZONTAL AT 3 M

Rg	Frequency [MHz]	AVG Level [dBμV/m]	AVG Limit [dBμV/m]	AVG Margin [dB]	Correction [dB]	Polarization	Azimuth [deg]	Antenna Height [m]
6	5,327.500	86.99			15.13	H	138.2	2
6	5,350.000	35.87	54.00	18.13	15.18	H	138.2	2
6	5,365.500	35.94	54.00	18.06	15.18	H	220.6	1

Rg	Frequency [MHz]	PK+ Level [dBμV/m]	PK+ Limit [dBμV/m]	PK+ Margin [dB]	Correction [dB]	Polarization	Azimuth [deg]	Antenna Height [m]
6	5,316.500	98.87			15.11	H	171.8	1
6	5,350.000	49.57	74.00	24.43	15.18	H	220.6	1
6	5,359.000	51.82	74.00	22.18	15.18	H	268.5	1

ANTENNA POLARITY & TEST DISTANCE: VERTICAL AT 3 M

Rg	Frequency [MHz]	AVG Level [dBμV/m]	AVG Limit [dBμV/m]	AVG Margin [dB]	Correction [dB]	Polarization	Azimuth [deg]	Antenna Height [m]
6	5,316.000	87.70			15.11	V	221.8	1
6	5,350.000	35.77	54.00	18.23	15.18	V	221.8	1
6	5,352.000	35.77	54.00	18.23	15.18	V	221.8	1

Rg	Frequency [MHz]	PK+ Level [dBμV/m]	PK+ Limit [dBμV/m]	PK+ Margin [dB]	Correction [dB]	Polarization	Azimuth [deg]	Antenna Height [m]
6	5,315.500	100.60			15.11	V	219.4	1
6	5,350.000	49.70	74.00	24.30	15.18	V	2.5	1
6	5,365.000	50.73	74.00	23.27	15.18	V	354.9	1

REMARKS:

- Emission Level = Read Level+ Antenna Factor + Cable Loss- Preamp Factor
Margin value = Limit value – Emission Level.
- 5320MHz: Fundamental frequency.



802.11ac (40MHz)

CHANNEL	TX Channel 54	DETECTOR FUNCTION	Peak (PK)
FREQUENCY RANGE	1GHz ~ 40GHz		Average (AV)

ANTENNA POLARITY & TEST DISTANCE: HORIZONTAL AT 3 M

Rg	Frequency [MHz]	AVG Level [dBμV/m]	AVG Limit [dBμV/m]	AVG Margin [dB]	Correction [dB]	Polarization	Azimuth [deg]	Antenna Height [m]
3	5,277.500	85.68			15.10	H	141.8	1
3	5,350.000	35.69	54.00	18.31	15.18	H	218.2	2
3	5,423.000	36.38	54.00	17.62	15.29	H	218.2	2

Rg	Frequency [MHz]	PK+ Level [dBμV/m]	PK+ Limit [dBμV/m]	PK+ Margin [dB]	Correction [dB]	Polarization	Azimuth [deg]	Antenna Height [m]
3	5,277.500	97.69			15.10	H	140.6	1
3	5,350.000	49.40	74.00	24.60	15.18	H	140.6	1
3	5,443.500	51.34	74.00	22.66	15.30	H	92.8	1

ANTENNA POLARITY & TEST DISTANCE: VERTICAL AT 3 M

Rg	Frequency [MHz]	AVG Level [dBμV/m]	AVG Limit [dBμV/m]	AVG Margin [dB]	Correction [dB]	Polarization	Azimuth [deg]	Antenna Height [m]
3	5,273.000	85.95			15.10	V	140.6	1
3	5,350.000	35.72	54.00	18.28	15.18	V	189.6	1
3	5,429.500	36.27	54.00	17.73	15.30	V	140.6	1

Rg	Frequency [MHz]	PK+ Level [dBμV/m]	PK+ Limit [dBμV/m]	PK+ Margin [dB]	Correction [dB]	Polarization	Azimuth [deg]	Antenna Height [m]
3	5,272.000	98.41			15.10	V	141.8	1
3	5,350.000	49.87	74.00	24.13	15.18	V	141.8	1
3	5,399.000	50.96	74.00	23.04	15.21	V	92.8	1

REMARKS:

- Emission Level = Read Level+ Antenna Factor + Cable Loss- Preamp Factor
Margin value = Limit value – Emission Level.
- 5270MHz: Fundamental frequency.



CHANNEL	TX Channel 62	DETECTOR FUNCTION	Peak (PK)
FREQUENCY RANGE	1GHz ~ 40GHz		Average (AV)

ANTENNA POLARITY & TEST DISTANCE: HORIZONTAL AT 3 M

Rg	Frequency [MHz]	AVG Level [dBμV/m]	AVG Limit [dBμV/m]	AVG Margin [dB]	Correction [dB]	Polarization	Azimuth [deg]	Antenna Height [m]
4	5,307.500	85.95			15.11	H	140.6	1
4	5,350.000	38.98	54.00	15.02	15.18	H	215.8	2
4	5,350.500	38.66	54.00	15.34	15.18	H	215.8	2

Rg	Frequency [MHz]	PK+ Level [dBμV/m]	PK+ Limit [dBμV/m]	PK+ Margin [dB]	Correction [dB]	Polarization	Azimuth [deg]	Antenna Height [m]
4	5,308.000	97.02			15.11	H	141.8	1
4	5,350.000	51.34	74.00	22.66	15.18	H	141.8	1
4	5,353.000	53.22	74.00	20.78	15.18	H	141.8	1

ANTENNA POLARITY & TEST DISTANCE: VERTICAL AT 3 M

Rg	Frequency [MHz]	AVG Level [dBμV/m]	AVG Limit [dBμV/m]	AVG Margin [dB]	Correction [dB]	Polarization	Azimuth [deg]	Antenna Height [m]
4	5,303.000	85.10			15.11	V	139.4	1
4	5,350.000	36.32	54.00	17.68	15.18	V	218.2	2
4	5,353.500	36.75	54.00	17.25	15.18	V	5.2	1

Rg	Frequency [MHz]	PK+ Level [dBμV/m]	PK+ Limit [dBμV/m]	PK+ Margin [dB]	Correction [dB]	Polarization	Azimuth [deg]	Antenna Height [m]
4	5,304.500	96.96			15.11	V	139.4	1
4	5,350.000	50.75	74.00	23.25	15.18	V	218.2	2
4	5,353.500	51.69	74.00	22.31	15.18	V	4.5	1

REMARKS:

- Emission Level = Read Level+ Antenna Factor + Cable Loss- Preamp Factor
Margin value = Limit value – Emission Level.
- 5310MHz: Fundamental frequency.



802.11ac (80MHz)

CHANNEL	TX Channel 58	DETECTOR FUNCTION	Peak (PK)
FREQUENCY RANGE	1GHz ~ 40GHz		Average (AV)

ANTENNA POLARITY & TEST DISTANCE: HORIZONTAL AT 3 M

Rg	Frequency [MHz]	AVG Level [dBμV/m]	AVG Limit [dBμV/m]	AVG Margin [dB]	Correction [dB]	Polarization	Azimuth [deg]	Antenna Height [m]
2	5,253.200	84.51			12.95	H	4.9	1
2	5,350.000	38.20	54.00	15.80	13.20	H	359	1
2	5,366.867	40.80	54.00	13.20	13.20	H	4.9	1

Rg	Frequency [MHz]	PK+ Level [dBμV/m]	PK+ Limit [dBμV/m]	PK+ Margin [dB]	Correction [dB]	Polarization	Azimuth [deg]	Antenna Height [m]
2	5,273.000	99.92			12.99	H	312.5	1
2	5,350.000	54.21	74.00	19.79	13.20	H	4.3	1
2	5,359.900	54.17	74.00	19.83	13.20	H	4.3	1

ANTENNA POLARITY & TEST DISTANCE: VERTICAL AT 3 M

Rg	Frequency [MHz]	AVG Level [dBμV/m]	AVG Limit [dBμV/m]	AVG Margin [dB]	Correction [dB]	Polarization	Azimuth [deg]	Antenna Height [m]
2	5,310.033	87.18			13.11	V	5	1
2	5,350.000	41.72	54.00	12.28	13.20	V	359	2
2	5,355.867	42.06	54.00	11.94	13.20	V	359.1	1

Rg	Frequency [MHz]	PK+ Level [dBμV/m]	PK+ Limit [dBμV/m]	PK+ Margin [dB]	Correction [dB]	Polarization	Azimuth [deg]	Antenna Height [m]
2	5,288.770	100.29			13.04	V	45	2
2	5,350.000	54.18	74.00	19.82	13.20	V	0.9	2
2	5,352.933	57.09	74.00	16.91	13.20	V	359	1

REMARKS:

- Emission Level = Read Level+ Antenna Factor + Cable Loss- Preamp Factor
Margin value = Limit value – Emission Level.
- 5290MHz: Fundamental frequency.



802.11ax (20MHz)

CHANNEL	TX Channel 52	DETECTOR FUNCTION	Peak (PK)
FREQUENCY RANGE	1GHz ~ 40GHz		Average (AV)

ANTENNA POLARITY & TEST DISTANCE: HORIZONTAL AT 3 M

Rg	Frequency [MHz]	AVG Level [dBμV/m]	AVG Limit [dBμV/m]	AVG Margin [dB]	Correction [dB]	Polarization	Azimuth [deg]	Antenna Height [m]
4	5,256.000	83.22			12.95	H	4.2	1
4	5,350.000	35.84	54.00	18.16	13.20	H	4.2	1
4	5,370.000	36.13	54.00	17.87	13.20	H	4.2	1

Rg	Frequency [MHz]	PK+ Level [dBμV/m]	PK+ Limit [dBμV/m]	PK+ Margin [dB]	Correction [dB]	Polarization	Azimuth [deg]	Antenna Height [m]
4	5,261.500	104.42			12.96	H	4.9	1
4	5,350.000	49.30	74.00	24.70	13.20	H	90.5	2
4	5,378.000	51.39	74.00	22.61	13.20	H	145.5	2

ANTENNA POLARITY & TEST DISTANCE: VERTICAL AT 3 M

Rg	Frequency [MHz]	AVG Level [dBμV/m]	AVG Limit [dBμV/m]	AVG Margin [dB]	Correction [dB]	Polarization	Azimuth [deg]	Antenna Height [m]
4	5,254.000	90.66			12.95	V	359	2
4	5,350.000	36.69	54.00	17.31	13.20	V	359	1
4	5,370.000	37.03	54.00	16.97	13.20	V	359	1

Rg	Frequency [MHz]	PK+ Level [dBμV/m]	PK+ Limit [dBμV/m]	PK+ Margin [dB]	Correction [dB]	Polarization	Azimuth [deg]	Antenna Height [m]
4	5,254.500	107.96			12.95	V	355	2
4	5,350.000	50.24	74.00	23.76	13.20	V	144.3	2
4	5,380.000	51.61	74.00	22.39	13.20	V	0.9	2

REMARKS:

- Emission Level = Read Level+ Antenna Factor + Cable Loss- Preamp Factor
Margin value = Limit value – Emission Level.
- 5260MHz: Fundamental frequency.



CHANNEL	TX Channel 60	DETECTOR FUNCTION	Peak (PK)
FREQUENCY RANGE	1GHz ~ 40GHz		Average (AV)

ANTENNA POLARITY & TEST DISTANCE: HORIZONTAL AT 3 M

Rg	Frequency [MHz]	AVG Level [dBμV/m]	AVG Limit [dBμV/m]	AVG Margin [dB]	Correction [dB]	Polarization	Azimuth [deg]	Antenna Height [m]
6	5,291.000	91.31			13.05	H	270.6	1
6	5,350.000	35.95	54.00	18.05	13.20	H	355	2
6	5,354.000	36.02	54.00	17.98	13.20	H	355	2

Rg	Frequency [MHz]	PK+ Level [dBμV/m]	PK+ Limit [dBμV/m]	PK+ Margin [dB]	Correction [dB]	Polarization	Azimuth [deg]	Antenna Height [m]
6	5,302.000	105.24			13.08	H	5	1
6	5,350.000	49.81	74.00	24.19	13.20	H	309.2	2
6	5,368.500	51.02	74.00	22.98	13.20	H	275.4	1

ANTENNA POLARITY & TEST DISTANCE: VERTICAL AT 3 M

Rg	Frequency [MHz]	AVG Level [dBμV/m]	AVG Limit [dBμV/m]	AVG Margin [dB]	Correction [dB]	Polarization	Azimuth [deg]	Antenna Height [m]
6	5,305.500	91.54			13.09	V	91.7	2
6	5,350.000	36.11	54.00	17.89	13.20	V	359.1	1
6	5,357.000	36.34	54.00	17.66	13.20	V	270.7	1

Rg	Frequency [MHz]	PK+ Level [dBμV/m]	PK+ Limit [dBμV/m]	PK+ Margin [dB]	Correction [dB]	Polarization	Azimuth [deg]	Antenna Height [m]
6	5,301.500	106.56			13.08	V	65.4	2
6	5,350.000	50.49	74.00	23.51	13.20	V	357.8	1
6	5,360.000	51.13	74.00	22.87	13.20	V	277.8	1

REMARKS:

- Emission Level = Read Level+ Antenna Factor + Cable Loss- Preamp Factor
Margin value = Limit value – Emission Level.
- 5300MHz: Fundamental frequency.



CHANNEL	TX Channel 64	DETECTOR FUNCTION	Peak (PK)
FREQUENCY RANGE	1GHz ~ 40GHz		Average (AV)

ANTENNA POLARITY & TEST DISTANCE: HORIZONTAL AT 3 M

Rg	Frequency [MHz]	AVG Level [dBμV/m]	AVG Limit [dBμV/m]	AVG Margin [dB]	Correction [dB]	Polarization	Azimuth [deg]	Antenna Height [m]
7	5,323.000	95.62			13.14	H	299.4	1
7	5,350.000	39.37	54.00	14.63	13.20	H	299.4	1
7	5,370.000	39.59	54.00	14.41	13.20	H	355	2

Rg	Frequency [MHz]	PK+ Level [dBμV/m]	PK+ Limit [dBμV/m]	PK+ Margin [dB]	Correction [dB]	Polarization	Azimuth [deg]	Antenna Height [m]
7	5,321.500	106.16			13.14	H	5	1
7	5,350.000	51.83	74.00	22.17	13.20	H	0.9	2
7	5,372.500	53.55	74.00	20.45	13.20	H	359	1

ANTENNA POLARITY & TEST DISTANCE: VERTICAL AT 3 M

Rg	Frequency [MHz]	AVG Level [dBμV/m]	AVG Limit [dBμV/m]	AVG Margin [dB]	Correction [dB]	Polarization	Azimuth [deg]	Antenna Height [m]
7	5,315.500	94.24			13.12	V	28.4	2
7	5,350.000	39.56	54.00	14.44	13.20	V	359.1	1
7	5,375.000	39.67	54.00	14.33	13.20	V	352.2	1

Rg	Frequency [MHz]	PK+ Level [dBμV/m]	PK+ Limit [dBμV/m]	PK+ Margin [dB]	Correction [dB]	Polarization	Azimuth [deg]	Antenna Height [m]
7	5,317.000	106.73			13.13	V	29.5	2
7	5,350.000	52.01	74.00	21.99	13.20	V	2.2	2
7	5,399.500	53.29	74.00	20.71	13.21	V	244.3	1

REMARKS:

1. Emission Level = Read Level+ Antenna Factor + Cable Loss- Preamp Factor
Margin value = Limit value – Emission Level.
2. 5320MHz: Fundamental frequency.



802.11ax (40MHz)

CHANNEL	TX Channel 54	DETECTOR FUNCTION	Peak (PK)
FREQUENCY RANGE	1GHz ~ 40GHz		Average (AV)

ANTENNA POLARITY & TEST DISTANCE: HORIZONTAL AT 3 M

Rg	Frequency [MHz]	AVG Level [dBμV/m]	AVG Limit [dBμV/m]	AVG Margin [dB]	Correction [dB]	Polarization	Azimuth [deg]	Antenna Height [m]
3	5,254.000	87.03			12.95	H	355.6	2
3	5,350.000	37.86	54.00	16.14	13.20	H	5	1
3	5,369.500	38.19	54.00	15.81	13.20	H	5	1

Rg	Frequency [MHz]	PK+ Level [dBμV/m]	PK+ Limit [dBμV/m]	PK+ Margin [dB]	Correction [dB]	Polarization	Azimuth [deg]	Antenna Height [m]
3	5,269.000	101.05			12.98	H	335.2	1
3	5,350.000	51.31	74.00	22.69	13.20	H	355	2
3	5,408.000	53.86	74.00	20.14	13.23	H	224.1	1

ANTENNA POLARITY & TEST DISTANCE: VERTICAL AT 3 M

Rg	Frequency [MHz]	AVG Level [dBμV/m]	AVG Limit [dBμV/m]	AVG Margin [dB]	Correction [dB]	Polarization	Azimuth [deg]	Antenna Height [m]
3	5,274.000	87.15			12.99	V	0.9	2
3	5,350.000	38.00	54.00	16.00	13.20	V	359.1	1
3	5,380.500	38.27	54.00	15.73	13.20	V	359.1	1

Rg	Frequency [MHz]	PK+ Level [dBμV/m]	PK+ Limit [dBμV/m]	PK+ Margin [dB]	Correction [dB]	Polarization	Azimuth [deg]	Antenna Height [m]
3	5,268.000	105.11			12.98	V	45	2
3	5,350.000	51.75	74.00	22.25	13.20	V	334.1	1
3	5,449.000	53.53	74.00	20.47	13.28	V	5	1

REMARKS:

- Emission Level = Read Level+ Antenna Factor + Cable Loss- Preamp Factor
Margin value = Limit value – Emission Level.
- 5270MHz: Fundamental frequency.



CHANNEL	TX Channel 62	DETECTOR FUNCTION	Peak (PK)
FREQUENCY RANGE	1GHz ~ 40GHz		Average (AV)

ANTENNA POLARITY & TEST DISTANCE: HORIZONTAL AT 3 M

Rg	Frequency [MHz]	AVG Level [dBμV/m]	AVG Limit [dBμV/m]	AVG Margin [dB]	Correction [dB]	Polarization	Azimuth [deg]	Antenna Height [m]
4	5,304.000	90.30			13.09	H	270.6	1
4	5,350.000	38.44	54.00	15.56	13.20	H	359.1	1
4	5,360.000	38.04	54.00	15.96	13.20	H	270.6	1

Rg	Frequency [MHz]	PK+ Level [dBμV/m]	PK+ Limit [dBμV/m]	PK+ Margin [dB]	Correction [dB]	Polarization	Azimuth [deg]	Antenna Height [m]
4	5,309.000	104.47			13.10	H	14.9	1
4	5,350.000	51.92	74.00	22.08	13.20	H	1	1
4	5,380.500	53.38	74.00	20.62	13.20	H	14.9	1

ANTENNA POLARITY & TEST DISTANCE: VERTICAL AT 3 M

Rg	Frequency [MHz]	AVG Level [dBμV/m]	AVG Limit [dBμV/m]	AVG Margin [dB]	Correction [dB]	Polarization	Azimuth [deg]	Antenna Height [m]
4	5,309.000	90.45			13.10	V	90.5	2
4	5,350.000	40.86	54.00	13.14	13.20	V	359.1	1
4	5,353.500	39.38	54.00	14.62	13.20	V	0.9	2

Rg	Frequency [MHz]	PK+ Level [dBμV/m]	PK+ Limit [dBμV/m]	PK+ Margin [dB]	Correction [dB]	Polarization	Azimuth [deg]	Antenna Height [m]
4	5,298.500	103.13			13.07	V	42.7	2
4	5,350.000	55.76	74.00	18.24	13.20	V	110.5	1
4	5,350.500	56.01	74.00	17.99	13.20	V	110.5	1

REMARKS:

- Emission Level = Read Level+ Antenna Factor + Cable Loss- Preamp Factor
Margin value = Limit value – Emission Level.
- 5310MHz: Fundamental frequency.



802.11ax (80MHz)

CHANNEL	TX Channel 58	DETECTOR FUNCTION	Peak (PK)
FREQUENCY RANGE	1GHz ~ 40GHz		Average (AV)

ANTENNA POLARITY & TEST DISTANCE: HORIZONTAL AT 3 M

Rg	Frequency [MHz]	AVG Level [dBμV/m]	AVG Limit [dBμV/m]	AVG Margin [dB]	Correction [dB]	Polarization	Azimuth [deg]	Antenna Height [m]
2	5,252.467	83.03			12.94	H	5.7	1
2	5,350.000	38.09	54.00	15.91	13.20	H	359.1	1
2	5,368.700	39.33	54.00	14.67	13.20	H	5.7	1

Rg	Frequency [MHz]	PK+ Level [dBμV/m]	PK+ Limit [dBμV/m]	PK+ Margin [dB]	Correction [dB]	Polarization	Azimuth [deg]	Antenna Height [m]
2	5,257.967	98.85			12.96	H	320.9	1
2	5,350.000	51.28	74.00	22.72	13.20	H	300.8	2
2	5,442.033	53.78	74.00	20.22	13.28	H	5.7	1

ANTENNA POLARITY & TEST DISTANCE: VERTICAL AT 3 M

Rg	Frequency [MHz]	AVG Level [dBμV/m]	AVG Limit [dBμV/m]	AVG Margin [dB]	Correction [dB]	Polarization	Azimuth [deg]	Antenna Height [m]
2	5,301.967	85.99			13.08	V	14.9	1
2	5,350.000	39.60	54.00	14.40	13.20	V	1	2
2	5,367.967	39.60	54.00	14.40	13.20	V	355	2

Rg	Frequency [MHz]	PK+ Level [dBμV/m]	PK+ Limit [dBμV/m]	PK+ Margin [dB]	Correction [dB]	Polarization	Azimuth [deg]	Antenna Height [m]
2	5,265.670	101.74			12.97	V	39	2
2	5,350.000	52.94	74.00	21.06	13.20	V	359	2
2	5,367.967	54.01	74.00	19.99	13.20	V	359	1

REMARKS:

- Emission Level = Read Level+ Antenna Factor + Cable Loss- Preamp Factor
Margin value = Limit value – Emission Level.
- 5290MHz: Fundamental frequency.



802.11ac (80MHz)

Worst case harmonic:

CHANNEL	TX Channel 58	DETECTOR FUNCTION	Peak (PK)
FREQUENCY RANGE	1GHz ~ 40GHz		Average (AV)

ANTENNA POLARITY & TEST DISTANCE: HORIZONTAL AT 3 M

Rg	Frequency [MHz]	PK+ Level [dBμV/m]	PK+ Limit [dBμV/m]	PK+ Margin [dB]	AVG Level [dBμV/m]	AVG Limit [dBμV/m]	AVG Margin [dB]	Correction [dB]	Polarization	Azimuth [deg]	Antenna Height [m]
4	10,580.500	44.36	74.00	29.64	33.77	54.00	20.23	11.28	H	359.1	1
4	15,870.000	47.16	74.00	26.84	36.94	54.00	17.06	16.35	H	1.4	2

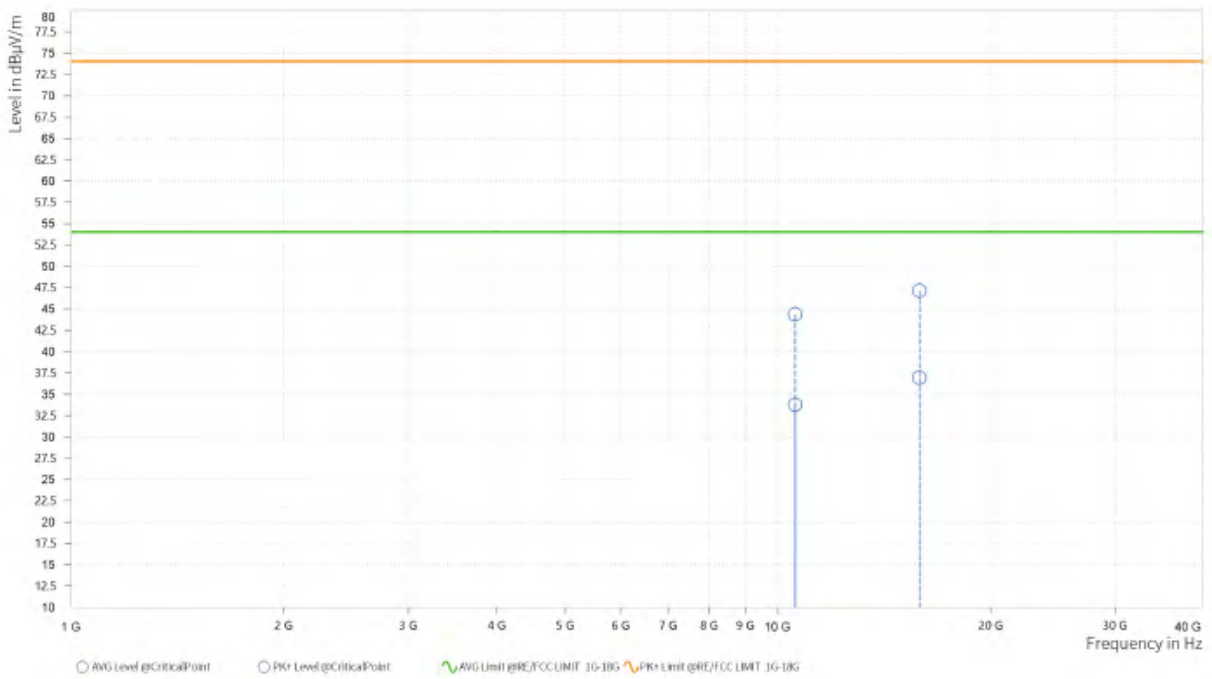



ANTENNA POLARITY & TEST DISTANCE: VERTICAL AT 3 M

Rg	Frequency [MHz]	PK+ Level [dBμV/m]	PK+ Limit [dBμV/m]	PK+ Margin [dB]	AVG Level [dBμV/m]	AVG Limit [dBμV/m]	AVG Margin [dB]	Correction [dB]	Polarization	Azimuth [deg]	Antenna Height [m]
4	10,580.000	45.35	74.00	28.65	33.94	54.00	20.06	11.28	V	1.4	2
4	15,870.000	46.36	74.00	27.64	36.36	54.00	17.64	16.35	V	1.4	2

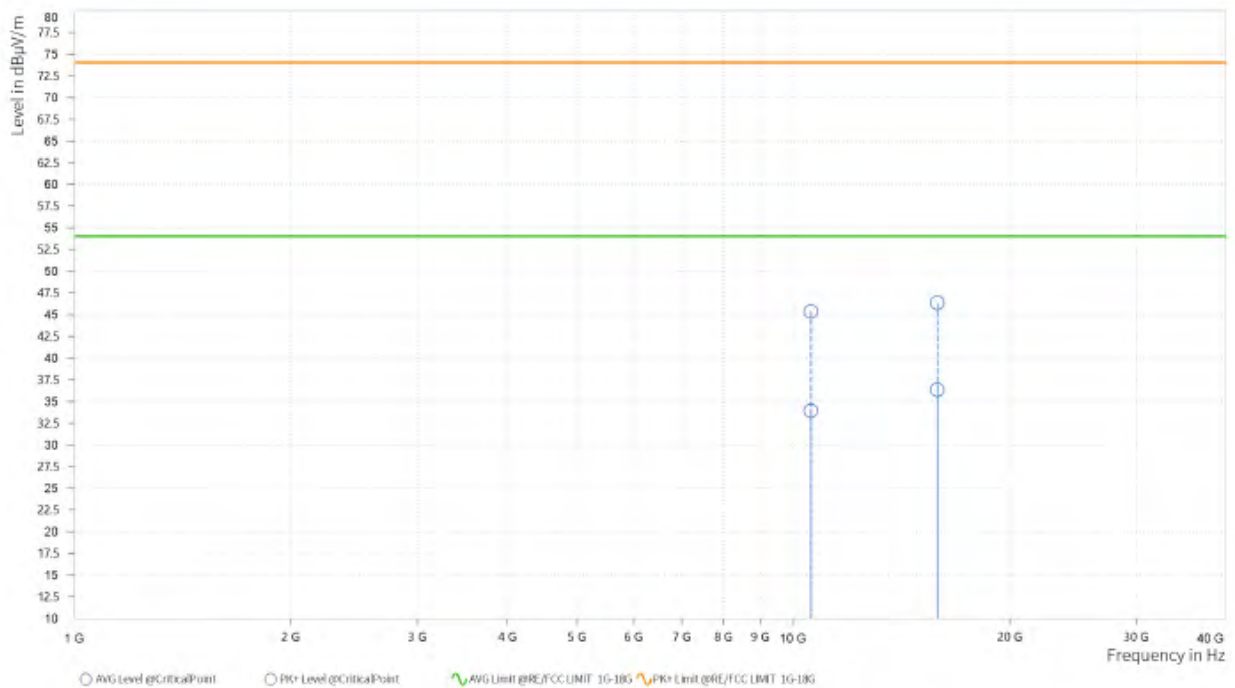

REMARKS:

1. Emission Level = Read Level+ Antenna Factor + Cable Loss- Preamp Factor
Margin value = Limit value – Emission Level.
2. 5290MHz: Fundamental frequency.



5G WIFI-RU

802.11ax (20MHz) (RU26):

CHANNEL	TX Channel 52	DETECTOR FUNCTION	Peak (PK)
FREQUENCY RANGE	1GHz ~ 40GHz		Average (AV)

ANTENNA POLARITY & TEST DISTANCE: HORIZONTAL AT 3 M

Rg	Frequency [MHz]	AVG Level [dBμV/m]	AVG Limit [dBμV/m]	AVG Margin [dB]	Correction [dB]	Polarization	Azimuth [deg]	Antenna Height [m]
4	5,251.500	86.74			15.14	H	176.5	1
4	5,350.000	35.92	54.00	18.08	15.18	H	1	1
4	5,386.000	36.15	54.00	17.85	15.20	H	116.6	1

Rg	Frequency [MHz]	PK+ Level [dBμV/m]	PK+ Limit [dBμV/m]	PK+ Margin [dB]	Correction [dB]	Polarization	Azimuth [deg]	Antenna Height [m]
4	5,251.500	102.63			15.14	H	223	2
4	5,350.000	50.27	74.00	23.73	15.18	H	269.7	2
4	5,384.000	50.93	74.00	23.07	15.20	H	281.6	1

ANTENNA POLARITY & TEST DISTANCE: VERTICAL AT 3 M

Rg	Frequency [MHz]	AVG Level [dBμV/m]	AVG Limit [dBμV/m]	AVG Margin [dB]	Correction [dB]	Polarization	Azimuth [deg]	Antenna Height [m]
4	5,251.500	83.89			15.14	V	304.4	2
4	5,350.000	35.89	54.00	18.11	15.18	V	5	1
4	5,389.000	36.13	54.00	17.87	15.20	V	115.4	1

Rg	Frequency [MHz]	PK+ Level [dBμV/m]	PK+ Limit [dBμV/m]	PK+ Margin [dB]	Correction [dB]	Polarization	Azimuth [deg]	Antenna Height [m]
4	5,251.500	96.51			15.14	V	199.1	1
4	5,350.000	49.92	74.00	24.08	15.18	V	359	2
4	5,376.500	51.05	74.00	22.95	15.19	V	356.1	2

REMARKS:

- Emission Level = Read Level+ Antenna Factor + Cable Loss- Preamp Factor
Margin value = Limit value – Emission Level.
- 5260MHz: Fundamental frequency.



CHANNEL	TX Channel 60	DETECTOR FUNCTION	Peak (PK)
FREQUENCY RANGE	1GHz ~ 40GHz		Average (AV)

ANTENNA POLARITY & TEST DISTANCE: HORIZONTAL AT 3 M

Rg	Frequency [MHz]	AVG Level [dBμV/m]	AVG Limit [dBμV/m]	AVG Margin [dB]	Correction [dB]	Polarization	Azimuth [deg]	Antenna Height [m]
5	5,300.500	89.74			15.11	H	220.6	2
5	5,350.000	35.80	54.00	18.20	15.18	H	138.2	1
5	5,367.000	35.97	54.00	18.03	15.18	H	356.8	1

Rg	Frequency [MHz]	PK+ Level [dBμV/m]	PK+ Limit [dBμV/m]	PK+ Margin [dB]	Correction [dB]	Polarization	Azimuth [deg]	Antenna Height [m]
5	5,300.500	102.42			15.11	H	220.7	2
5	5,350.000	49.53	74.00	24.47	15.18	H	357.7	1
5	5,356.500	50.72	74.00	23.28	15.18	H	0.9	2

ANTENNA POLARITY & TEST DISTANCE: VERTICAL AT 3 M

Rg	Frequency [MHz]	AVG Level [dBμV/m]	AVG Limit [dBμV/m]	AVG Margin [dB]	Correction [dB]	Polarization	Azimuth [deg]	Antenna Height [m]
5	5,300.500	81.32			15.11	V	221.9	2
5	5,350.000	35.81	54.00	18.19	15.18	V	1	1
5	5,368.500	35.99	54.00	18.01	15.18	V	220.7	1

Rg	Frequency [MHz]	PK+ Level [dBμV/m]	PK+ Limit [dBμV/m]	PK+ Margin [dB]	Correction [dB]	Polarization	Azimuth [deg]	Antenna Height [m]
5	5,300.500	99.51			15.11	V	139.4	1
5	5,350.000	50.07	74.00	23.93	15.18	V	139.4	1
5	5,357.000	50.94	74.00	23.06	15.18	V	187.2	1

REMARKS:

- Emission Level = Read Level+ Antenna Factor + Cable Loss- Preamp Factor
Margin value = Limit value – Emission Level.
- 5300MHz: Fundamental frequency.



CHANNEL	TX Channel 64	DETECTOR FUNCTION	Peak (PK)
FREQUENCY RANGE	1GHz ~ 40GHz		Average (AV)

ANTENNA POLARITY & TEST DISTANCE: HORIZONTAL AT 3 M

Rg	Frequency [MHz]	AVG Level [dBμV/m]	AVG Limit [dBμV/m]	AVG Margin [dB]	Correction [dB]	Polarization	Azimuth [deg]	Antenna Height [m]
6	5,328.500	90.31			15.13	H	220.6	2
6	5,350.000	35.84	54.00	18.16	15.18	H	1	1
6	5,386.000	36.06	54.00	17.94	15.20	H	314	1

Rg	Frequency [MHz]	PK+ Level [dBμV/m]	PK+ Limit [dBμV/m]	PK+ Margin [dB]	Correction [dB]	Polarization	Azimuth [deg]	Antenna Height [m]
6	5,327.500	103.28			15.13	H	221.8	2
6	5,350.000	50.51	74.00	23.49	15.18	H	0.9	2
6	5,372.500	50.87	74.00	23.13	15.18	H	359.1	1

ANTENNA POLARITY & TEST DISTANCE: VERTICAL AT 3 M

Rg	Frequency [MHz]	AVG Level [dBμV/m]	AVG Limit [dBμV/m]	AVG Margin [dB]	Correction [dB]	Polarization	Azimuth [deg]	Antenna Height [m]
6	5,328.000	87.89			15.13	V	139.4	1
6	5,350.000	35.81	54.00	18.19	15.18	V	5.1	1
6	5,385.500	36.03	54.00	17.97	15.20	V	0.9	2

Rg	Frequency [MHz]	PK+ Level [dBμV/m]	PK+ Limit [dBμV/m]	PK+ Margin [dB]	Correction [dB]	Polarization	Azimuth [deg]	Antenna Height [m]
6	5,328.000	100.99			15.13	V	140.6	1
6	5,350.000	49.83	74.00	24.17	15.18	V	140.6	1
6	5,354.000	51.21	74.00	22.79	15.18	V	293.6	1

REMARKS:

- Emission Level = Read Level+ Antenna Factor + Cable Loss- Preamp Factor
Margin value = Limit value – Emission Level.
- 5320MHz: Fundamental frequency.



802.11ax (20MHz) (RU106):

Worst case harmonic:

CHANNEL	TX Channel 64	DETECTOR FUNCTION	Peak (PK)
FREQUENCY RANGE	1GHz ~ 40GHz		Average (AV)

ANTENNA POLARITY & TEST DISTANCE: HORIZONTAL AT 3 M

Rg	Frequency [MHz]	PK+ Level [dBμV/m]	PK+ Limit [dBμV/m]	PK+ Margin [dB]	AVG Level [dBμV/m]	AVG Limit [dBμV/m]	AVG Margin [dB]	Correction [dB]	Polarization	Azimuth [deg]	Antenna Height [m]
4	10,640,000	46.13	74.00	27.87	34.38	54.00	19.62	11.35	H	358.5	1
4	15,960,000	48.44	74.00	25.56	37.65	54.00	16.35	17.66	H	358.5	1

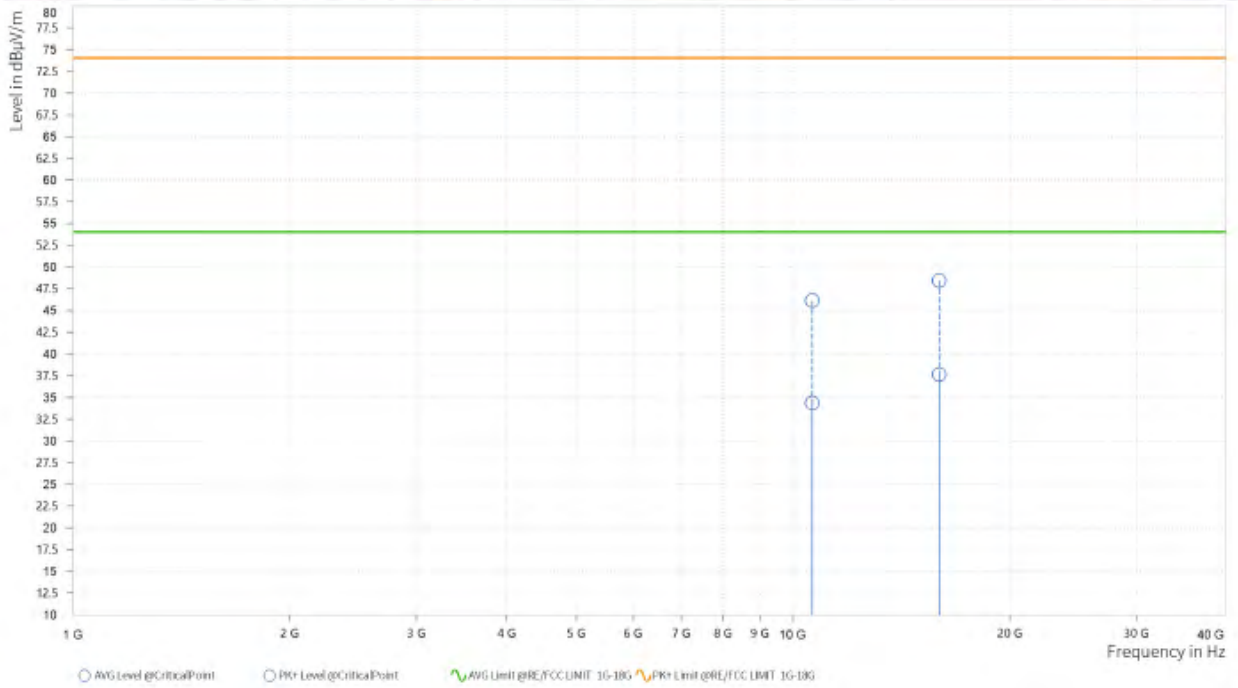



ANTENNA POLARITY & TEST DISTANCE: VERTICAL AT 3 M

Rg	Frequency [MHz]	PK+ Level [dBμV/m]	PK+ Limit [dBμV/m]	PK+ Margin [dB]	AVG Level [dBμV/m]	AVG Limit [dBμV/m]	AVG Margin [dB]	Correction [dB]	Polarization	Azimuth [deg]	Antenna Height [m]
4	10,640.000	44.93	74.00	29.07	34.31	54.00	19.69	11.35	V	359.1	1
4	15,960.000	48.49	74.00	25.51	37.69	54.00	16.31	17.66	V	0.9	2

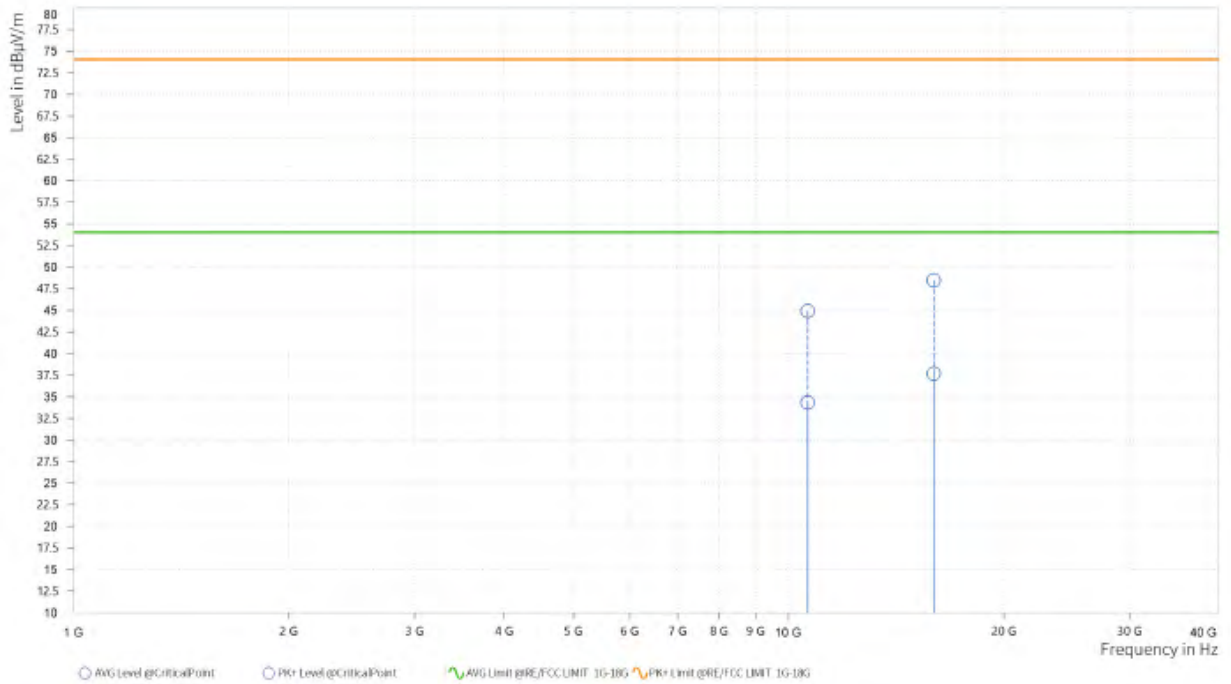

REMARKS:

- Emission Level = Read Level+ Antenna Factor + Cable Loss- Preamp Factor
Margin value = Limit value – Emission Level.
- 5320MHz: Fundamental frequency.



Band 3

802.11a

CHANNEL	TX Channel 100	DETECTOR FUNCTION	Peak (PK)
FREQUENCY RANGE	1GHz ~ 40GHz		Average (AV)

ANTENNA POLARITY & TEST DISTANCE: HORIZONTAL AT 3 M

Rg	Frequency [MHz]	AVG Level [dBμV/m]	AVG Limit [dBμV/m]	AVG Margin [dB]	Correction [dB]	Polarization	Azimuth [deg]	Antenna Height [m]
7	5,458.000	35.81	54.00	18.19	15.29	H	357.6	1
7	5,460.000	35.81	54.00	18.19	15.29	H	43.8	1
7	5,495.500	88.55			15.35	H	90.5	1

Rg	Frequency [MHz]	PK+ Level [dBμV/m]	PK+ Limit [dBμV/m]	PK+ Margin [dB]	Correction [dB]	Polarization	Azimuth [deg]	Antenna Height [m]
7	5,450.000	50.98	74.00	23.02	15.30	H	335.4	1
7	5,460.000	49.63	74.00	24.37	15.29	H	1	1
7	5,501.000	100.24			15.38	H	90.5	1

ANTENNA POLARITY & TEST DISTANCE: VERTICAL AT 3 M

Rg	Frequency [MHz]	AVG Level [dBμV/m]	AVG Limit [dBμV/m]	AVG Margin [dB]	Correction [dB]	Polarization	Azimuth [deg]	Antenna Height [m]
7	5,456.000	35.98	54.00	18.02	15.29	V	137	1
7	5,460.000	35.88	54.00	18.12	15.29	V	137	1
7	5,497.500	88.82			15.36	V	79.7	2

Rg	Frequency [MHz]	PK+ Level [dBμV/m]	PK+ Limit [dBμV/m]	PK+ Margin [dB]	Correction [dB]	Polarization	Azimuth [deg]	Antenna Height [m]
7	5,458.500	50.77	74.00	23.23	15.29	V	278.1	1
7	5,460.000	49.62	74.00	24.38	15.29	V	270.8	2
7	5,496.500	99.81			15.36	V	5.2	1

REMARKS:

- Emission Level = Read Level+ Antenna Factor + Cable Loss- Preamp Factor
Margin value = Limit value – Emission Level.
- 5500MHz: Fundamental frequency.
- #: Out of restricted band.



CHANNEL	TX Channel 116	DETECTOR FUNCTION	Peak (PK)
FREQUENCY RANGE	1GHz ~ 40GHz		Average (AV)

ANTENNA POLARITY & TEST DISTANCE: HORIZONTAL AT 3 M

Rg	Frequency [MHz]	AVG Level [dBµV/m]	AVG Limit [dBµV/m]	AVG Margin [dB]	Correction [dB]	Polarization	Azimuth [deg]	Antenna Height [m]
8	5,459.000	36.00	54.00	18.00	15.29	H	174.1	1
8	5,460.000	35.91	54.00	18.09	15.29	H	174.1	1
8	5,575.500	89.43			15.67	H	245.8	2

Rg	Frequency [MHz]	PK+ Level [dBµV/m]	PK+ Limit [dBµV/m]	PK+ Margin [dB]	Correction [dB]	Polarization	Azimuth [deg]	Antenna Height [m]
8	5,455.000	50.88	74.00	23.12	15.29	H	359.1	1
8	5,460.000	49.18	74.00	24.82	15.29	H	0.9	2
8	5,576.000	98.87			15.68	H	91.6	1

ANTENNA POLARITY & TEST DISTANCE: VERTICAL AT 3 M

Rg	Frequency [MHz]	AVG Level [dBµV/m]	AVG Limit [dBµV/m]	AVG Margin [dB]	Correction [dB]	Polarization	Azimuth [deg]	Antenna Height [m]
8	5,455.000	35.92	54.00	18.08	15.29	V	186	2
8	5,460.000	35.87	54.00	18.13	15.29	V	304.4	2
8	5,582.000	90.80			15.70	V	114.2	1

Rg	Frequency [MHz]	PK+ Level [dBµV/m]	PK+ Limit [dBµV/m]	PK+ Margin [dB]	Correction [dB]	Polarization	Azimuth [deg]	Antenna Height [m]
8	5,433.000	50.94	74.00	23.06	15.30	V	137	1
8	5,460.000	50.48	74.00	23.52	15.29	V	184.8	1
8	5,583.500	100.54			15.71	V	126.2	2

REMARKS:

1. Emission Level = Read Level+ Antenna Factor + Cable Loss- Preamp Factor
Margin value = Limit value – Emission Level.
2. 5580MHz: Fundamental frequency.
3. #: Out of restricted band.



CHANNEL	TX Channel 140	DETECTOR FUNCTION	Peak (PK)
FREQUENCY RANGE	1GHz ~ 40GHz		Average (AV)

ANTENNA POLARITY & TEST DISTANCE: HORIZONTAL AT 3 M

Rg	Frequency [MHz]	PK+ Level [dBµV/m]	PK+ Limit [dBµV/m]	PK+ Margin [dB]	Correction [dB]	Polarization	Azimuth [deg]	Antenna Height [m]
10	5,698.500	100.82			16.42	H	138.2	1
10	5,725.000	50.51	68.20	17.69	16.42	H	317.5	2
10	5,729.000	51.61	68.20	16.59	16.41	H	356.7	1

ANTENNA POLARITY & TEST DISTANCE: VERTICAL AT 3 M

Rg	Frequency [MHz]	PK+ Level [dBµV/m]	PK+ Limit [dBµV/m]	PK+ Margin [dB]	Correction [dB]	Polarization	Azimuth [deg]	Antenna Height [m]
10	5,696.000	101.44			16.39	V	269.6	2
10	5,725.000	51.23	68.20	16.97	16.42	V	14.9	2
10	5,732.000	51.55	68.20	16.65	16.41	V	90.5	1

REMARKS:

- Emission Level = Read Level+ Antenna Factor + Cable Loss- Preamp Factor
Margin value = Limit value – Emission Level.
- 5700MHz: Fundamental frequency.
- #: Out of restricted band.



CHANNEL	TX Channel 144	DETECTOR FUNCTION	Peak (PK)
FREQUENCY RANGE	1GHz ~ 40GHz		Average (AV)

ANTENNA POLARITY & TEST DISTANCE: HORIZONTAL AT 3 M

Rg	Frequency [MHz]	PK+ Level [dBμV/m]	PK+ Limit [dBμV/m]	PK+ Margin [dB]	Correction [dB]	Polarization	Azimuth [deg]	Antenna Height [m]
9	5,723.000	100.37			16.43	H	138.2	1
9	5,850.000	50.24	68.20	17.96	16.64	H	43.7	1
9	5,881.000	52.38	68.20	15.82	16.94	H	329.4	1

ANTENNA POLARITY & TEST DISTANCE: VERTICAL AT 3 M

Rg	Frequency [MHz]	PK+ Level [dBμV/m]	PK+ Limit [dBμV/m]	PK+ Margin [dB]	Correction [dB]	Polarization	Azimuth [deg]	Antenna Height [m]
9	5,717.500	102.75			16.44	V	221.9	2
9	5,850.000	50.71	68.20	17.49	16.64	V	5.1	1
9	5,881.500	52.88	68.20	15.32	16.94	V	359.1	1

REMARKS:

- Emission Level = Read Level+ Antenna Factor + Cable Loss- Preamp Factor
Margin value = Limit value – Emission Level.
- 5720MHz: Fundamental frequency.
- #: Out of restricted band.



802.11n (20MHz)

CHANNEL	TX Channel 100	DETECTOR FUNCTION	Peak (PK)
FREQUENCY RANGE	1GHz ~ 40GHz		Average (AV)

ANTENNA POLARITY & TEST DISTANCE: HORIZONTAL AT 3 M

Rg	Frequency [MHz]	AVG Level [dBμV/m]	AVG Limit [dBμV/m]	AVG Margin [dB]	Correction [dB]	Polarization	Azimuth [deg]	Antenna Height [m]
7	5,431.500	36.06	54.00	17.94	15.30	H	170.6	2
7	5,460.000	35.83	54.00	18.17	15.29	H	220.7	2
7	5,506.500	87.62			15.40	H	220.7	2

Rg	Frequency [MHz]	PK+ Level [dBμV/m]	PK+ Limit [dBμV/m]	PK+ Margin [dB]	Correction [dB]	Polarization	Azimuth [deg]	Antenna Height [m]
7	5,432.000	50.91	74.00	23.09	15.30	H	139.4	1
7	5,460.000	49.71	74.00	24.29	15.29	H	359.1	1
7	5,501.500	100.21			15.38	H	90.4	1

ANTENNA POLARITY & TEST DISTANCE: VERTICAL AT 3 M

Rg	Frequency [MHz]	AVG Level [dBμV/m]	AVG Limit [dBμV/m]	AVG Margin [dB]	Correction [dB]	Polarization	Azimuth [deg]	Antenna Height [m]
7	5,430.500	36.07	54.00	17.93	15.30	V	0.9	1
7	5,460.000	35.82	54.00	18.18	15.29	V	313.9	1
7	5,494.500	88.86			15.35	V	64.1	1

Rg	Frequency [MHz]	PK+ Level [dBμV/m]	PK+ Limit [dBμV/m]	PK+ Margin [dB]	Correction [dB]	Polarization	Azimuth [deg]	Antenna Height [m]
7	5,439.000	50.99	74.00	23.01	15.30	V	359.1	2
7	5,460.000	49.89	74.00	24.11	15.29	V	329.4	2
7	5,498.500	101.77			15.37	V	43.7	2

REMARKS:

1. Emission Level = Read Level+ Antenna Factor + Cable Loss- Preamp Factor
Margin value = Limit value – Emission Level.
2. 5500MHz: Fundamental frequency.
3. #: Out of restricted band.



CHANNEL	TX Channel 116	DETECTOR FUNCTION	Peak (PK)
FREQUENCY RANGE	1GHz ~ 40GHz		Average (AV)

ANTENNA POLARITY & TEST DISTANCE: HORIZONTAL AT 3 M

Rg	Frequency [MHz]	AVG Level [dBμV/m]	AVG Limit [dBμV/m]	AVG Margin [dB]	Correction [dB]	Polarization	Azimuth [deg]	Antenna Height [m]
8	5,434.500	36.34	54.00	17.66	15.30	H	177.7	1
8	5,460.000	35.87	54.00	18.13	15.29	H	236.2	1
8	5,581.000	87.26			15.70	H	117.8	1

Rg	Frequency [MHz]	PK+ Level [dBμV/m]	PK+ Limit [dBμV/m]	PK+ Margin [dB]	Correction [dB]	Polarization	Azimuth [deg]	Antenna Height [m]
8	5,432.500	51.25	74.00	22.75	15.30	H	72.4	2
8	5,460.000	49.49	74.00	24.51	15.29	H	287.6	1
8	5,584.000	99.52			15.71	H	219.4	2

ANTENNA POLARITY & TEST DISTANCE: VERTICAL AT 3 M

Rg	Frequency [MHz]	AVG Level [dBμV/m]	AVG Limit [dBμV/m]	AVG Margin [dB]	Correction [dB]	Polarization	Azimuth [deg]	Antenna Height [m]
8	5,433.000	36.24	54.00	17.76	15.30	V	66.5	2
8	5,460.000	35.91	54.00	18.09	15.29	V	184.8	1
8	5,581.000	85.52			15.70	V	184.8	1

Rg	Frequency [MHz]	PK+ Level [dBμV/m]	PK+ Limit [dBμV/m]	PK+ Margin [dB]	Correction [dB]	Polarization	Azimuth [deg]	Antenna Height [m]
8	5,447.500	51.36	74.00	22.64	15.30	V	73.6	1
8	5,460.000	49.98	74.00	24.02	15.29	V	357.7	2
8	5,577.500	100.27			15.68	V	43.7	2

REMARKS:

1. Emission Level = Read Level+ Antenna Factor + Cable Loss- Preamp Factor
Margin value = Limit value – Emission Level.
2. 5580MHz: Fundamental frequency.
3. #: Out of restricted band.



CHANNEL	TX Channel 140	DETECTOR FUNCTION	Peak (PK)
FREQUENCY RANGE	1GHz ~ 40GHz		Average (AV)

ANTENNA POLARITY & TEST DISTANCE: HORIZONTAL AT 3 M

Rg	Frequency [MHz]	PK+ Level [dBμV/m]	PK+ Limit [dBμV/m]	PK+ Margin [dB]	Correction [dB]	Polarization	Azimuth [deg]	Antenna Height [m]
9	5,697.000	102.22			16.40	H	138.2	1
9	5,725.000	51.02	68.20	17.18	16.42	H	74.8	2
9	5,744.000	51.58	68.20	16.62	16.37	H	138.2	1

ANTENNA POLARITY & TEST DISTANCE: VERTICAL AT 3 M

Rg	Frequency [MHz]	PK+ Level [dBμV/m]	PK+ Limit [dBμV/m]	PK+ Margin [dB]	Correction [dB]	Polarization	Azimuth [deg]	Antenna Height [m]
9	5,701.000	99.88			16.45	V	220.6	1
9	5,725.000	50.78	68.20	17.42	16.42	V	337.5	2
9	5,732.500	51.50	68.20	16.70	16.40	V	268.5	1

REMARKS:

- Emission Level = Read Level+ Antenna Factor + Cable Loss- Preamp Factor
Margin value = Limit value – Emission Level.
- 5700MHz: Fundamental frequency.
- #: Out of restricted band.



CHANNEL	TX Channel 144	DETECTOR FUNCTION	Peak (PK)
FREQUENCY RANGE	1GHz ~ 40GHz		Average (AV)

ANTENNA POLARITY & TEST DISTANCE: HORIZONTAL AT 3 M

Rg	Frequency [MHz]	PK+ Level [dBμV/m]	PK+ Limit [dBμV/m]	PK+ Margin [dB]	Correction [dB]	Polarization	Azimuth [deg]	Antenna Height [m]
10	5,725.500	99.58			16.42	H	137	1
10	5,850.000	50.84	68.20	17.36	16.64	H	359	2
10	5,895.000	51.95	68.20	16.25	16.87	H	31.8	2

ANTENNA POLARITY & TEST DISTANCE: VERTICAL AT 3 M

Rg	Frequency [MHz]	PK+ Level [dBμV/m]	PK+ Limit [dBμV/m]	PK+ Margin [dB]	Correction [dB]	Polarization	Azimuth [deg]	Antenna Height [m]
10	5,721.500	103.08			16.43	V	138.2	1
10	5,850.000	50.24	68.20	17.96	16.64	V	359	2
10	5,890.000	52.17	68.20	16.03	16.90	V	357.5	1

REMARKS:

- Emission Level = Read Level+ Antenna Factor + Cable Loss- Preamp Factor
Margin value = Limit value – Emission Level.
- 5720MHz: Fundamental frequency.
- #: Out of restricted band.



802.11n (40MHz)

CHANNEL	TX Channel 102	DETECTOR FUNCTION	Peak (PK)
FREQUENCY RANGE	1GHz ~ 40GHz		Average (AV)

ANTENNA POLARITY & TEST DISTANCE: HORIZONTAL AT 3 M

Rg	Frequency [MHz]	AVG Level [dBμV/m]	AVG Limit [dBμV/m]	AVG Margin [dB]	Correction [dB]	Polarization	Azimuth [deg]	Antenna Height [m]
5	5,458.000	37.80	54.00	16.20	13.28	H	305.3	1
5	5,460.000	37.97	54.00	16.03	13.28	H	305.3	1
5	5,511.500	92.77			13.32	H	355	2

Rg	Frequency [MHz]	PK+ Level [dBμV/m]	PK+ Limit [dBμV/m]	PK+ Margin [dB]	Correction [dB]	Polarization	Azimuth [deg]	Antenna Height [m]
5	5,445.500	52.79	74.00	21.21	13.28	H	305.4	1
5	5,460.000	51.43	74.00	22.57	13.28	H	305.4	1
5	5,520.000	104.48			13.34	H	355.1	2

ANTENNA POLARITY & TEST DISTANCE: VERTICAL AT 3 M

Rg	Frequency [MHz]	AVG Level [dBμV/m]	AVG Limit [dBμV/m]	AVG Margin [dB]	Correction [dB]	Polarization	Azimuth [deg]	Antenna Height [m]
5	5,457.500	37.06	54.00	16.94	13.28	V	353.8	1
5	5,460.000	37.18	54.00	16.82	13.28	V	353.8	1
5	5,499.000	93.61			13.30	V	1	1

Rg	Frequency [MHz]	PK+ Level [dBμV/m]	PK+ Limit [dBμV/m]	PK+ Margin [dB]	Correction [dB]	Polarization	Azimuth [deg]	Antenna Height [m]
5	5,458.000	51.78	74.00	22.22	13.28	V	358.6	1
5	5,460.000	51.76	74.00	22.24	13.28	V	359.1	1
5	5,500.000	105.38			13.30	V	1	1

REMARKS:

- Emission Level = Read Level+ Antenna Factor + Cable Loss- Preamp Factor
Margin value = Limit value – Emission Level.
- 5510MHz: Fundamental frequency.
- #: Out of restricted band.



CHANNEL	TX Channel 110	DETECTOR FUNCTION	Peak (PK)
FREQUENCY RANGE	1GHz ~ 40GHz		Average (AV)

ANTENNA POLARITY & TEST DISTANCE: HORIZONTAL AT 3 M

Rg	Frequency [MHz]	AVG Level [dBμV/m]	AVG Limit [dBμV/m]	AVG Margin [dB]	Correction [dB]	Polarization	Azimuth [deg]	Antenna Height [m]
6	5,456.500	36.57	54.00	17.43	13.28	H	288.6	1
6	5,460.000	36.55	54.00	17.45	13.28	H	288.6	1
6	5,547.500	93.89			13.35	H	5.7	1

Rg	Frequency [MHz]	PK+ Level [dBμV/m]	PK+ Limit [dBμV/m]	PK+ Margin [dB]	Correction [dB]	Polarization	Azimuth [deg]	Antenna Height [m]
6	5,457.500	50.60	74.00	23.40	13.28	H	111.7	1
6	5,460.000	49.55	74.00	24.45	13.28	H	71.4	2
6	5,547.000	105.48			13.36	H	5	1

ANTENNA POLARITY & TEST DISTANCE: VERTICAL AT 3 M

Rg	Frequency [MHz]	AVG Level [dBμV/m]	AVG Limit [dBμV/m]	AVG Margin [dB]	Correction [dB]	Polarization	Azimuth [deg]	Antenna Height [m]
6	5,457.000	36.52	54.00	17.48	13.28	V	343.6	1
6	5,460.000	36.44	54.00	17.56	13.28	V	343.6	1
6	5,548.500	93.99			13.35	V	1	1

Rg	Frequency [MHz]	PK+ Level [dBμV/m]	PK+ Limit [dBμV/m]	PK+ Margin [dB]	Correction [dB]	Polarization	Azimuth [deg]	Antenna Height [m]
6	5,447.000	51.29	74.00	22.71	13.28	V	48.7	2
6	5,460.000	49.62	74.00	24.38	13.28	V	236.3	2
6	5,559.500	105.40			13.37	V	1	1

REMARKS:

1. Emission Level = Read Level+ Antenna Factor + Cable Loss- Preamp Factor
Margin value = Limit value – Emission Level.
2. 5500MHz: Fundamental frequency.
3. #: Out of restricted band.



CHANNEL	TX Channel 134	DETECTOR FUNCTION	Peak (PK)
FREQUENCY RANGE	1GHz ~ 40GHz		Average (AV)

ANTENNA POLARITY & TEST DISTANCE: HORIZONTAL AT 3 M

Rg	Frequency [MHz]	PK+ Level [dBμV/m]	PK+ Limit [dBμV/m]	PK+ Margin [dB]	Correction [dB]	Polarization	Azimuth [deg]	Antenna Height [m]
7	5,664.500	104.14			13.81	H	288.6	1
7	5,725.000	50.55	68.20	17.65	14.01	H	53.2	1
7	5,734.000	51.50	68.20	16.70	14.02	H	355	2

ANTENNA POLARITY & TEST DISTANCE: VERTICAL AT 3 M

Rg	Frequency [MHz]	PK+ Level [dBμV/m]	PK+ Limit [dBμV/m]	PK+ Margin [dB]	Correction [dB]	Polarization	Azimuth [deg]	Antenna Height [m]
7	5,669.000	106.27			13.83	V	359.2	1
7	5,725.000	50.65	68.20	17.55	14.01	V	345.8	1
7	5,728.500	52.62	68.20	15.58	14.01	V	1	1

REMARKS:

1. Emission Level = Read Level+ Antenna Factor + Cable Loss- Preamp Factor
Margin value = Limit value – Emission Level.
2. 5670MHz: Fundamental frequency.
3. #: Out of restricted band.



CHANNEL	TX Channel 142	DETECTOR FUNCTION	Peak (PK)
FREQUENCY RANGE	1GHz ~ 40GHz		Average (AV)

ANTENNA POLARITY & TEST DISTANCE: HORIZONTAL AT 3 M

Rg	Frequency [MHz]	PK+ Level [dBμV/m]	PK+ Limit [dBμV/m]	PK+ Margin [dB]	Correction [dB]	Polarization	Azimuth [deg]	Antenna Height [m]
8	5,712.500	103.97			14.00	H	287.4	1
8	5,850.000	50.38	68.20	17.82	14.28	H	287.4	1
8	5,873.500	51.25	68.20	16.95	14.40	H	247.1	2

ANTENNA POLARITY & TEST DISTANCE: VERTICAL AT 3 M

Rg	Frequency [MHz]	PK+ Level [dBμV/m]	PK+ Limit [dBμV/m]	PK+ Margin [dB]	Correction [dB]	Polarization	Azimuth [deg]	Antenna Height [m]
8	5,708.500	106.04			14.00	V	359.1	1
8	5,850.000	49.99	68.20	18.21	14.28	V	359	1
8	5,865.500	51.78	68.20	16.42	14.36	V	1	1

REMARKS:

- Emission Level = Read Level+ Antenna Factor + Cable Loss- Preamp Factor
Margin value = Limit value – Emission Level.
- 5710MHz: Fundamental frequency.
- #: Out of restricted band.



802.11ac (20MHz)

CHANNEL	TX Channel 100	DETECTOR FUNCTION	Peak (PK)
FREQUENCY RANGE	1GHz ~ 40GHz		Average (AV)

ANTENNA POLARITY & TEST DISTANCE: HORIZONTAL AT 3 M

Rg	Frequency [MHz]	AVG Level [dBμV/m]	AVG Limit [dBμV/m]	AVG Margin [dB]	Correction [dB]	Polarization	Azimuth [deg]	Antenna Height [m]
7	5,458.000	35.91	54.00	18.09	15.29	H	355.5	1
7	5,460.000	35.84	54.00	18.16	15.29	H	345.8	2
7	5,494.500	85.38			15.35	H	94	2

Rg	Frequency [MHz]	PK+ Level [dBμV/m]	PK+ Limit [dBμV/m]	PK+ Margin [dB]	Correction [dB]	Polarization	Azimuth [deg]	Antenna Height [m]
7	5,457.500	51.17	74.00	22.83	15.29	H	137	2
7	5,460.000	49.25	74.00	24.75	15.29	H	357.6	2
7	5,501.500	97.91			15.38	H	90.5	2

ANTENNA POLARITY & TEST DISTANCE: VERTICAL AT 3 M

Rg	Frequency [MHz]	AVG Level [dBμV/m]	AVG Limit [dBμV/m]	AVG Margin [dB]	Correction [dB]	Polarization	Azimuth [deg]	Antenna Height [m]
7	5,457.000	35.94	54.00	18.06	15.29	V	145.4	2
7	5,460.000	35.93	54.00	18.07	15.29	V	145.4	2
7	5,501.500	88.65			15.38	V	145.4	2

Rg	Frequency [MHz]	PK+ Level [dBμV/m]	PK+ Limit [dBμV/m]	PK+ Margin [dB]	Correction [dB]	Polarization	Azimuth [deg]	Antenna Height [m]
7	5,447.000	51.18	74.00	22.82	15.30	V	125	1
7	5,460.000	49.84	74.00	24.16	15.29	V	188.4	2
7	5,499.000	100.12			15.37	V	43.8	2

REMARKS:

- Emission Level = Read Level+ Antenna Factor + Cable Loss- Preamp Factor
Margin value = Limit value – Emission Level.
- 5500MHz: Fundamental frequency.
- #: Out of restricted band.



CHANNEL	TX Channel 116	DETECTOR FUNCTION	Peak (PK)
FREQUENCY RANGE	1GHz ~ 40GHz		Average (AV)

ANTENNA POLARITY & TEST DISTANCE: HORIZONTAL AT 3 M

Rg	Frequency [MHz]	AVG Level [dBμV/m]	AVG Limit [dBμV/m]	AVG Margin [dB]	Correction [dB]	Polarization	Azimuth [deg]	Antenna Height [m]
8	5,452.500	36.01	54.00	17.99	15.30	H	171.7	1
8	5,460.000	35.89	54.00	18.11	15.29	H	359	1
8	5,583.000	89.95			15.71	H	219.4	1

Rg	Frequency [MHz]	PK+ Level [dBμV/m]	PK+ Limit [dBμV/m]	PK+ Margin [dB]	Correction [dB]	Polarization	Azimuth [deg]	Antenna Height [m]
8	5,457.500	50.78	74.00	23.22	15.29	H	268.4	1
8	5,460.000	49.33	74.00	24.67	15.29	H	355.4	1
8	5,581.000	101.32			15.70	H	139.4	2

ANTENNA POLARITY & TEST DISTANCE: VERTICAL AT 3 M

Rg	Frequency [MHz]	AVG Level [dBμV/m]	AVG Limit [dBμV/m]	AVG Margin [dB]	Correction [dB]	Polarization	Azimuth [deg]	Antenna Height [m]
8	5,446.000	36.15	54.00	17.85	15.30	V	172.9	1
8	5,460.000	35.99	54.00	18.01	15.29	V	220.6	1
8	5,581.000	86.64			15.70	V	220.6	1

Rg	Frequency [MHz]	PK+ Level [dBμV/m]	PK+ Limit [dBμV/m]	PK+ Margin [dB]	Correction [dB]	Polarization	Azimuth [deg]	Antenna Height [m]
8	5,440.000	51.31	74.00	22.69	15.30	V	1	1
8	5,460.000	49.32	74.00	24.68	15.29	V	269.6	1
8	5,580.500	98.71			15.70	V	220.6	1

REMARKS:

- Emission Level = Read Level+ Antenna Factor + Cable Loss- Preamp Factor
Margin value = Limit value – Emission Level.
- 5580MHz: Fundamental frequency.
- #: Out of restricted band.



CHANNEL	TX Channel 140	DETECTOR FUNCTION	Peak (PK)
FREQUENCY RANGE	1GHz ~ 40GHz		Average (AV)

ANTENNA POLARITY & TEST DISTANCE: HORIZONTAL AT 3 M

Rg	Frequency [MHz]	PK+ Level [dBμV/m]	PK+ Limit [dBμV/m]	PK+ Margin [dB]	Correction [dB]	Polarization	Azimuth [deg]	Antenna Height [m]
9	5,697.000	99.63			16.40	H	134.6	2
9	5,725.000	50.47	68.20	17.73	16.42	H	178.9	1
9	5,749.000	51.71	68.20	16.49	16.36	H	226.6	1

ANTENNA POLARITY & TEST DISTANCE: VERTICAL AT 3 M

Rg	Frequency [MHz]	PK+ Level [dBμV/m]	PK+ Limit [dBμV/m]	PK+ Margin [dB]	Correction [dB]	Polarization	Azimuth [deg]	Antenna Height [m]
9	5,702.000	100.47			16.46	V	219.4	1
9	5,725.000	51.33	68.20	16.87	16.42	V	316.3	1
9	5,726.000	51.55	68.20	16.65	16.42	V	1	1

REMARKS:

1. Emission Level = Read Level+ Antenna Factor + Cable Loss- Preamp Factor
Margin value = Limit value – Emission Level.
2. 5700MHz: Fundamental frequency.
3. #: Out of restricted band.



CHANNEL	TX Channel 144	DETECTOR FUNCTION	Peak (PK)
FREQUENCY RANGE	1GHz ~ 40GHz		Average (AV)

ANTENNA POLARITY & TEST DISTANCE: HORIZONTAL AT 3 M

Rg	Frequency [MHz]	PK+ Level [dBμV/m]	PK+ Limit [dBμV/m]	PK+ Margin [dB]	Correction [dB]	Polarization	Azimuth [deg]	Antenna Height [m]
10	5,712.500	99.19			16.46	H	140.6	2
10	5,850.000	50.58	68.20	17.62	16.64	H	187.2	2
10	5,884.500	52.21	68.20	15.99	16.93	H	140.6	2

ANTENNA POLARITY & TEST DISTANCE: VERTICAL AT 3 M

Rg	Frequency [MHz]	PK+ Level [dBμV/m]	PK+ Limit [dBμV/m]	PK+ Margin [dB]	Correction [dB]	Polarization	Azimuth [deg]	Antenna Height [m]
10	5,720.500	102.26			16.44	V	220.6	1
10	5,850.000	50.92	68.20	17.28	16.64	V	0.9	1
10	5,891.000	52.60	68.20	15.60	16.89	V	140.6	2

REMARKS:

1. Emission Level = Read Level+ Antenna Factor + Cable Loss- Preamp Factor
Margin value = Limit value – Emission Level.
2. 5720MHz: Fundamental frequency.
3. #: Out of restricted band.



802.11ac (40MHz)

CHANNEL	TX Channel 102	DETECTOR FUNCTION	Peak (PK)
FREQUENCY RANGE	1GHz ~ 40GHz		Average (AV)

ANTENNA POLARITY & TEST DISTANCE: HORIZONTAL AT 3 M

Rg	Frequency [MHz]	AVG Level [dBμV/m]	AVG Limit [dBμV/m]	AVG Margin [dB]	Correction [dB]	Polarization	Azimuth [deg]	Antenna Height [m]
5	5,446.500	35.90	54.00	18.10	15.30	H	354.9	2
5	5,460.000	35.84	54.00	18.16	15.29	H	354.9	2
5	5,512.000	84.09			15.42	H	172.9	1

Rg	Frequency [MHz]	PK+ Level [dBμV/m]	PK+ Limit [dBμV/m]	PK+ Margin [dB]	Correction [dB]	Polarization	Azimuth [deg]	Antenna Height [m]
5	5,433.000	51.28	74.00	22.72	15.30	H	338.6	1
5	5,460.000	49.88	74.00	24.12	15.29	H	359.1	1
5	5,500.500	97.12			15.37	H	91.7	1

ANTENNA POLARITY & TEST DISTANCE: VERTICAL AT 3 M

Rg	Frequency [MHz]	AVG Level [dBμV/m]	AVG Limit [dBμV/m]	AVG Margin [dB]	Correction [dB]	Polarization	Azimuth [deg]	Antenna Height [m]
5	5,455.500	36.12	54.00	17.88	15.29	V	219.4	2
5	5,460.000	35.94	54.00	18.06	15.29	V	141.8	1
5	5,527.500	87.92			15.49	V	219.4	2

Rg	Frequency [MHz]	PK+ Level [dBμV/m]	PK+ Limit [dBμV/m]	PK+ Margin [dB]	Correction [dB]	Polarization	Azimuth [deg]	Antenna Height [m]
5	5,451.000	51.14	74.00	22.86	15.30	V	5.8	1
5	5,460.000	50.08	74.00	23.92	15.29	V	190.7	1
5	5,500.500	98.11			15.37	V	218.2	2

REMARKS:

- Emission Level = Read Level+ Antenna Factor + Cable Loss- Preamp Factor
Margin value = Limit value – Emission Level.
- 5510MHz: Fundamental frequency.
- #: Out of restricted band.



CHANNEL	TX Channel 110	DETECTOR FUNCTION	Peak (PK)
FREQUENCY RANGE	1GHz ~ 40GHz		Average (AV)

ANTENNA POLARITY & TEST DISTANCE: HORIZONTAL AT 3 M

Rg	Frequency [MHz]	AVG Level [dBµV/m]	AVG Limit [dBµV/m]	AVG Margin [dB]	Correction [dB]	Polarization	Azimuth [deg]	Antenna Height [m]
6	5,432.000	36.17	54.00	17.83	15.30	H	143	1
6	5,460.000	35.80	54.00	18.20	15.29	H	5.1	1
6	5,538.500	87.47			15.54	H	143	1

Rg	Frequency [MHz]	PK+ Level [dBµV/m]	PK+ Limit [dBµV/m]	PK+ Margin [dB]	Correction [dB]	Polarization	Azimuth [deg]	Antenna Height [m]
6	5,439.500	50.69	74.00	23.31	15.30	H	218.2	2
6	5,460.000	49.90	74.00	24.10	15.29	H	316.2	2
6	5,538.500	99.82			15.54	H	141.8	1

ANTENNA POLARITY & TEST DISTANCE: VERTICAL AT 3 M

Rg	Frequency [MHz]	AVG Level [dBµV/m]	AVG Limit [dBµV/m]	AVG Margin [dB]	Correction [dB]	Polarization	Azimuth [deg]	Antenna Height [m]
6	5,433.000	36.23	54.00	17.77	15.30	V	220.6	2
6	5,460.000	35.85	54.00	18.15	15.29	V	122.6	2
6	5,559.000	85.58			15.60	V	220.6	2

Rg	Frequency [MHz]	PK+ Level [dBµV/m]	PK+ Limit [dBµV/m]	PK+ Margin [dB]	Correction [dB]	Polarization	Azimuth [deg]	Antenna Height [m]
6	5,447.000	51.76	74.00	22.24	15.30	V	359	2
6	5,460.000	49.55	74.00	24.45	15.29	V	359.1	1
6	5,552.500	97.05			15.57	V	141.8	1

REMARKS:

1. Emission Level = Read Level+ Antenna Factor + Cable Loss- Preamp Factor
Margin value = Limit value – Emission Level.
2. 5500MHz: Fundamental frequency.
3. #: Out of restricted band.



CHANNEL	TX Channel 134	DETECTOR FUNCTION	Peak (PK)
FREQUENCY RANGE	1GHz ~ 40GHz		Average (AV)

ANTENNA POLARITY & TEST DISTANCE: HORIZONTAL AT 3 M

Rg	Frequency [MHz]	PK+ Level [dBμV/m]	PK+ Limit [dBμV/m]	PK+ Margin [dB]	Correction [dB]	Polarization	Azimuth [deg]	Antenna Height [m]
7	5,663.500	96.27			15.97	H	355	2
7	5,725.000	50.87	68.20	17.33	16.42	H	267.3	2
7	5,731.500	51.54	68.20	16.66	16.41	H	43.8	1

ANTENNA POLARITY & TEST DISTANCE: VERTICAL AT 3 M

Rg	Frequency [MHz]	PK+ Level [dBμV/m]	PK+ Limit [dBμV/m]	PK+ Margin [dB]	Correction [dB]	Polarization	Azimuth [deg]	Antenna Height [m]
7	5,660.500	96.50			15.93	V	359	1
7	5,725.000	50.64	68.20	17.56	16.42	V	1	1
7	5,732.000	52.17	68.20	16.03	16.41	V	140.6	1

REMARKS:

- Emission Level = Read Level+ Antenna Factor + Cable Loss- Preamp Factor
Margin value = Limit value – Emission Level.
- 5670MHz: Fundamental frequency.
- #: Out of restricted band.



CHANNEL	TX Channel 142	DETECTOR FUNCTION	Peak (PK)
FREQUENCY RANGE	1GHz ~ 40GHz		Average (AV)

ANTENNA POLARITY & TEST DISTANCE: HORIZONTAL AT 3 M

Rg	Frequency [MHz]	PK+ Level [dBμV/m]	PK+ Limit [dBμV/m]	PK+ Margin [dB]	Correction [dB]	Polarization	Azimuth [deg]	Antenna Height [m]
8	5,717.500	97.77			16.44	H	138.2	1
8	5,850.000	50.26	68.20	17.94	16.64	H	42.5	1
8	5,885.500	52.07	68.20	16.13	16.92	H	0.9	2

ANTENNA POLARITY & TEST DISTANCE: VERTICAL AT 3 M

Rg	Frequency [MHz]	PK+ Level [dBμV/m]	PK+ Limit [dBμV/m]	PK+ Margin [dB]	Correction [dB]	Polarization	Azimuth [deg]	Antenna Height [m]
8	5,700.500	100.44			16.44	V	137	1
8	5,850.000	50.55	68.20	17.65	16.64	V	90.5	1
8	5,884.500	51.73	68.20	16.47	16.93	V	5.1	1

REMARKS:

- Emission Level = Read Level+ Antenna Factor + Cable Loss- Preamp Factor
Margin value = Limit value – Emission Level.
- 5710MHz: Fundamental frequency.
- #: Out of restricted band.



802.11ac (80MHz)

CHANNEL	TX Channel 106	DETECTOR FUNCTION	Peak (PK)
FREQUENCY RANGE	1GHz ~ 40GHz		Average (AV)

ANTENNA POLARITY & TEST DISTANCE: HORIZONTAL AT 3 M

Rg	Frequency [MHz]	AVG Level [dBµV/m]	AVG Limit [dBµV/m]	AVG Margin [dB]	Correction [dB]	Polarization	Azimuth [deg]	Antenna Height [m]
3	5,407.500	36.75	54.00	17.25	13.23	H	4.3	1
3	5,460.000	36.31	54.00	17.69	13.28	H	4.3	1
3	5,519.000	77.48			13.33	H	359.1	1

Rg	Frequency [MHz]	PK+ Level [dBµV/m]	PK+ Limit [dBµV/m]	PK+ Margin [dB]	Correction [dB]	Polarization	Azimuth [deg]	Antenna Height [m]
3	5,442.500	51.97	74.00	22.03	13.28	H	4.3	1
3	5,460.000	50.62	74.00	23.38	13.28	H	359	2
3	5,549.000	100.69			13.35	H	4.3	1

ANTENNA POLARITY & TEST DISTANCE: VERTICAL AT 3 M

Rg	Frequency [MHz]	AVG Level [dBµV/m]	AVG Limit [dBµV/m]	AVG Margin [dB]	Correction [dB]	Polarization	Azimuth [deg]	Antenna Height [m]
3	5,450.000	39.00	54.00	15.00	13.28	V	359.1	1
3	5,460.000	39.50	54.00	14.50	13.28	V	359.1	1
3	5,539.500	89.06			13.36	V	1	1

Rg	Frequency [MHz]	PK+ Level [dBµV/m]	PK+ Limit [dBµV/m]	PK+ Margin [dB]	Correction [dB]	Polarization	Azimuth [deg]	Antenna Height [m]
3	5,449.000	53.40	74.00	20.60	13.28	V	359	1
3	5,460.000	53.09	74.00	20.91	13.28	V	357.8	1
3	5,541.500	100.49			13.36	V	1	1

REMARKS:

- Emission Level = Read Level+ Antenna Factor + Cable Loss- Preamp Factor
Margin value = Limit value – Emission Level.
- 5530MHz: Fundamental frequency.
- #: Out of restricted band.



CHANNEL	TX Channel 122	DETECTOR FUNCTION	Peak (PK)
FREQUENCY RANGE	1GHz ~ 40GHz		Average (AV)

ANTENNA POLARITY & TEST DISTANCE: HORIZONTAL AT 3 M

Rg	Frequency [MHz]	PK+ Level [dBµV/m]	PK+ Limit [dBµV/m]	PK+ Margin [dB]	Correction [dB]	Polarization	Azimuth [deg]	Antenna Height [m]
4	5,633.500	97.79			13.64	H	4.9	1
4	5,725.000	50.43	68.20	17.77	14.01	H	320.8	1
4	5,729.500	51.25	68.20	16.95	14.02	H	1	2

ANTENNA POLARITY & TEST DISTANCE: VERTICAL AT 3 M

Rg	Frequency [MHz]	PK+ Level [dBµV/m]	PK+ Limit [dBµV/m]	PK+ Margin [dB]	Correction [dB]	Polarization	Azimuth [deg]	Antenna Height [m]
4	5,629.000	100.88			13.62	V	359.1	1
4	5,725.000	49.77	68.20	18.43	14.01	V	317.4	1
4	5,743.500	51.52	68.20	16.68	14.03	V	5	1

REMARKS:

- Emission Level = Read Level+ Antenna Factor + Cable Loss- Preamp Factor
Margin value = Limit value – Emission Level.
- 5610MHz: Fundamental frequency.
- #: Out of restricted band.



CHANNEL	TX Channel 138	DETECTOR FUNCTION	Peak (PK)
FREQUENCY RANGE	1GHz ~ 40GHz		Average (AV)

ANTENNA POLARITY & TEST DISTANCE: HORIZONTAL AT 3 M

Rg	Frequency [MHz]	PK+ Level [dBµV/m]	PK+ Limit [dBµV/m]	PK+ Margin [dB]	Correction [dB]	Polarization	Azimuth [deg]	Antenna Height [m]
5	5,684.500	97.93			13.91	H	60.2	1
5	5,850.000	49.48	68.20	18.72	14.28	H	123.6	1
5	5,893.000	51.89	68.20	16.31	14.45	H	355.7	2

ANTENNA POLARITY & TEST DISTANCE: VERTICAL AT 3 M

Rg	Frequency [MHz]	PK+ Level [dBµV/m]	PK+ Limit [dBµV/m]	PK+ Margin [dB]	Correction [dB]	Polarization	Azimuth [deg]	Antenna Height [m]
5	5,708.500	102.97			14.00	V	359.1	1
5	5,850.000	50.21	68.20	17.99	14.28	V	1	1
5	5,857.000	52.60	68.20	15.60	14.31	V	5.8	2

REMARKS:

- Emission Level = Read Level+ Antenna Factor + Cable Loss- Preamp Factor
Margin value = Limit value – Emission Level.
- 5690MHz: Fundamental frequency.
- #: Out of restricted band.



802.11ax (20MHz)

CHANNEL	TX Channel 100	DETECTOR FUNCTION	Peak (PK)
FREQUENCY RANGE	1GHz ~ 40GHz		Average (AV)

ANTENNA POLARITY & TEST DISTANCE: HORIZONTAL AT 3 M

Rg	Frequency [MHz]	AVG Level [dBμV/m]	AVG Limit [dBμV/m]	AVG Margin [dB]	Correction [dB]	Polarization	Azimuth [deg]	Antenna Height [m]
8	5,444.000	36.46	54.00	17.54	13.28	H	5.7	1
8	5,460.000	36.17	54.00	17.83	13.28	H	269.5	1
8	5,507.000	85.09			13.31	H	5.7	1

Rg	Frequency [MHz]	PK+ Level [dBμV/m]	PK+ Limit [dBμV/m]	PK+ Margin [dB]	Correction [dB]	Polarization	Azimuth [deg]	Antenna Height [m]
8	5,453.500	51.77	74.00	22.23	13.28	H	257.4	1
8	5,460.000	50.42	74.00	23.58	13.28	H	1	1
8	5,495.500	106.73			13.29	H	71.4	2

ANTENNA POLARITY & TEST DISTANCE: VERTICAL AT 3 M

Rg	Frequency [MHz]	AVG Level [dBμV/m]	AVG Limit [dBμV/m]	AVG Margin [dB]	Correction [dB]	Polarization	Azimuth [deg]	Antenna Height [m]
8	5,456.000	36.92	54.00	17.08	13.28	V	359.1	1
8	5,460.000	36.96	54.00	17.04	13.28	V	359.1	1
8	5,499.000	94.54			13.30	V	1	1

Rg	Frequency [MHz]	PK+ Level [dBμV/m]	PK+ Limit [dBμV/m]	PK+ Margin [dB]	Correction [dB]	Polarization	Azimuth [deg]	Antenna Height [m]
8	5,439.500	51.19	74.00	22.81	13.28	V	355.7	2
8	5,460.000	50.29	74.00	23.71	13.28	V	84.5	2
8	5,498.500	107.86			13.30	V	349.3	1

REMARKS:

- Emission Level = Read Level+ Antenna Factor + Cable Loss- Preamp Factor
Margin value = Limit value – Emission Level.
- 5500MHz: Fundamental frequency.
- #: Out of restricted band.



CHANNEL	TX Channel 116	DETECTOR FUNCTION	Peak (PK)
FREQUENCY RANGE	1GHz ~ 40GHz		Average (AV)

ANTENNA POLARITY & TEST DISTANCE: HORIZONTAL AT 3 M

Rg	Frequency [MHz]	AVG Level [dBμV/m]	AVG Limit [dBμV/m]	AVG Margin [dB]	Correction [dB]	Polarization	Azimuth [deg]	Antenna Height [m]
9	5,444.500	36.85	54.00	17.15	13.28	H	4.9	1
9	5,460.000	36.15	54.00	17.85	13.28	H	4.9	1
9	5,571.500	85.92			13.38	H	4.9	1

Rg	Frequency [MHz]	PK+ Level [dBμV/m]	PK+ Limit [dBμV/m]	PK+ Margin [dB]	Correction [dB]	Polarization	Azimuth [deg]	Antenna Height [m]
9	5,454.500	51.44	74.00	22.56	13.28	H	5	1
9	5,460.000	49.92	74.00	24.08	13.28	H	142	2
9	5,585.500	105.69			13.40	H	5	1

ANTENNA POLARITY & TEST DISTANCE: VERTICAL AT 3 M

Rg	Frequency [MHz]	AVG Level [dBμV/m]	AVG Limit [dBμV/m]	AVG Margin [dB]	Correction [dB]	Polarization	Azimuth [deg]	Antenna Height [m]
9	5,457.500	37.11	54.00	16.89	13.28	V	359.1	1
9	5,460.000	37.04	54.00	16.96	13.28	V	359.1	1
9	5,579.000	94.79			13.39	V	1	1

Rg	Frequency [MHz]	PK+ Level [dBμV/m]	PK+ Limit [dBμV/m]	PK+ Margin [dB]	Correction [dB]	Polarization	Azimuth [deg]	Antenna Height [m]
9	5,433.000	51.08	74.00	22.92	13.28	V	300.5	1
9	5,460.000	50.03	74.00	23.97	13.28	V	27.1	2
9	5,578.000	107.29			13.39	V	351.8	1

REMARKS:

1. Emission Level = Read Level+ Antenna Factor + Cable Loss- Preamp Factor
Margin value = Limit value – Emission Level.
2. 5580MHz: Fundamental frequency.
3. #: Out of restricted band.



CHANNEL	TX Channel 140	DETECTOR FUNCTION	Peak (PK)
FREQUENCY RANGE	1GHz ~ 40GHz		Average (AV)

ANTENNA POLARITY & TEST DISTANCE: HORIZONTAL AT 3 M

Rg	Frequency [MHz]	PK+ Level [dBμV/m]	PK+ Limit [dBμV/m]	PK+ Margin [dB]	Correction [dB]	Polarization	Azimuth [deg]	Antenna Height [m]
10	5,694.000	105.10			13.95	H	50.7	1
10	5,725.000	50.20	68.20	18.00	14.01	H	1	2
10	5,740.000	51.99	68.20	16.21	14.02	H	2	2

ANTENNA POLARITY & TEST DISTANCE: VERTICAL AT 3 M

Rg	Frequency [MHz]	PK+ Level [dBμV/m]	PK+ Limit [dBμV/m]	PK+ Margin [dB]	Correction [dB]	Polarization	Azimuth [deg]	Antenna Height [m]
10	5,698.500	109.20			13.98	V	359.2	1
10	5,725.000	51.55	68.20	16.65	14.01	V	357.9	1
10	5,725.500	52.11	68.20	16.09	14.01	V	359.2	1

REMARKS:

- Emission Level = Read Level+ Antenna Factor + Cable Loss- Preamp Factor
Margin value = Limit value – Emission Level.
- 5700MHz: Fundamental frequency.
- #: Out of restricted band.



CHANNEL	TX Channel 144	DETECTOR FUNCTION	Peak (PK)
FREQUENCY RANGE	1GHz ~ 40GHz		Average (AV)

ANTENNA POLARITY & TEST DISTANCE: HORIZONTAL AT 3 M

Rg	Frequency [MHz]	PK+ Level [dBμV/m]	PK+ Limit [dBμV/m]	PK+ Margin [dB]	Correction [dB]	Polarization	Azimuth [deg]	Antenna Height [m]
11	5,725.500	104.97			14.01	H	53.2	1
11	5,850.000	50.89	68.20	17.31	14.28	H	165.4	1
11	5,891.500	51.55	68.20	16.65	14.45	H	5	1

ANTENNA POLARITY & TEST DISTANCE: VERTICAL AT 3 M

Rg	Frequency [MHz]	PK+ Level [dBμV/m]	PK+ Limit [dBμV/m]	PK+ Margin [dB]	Correction [dB]	Polarization	Azimuth [deg]	Antenna Height [m]
11	5,718.000	109.67			14.01	V	359.1	1
11	5,850.000	51.34	68.20	16.86	14.28	V	251.8	2
11	5,899.500	52.73	68.20	15.47	14.47	V	359.1	1

REMARKS:

1. Emission Level = Read Level+ Antenna Factor + Cable Loss- Preamp Factor
Margin value = Limit value – Emission Level.
2. 5720MHz: Fundamental frequency.
3. #: Out of restricted band.



802.11ax (40MHz)

CHANNEL	TX Channel 102	DETECTOR FUNCTION	Peak (PK)
FREQUENCY RANGE	1GHz ~ 40GHz		Average (AV)

ANTENNA POLARITY & TEST DISTANCE: HORIZONTAL AT 3 M

Rg	Frequency [MHz]	AVG Level [dBμV/m]	AVG Limit [dBμV/m]	AVG Margin [dB]	Correction [dB]	Polarization	Azimuth [deg]	Antenna Height [m]
5	5,459.500	38.62	54.00	15.38	13.28	H	301.7	1
5	5,460.000	38.82	54.00	15.18	13.28	H	301.7	1
5	5,518.000	93.09			13.33	H	4.2	1

Rg	Frequency [MHz]	PK+ Level [dBμV/m]	PK+ Limit [dBμV/m]	PK+ Margin [dB]	Correction [dB]	Polarization	Azimuth [deg]	Antenna Height [m]
5	5,459.500	52.75	74.00	21.25	13.28	H	294.6	1
5	5,460.000	52.48	74.00	21.52	13.28	H	294.6	1
5	5,500.000	103.78			13.30	H	294.6	1

ANTENNA POLARITY & TEST DISTANCE: VERTICAL AT 3 M

Rg	Frequency [MHz]	AVG Level [dBμV/m]	AVG Limit [dBμV/m]	AVG Margin [dB]	Correction [dB]	Polarization	Azimuth [deg]	Antenna Height [m]
5	5,459.500	37.78	54.00	16.22	13.28	V	1	1
5	5,460.000	37.86	54.00	16.14	13.28	V	1	1
5	5,499.500	92.71			13.30	V	1	1

Rg	Frequency [MHz]	PK+ Level [dBμV/m]	PK+ Limit [dBμV/m]	PK+ Margin [dB]	Correction [dB]	Polarization	Azimuth [deg]	Antenna Height [m]
5	5,459.500	52.22	74.00	21.78	13.28	V	358.4	1
5	5,460.000	52.17	74.00	21.83	13.28	V	193.4	2
5	5,499.000	106.49			13.30	V	358.4	1

REMARKS:

- Emission Level = Read Level+ Antenna Factor + Cable Loss- Preamp Factor
Margin value = Limit value – Emission Level.
- 5510MHz: Fundamental frequency.
- #: Out of restricted band.



CHANNEL	TX Channel 110	DETECTOR FUNCTION	Peak (PK)
FREQUENCY RANGE	1GHz ~ 40GHz		Average (AV)

ANTENNA POLARITY & TEST DISTANCE: HORIZONTAL AT 3 M

Rg	Frequency [MHz]	AVG Level [dBμV/m]	AVG Limit [dBμV/m]	AVG Margin [dB]	Correction [dB]	Polarization	Azimuth [deg]	Antenna Height [m]
6	5,431.500	36.82	54.00	17.18	13.28	H	301.8	1
6	5,460.000	36.49	54.00	17.51	13.28	H	4.4	1
6	5,547.000	93.31			13.36	H	4.4	1

Rg	Frequency [MHz]	PK+ Level [dBμV/m]	PK+ Limit [dBμV/m]	PK+ Margin [dB]	Correction [dB]	Polarization	Azimuth [deg]	Antenna Height [m]
6	5,458.000	51.17	74.00	22.83	13.28	H	359	1
6	5,460.000	49.72	74.00	24.28	13.28	H	1	1
6	5,546.500	106.50			13.36	H	5	1

ANTENNA POLARITY & TEST DISTANCE: VERTICAL AT 3 M

Rg	Frequency [MHz]	AVG Level [dBμV/m]	AVG Limit [dBμV/m]	AVG Margin [dB]	Correction [dB]	Polarization	Azimuth [deg]	Antenna Height [m]
6	5,455.500	36.52	54.00	17.48	13.28	V	359.1	1
6	5,460.000	36.41	54.00	17.59	13.28	V	358	1
6	5,548.500	93.28			13.35	V	1	1

Rg	Frequency [MHz]	PK+ Level [dBμV/m]	PK+ Limit [dBμV/m]	PK+ Margin [dB]	Correction [dB]	Polarization	Azimuth [deg]	Antenna Height [m]
6	5,430.500	51.12	74.00	22.88	13.28	V	359	2
6	5,460.000	49.41	74.00	24.59	13.28	V	245.9	2
6	5,549.000	106.91			13.35	V	359.1	1

REMARKS:

1. Emission Level = Read Level+ Antenna Factor + Cable Loss- Preamp Factor
Margin value = Limit value – Emission Level.
2. 5500MHz: Fundamental frequency.
3. #: Out of restricted band.



CHANNEL	TX Channel 134	DETECTOR FUNCTION	Peak (PK)
FREQUENCY RANGE	1GHz ~ 40GHz		Average (AV)

ANTENNA POLARITY & TEST DISTANCE: HORIZONTAL AT 3 M

Rg	Frequency [MHz]	PK+ Level [dBμV/m]	PK+ Limit [dBμV/m]	PK+ Margin [dB]	Correction [dB]	Polarization	Azimuth [deg]	Antenna Height [m]
7	5,665.000	103.81			13.81	H	57.9	1
7	5,725.000	50.52	68.20	17.68	14.01	H	1	2
7	5,739.500	51.18	68.20	17.02	14.02	H	132.3	2

ANTENNA POLARITY & TEST DISTANCE: VERTICAL AT 3 M

Rg	Frequency [MHz]	PK+ Level [dBμV/m]	PK+ Limit [dBμV/m]	PK+ Margin [dB]	Correction [dB]	Polarization	Azimuth [deg]	Antenna Height [m]
7	5,668.500	107.18			13.83	V	357.2	1
7	5,725.000	50.24	68.20	17.96	14.01	V	185.8	1
7	5,750.000	51.16	68.20	17.04	14.03	V	353.7	2

REMARKS:

1. Emission Level = Read Level+ Antenna Factor + Cable Loss- Preamp Factor
Margin value = Limit value – Emission Level.
2. 5670MHz: Fundamental frequency.
3. #: Out of restricted band.



CHANNEL	TX Channel 142	DETECTOR FUNCTION	Peak (PK)
FREQUENCY RANGE	1GHz ~ 40GHz		Average (AV)

ANTENNA POLARITY & TEST DISTANCE: HORIZONTAL AT 3 M

Rg	Frequency [MHz]	PK+ Level [dBμV/m]	PK+ Limit [dBμV/m]	PK+ Margin [dB]	Correction [dB]	Polarization	Azimuth [deg]	Antenna Height [m]
8	5,695.500	105.43			13.96	H	62.6	1
8	5,850.000	50.13	68.20	18.07	14.28	H	305.7	2
8	5,865.500	52.04	68.20	16.16	14.36	H	124.9	1

ANTENNA POLARITY & TEST DISTANCE: VERTICAL AT 3 M

Rg	Frequency [MHz]	PK+ Level [dBμV/m]	PK+ Limit [dBμV/m]	PK+ Margin [dB]	Correction [dB]	Polarization	Azimuth [deg]	Antenna Height [m]
8	5,709.000	108.56			14.00	V	1	1
8	5,850.000	50.33	68.20	17.87	14.28	V	359.1	1
8	5,882.500	51.92	68.20	16.28	14.43	V	0.9	2

REMARKS:

- Emission Level = Read Level+ Antenna Factor + Cable Loss- Preamp Factor
Margin value = Limit value – Emission Level.
- 5710MHz: Fundamental frequency.
- #: Out of restricted band.



802.11ax (80MHz)

CHANNEL	TX Channel 106	DETECTOR FUNCTION	Peak (PK)
FREQUENCY RANGE	1GHz ~ 40GHz		Average (AV)

ANTENNA POLARITY & TEST DISTANCE: HORIZONTAL AT 3 M

Rg	Frequency [MHz]	AVG Level [dBµV/m]	AVG Limit [dBµV/m]	AVG Margin [dB]	Correction [dB]	Polarization	Azimuth [deg]	Antenna Height [m]
3	5,450.000	36.50	54.00	17.50	13.28	H	359	1
3	5,460.000	36.66	54.00	17.34	13.28	H	359	1
3	5,519.000	77.79			13.33	H	4.9	1

Rg	Frequency [MHz]	PK+ Level [dBµV/m]	PK+ Limit [dBµV/m]	PK+ Margin [dB]	Correction [dB]	Polarization	Azimuth [deg]	Antenna Height [m]
3	5,458.000	53.06	74.00	20.94	13.28	H	6.4	1
3	5,460.000	51.30	74.00	22.70	13.28	H	6.4	1
3	5,529.000	102.30			13.35	H	6.4	1

ANTENNA POLARITY & TEST DISTANCE: VERTICAL AT 3 M

Rg	Frequency [MHz]	AVG Level [dBµV/m]	AVG Limit [dBµV/m]	AVG Margin [dB]	Correction [dB]	Polarization	Azimuth [deg]	Antenna Height [m]
3	5,450.500	39.43	54.00	14.57	13.28	V	4.3	1
3	5,460.000	40.08	54.00	13.92	13.28	V	359	1
3	5,540.000	87.86			13.36	V	1	1

Rg	Frequency [MHz]	PK+ Level [dBµV/m]	PK+ Limit [dBµV/m]	PK+ Margin [dB]	Correction [dB]	Polarization	Azimuth [deg]	Antenna Height [m]
3	5,451.500	54.09	74.00	19.91	13.28	V	359.1	1
3	5,460.000	53.40	74.00	20.60	13.28	V	357.8	1
3	5,538.500	101.86			13.36	V	1	1

REMARKS:

- Emission Level = Read Level+ Antenna Factor + Cable Loss- Preamp Factor
Margin value = Limit value – Emission Level.
- 5530MHz: Fundamental frequency.
- #: Out of restricted band.



CHANNEL	TX Channel 122	DETECTOR FUNCTION	Peak (PK)
FREQUENCY RANGE	1GHz ~ 40GHz		Average (AV)

ANTENNA POLARITY & TEST DISTANCE: HORIZONTAL AT 3 M

Rg	Frequency [MHz]	PK+ Level [dBµV/m]	PK+ Limit [dBµV/m]	PK+ Margin [dB]	Correction [dB]	Polarization	Azimuth [deg]	Antenna Height [m]
4	5,619.500	99.70			13.56	H	295.8	1
4	5,725.000	49.99	68.20	18.21	14.01	H	355.7	2
4	5,737.000	51.74	68.20	16.46	14.02	H	295.8	1

ANTENNA POLARITY & TEST DISTANCE: VERTICAL AT 3 M

Rg	Frequency [MHz]	PK+ Level [dBµV/m]	PK+ Limit [dBµV/m]	PK+ Margin [dB]	Correction [dB]	Polarization	Azimuth [deg]	Antenna Height [m]
4	5,596.500	101.62			13.44	V	1	1
4	5,725.000	50.54	68.20	17.66	14.01	V	359.1	1
4	5,744.500	51.46	68.20	16.74	14.03	V	1	1

REMARKS:

1. Emission Level = Read Level+ Antenna Factor + Cable Loss- Preamp Factor
Margin value = Limit value – Emission Level.
2. 5610MHz: Fundamental frequency.
3. #: Out of restricted band.



CHANNEL	TX Channel 138	DETECTOR FUNCTION	Peak (PK)
FREQUENCY RANGE	1GHz ~ 40GHz		Average (AV)

ANTENNA POLARITY & TEST DISTANCE: HORIZONTAL AT 3 M

Rg	Frequency [MHz]	PK+ Level [dBμV/m]	PK+ Limit [dBμV/m]	PK+ Margin [dB]	Correction [dB]	Polarization	Azimuth [deg]	Antenna Height [m]
5	5,686.500	100.15			13.92	H	60.3	1
5	5,850.000	50.41	68.20	17.79	14.28	H	299.6	2
5	5,867.500	52.06	68.20	16.14	14.37	H	106	2

ANTENNA POLARITY & TEST DISTANCE: VERTICAL AT 3 M

Rg	Frequency [MHz]	PK+ Level [dBμV/m]	PK+ Limit [dBμV/m]	PK+ Margin [dB]	Correction [dB]	Polarization	Azimuth [deg]	Antenna Height [m]
5	5,689.000	104.25			13.93	V	357.7	1
5	5,850.000	50.74	68.20	17.46	14.28	V	359.1	1
5	5,860.000	51.76	68.20	16.44	14.33	V	359.1	1

REMARKS:

- Emission Level = Read Level+ Antenna Factor + Cable Loss- Preamp Factor
Margin value = Limit value – Emission Level.
- 5690MHz: Fundamental frequency.
- #: Out of restricted band.



802.11a:

Worst case harmonic:

CHANNEL	TX Channel 144	DETECTOR FUNCTION	Peak (PK)
FREQUENCY RANGE	1GHz ~ 40GHz		Average (AV)

ANTENNA POLARITY & TEST DISTANCE: HORIZONTAL AT 3 M

Rg	Frequency [MHz]	PK+ Level [dBμV/m]	PK+ Limit [dBμV/m]	PK+ Margin [dB]	AVG Level [dBμV/m]	AVG Limit [dBμV/m]	AVG Margin [dB]	Correction [dB]	Polarization	Azimuth [deg]	Antenna Height [m]
4	11,440.000	44.95	74.00	29.05	34.60	54.00	19.40	11.84	H	1	2
4	17,160.000	50.92	74.00	23.08	39.84	54.00	14.16	21.43	H	1.4	2

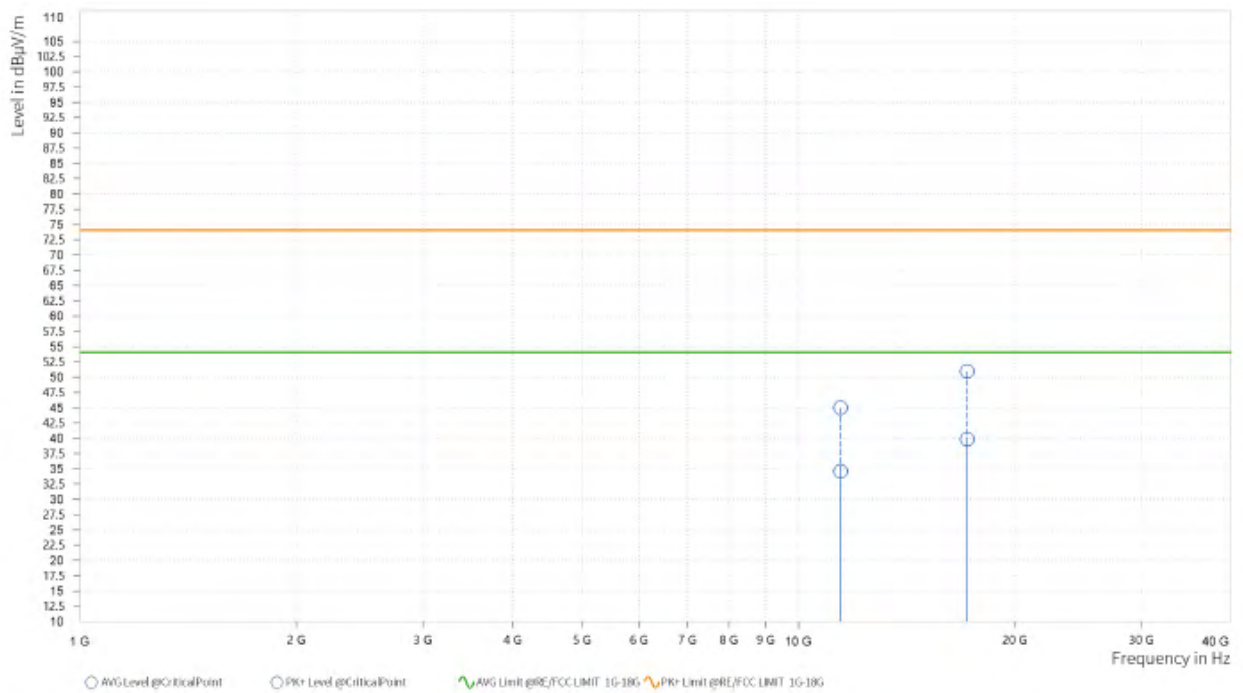



ANTENNA POLARITY & TEST DISTANCE: VERTICAL AT 3 M

Rg	Frequency [MHz]	PK+ Level [dBμV/m]	PK+ Limit [dBμV/m]	PK+ Margin [dB]	AVG Level [dBμV/m]	AVG Limit [dBμV/m]	AVG Margin [dB]	Correction [dB]	Polarization	Azimuth [deg]	Antenna Height [m]
4	11,440.000	45.00	74.00	29.00	34.12	54.00	19.88	11.84	V	358.6	1
4	17,160.000	50.31	74.00	23.69	39.52	54.00	14.48	21.43	V	1.4	2

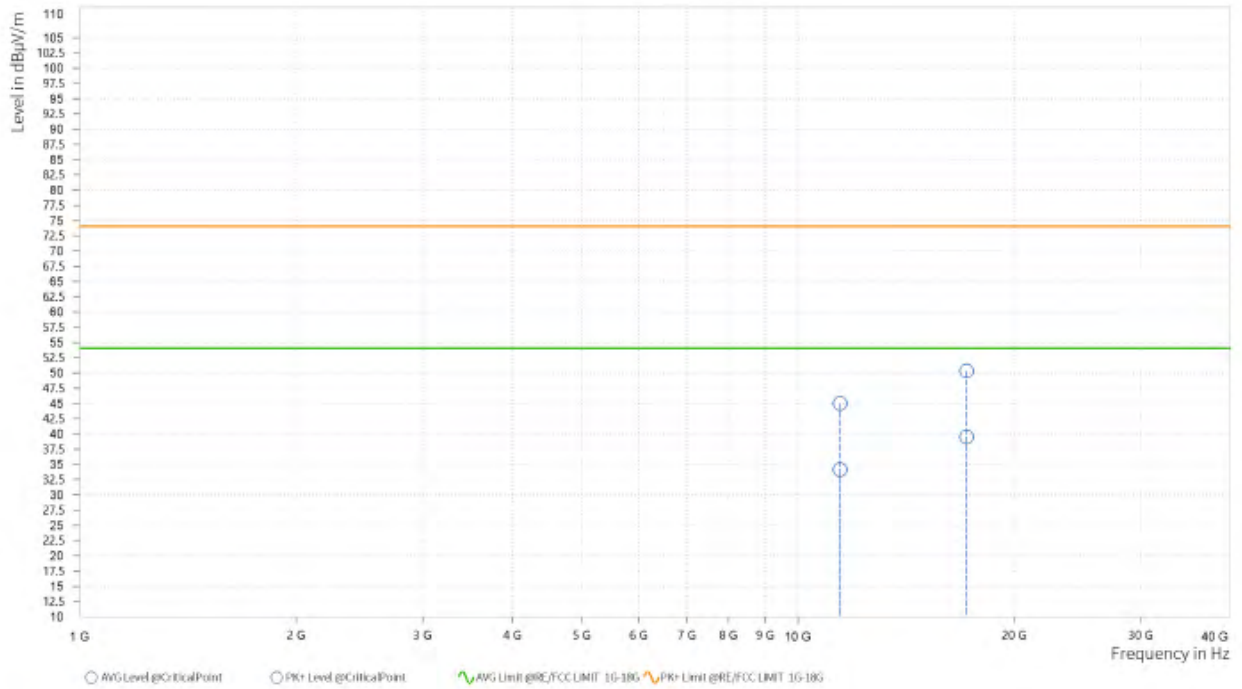

REMARKS:

1. Emission Level = Read Level+ Antenna Factor + Cable Loss- Preamp Factor
Margin value = Limit value – Emission Level.
2. 5720MHz: Fundamental frequency.



5G WIFI-RU

802.11ax (20MHz) (RU26):

CHANNEL	TX Channel 100	DETECTOR FUNCTION	Peak (PK)
FREQUENCY RANGE	1GHz ~ 40GHz		Average (AV)

ANTENNA POLARITY & TEST DISTANCE: HORIZONTAL AT 3 M

Rg	Frequency [MHz]	AVG Level [dBμV/m]	AVG Limit [dBμV/m]	AVG Margin [dB]	Correction [dB]	Polarization	Azimuth [deg]	Antenna Height [m]
7	5,432.500	36.11	54.00	17.89	15.30	H	1	1
7	5,460.000	35.87	54.00	18.13	15.29	H	43.8	1
7	5,491.500	88.07			15.33	H	220.6	2

Rg	Frequency [MHz]	PK+ Level [dBμV/m]	PK+ Limit [dBμV/m]	PK+ Margin [dB]	Correction [dB]	Polarization	Azimuth [deg]	Antenna Height [m]
7	5,432.500	51.37	74.00	22.63	15.30	H	355	2
7	5,460.000	50.10	74.00	23.90	15.29	H	2.9	2
7	5,492.000	100.09			15.34	H	220.7	2

ANTENNA POLARITY & TEST DISTANCE: VERTICAL AT 3 M

Rg	Frequency [MHz]	AVG Level [dBμV/m]	AVG Limit [dBμV/m]	AVG Margin [dB]	Correction [dB]	Polarization	Azimuth [deg]	Antenna Height [m]
7	5,433.500	36.15	54.00	17.85	15.30	V	1	1
7	5,460.000	35.90	54.00	18.10	15.29	V	5.1	1
7	5,491.500	85.54			15.33	V	315.1	2

Rg	Frequency [MHz]	PK+ Level [dBμV/m]	PK+ Limit [dBμV/m]	PK+ Margin [dB]	Correction [dB]	Polarization	Azimuth [deg]	Antenna Height [m]
7	5,443.500	51.36	74.00	22.64	15.30	V	5.2	1
7	5,460.000	50.32	74.00	23.68	15.29	V	355.5	2
7	5,492.000	98.50			15.34	V	316.3	2

REMARKS:

- Emission Level = Read Level+ Antenna Factor + Cable Loss- Preamp Factor
Margin value = Limit value – Emission Level.
- 5500MHz: Fundamental frequency.
- #: Out of restricted band.



802.11ax (20MHz) (RU26):

CHANNEL	TX Channel 116	DETECTOR FUNCTION	Peak (PK)
FREQUENCY RANGE	1GHz ~ 40GHz		Average (AV)

ANTENNA POLARITY & TEST DISTANCE: HORIZONTAL AT 3 M

Rg	Frequency [MHz]	AVG Level [dBμV/m]	AVG Limit [dBμV/m]	AVG Margin [dB]	Correction [dB]	Polarization	Azimuth [deg]	Antenna Height [m]
8	5,432.000	36.18	54.00	17.82	15.30	H	297.2	1
8	5,460.000	35.95	54.00	18.05	15.29	H	1	1
8	5,579.500	88.58			15.69	H	243.4	2

Rg	Frequency [MHz]	PK+ Level [dBμV/m]	PK+ Limit [dBμV/m]	PK+ Margin [dB]	Correction [dB]	Polarization	Azimuth [deg]	Antenna Height [m]
8	5,440.500	50.96	74.00	23.04	15.30	H	123.8	2
8	5,460.000	50.13	74.00	23.87	15.29	H	268.5	2
8	5,579.500	98.33			15.69	H	140.6	1

ANTENNA POLARITY & TEST DISTANCE: VERTICAL AT 3 M

Rg	Frequency [MHz]	AVG Level [dBμV/m]	AVG Limit [dBμV/m]	AVG Margin [dB]	Correction [dB]	Polarization	Azimuth [deg]	Antenna Height [m]
8	5,432.000	36.16	54.00	17.84	15.30	V	303.2	2
8	5,460.000	35.94	54.00	18.06	15.29	V	4.5	1
8	5,579.500	85.43			15.69	V	242.2	2

Rg	Frequency [MHz]	PK+ Level [dBμV/m]	PK+ Limit [dBμV/m]	PK+ Margin [dB]	Correction [dB]	Polarization	Azimuth [deg]	Antenna Height [m]
8	5,449.000	51.05	74.00	22.95	15.30	V	5.2	1
8	5,460.000	49.86	74.00	24.14	15.29	V	317.5	2
8	5,581.000	95.50			15.70	V	91.7	1

REMARKS:

- Emission Level = Read Level+ Antenna Factor + Cable Loss- Preamp Factor
Margin value = Limit value – Emission Level.
- 5580MHz: Fundamental frequency.
- #: Out of restricted band.



CHANNEL	TX Channel 140	DETECTOR FUNCTION	Peak (PK)
FREQUENCY RANGE	1GHz ~ 40GHz		Average (AV)

ANTENNA POLARITY & TEST DISTANCE: HORIZONTAL AT 3 M

Rg	Frequency [MHz]	PK+ Level [dBμV/m]	PK+ Limit [dBμV/m]	PK+ Margin [dB]	Correction [dB]	Polarization	Azimuth [deg]	Antenna Height [m]
9	5,708.500	97.51			16.47	H	77.2	2
9	5,725.000	51.32	68.20	16.88	16.42	H	91.7	1
9	5,744.500	51.89	68.20	16.31	16.37	H	30.6	2

ANTENNA POLARITY & TEST DISTANCE: VERTICAL AT 3 M

Rg	Frequency [MHz]	PK+ Level [dBμV/m]	PK+ Limit [dBμV/m]	PK+ Margin [dB]	Correction [dB]	Polarization	Azimuth [deg]	Antenna Height [m]
9	5,708.500	98.56			16.47	V	223.1	2
9	5,725.000	50.79	68.20	17.41	16.42	V	270.9	2
9	5,749.000	52.06	68.20	16.14	16.36	V	232.7	1

REMARKS:

- Emission Level = Read Level+ Antenna Factor + Cable Loss- Preamp Factor
Margin value = Limit value – Emission Level.
- 5700MHz: Fundamental frequency.
- #: Out of restricted band.



CHANNEL	TX Channel 144	DETECTOR FUNCTION	Peak (PK)
FREQUENCY RANGE	1GHz ~ 40GHz		Average (AV)

ANTENNA POLARITY & TEST DISTANCE: HORIZONTAL AT 3 M

Rg	Frequency [MHz]	PK+ Level [dBμV/m]	PK+ Limit [dBμV/m]	PK+ Margin [dB]	Correction [dB]	Polarization	Azimuth [deg]	Antenna Height [m]
10	5,728.000	100.48			16.42	H	269.7	2
10	5,850.000	50.85	68.20	17.35	16.64	H	0.9	2
10	5,878.500	52.54	68.20	15.66	16.96	H	1	1

ANTENNA POLARITY & TEST DISTANCE: VERTICAL AT 3 M

Rg	Frequency [MHz]	PK+ Level [dBμV/m]	PK+ Limit [dBμV/m]	PK+ Margin [dB]	Correction [dB]	Polarization	Azimuth [deg]	Antenna Height [m]
10	5,728.000	100.17			16.42	V	282.9	1
10	5,850.000	50.31	68.20	17.89	16.64	V	282.9	1
10	5,883.500	52.64	68.20	15.56	16.93	V	126.2	2

REMARKS:

- Emission Level = Read Level+ Antenna Factor + Cable Loss- Preamp Factor
Margin value = Limit value – Emission Level.
- 5720MHz: Fundamental frequency.
- #: Out of restricted band.



Band 4:

802.11a

ANTENNA POLARITY & TEST DISTANCE: HORIZONTAL AT 3 M

Rg	Frequency [MHz]	PK+ Level [dBμV/m]	PK+ Limit [dBμV/m]	PK+ Margin [dB]	Correction [dB]	Polarization	Azimuth [deg]	Antenna Height [m]
12	5,646.250	50.35	68.20	17.85	13.72	H	353	1
13	5,746.250	107.92			14.03	H	85.4	1
14	5,971.875	51.83	68.20	16.37	14.57	H	359.1	1

ANTENNA POLARITY & TEST DISTANCE: VERTICAL AT 3 M

Rg	Frequency [MHz]	PK+ Level [dBμV/m]	PK+ Limit [dBμV/m]	PK+ Margin [dB]	Correction [dB]	Polarization	Azimuth [deg]	Antenna Height [m]
12	5,647.500	52.30	68.20	15.90	13.72	V	359.1	1
12	5,739.000	111.31			14.02	V	359.1	1
12	5,950.500	53.00	68.20	15.20	14.50	V	359	2

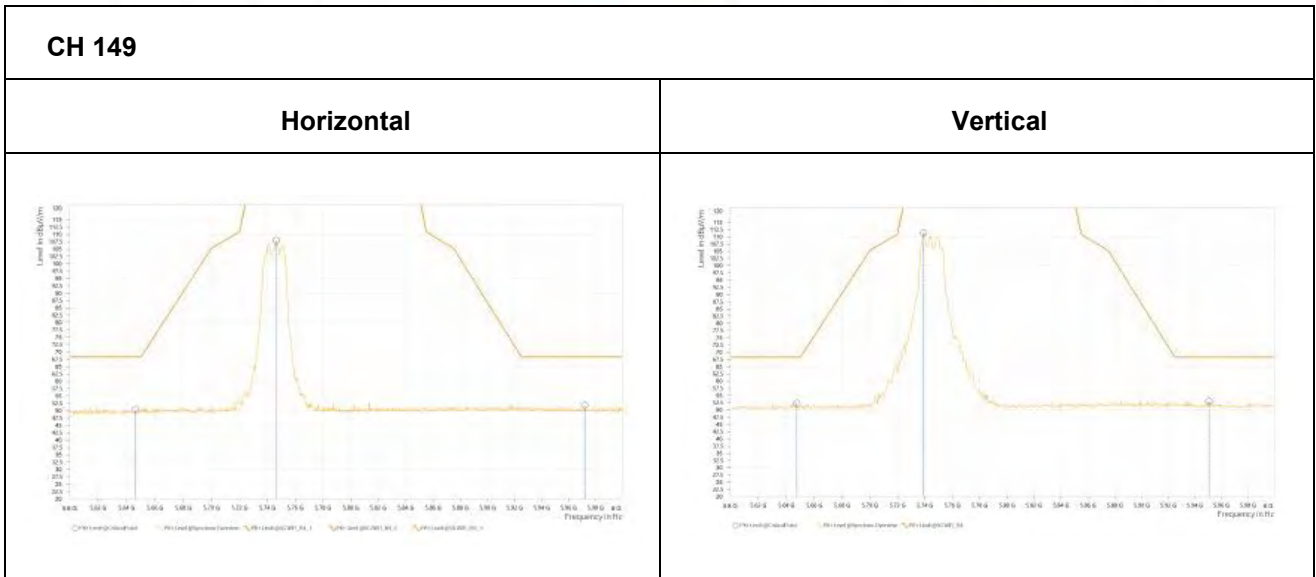



ANTENNA POLARITY & TEST DISTANCE: HORIZONTAL AT 3 M

Rg	Frequency [MHz]	PK+ Level [dBμV/m]	PK+ Limit [dBμV/m]	PK+ Margin [dB]	Correction [dB]	Polarization	Azimuth [deg]	Antenna Height [m]
12	5,638.750	50.76	68.20	17.44	13.67	H	5	1
13	5,786.560	106.95			14.16	H	264.7	1
14	5,957.625	51.55	68.20	16.65	14.52	H	1	1

ANTENNA POLARITY & TEST DISTANCE: VERTICAL AT 3 M

Rg	Frequency [MHz]	PK+ Level [dBμV/m]	PK+ Limit [dBμV/m]	PK+ Margin [dB]	Correction [dB]	Polarization	Azimuth [deg]	Antenna Height [m]
12	5,629.000	52.39	68.20	15.81	13.62	V	1	1
12	5,789.500	110.66			14.17	V	1	1
12	5,984.000	52.81	68.20	15.39	14.61	V	303.3	2

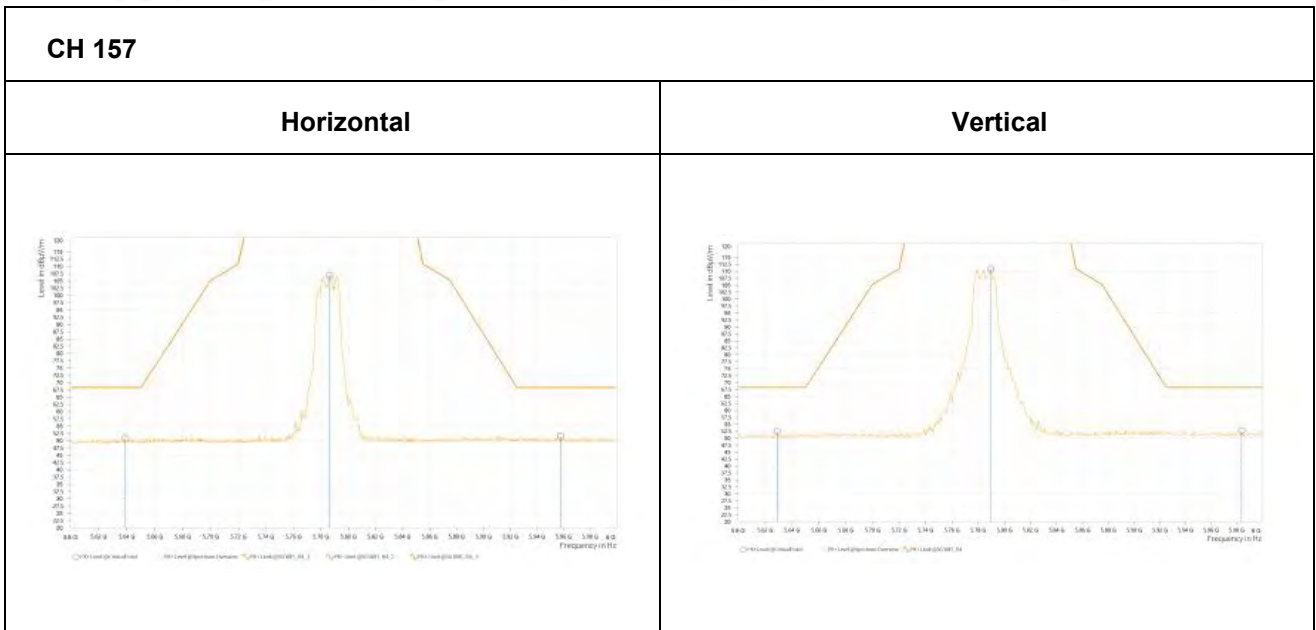



802.11a

ANTENNA POLARITY & TEST DISTANCE: HORIZONTAL AT 3 M

Rg	Frequency [MHz]	PK+ Level [dBμV/m]	PK+ Limit [dBμV/m]	PK+ Margin [dB]	Correction [dB]	Polarization	Azimuth [deg]	Antenna Height [m]
12	5,643.438	51.54	68.20	16.66	13.70	H	355	2
13	5,827.188	107.81			14.25	H	261.1	1
14	5,954.625	51.58	68.20	16.62	14.51	H	359.1	1

ANTENNA POLARITY & TEST DISTANCE: VERTICAL AT 3 M

Rg	Frequency [MHz]	PK+ Level [dBμV/m]	PK+ Limit [dBμV/m]	PK+ Margin [dB]	Correction [dB]	Polarization	Azimuth [deg]	Antenna Height [m]
12	5,641.500	52.10	68.20	16.10	13.69	V	359.1	1
12	5,819.000	110.66			14.25	V	1	1
12	5,937.500	53.10	68.20	15.10	14.48	V	359.1	1

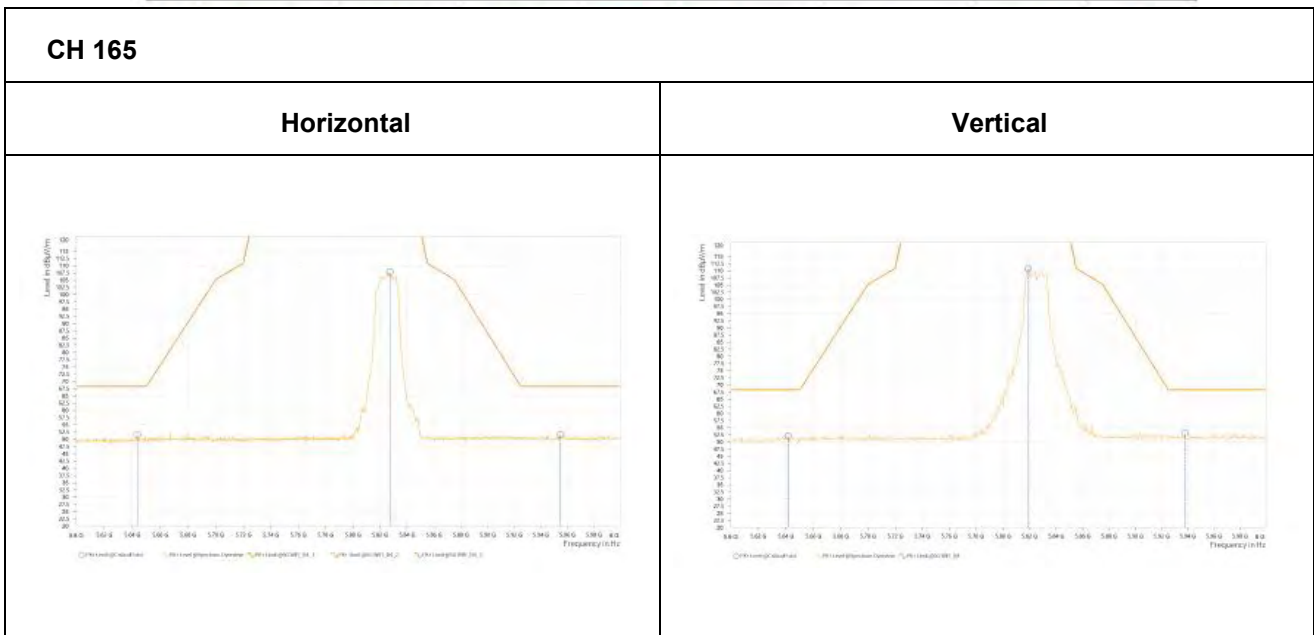



802.11n (20MHz)

ANTENNA POLARITY & TEST DISTANCE: HORIZONTAL AT 3 M

Rg	Frequency [MHz]	PK+ Level [dBμV/m]	PK+ Limit [dBμV/m]	PK+ Margin [dB]	Correction [dB]	Polarization	Azimuth [deg]	Antenna Height [m]
12	5,648.438	51.23	68.20	16.97	13.73	H	5	1
13	5,746.880	106.01			14.03	H	85.4	1
14	5,950.500	51.36	68.20	16.84	14.50	H	189.7	2

ANTENNA POLARITY & TEST DISTANCE: VERTICAL AT 3 M

Rg	Frequency [MHz]	PK+ Level [dBμV/m]	PK+ Limit [dBμV/m]	PK+ Margin [dB]	Correction [dB]	Polarization	Azimuth [deg]	Antenna Height [m]
12	5,639.000	51.85	68.20	16.35	13.67	V	359	2
12	5,743.000	110.91			14.03	V	359.1	1
12	5,934.000	54.01	68.20	14.19	14.48	V	1	1

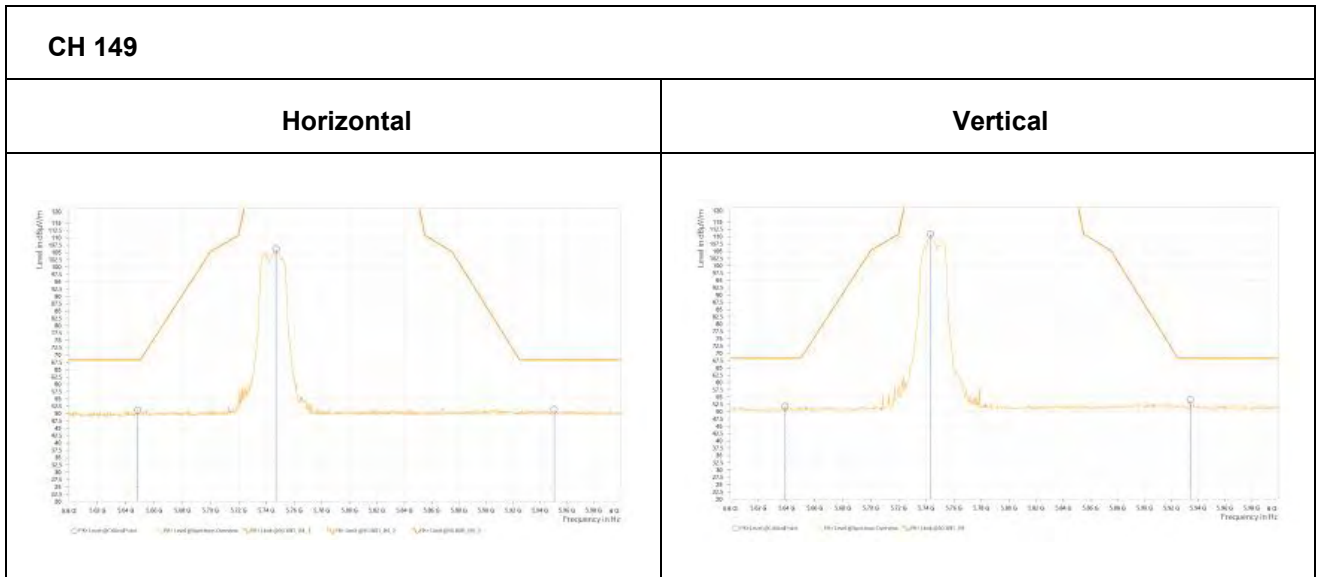



ANTENNA POLARITY & TEST DISTANCE: HORIZONTAL AT 3 M

Rg	Frequency [MHz]	PK+ Level [dBμV/m]	PK+ Limit [dBμV/m]	PK+ Margin [dB]	Correction [dB]	Polarization	Azimuth [deg]	Antenna Height [m]
12	5,644.688	50.75	68.20	17.45	13.71	H	4.9	1
13	5,787.810	107.39			14.17	H	265.9	1
14	5,956.125	51.84	68.20	16.36	14.52	H	1	1

ANTENNA POLARITY & TEST DISTANCE: VERTICAL AT 3 M

Rg	Frequency [MHz]	PK+ Level [dBμV/m]	PK+ Limit [dBμV/m]	PK+ Margin [dB]	Correction [dB]	Polarization	Azimuth [deg]	Antenna Height [m]
12	5,608.500	51.94	68.20	16.26	13.50	V	359.1	1
12	5,783.500	111.17			14.15	V	359.1	1
12	5,926.500	53.06	68.20	15.14	14.48	V	11.5	1

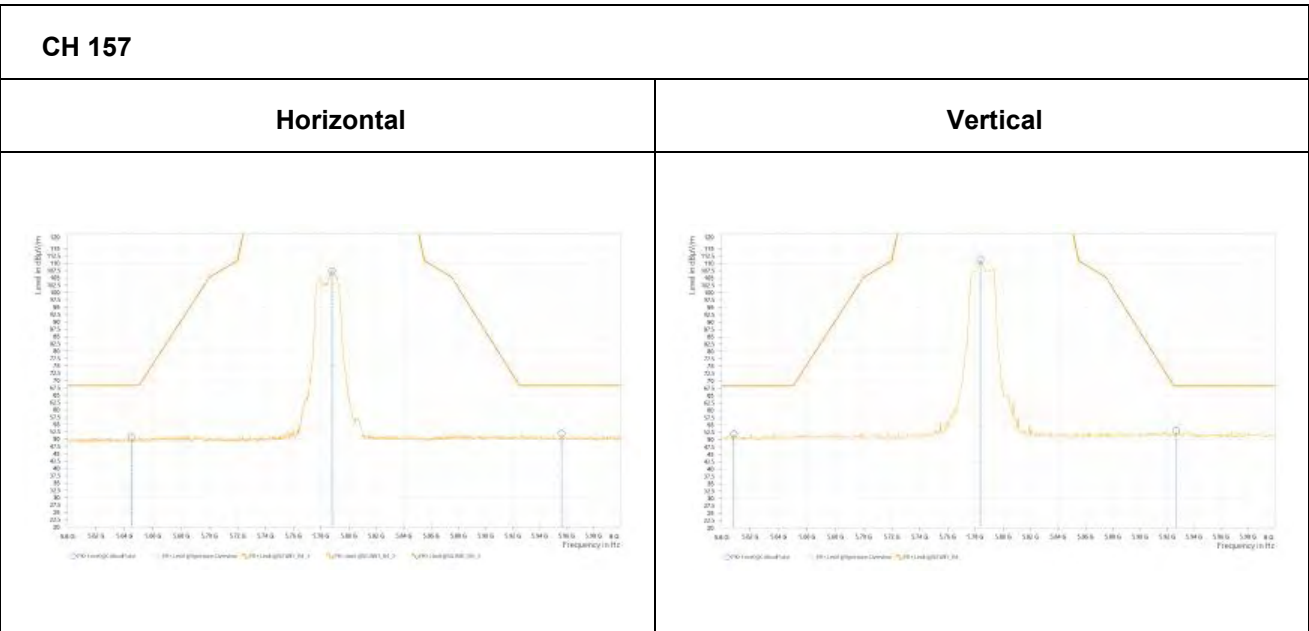



ANTENNA POLARITY & TEST DISTANCE: HORIZONTAL AT 3 M

Rg	Frequency [MHz]	PK+ Level [dBμV/m]	PK+ Limit [dBμV/m]	PK+ Margin [dB]	Correction [dB]	Polarization	Azimuth [deg]	Antenna Height [m]
12	5,647.000	51.08	68.20	17.12	13.72	H	303.3	2
12	5,825.500	106.99			14.25	H	58.2	2
12	5,999.500	52.48	68.20	15.72	14.68	H	242.3	2

ANTENNA POLARITY & TEST DISTANCE: VERTICAL AT 3 M

Rg	Frequency [MHz]	PK+ Level [dBμV/m]	PK+ Limit [dBμV/m]	PK+ Margin [dB]	Correction [dB]	Polarization	Azimuth [deg]	Antenna Height [m]
12	5,603.500	52.15	68.20	16.05	13.47	V	359	1
12	5,823.500	110.09			14.25	V	359	1
12	5,955.000	53.53	68.20	14.67	14.51	V	5.4	2

CH 165

Horizontal

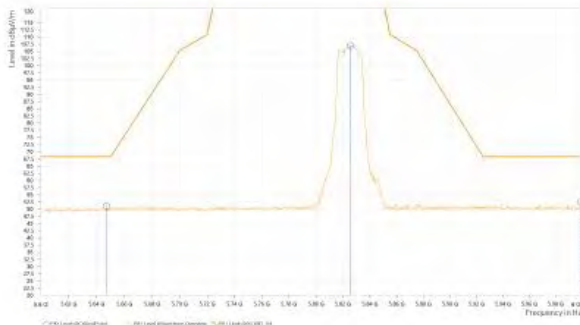

Vertical

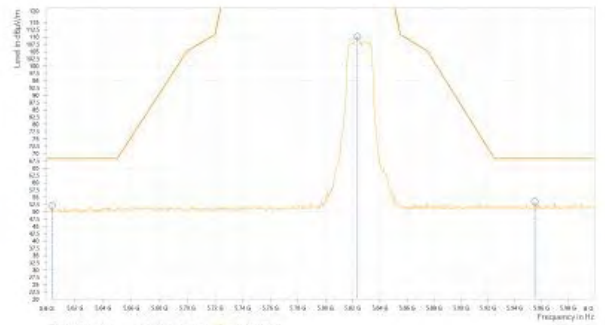



802.11n (40MHz)

ANTENNA POLARITY & TEST DISTANCE: HORIZONTAL AT 3 M

Rg	Frequency [MHz]	PK+ Level [dBμV/m]	PK+ Limit [dBμV/m]	PK+ Margin [dB]	Correction [dB]	Polarization	Azimuth [deg]	Antenna Height [m]
12	5,643.750	51.24	68.20	16.96	13.70	H	4.9	1
13	5,747.810	103.88			14.03	H	86.5	1
14	5,989.125	51.84	68.20	16.36	14.62	H	46.3	2

ANTENNA POLARITY & TEST DISTANCE: VERTICAL AT 3 M

Rg	Frequency [MHz]	PK+ Level [dBμV/m]	PK+ Limit [dBμV/m]	PK+ Margin [dB]	Correction [dB]	Polarization	Azimuth [deg]	Antenna Height [m]
9	5,639.500	53.18	68.20	15.02	13.68	V	359.1	1
9	5,762.000	107.75			14.07	V	359.1	1
9	5,999.500	54.80	68.20	13.40	14.68	V	56.6	1

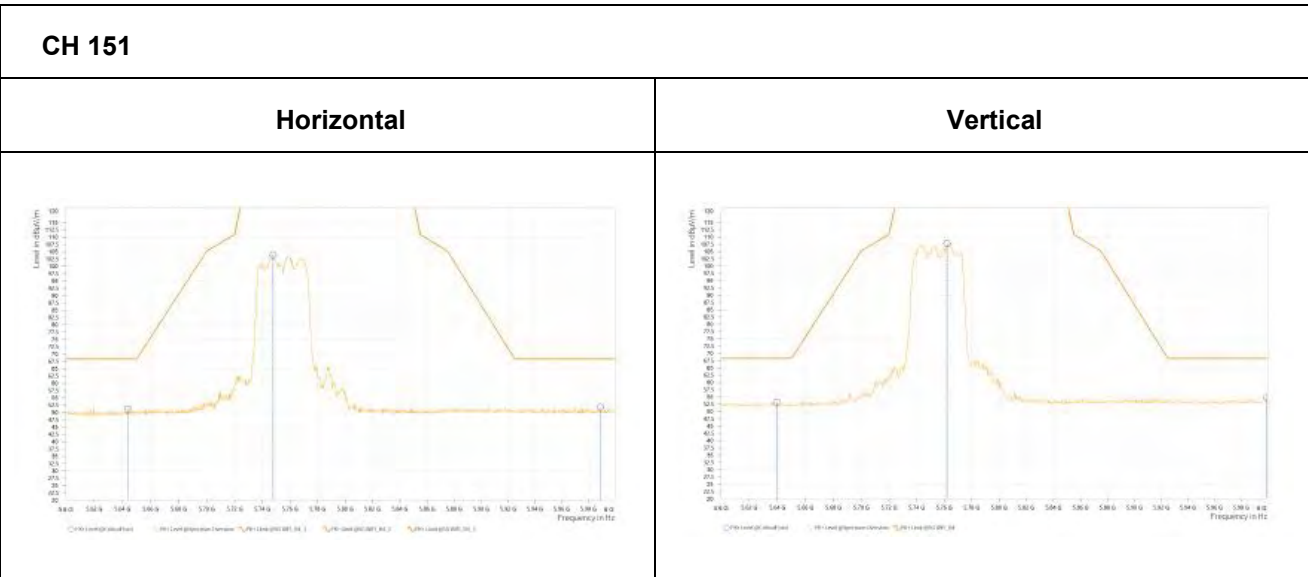



ANTENNA POLARITY & TEST DISTANCE: HORIZONTAL AT 3 M

Rg	Frequency [MHz]	PK+ Level [dBμV/m]	PK+ Limit [dBμV/m]	PK+ Margin [dB]	Correction [dB]	Polarization	Azimuth [deg]	Antenna Height [m]
12	5,644.375	50.71	68.20	17.49	13.70	H	139.5	2
13	5,788.130	105.04			14.17	H	265.8	1
14	5,941.875	51.58	68.20	16.62	14.49	H	359.1	1

ANTENNA POLARITY & TEST DISTANCE: VERTICAL AT 3 M

Rg	Frequency [MHz]	PK+ Level [dBμV/m]	PK+ Limit [dBμV/m]	PK+ Margin [dB]	Correction [dB]	Polarization	Azimuth [deg]	Antenna Height [m]
9	5,631.500	53.47	68.20	14.73	13.63	V	1.3	2
9	5,804.000	107.75			14.22	V	359.1	1
9	5,970.000	54.38	68.20	13.82	14.56	V	0.8	2

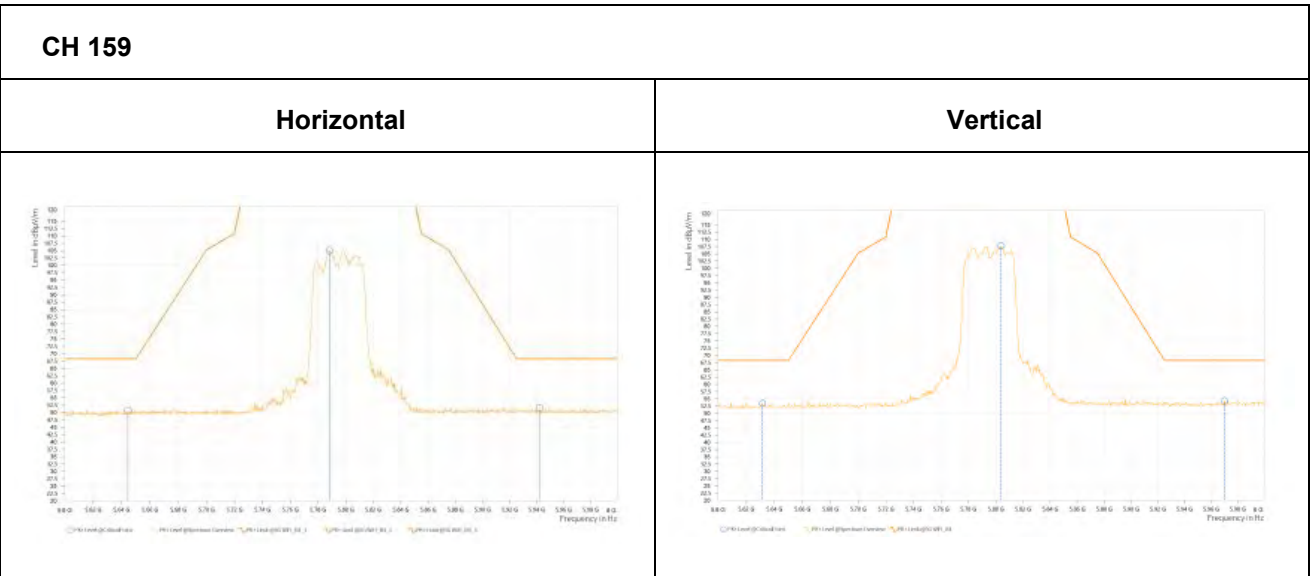



802.11ac (20MHz)

ANTENNA POLARITY & TEST DISTANCE: HORIZONTAL AT 3 M

Rg	Frequency [MHz]	PK+ Level [dBμV/m]	PK+ Limit [dBμV/m]	PK+ Margin [dB]	Correction [dB]	Polarization	Azimuth [deg]	Antenna Height [m]
12	5,641.875	51.74	68.20	16.46	13.69	H	353	1
13	5,747.810	106.68			14.03	H	85.3	1
14	5,936.625	51.47	68.20	16.73	14.48	H	311.2	1

ANTENNA POLARITY & TEST DISTANCE: VERTICAL AT 3 M

Rg	Frequency [MHz]	PK+ Level [dBμV/m]	PK+ Limit [dBμV/m]	PK+ Margin [dB]	Correction [dB]	Polarization	Azimuth [deg]	Antenna Height [m]
12	5,641.000	52.08	68.20	16.12	13.69	V	1	1
12	5,743.000	110.35			14.03	V	355.4	1
12	5,996.000	53.07	68.20	15.13	14.65	V	6.2	2

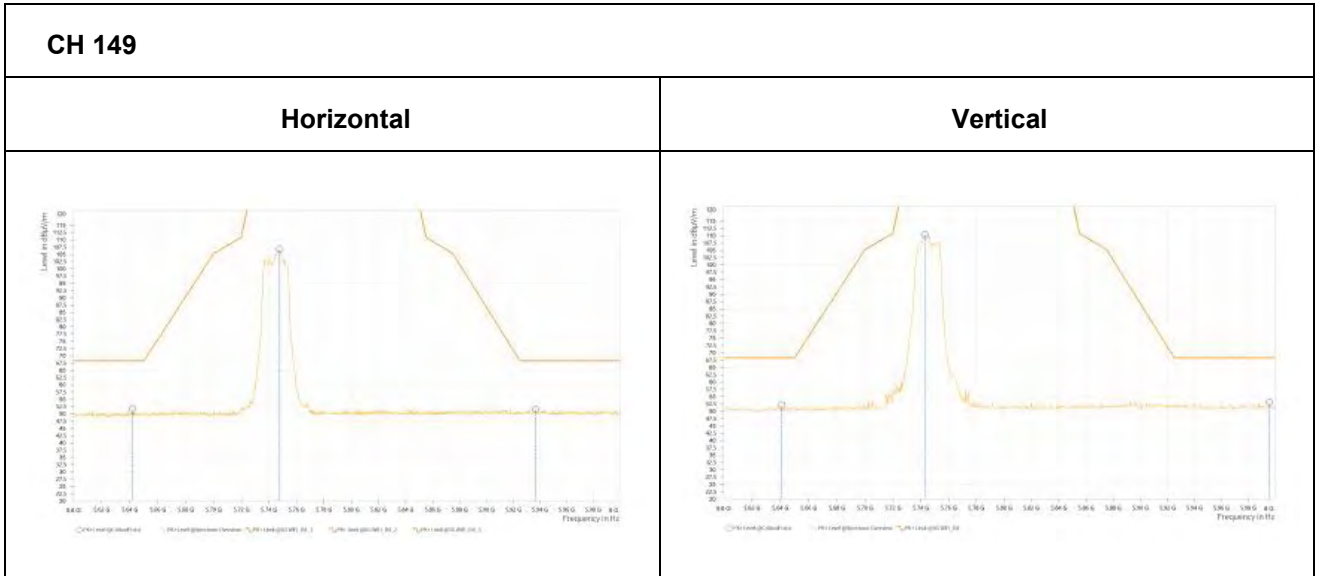



ANTENNA POLARITY & TEST DISTANCE: HORIZONTAL AT 3 M

Rg	Frequency [MHz]	PK+ Level [dBμV/m]	PK+ Limit [dBμV/m]	PK+ Margin [dB]	Correction [dB]	Polarization	Azimuth [deg]	Antenna Height [m]
12	5,641.875	50.97	68.20	17.23	13.69	H	5.4	2
13	5,788.130	106.53			14.17	H	268.2	1
14	5,939.625	51.10	68.20	17.10	14.49	H	46.3	2

ANTENNA POLARITY & TEST DISTANCE: VERTICAL AT 3 M

Rg	Frequency [MHz]	PK+ Level [dBμV/m]	PK+ Limit [dBμV/m]	PK+ Margin [dB]	Correction [dB]	Polarization	Azimuth [deg]	Antenna Height [m]
12	5,622.500	52.23	68.20	15.97	13.58	V	359.1	1
12	5,784.000	110.64			14.15	V	1	1
12	5,932.000	53.19	68.20	15.01	14.48	V	3.5	2

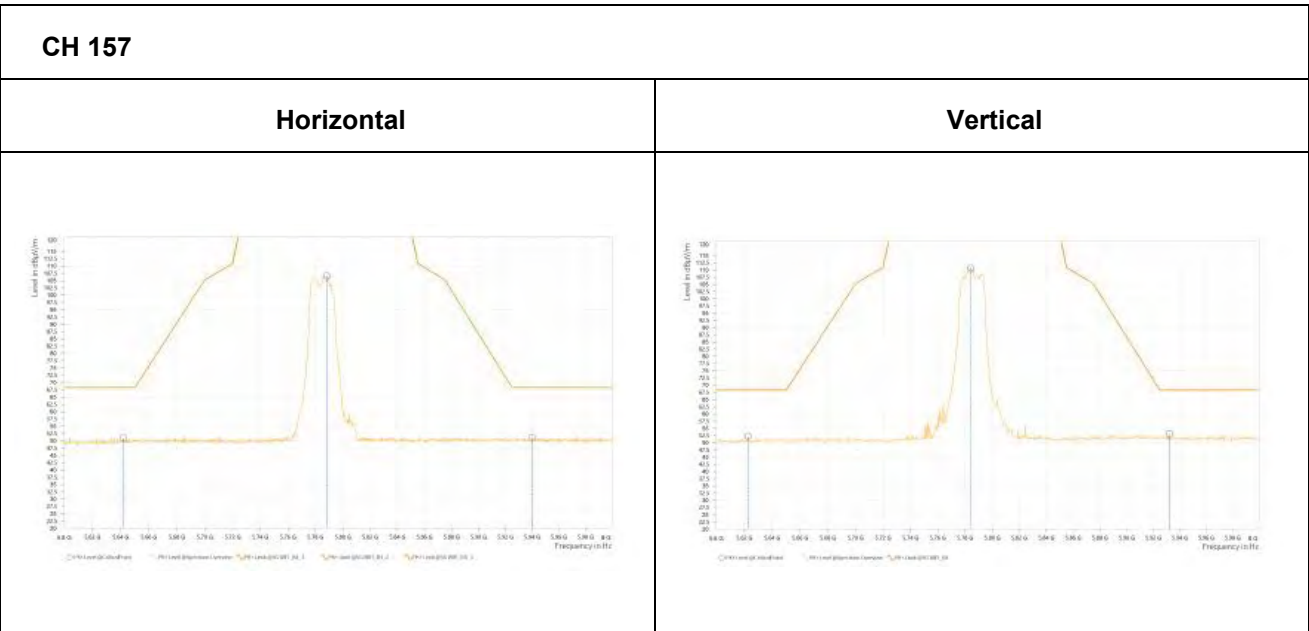



ANTENNA POLARITY & TEST DISTANCE: HORIZONTAL AT 3 M

Rg	Frequency [MHz]	PK+ Level [dBμV/m]	PK+ Limit [dBμV/m]	PK+ Margin [dB]	Correction [dB]	Polarization	Azimuth [deg]	Antenna Height [m]
12	5,642.813	50.86	68.20	17.34	13.70	H	359	2
13	5,821.560	107.87			14.25	H	277.8	1
14	5,952.375	51.91	68.20	16.29	14.50	H	325.7	1

ANTENNA POLARITY & TEST DISTANCE: VERTICAL AT 3 M

Rg	Frequency [MHz]	PK+ Level [dBμV/m]	PK+ Limit [dBμV/m]	PK+ Margin [dB]	Correction [dB]	Polarization	Azimuth [deg]	Antenna Height [m]
12	5,603.500	52.05	68.20	16.15	13.47	V	12.2	2
12	5,822.500	110.17			14.25	V	1	1
12	5,989.000	53.61	68.20	14.59	14.62	V	359.1	1

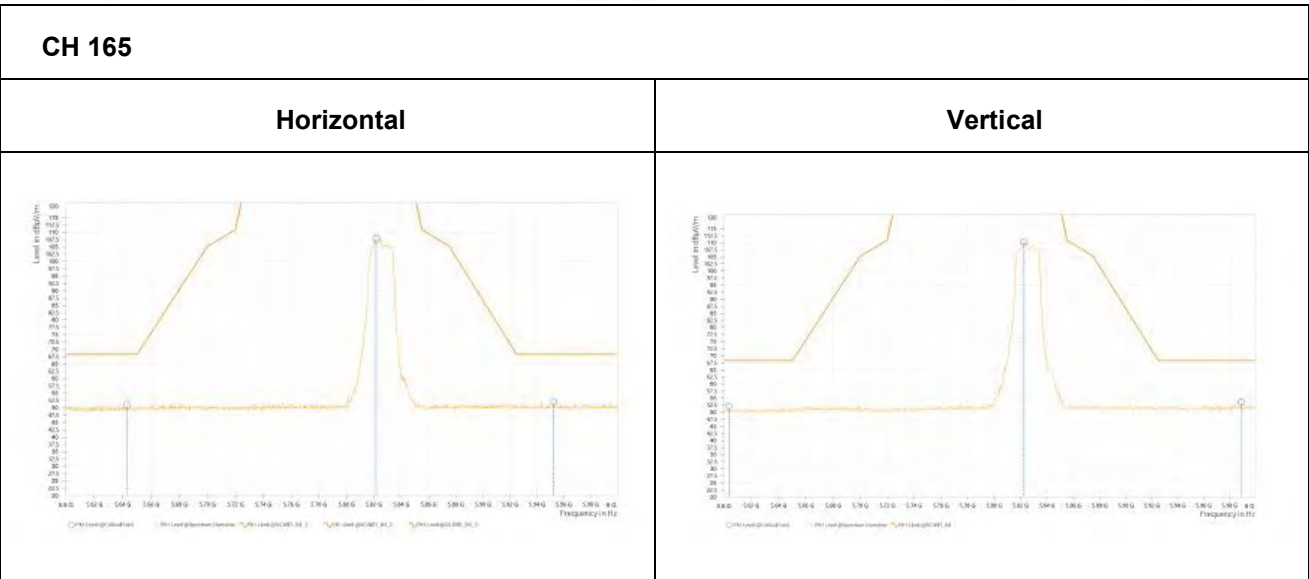



802.11ac (40MHz)

ANTENNA POLARITY & TEST DISTANCE: HORIZONTAL AT 3 M

Rg	Frequency [MHz]	PK+ Level [dBμV/m]	PK+ Limit [dBμV/m]	PK+ Margin [dB]	Correction [dB]	Polarization	Azimuth [deg]	Antenna Height [m]
12	5,631.875	51.56	68.20	16.64	13.63	H	5.7	1
13	5,758.130	102.36			14.06	H	87.8	1
14	5,951.625	51.46	68.20	16.74	14.50	H	359.1	1

ANTENNA POLARITY & TEST DISTANCE: VERTICAL AT 3 M

Rg	Frequency [MHz]	PK+ Level [dBμV/m]	PK+ Limit [dBμV/m]	PK+ Margin [dB]	Correction [dB]	Polarization	Azimuth [deg]	Antenna Height [m]
12	5,607.188	51.34	68.20	16.86	13.50	V	5	1
13	5,743.125	106.74			14.03	V	1	1
14	5,925.750	51.68	68.20	16.52	14.48	V	359.1	1

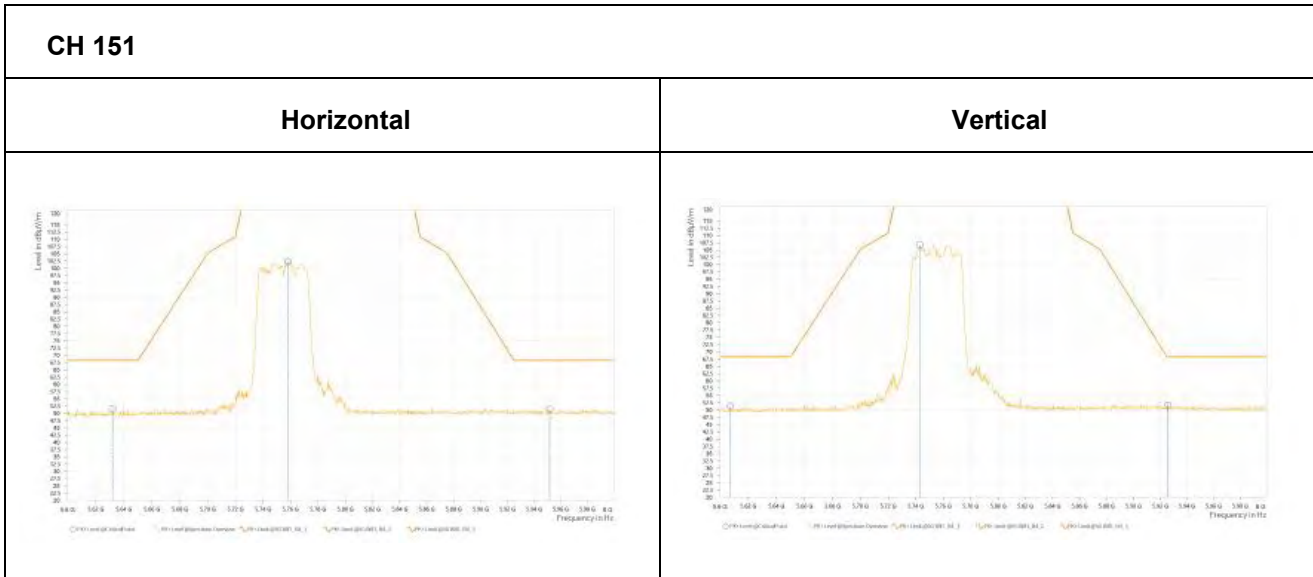



ANTENNA POLARITY & TEST DISTANCE: HORIZONTAL AT 3 M

Rg	Frequency [MHz]	PK+ Level [dBμV/m]	PK+ Limit [dBμV/m]	PK+ Margin [dB]	Correction [dB]	Polarization	Azimuth [deg]	Antenna Height [m]
12	5,634.375	50.85	68.20	17.35	13.65	H	5.6	1
13	5,787.190	104.58			14.16	H	267.1	1
14	5,935.125	51.64	68.20	16.56	14.48	H	188.6	2

ANTENNA POLARITY & TEST DISTANCE: VERTICAL AT 3 M

Rg	Frequency [MHz]	PK+ Level [dBμV/m]	PK+ Limit [dBμV/m]	PK+ Margin [dB]	Correction [dB]	Polarization	Azimuth [deg]	Antenna Height [m]
12	5,637.500	51.58	68.20	16.62	13.67	V	1	1
13	5,802.190	106.98			14.22	V	359.1	1
14	5,930.250	51.88	68.20	16.32	14.48	V	171.4	1

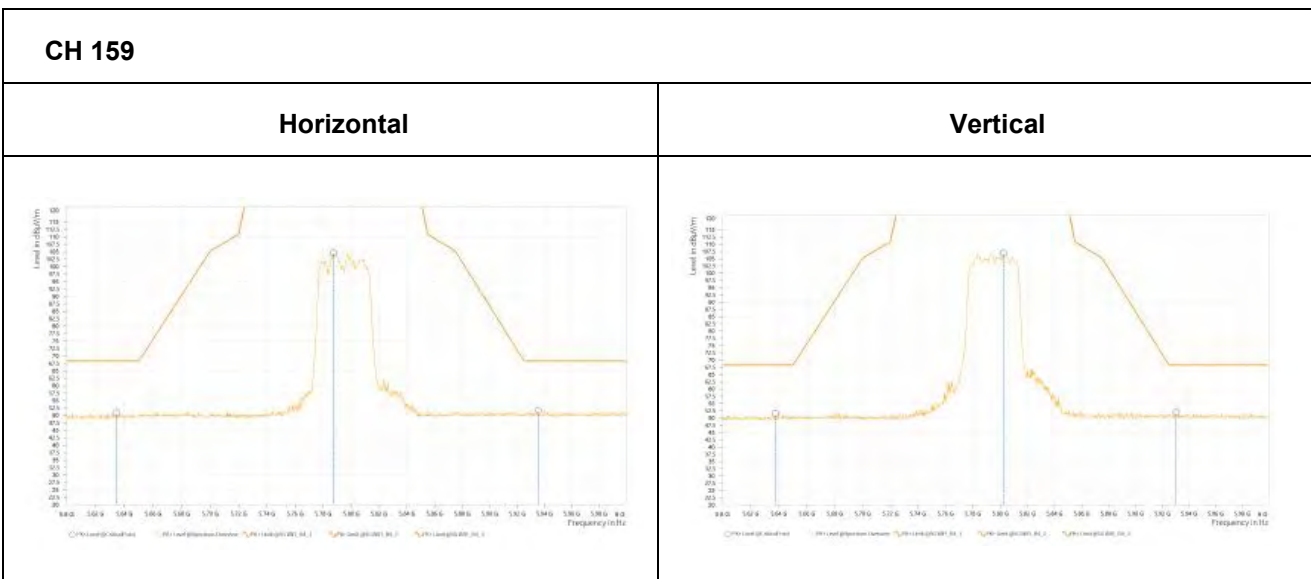



802.11ac (80MHz)

ANTENNA POLARITY & TEST DISTANCE: HORIZONTAL AT 3 M

Rg	Frequency [MHz]	PK+ Level [dBμV/m]	PK+ Limit [dBμV/m]	PK+ Margin [dB]	Correction [dB]	Polarization	Azimuth [deg]	Antenna Height [m]
6	5,638.125	50.98	68.20	17.22	13.67	H	7.4	2
7	5,790.940	101.41			14.18	H	265.9	1
8	5,939.250	51.93	68.20	16.27	14.48	H	192.2	2

ANTENNA POLARITY & TEST DISTANCE: VERTICAL AT 3 M

Rg	Frequency [MHz]	PK+ Level [dBμV/m]	PK+ Limit [dBμV/m]	PK+ Margin [dB]	Correction [dB]	Polarization	Azimuth [deg]	Antenna Height [m]
6	5,633.750	51.10	68.20	17.10	13.65	V	359.1	1
7	5,795.313	103.92			14.19	V	359	1
8	5,965.875	52.01	68.20	16.19	14.55	V	359.1	1

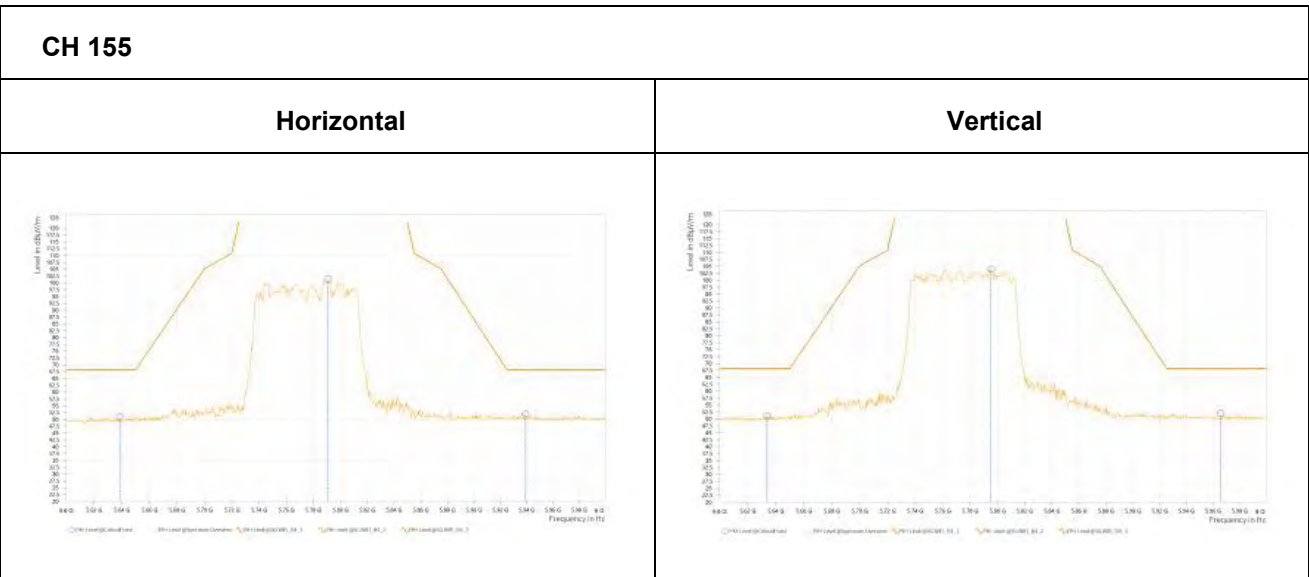



802.11ax (20MHz)

ANTENNA POLARITY & TEST DISTANCE: HORIZONTAL AT 3 M

Rg	Frequency [MHz]	PK+ Level [dBμV/m]	PK+ Limit [dBμV/m]	PK+ Margin [dB]	Correction [dB]	Polarization	Azimuth [deg]	Antenna Height [m]
12	5,627.000	51.31	68.20	16.89	13.61	H	57	2
12	5,750.500	107.57			14.03	H	308.9	1
12	5,987.000	51.54	68.20	16.66	14.62	H	57	2

ANTENNA POLARITY & TEST DISTANCE: VERTICAL AT 3 M

Rg	Frequency [MHz]	PK+ Level [dBμV/m]	PK+ Limit [dBμV/m]	PK+ Margin [dB]	Correction [dB]	Polarization	Azimuth [deg]	Antenna Height [m]
12	5,627.000	51.75	68.20	16.45	13.61	V	65	1
12	5,742.000	111.66			14.03	V	344.5	1
12	5,941.000	53.18	68.20	15.02	14.49	V	2.3	2

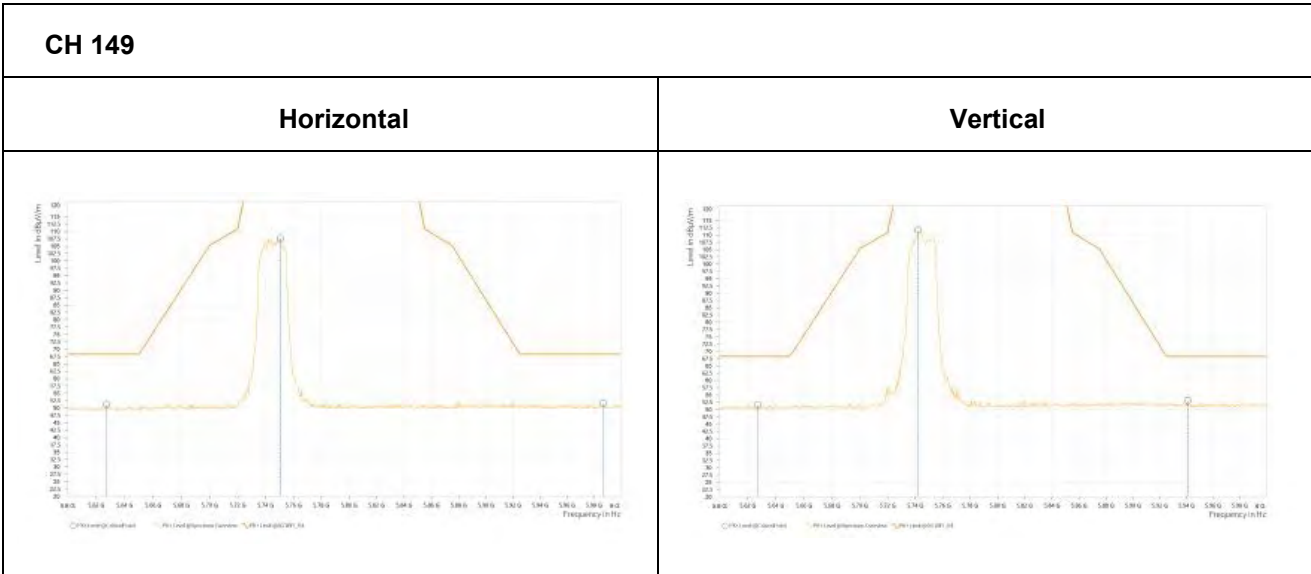



ANTENNA POLARITY & TEST DISTANCE: HORIZONTAL AT 3 M

Rg	Frequency [MHz]	PK+ Level [dBμV/m]	PK+ Limit [dBμV/m]	PK+ Margin [dB]	Correction [dB]	Polarization	Azimuth [deg]	Antenna Height [m]
11	5,644.688	50.92	68.20	17.28	13.71	H	5	1
12	5,788.440	108.46			14.17	H	263.4	1
13	5,955.750	50.96	68.20	17.24	14.52	H	1	2

ANTENNA POLARITY & TEST DISTANCE: VERTICAL AT 3 M

Rg	Frequency [MHz]	PK+ Level [dBμV/m]	PK+ Limit [dBμV/m]	PK+ Margin [dB]	Correction [dB]	Polarization	Azimuth [deg]	Antenna Height [m]
12	5,624.000	52.09	68.20	16.11	13.59	V	239.8	2
12	5,784.000	111.21			14.15	V	359	1
12	5,926.500	52.90	68.20	15.30	14.48	V	344.6	1

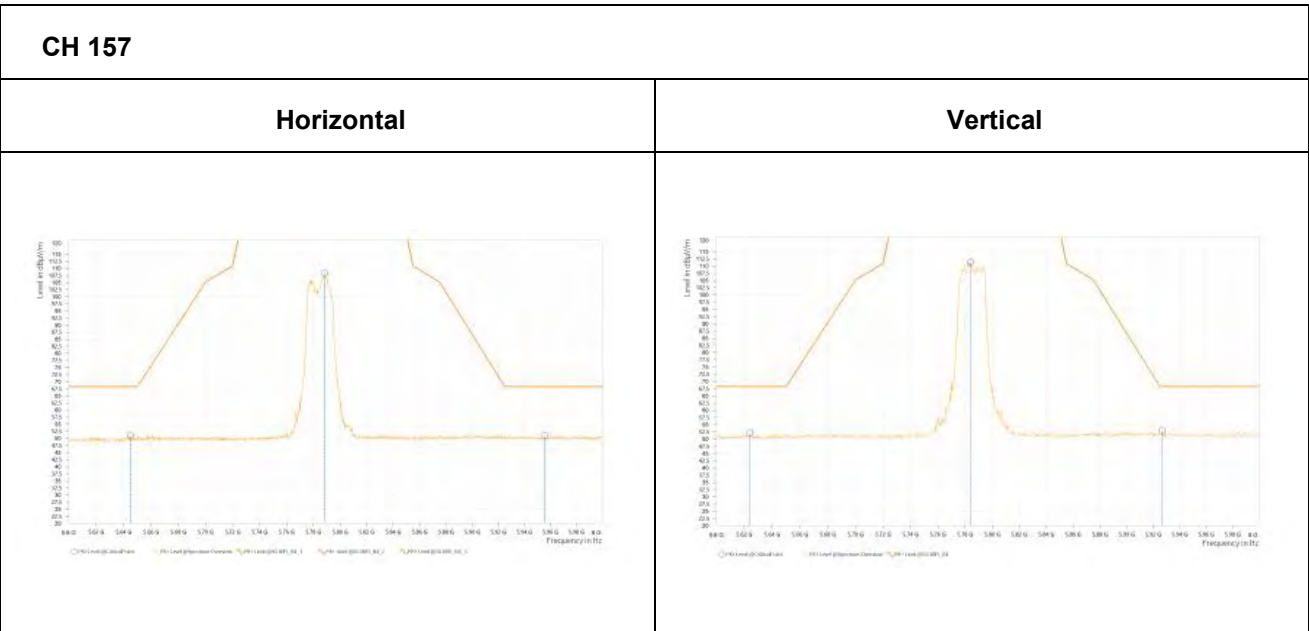



ANTENNA POLARITY & TEST DISTANCE: HORIZONTAL AT 3 M

Rg	Frequency [MHz]	PK+ Level [dBμV/m]	PK+ Limit [dBμV/m]	PK+ Margin [dB]	Correction [dB]	Polarization	Azimuth [deg]	Antenna Height [m]
11	5,643.438	50.96	68.20	17.24	13.70	H	353	1
12	5,826.560	108.79			14.25	H	264.6	1
13	5,988.375	52.39	68.20	15.81	14.62	H	359.1	1

ANTENNA POLARITY & TEST DISTANCE: VERTICAL AT 3 M

Rg	Frequency [MHz]	PK+ Level [dBμV/m]	PK+ Limit [dBμV/m]	PK+ Margin [dB]	Correction [dB]	Polarization	Azimuth [deg]	Antenna Height [m]
12	5,610.000	51.87	68.20	16.33	13.51	V	341.4	1
12	5,823.000	110.73			14.25	V	359.1	1
12	5,991.000	53.10	68.20	15.10	14.63	V	1	1

CH 165

Horizontal

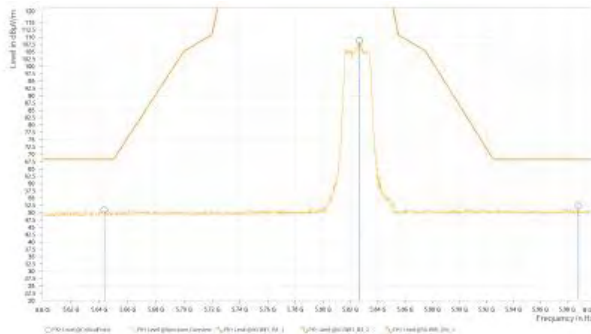

Vertical

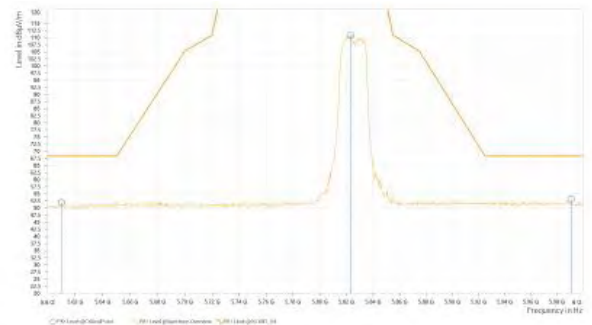



802.11ax (40MHz)

ANTENNA POLARITY & TEST DISTANCE: HORIZONTAL AT 3 M

Rg	Frequency [MHz]	PK+ Level [dBμV/m]	PK+ Limit [dBμV/m]	PK+ Margin [dB]	Correction [dB]	Polarization	Azimuth [deg]	Antenna Height [m]
12	5,644.063	50.62	68.20	17.58	13.70	H	219.2	1
13	5,746.880	105.11			14.03	H	86.5	1
14	5,960.625	51.24	68.20	16.96	14.53	H	1	1

ANTENNA POLARITY & TEST DISTANCE: VERTICAL AT 3 M

Rg	Frequency [MHz]	PK+ Level [dBμV/m]	PK+ Limit [dBμV/m]	PK+ Margin [dB]	Correction [dB]	Polarization	Azimuth [deg]	Antenna Height [m]
12	5,622.188	51.50	68.20	16.70	13.58	V	4.3	1
13	5,763.750	108.95			14.07	V	1	1
14	5,932.125	52.64	68.20	15.56	14.48	V	359.1	1

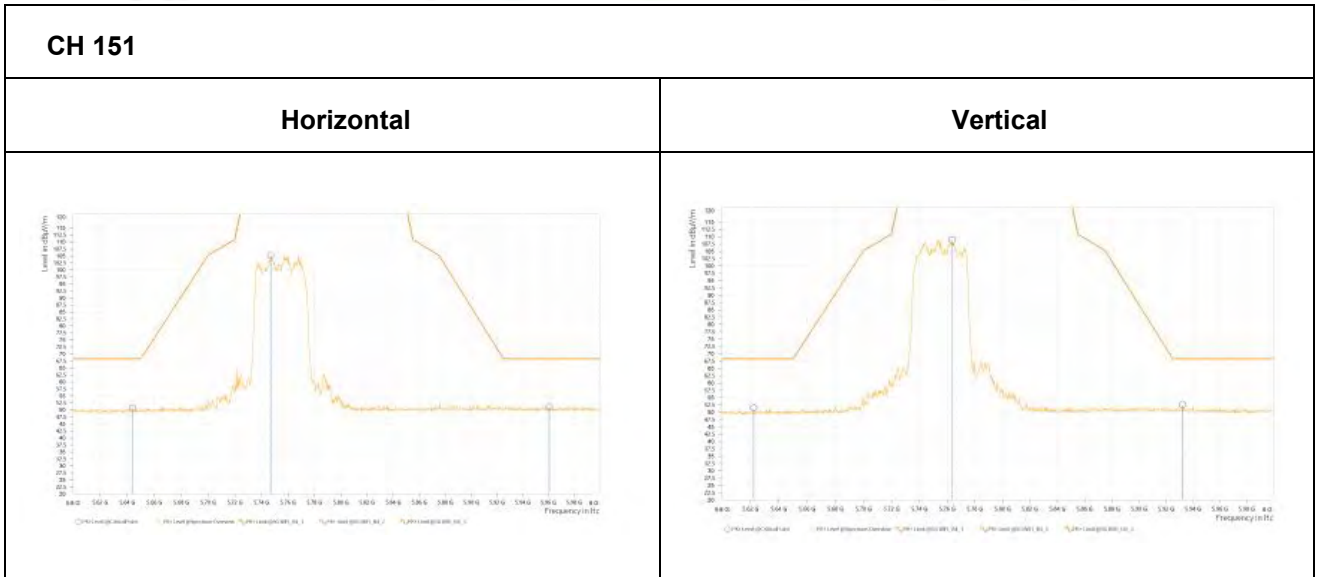



ANTENNA POLARITY & TEST DISTANCE: HORIZONTAL AT 3 M

Rg	Frequency [MHz]	PK+ Level [dBμV/m]	PK+ Limit [dBμV/m]	PK+ Margin [dB]	Correction [dB]	Polarization	Azimuth [deg]	Antenna Height [m]
12	5,643.438	50.73	68.20	17.47	13.70	H	359	1
13	5,787.810	106.12			14.17	H	268.2	1
14	5,925.375	51.48	68.20	16.72	14.48	H	317.3	1

ANTENNA POLARITY & TEST DISTANCE: VERTICAL AT 3 M

Rg	Frequency [MHz]	PK+ Level [dBμV/m]	PK+ Limit [dBμV/m]	PK+ Margin [dB]	Correction [dB]	Polarization	Azimuth [deg]	Antenna Height [m]
12	5,649.063	51.87	68.20	16.33	13.73	V	359.1	1
13	5,793.440	110.27			14.19	V	1	1
14	5,945.625	51.59	68.20	16.61	14.49	V	359	2

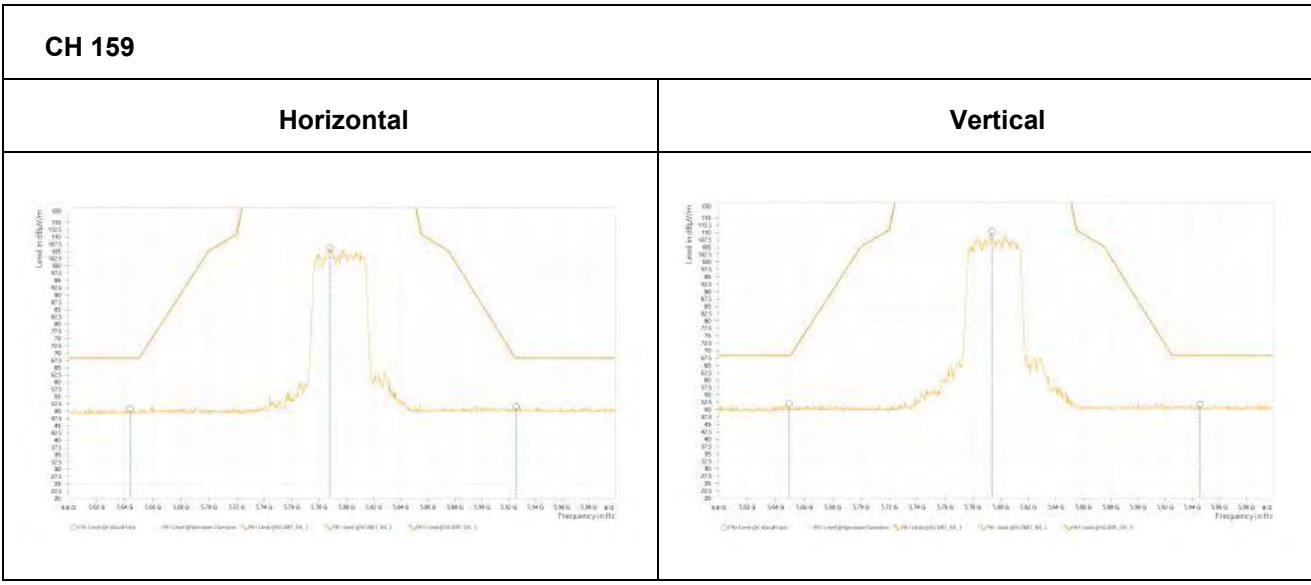



802.11ax (80MHz)

ANTENNA POLARITY & TEST DISTANCE: HORIZONTAL AT 3 M

Rg	Frequency [MHz]	PK+ Level [dBμV/m]	PK+ Limit [dBμV/m]	PK+ Margin [dB]	Correction [dB]	Polarization	Azimuth [deg]	Antenna Height [m]
6	5,639.063	51.88	68.20	16.32	13.67	H	5.7	1
7	5,789.380	104.20			14.17	H	265.9	1
8	5,941.875	51.38	68.20	16.82	14.49	H	189.7	2

ANTENNA POLARITY & TEST DISTANCE: VERTICAL AT 3 M

Rg	Frequency [MHz]	PK+ Level [dBμV/m]	PK+ Limit [dBμV/m]	PK+ Margin [dB]	Correction [dB]	Polarization	Azimuth [deg]	Antenna Height [m]
6	5,643.750	51.37	68.20	16.83	13.70	V	1	1
7	5,773.750	107.07			14.11	V	1	1
8	5,928.375	52.19	68.20	16.01	14.48	V	178.6	1

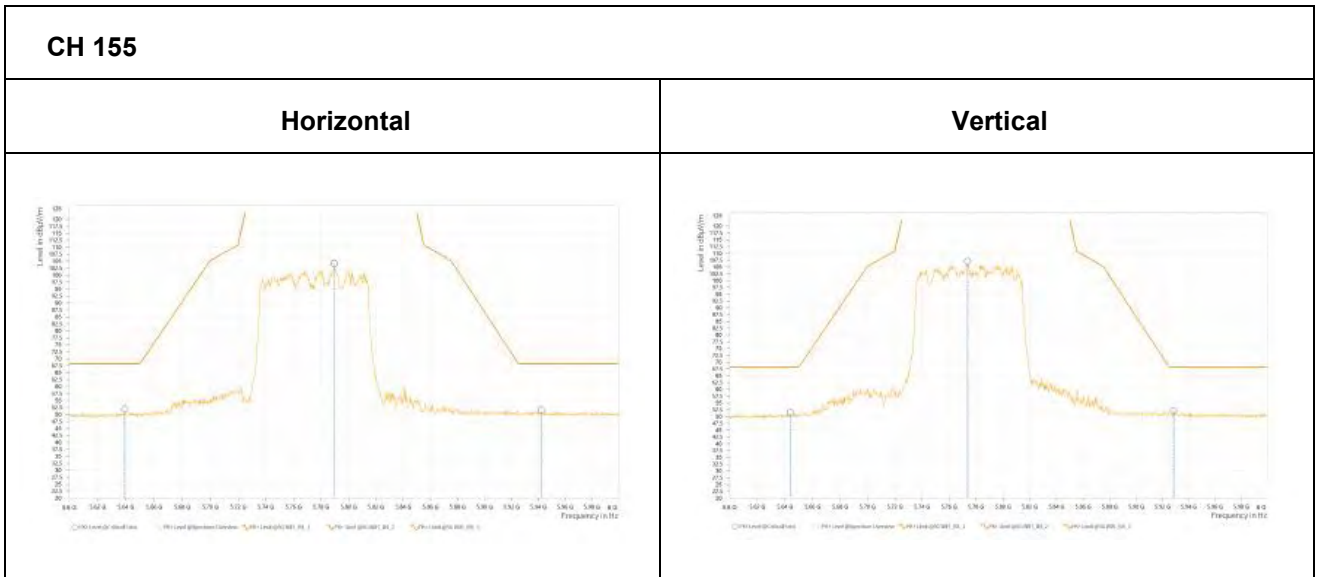



802.11n (40MHZ)

Worst case harmonic:

CHANNEL	TX Channel 151	DETECTOR FUNCTION	Peak (PK)
FREQUENCY RANGE	1GHz ~ 40GHz		Average (AV)

ANTENNA POLARITY & TEST DISTANCE: HORIZONTAL AT 3 M

Rg	Frequency [MHz]	PK+ Level [dBμV/m]	PK+ Limit [dBμV/m]	PK+ Margin [dB]	AVG Level [dBμV/m]	AVG Limit [dBμV/m]	AVG Margin [dB]	Correction [dB]	Polarization	Azimuth [deg]	Antenna Height [m]
4	11,510.000	45.07	74.00	28.93	34.47	54.00	19.53	12.05	H	358.6	2
4	17,265.000	50.95	74.00	23.05	40.20	54.00	13.80	21.76	H	1	2

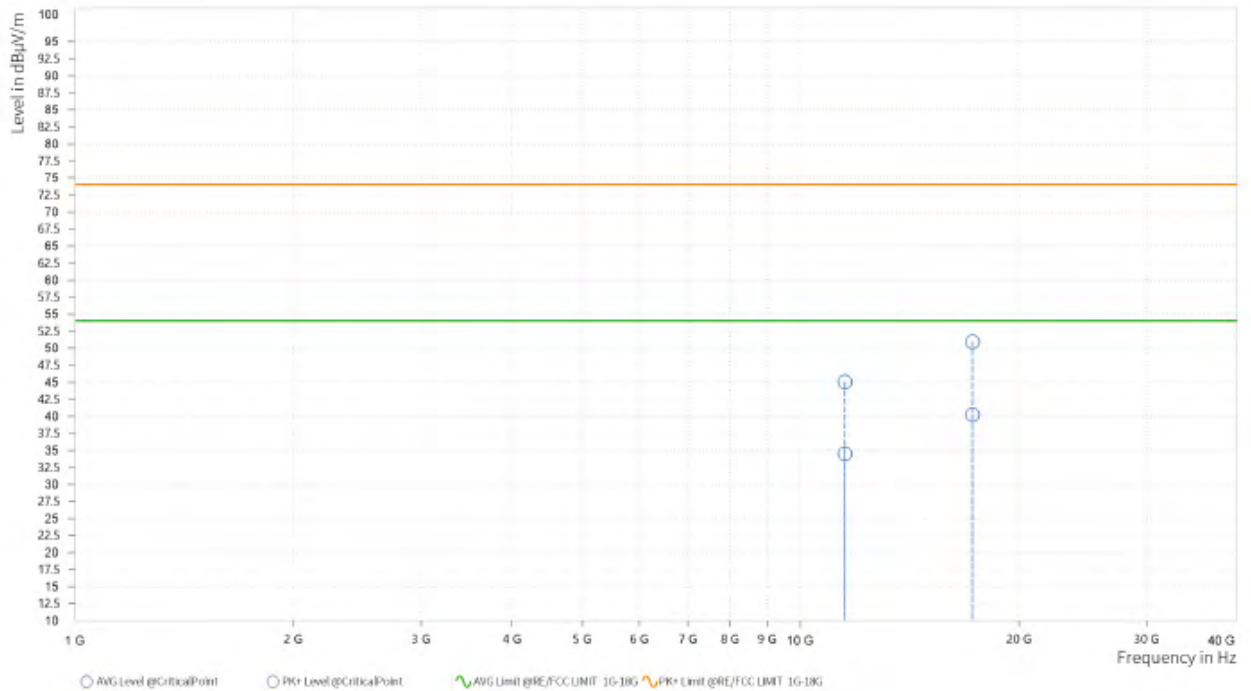



ANTENNA POLARITY & TEST DISTANCE: VERTICAL AT 3 M

Rg	Frequency [MHz]	PK+ Level [dBμV/m]	PK+ Limit [dBμV/m]	PK+ Margin [dB]	AVG Level [dBμV/m]	AVG Limit [dBμV/m]	AVG Margin [dB]	Correction [dB]	Polarization	Azimuth [deg]	Antenna Height [m]
4	11,510.000	44.73	74.00	29.27	34.07	54.00	19.93	12.05	V	359.1	2
4	17,265.000	50.02	74.00	23.98	40.24	54.00	13.76	21.76	V	359.1	2

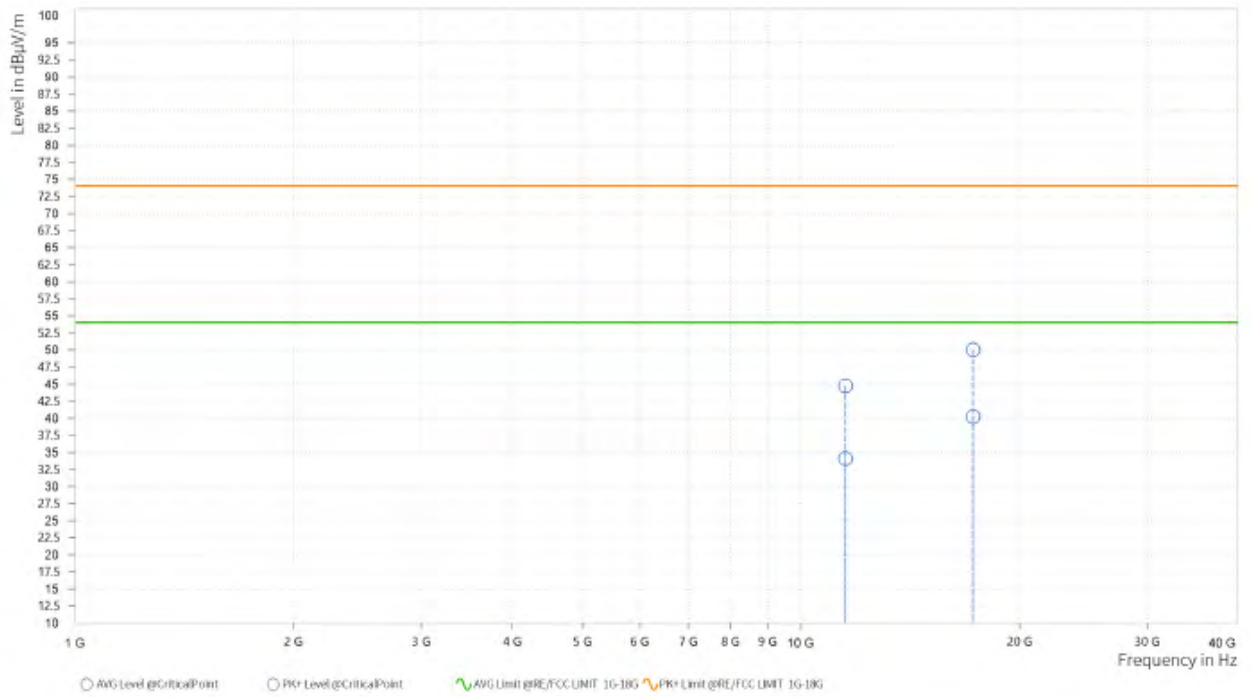

REMARKS:

- Emission Level = Read Level+ Antenna Factor + Cable Loss- Preamp Factor
Margin value = Limit value – Emission Level.
- 5755MHz: Fundamental frequency.



5G WIFI-RU

802.11ax (20MHz) (RU26):

ANTENNA POLARITY & TEST DISTANCE: HORIZONTAL AT 3 M

Rg	Frequency [MHz]	PK+ Level [dBμV/m]	PK+ Limit [dBμV/m]	PK+ Margin [dB]	Correction [dB]	Polarization	Azimuth [deg]	Antenna Height [m]
12	5,637.500	50.76	68.20	17.44	13.67	H	99.8	1
12	5,737.000	108.83			14.02	H	12.6	1
12	5,963.500	51.14	68.20	17.06	14.54	H	1	1

ANTENNA POLARITY & TEST DISTANCE: VERTICAL AT 3 M

Rg	Frequency [MHz]	PK+ Level [dBμV/m]	PK+ Limit [dBμV/m]	PK+ Margin [dB]	Correction [dB]	Polarization	Azimuth [deg]	Antenna Height [m]
12	5,631.000	51.03	68.20	17.17	13.63	V	225.6	2
12	5,736.500	111.04			14.02	V	359.1	1
12	5,944.000	51.98	68.20	16.22	14.49	V	179	2

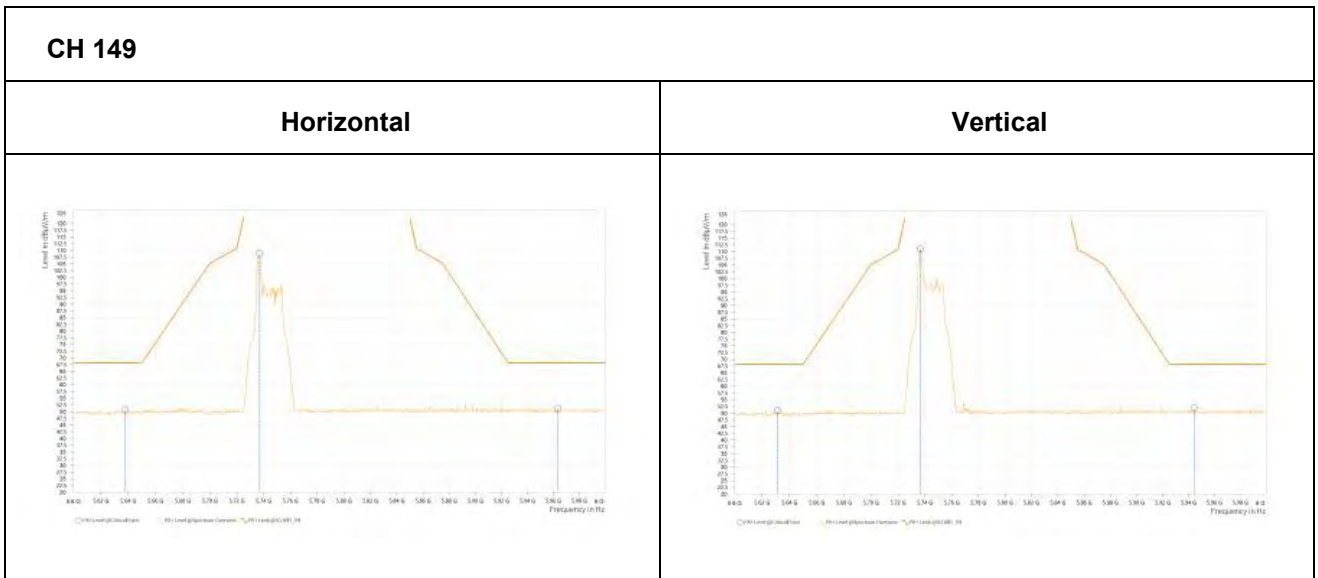



ANTENNA POLARITY & TEST DISTANCE: HORIZONTAL AT 3 M

Rg	Frequency [MHz]	PK+ Level [dBμV/m]	PK+ Limit [dBμV/m]	PK+ Margin [dB]	Correction [dB]	Polarization	Azimuth [deg]	Antenna Height [m]
12	5,602.000	51.16	68.20	17.04	13.47	H	318.8	2
12	5,786.000	107.63			14.16	H	85.7	2
12	5,991.500	51.62	68.20	16.58	14.63	H	359	2

ANTENNA POLARITY & TEST DISTANCE: VERTICAL AT 3 M

Rg	Frequency [MHz]	PK+ Level [dBμV/m]	PK+ Limit [dBμV/m]	PK+ Margin [dB]	Correction [dB]	Polarization	Azimuth [deg]	Antenna Height [m]
12	5,619.000	51.36	68.20	16.84	13.56	V	136.7	1
12	5,786.000	110.58			14.16	V	1	1
12	5,969.500	52.48	68.20	15.72	14.56	V	0.9	2

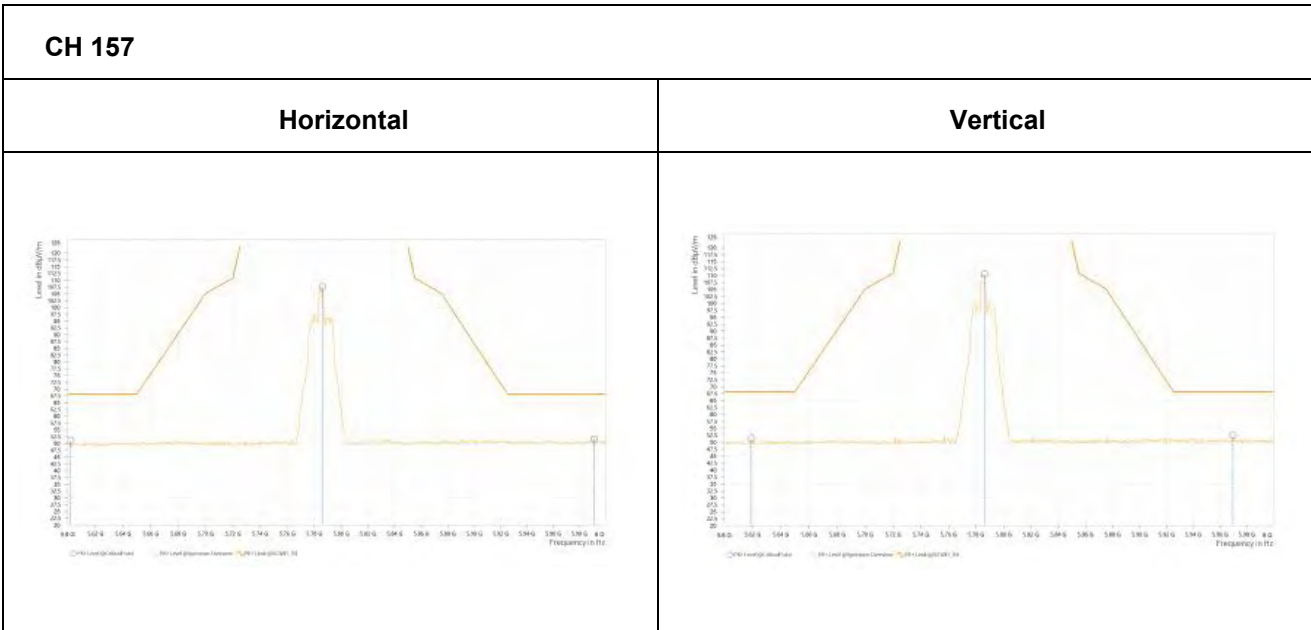



ANTENNA POLARITY & TEST DISTANCE: HORIZONTAL AT 3 M

Rg	Frequency [MHz]	PK+ Level [dBμV/m]	PK+ Limit [dBμV/m]	PK+ Margin [dB]	Correction [dB]	Polarization	Azimuth [deg]	Antenna Height [m]
12	5,633.000	50.60	68.20	17.60	13.64	H	183.4	1
12	5,833.000	107.74			14.26	H	5	1
12	5,929.500	51.43	68.20	16.77	14.48	H	42.4	1

ANTENNA POLARITY & TEST DISTANCE: VERTICAL AT 3 M

Rg	Frequency [MHz]	PK+ Level [dBμV/m]	PK+ Limit [dBμV/m]	PK+ Margin [dB]	Correction [dB]	Polarization	Azimuth [deg]	Antenna Height [m]
12	5,608.500	51.30	68.20	16.90	13.50	V	44.8	1
12	5,833.500	109.30			14.26	V	359	1
12	5,984.500	51.63	68.20	16.57	14.61	V	6.4	1

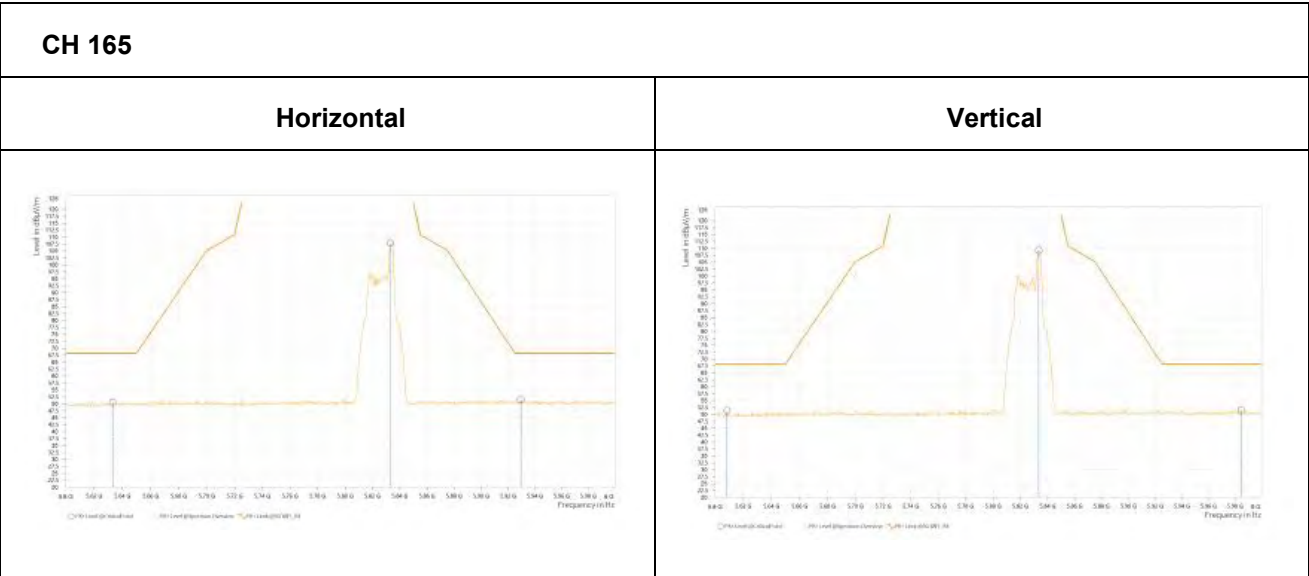



3.2 CONDUCTED EMISSION MEASUREMENT

3.2.1 LIMITS OF CONDUCTED EMISSION MEASUREMENT

FREQUENCY OF EMISSION (MHz)	CONDUCTED LIMIT (dB μ V)	
	Quasi-peak	Average
0.15 ~ 0.5	66 to 56	56 to 46
0.5 ~ 5	56	46
5 ~ 30	60	50

- NOTE:**
1. The lower limit shall apply at the transition frequencies.
 2. The limit decreases in line with the logarithm of the frequency in the range of 0.15 to 0.50MHz.
 3. All emanations from a class A/B digital device or system, including any network of conductors and apparatus connected thereto, shall not exceed the level of field strengths specified above.

3.2.2 TEST INSTRUMENTS

Equipment	Manufacturer	Model No.	Serial No.	Last Cal.	Next Cal.
EMI Test Receiver	Rohde&Schwarz	ESR3	102749	Feb.25,22	Feb.24,24
ELEKTRA test software	Rohde&Schwarz	ELEKTRA	NA	N/A	N/A
LISN network	Rohde&Schwarz	ENV216	102640	Feb.17,22	Feb.16,24
CABLE	Rohde&Schwarz	W61.01	N/A	Apr.28,23	Oct.27,23
CABLE	Rohde&Schwarz	W61.01	N/A	Oct.27,23	Apr.26,24
CABLE	Rohde&Schwarz	W601	N/A	Apr.28,23	Oct.27,23
CABLE	Rohde&Schwarz	W601	N/A	Oct.27,23	Apr.26,24

NOTE:

1. The test was performed in CE shielded room.
2. The calibration interval of the above test instruments is 6 months or 24 months. And the calibrations are traceable to CEPREI/CHINA, GRGT/CHINA and NIM/CHINA.



3.2.3 TEST PROCEDURES

- a. The EUT was placed 0.4 meters from the conducting wall of the shielded room with EUT being connected to the power mains through a line impedance stabilization network (LISN). Other support units were connected to the power mains through another LISN. The two LISNs provide 50 ohm/ 50uH of coupling impedance for the measuring instrument.
- b. Both lines of the power mains connected to the EUT were checked for maximum conducted interference.
- c. The frequency range from 150kHz to 30MHz was searched. Emission levels under (Limit - 20dB) was not recorded.

NOTE: All modes of operation were investigated and the worst-case emissions are reported.



3.2.4 DEVIATION FROM TEST STANDARD

No deviation.

3.2.5 TEST SETUP

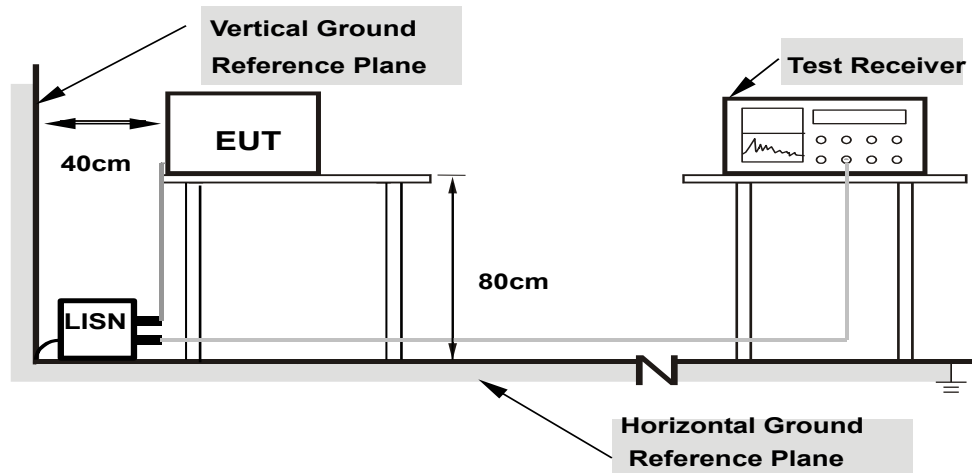

- Note: 1.Support units were connected to second LISN.
2.Both of LISNs (AMN) are 80 cm from EUT and at least 80
from other units and other metal planes**

For the actual test configuration, please refer to the attached file (Test Setup Photo).

3.2.6 EUT OPERATING CONDITIONS

Same as 3.1.7.



3.2.7 TEST RESULTS

CONDUCTED WORST-CASE DATA:

Frequency Range	150KHz ~ 30MHz	Detector Function & Resolution Bandwidth	Quasi-Peak (QP) / Average (AV), 9 kHz
Input Power	120Vac, 60Hz	Environmental Conditions	26deg. C, 51%RH
Tested By	Carl Xie		

Re	Frequency [MHz]	QPK Level [dBuV]	QPK Limit [dBuV]	QPK Margin [dB]	CAV Level [dBuV]	CAV: AVG Limit [dBuV]	CAV Margin [dB]	Correction [dB]	Line	Meas. BW [kHz]
1	0.150	60.75	66.00	5.25	39.76	56.00	16.24	12.57	L1	9.000
1	0.375	37.48	58.39	20.91	20.87	48.39	27.52	11.77	L1	9.000
1	1.455	12.29	56.00	43.71	0.39	46.00	45.61	11.76	L1	9.000
1	3.471	13.92	56.00	42.08	2.98	46.00	43.02	11.78	L1	9.000
1	10.140	40.54	60.00	19.46	27.48	50.00	22.52	11.83	L1	9.000
1	23.829	18.53	60.00	41.47	8.46	50.00	41.54	11.89	L1	9.000

- REMARKS:**
1. Q.P. and AV. are abbreviations of quasi-peak and average individually.
 2. "-": The Quasi-peak reading value also meets average limit and measurement with the average detector is unnecessary.
 3. The emission levels of other frequencies were very low against the limit.
 4. Margin value = Limit value - Emission level
 5. Correction factor = Insertion loss + Cable loss
 6. Emission Level = Correction Factor + Reading Value.

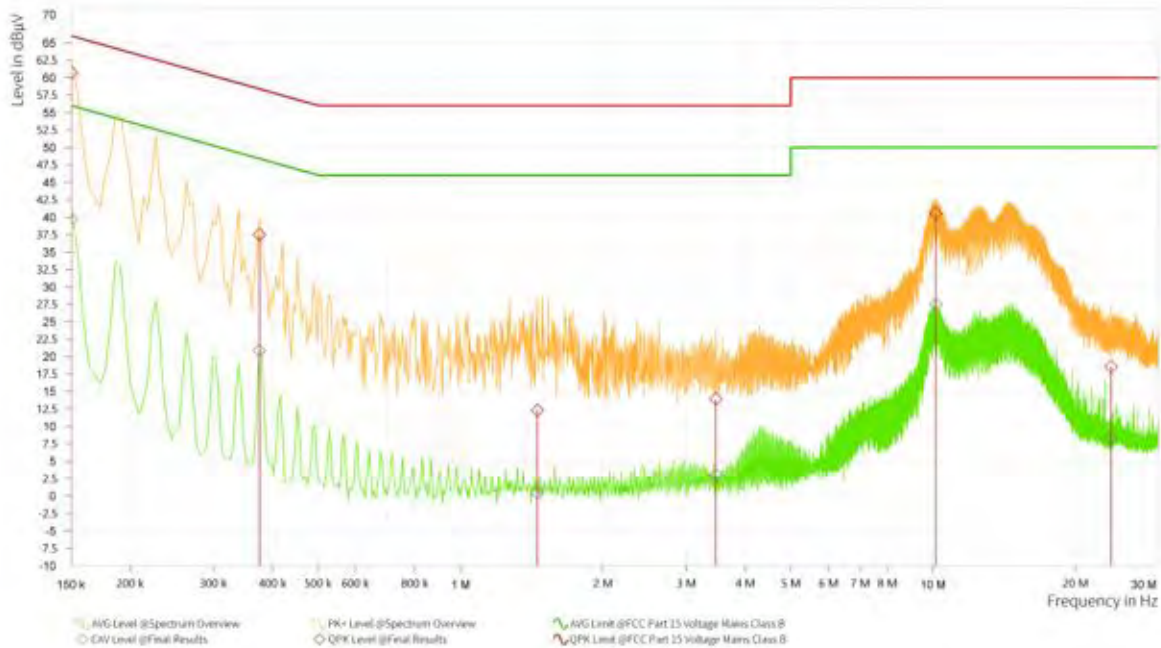



Frequency Range	150KHz ~ 30MHz	Detector Function & Resolution Bandwidth	Quasi-Peak (QP) / Average (AV), 9 kHz
Input Power	120Vac, 60Hz	Environmental Conditions	26deg. C, 51%RH
Tested By	Carl Xie		

Req	Frequency [MHz]	QPK Level [dBuV]	QPK Limit [dBuV]	QPK Margin [dB]	CAV Level [dBuV]	CAV: AVG Limit [dBuV]	CAV Margin [dB]	Correction [dB]	Line	Meas. BW [kHz]
1	0.150	60.18	66.00	5.82	39.19	56.00	16.81	12.13	N	9.000
1	0.375	38.26	58.39	20.13	20.13	48.39	28.26	12.83	N	9.000
1	1.163	12.53	56.00	43.47	2.86	46.00	43.14	12.74	N	9.000
1	2.490	20.35	56.00	35.65	9.39	46.00	36.61	12.75	N	9.000
1	10.176	40.92	60.00	19.08	28.30	50.00	21.70	12.79	N	9.000
1	23.127	20.91	60.00	39.09	17.57	50.00	32.43	12.87	N	9.000

- REMARKS:**
1. Q.P. and AV. are abbreviations of quasi-peak and average individually.
 2. "-": The Quasi-peak reading value also meets average limit and measurement with the average detector is unnecessary.
 3. The emission levels of other frequencies were very low against the limit.
 4. Margin value = Limit value - Emission level
 5. Correction factor = Insertion loss + Cable loss
 6. Emission Level = Correction Factor + Reading Value.

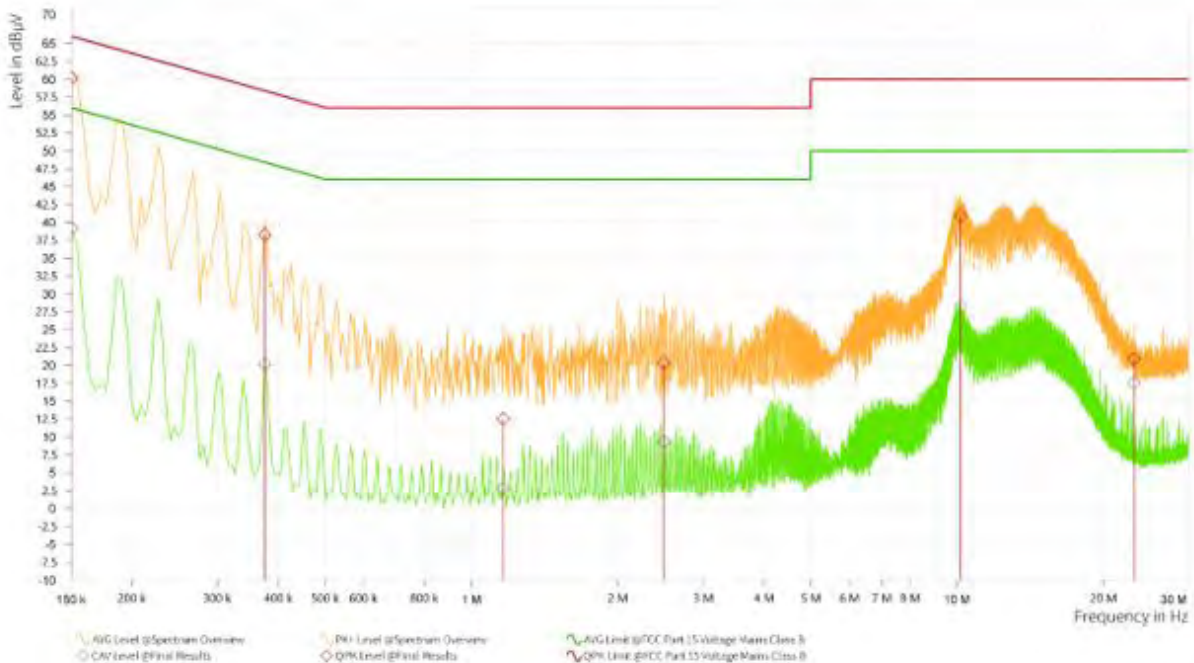



3.3 AUTOMATICALLY DISCONTINUE TRANSMISSION

3.3.1 LIMIT OF AUTOMATICALLY DISCONTINUE TRANSMISSION

The device shall automatically discontinue transmission in case of either absence of information to transmit or operational failure. These provisions are not intended to preclude the transmission of control or signaling information or the use of repetitive codes used by certain digital technologies to complete frame or burst intervals. Applicants shall include in their application for equipment authorization a description of how this requirement is met.

3.3.2 TEST INSTRUMENTS

Refer to section 3.1.3 to get information about the above instrument.

3.3.3 TEST RESULT

While the EUT is not transmitting any information, the EUT can automatically discontinue transmission and become standby mode for power saving。 The EUT can detect the controlling of ACK message transmitting from remote device and verify whether it shall resend or discontinue transmission.



Test Report No.: W7L-P23070010RF11

4 PHOTOGRAPHS OF THE TEST CONFIGURATION

Please refer to the attached file (Test Setup Photo).



Test Report No.: W7L-P23070010RF11

5 MODIFICATIONS RECORDERS FOR ENGINEERING CHANGES TO THE EUT BY THE LAB

No modifications were made to the EUT by the lab during the test.

---END---