



Test Report No.: W7L-P23030025RF08



FCC TEST REPORT (PART 90)



Applicant:	Thundercomm Technology Co., Ltd
Address:	No. 107, Middle Datagu Road, Xiantao Street, Yubei District, Chongqing, China, 401122

Manufacturer or Supplier	Thundercomm Technology Co., Ltd
Address	No. 107, Middle Datagu Road, Xiantao Street, Yubei District, Chongqing, China, 401122
Product	TurboX CM2290-NA
Brand Name	TURBOX
Model Name	TurboX CM2290-NA
FCC ID	2AOHHCM2290NA
Date of tests	Apr. 07, 2023 ~ Apr. 26, 2023

The tests have been carried out according to the requirements of the following standard:

- FCC Part 90, Subpart R, S ANSI/TIA/EIA-603- D
- FCC Part 2 ANSI/TIA/EIA-603-E ANSI C63.26-2015

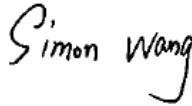
CONCLUSION: The submitted sample was found to COMPLY with the test requirement

Prepared by Simon Wang Engineer / Mobile Department	Approved by Luke Lu Manager / Mobile Department
	
Date: Apr. 26, 2023	Date: Apr. 26, 2023

This report is governed by, and incorporates by reference, the Conditions of Testing as posted at the date of issuance of this report at <http://www.bureauveritas.com/home/about-us/our-business/cps/about-us/terms-conditions> and is intended for your exclusive use. Any copying or replication of this report to or for any other person or entity, or use of our name or trademark, is permitted only with our prior written permission. This report sets forth our findings solely with respect to the test samples identified herein. The results set forth in this report are not indicative or representative of the quality or characteristics of the lot from which a test sample was taken or any similar or identical product unless specifically and expressly noted. Our report includes all of the tests requested by you and the results thereof based upon the information that you provided to us. Measurement uncertainty is only provided upon request for accredited tests. Statements of conformity are based on simple acceptance criteria without taking measurement uncertainty into account, unless otherwise requested in writing. You have 60 days from date of issuance of this report to notify us of any material error or omission caused by our negligence or if you require measurement uncertainty; provided, however, that such notice shall be in writing and shall specifically address the issue you wish to raise. A failure to raise such issue within the prescribed time shall constitute your unqualified acceptance of the completeness of this report, the tests conducted and the correctness of the report contents.



TABLE OF CONTENTS

RELEASE CONTROL RECORD	4
1 SUMMARY OF TEST RESULTS	5
1.1 MEASUREMENT UNCERTAINTY	6
1.2 TEST SITE AND INSTRUMENTS	7
2 GENERAL INFORMATION.....	8
2.1 GENERAL DESCRIPTION OF EUT	8
2.2 CONFIGURATION OF SYSTEM UNDER TEST	10
2.3 DESCRIPTION OF SUPPORT UNITS	11
2.4 DESCRIPTION OF TEST MODES.....	11
2.5 GENERAL DESCRIPTION OF APPLIED STANDARDS	14
3 TEST TYPES AND RESULTS	15
3.1 OUTPUT POWER MEASUREMENT	15
3.1.1 LIMITS OF OUTPUT POWER MEASUREMENT	15
3.1.2 TEST PROCEDURES	15
3.1.3 TEST SETUP	16
3.1.4 TEST RESULTS	16
3.2 FREQUENCY STABILITY MEASUREMENT	28
3.2.1 LIMITS OF FREQUENCY STABILITY MEASUREMENT	28
3.2.2 TEST PROCEDURE	28
3.2.3 TEST SETUP	28
3.2.4 TEST RESULTS	29
3.3 OCCUPIED BANDWIDTH MEASUREMENT	30
3.3.1 LIMITS OF OCCUPIED BANDWIDTH MEASUREMENT	30
3.3.2 TEST SETUP	30
3.3.3 TEST PROCEDURES	30
3.3.4 TEST RESULTS	31
3.4 EMISSION MASK MEASUREMENT.....	32
3.4.1 LIMITS OF EMISSION MASK MEASUREMENT	32
3.4.2 TEST SETUP	33
3.4.3 TEST PROCEDURES	34
3.4.4 TEST RESULTS	35
3.5 CONDUCTED SPURIOUS EMISSIONS.....	36
3.5.1 LIMITS OF CONDUCTED SPURIOUS EMISSIONS MEASUREMENT	36
3.5.2 TEST PROCEDURE	36
3.5.3 TEST SETUP	36
3.5.4 TEST RESULTS	37
3.6 RADIATED EMISSION MEASUREMENT	38
3.6.1 LIMITS OF RADIATED EMISSION MEASUREMENT	38
3.6.2 TEST PROCEDURES	38
3.6.3 DEVIATION FROM TEST STANDARD	38
3.6.4 TEST SETUP	39
3.6.5 TEST RESULTS	41
3.7 PEAK TO AVERAGE RATIO	59
3.7.1 LIMITS OF PEAK TO AVERAGE RATIO MEASUREMENT	59
3.7.2 TEST SETUP	59
3.7.3 TEST PROCEDURES	59
3.7.4 TEST RESULTS	60



**BUREAU
VERITAS**

Test Report No.: W7L-P23030025RF08

4	INFORMATION ON THE TESTING LABORATORIES	61
5	MODIFICATIONS RECORDERS FOR ENGINEERING CHANGES TO THE EUT BY THE LAB	62
6	APPENDIX	63
	LTE BAND 14	63
	LTE BAND26	90



Test Report No.: W7L-P23030025RF08

RELEASE CONTROL RECORD

ISSUE NO.	REASON FOR CHANGE	DATE ISSUED
W7L-P23030025RF08	Original release	Apr. 26, 2023



1 SUMMARY OF TEST RESULTS

The EUT has been tested according to the following specifications:

APPLIED STANDARD: FCC Part 90 & Part 2			
STANDARD SECTION	TEST TYPE AND LIMIT	RESULT	TEST LAB*
§2.1046 §90.635(b)	Conducted Output Power (Band26)	PASS	A
§90.541(d)	Effective Radiated Power (Band14)	PASS	A
§2.1055 §90.213 §90.539	Frequency Stability	PASS	A
§2.1049 §90.209	Occupied Bandwidth	PASS	A
§2.1051 §90.543(e)(f) §90.691(a)	Emission Masks	PASS	A
§2.1051 §90.543(e)(f) §90.691(a)	Conducted Spurious Emissions	PASS	A
§2.1053 §90.691	Radiated Spurious Emissions	PASS	A

***Test Lab Information Reference**

Lab A:

BV 7Layers Communications Technology (Shenzhen) Co., Ltd

Lab Address:

No.B102, Dazu Chuangxin Mansion, North of Beihuan Avenue, North Area, Hi-Tech Industrial Park, Nanshan District, Shenzhen, Guangdong, China

Accredited Test Lab Cert 3939.01

The FCC Site Registration No. : 525120; Designation No. : CN1171;



1.1 MEASUREMENT UNCERTAINTY

Where relevant, the following measurement uncertainty levels have been estimated for tests performed on the EUT as specified in CISPR 16-4-2:

MEASUREMENT	FREQUENCY	UNCERTAINTY
Conducted emissions	9kHz~30MHz	2.66dB
Radiated emissions	9KHz ~ 30MHz	2.68dB
	30MHz ~ 1GHz	3.26dB
	1GHz ~ 18GHz	4.48dB
	18GHz ~ 40GHz	4.12dB

This uncertainty represents an expanded uncertainty expressed at approximately the 95% confidence level using a coverage factor of k=2.



1.2 TEST SITE AND INSTRUMENTS

Equipment	Manufacturer	Model No.	Serial No.	Last Cal.	Next Cal.
MXE EMI Receiver	KEYSIGHT	N9038A-544	MY54450026	Feb. 17,23	Feb. 16,24
EXA Signal Analyzer	KEYSIGHT	N9010A-544	MY54510355	May.14,22	May.13,23
Loop Antenna	Schwarzbeck	FMZB 1519B	00173	Sep.03,22	Sep.02,23
Bilog Antenna	ETS-LINDGREN	3143B	00161965	Mar. 05,23	Mar. 04,24
Horn Antenna	ETS-LINDGREN	3117	00168692	Mar. 05,23	Mar. 04,24
Horn Antenna (18GHz-40GHz)	N/A	QWH-SL-18-40-K-SG/QMS-00361	15433	Sep.04, 22	Sep.03, 23
Radio Communication Analyzer	ANRITSU	MT8820C	6201465426	Feb. 14,23	Feb. 13,24
Signal Pre-Amplifier	EMSI	EMC 9135	980249	May.12,22	May.11,23
Signal Pre-Amplifier	EMSI	EMC 012645B	980257	May.12,22	May.11,23
Signal Pre-Amplifier	EMSI	EMC 184045B	980259	Feb. 17,23	Feb.16,24
3m Semi-anechoic Chamber	ETS-LINDGREN	9m*6m*6m	Euroshieldpn-CT0001143-1216	May. 19,20	May. 18,23
Test Software	E3	V 9.160323	N/A	N/A	N/A
Test Software	JS1120	3.1.36	N/A	N/A	N/A
10dB Attenuator	JFW/USA	50HF-010-SMA	N/A	May. 12,22	May. 11,23
Power Meter	Anritsu	ML2495A	1506002	Feb. 14,23	Feb. 13,24
Power Sensor	Anritsu	MA2411B	1339352	Feb. 14,23	Feb. 13,24
Temperature Chamber	ESPEC	SH-242	93000855	May. 12,22	May. 11,23
MXG Analog Microwave Signal Generator	KEYSIGHT	N5183A	MY50143024	Feb. 14,23	Feb. 13,24
Base station R&S CMW500	Rohde&Schwarz	CMW500	153085	May.12,22	May.11,23
DC Source	Kikusui/JP	PMX18-5A	N/A	Aug. 12,22	Aug. 11,23

- NOTE:**
1. The calibration interval of the above test instruments is 12 months or 36 months and the calibrations are traceable to CEPREI/CHINA, GRGT/CHINA and NIM/CHINA.
 2. The test was performed in 3m Semi-anechoic Chamber and RF Oven Room.
 3. The horn antenna is used only for the measurement of emission frequency above 1GHz if tested.
 4. The FCC Site Registration No. is 525120; The Designation No. is CN1171.

2 GENERAL INFORMATION

2.1 GENERAL DESCRIPTION OF EUT

PRODUCT	TurboX CM2290-NA	
BRAND NAME	TURBOX	
MODEL NAME	TurboX CM2290-NA	
NOMINAL VOLTAGE	EUT 4.0V	
MODULATION TECHNOLOGY	LTE	QPSK, 16QAM, 64QAM
FREQUENCY RANGE	LTE Band 14 Channel Bandwidth: 5MHz	790.5MHz ~ 795.5MHz
	LTE Band 14 Channel Bandwidth: 10MHz	793MHz
	LTE Band 26 (Channel Bandwidth: 1.4MHz)	814.7MHz ~ 823.3MHz
	LTE Band 26 (Channel Bandwidth: 3MHz)	815.5MHz ~ 822.5MHz
	LTE Band 26 (Channel Bandwidth: 5MHz)	816.5MHz ~ 821.5MHz
	LTE Band 26 (Channel Bandwidth: 10MHz)	819MHz
EMISSION DESIGNATOR	LTE Band 14 Channel Bandwidth: 5MHz	QPSK: 4M50G7D
		16QAM: 4M50W7D
		64QAM: 4M50W7D
	LTE Band 14 Channel Bandwidth: 10MHz	QPSK: 8M97G7D
		16QAM: 8M95W7D
		64QAM: 8M95W7D
	LTE Band 26 (Channel Bandwidth: 1.4MHz)	QPSK: 1M09G7D
		16QAM: 1M09W7D
		64QAM: 1M09W7D
	LTE Band 26 (Channel Bandwidth: 3MHz)	QPSK: 2M70G7D
		16QAM: 2M70W7D
		64QAM: 2M70W7D
LTE Band 26 (Channel Bandwidth: 5MHz)	QPSK: 4M49G7D	
	16QAM: 4M50W7D	
	64QAM: 4M50W7D	
LTE Band 26 (Channel Bandwidth: 10MHz)	QPSK: 8M98G7D	
	16QAM: 8M97W7D	
	64QAM: 8M96W7D	

MAX. EIRP POWER	LTE Band 14 Channel Bandwidth: 5MHz	238.78mW
	LTE Band 14 Channel Bandwidth: 10MHz	239.33mW
	LTE Band 26 (Channel Bandwidth: 1.4MHz)	241.55mW
	LTE Band 26 (Channel Bandwidth: 3MHz)	241.55mW
	LTE Band 26 (Channel Bandwidth: 5MHz)	242.1mW
	LTE Band 26 (Channel Bandwidth: 10MHz)	242.66mW
ANTENNA TYPE	Flex Antenna	
ANTENNA GAIN	2.5 dBi for LTE Band 14/ LTE Band 26	
HW VERSION	V06	
SW VERSION	FlatBuild_Turbox-CM2290_cm2290_la1.0.1.v.userdebug.20230301.1952	
I/O PORTS	Refer to user's manual	
DATA CABLE	N/A	
EXTREME TEMPERATURE	-25-75 °C	
EXTREME VOLTAGE	3.4V - 4.35V	

NOTE:

1. For a more detailed features description, please refer to the manufacturer's specifications or the user's manual.

The EUT incorporates a SISO function. Physically, the EUT provides one completed transmitter and one receiver.

MODULATION MODE	TX FUNCTION
LTE	1TX/1RX

2. For the test results, the EUT had been tested with all conditions. But only the worst case was shown in test report.

2.2 CONFIGURATION OF SYSTEM UNDER TEST

FOR RADIATION EMISSION TEST

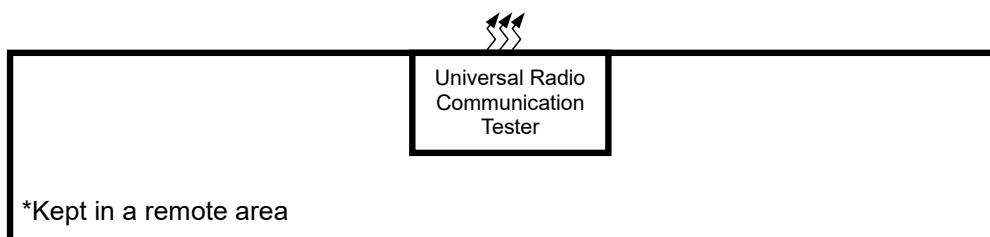
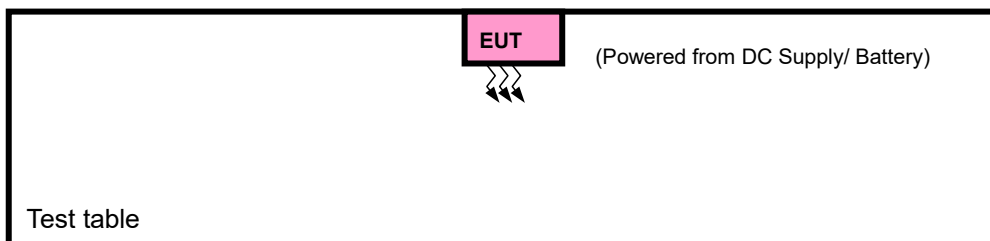
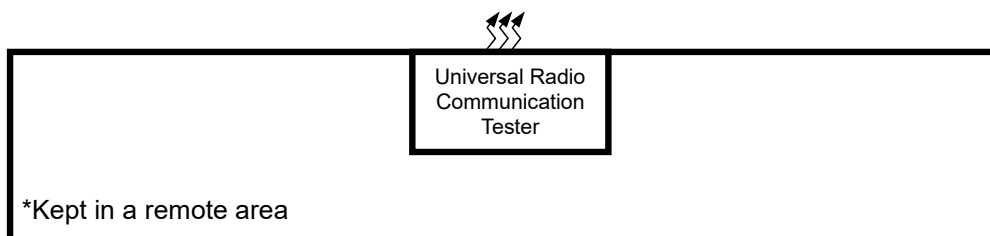
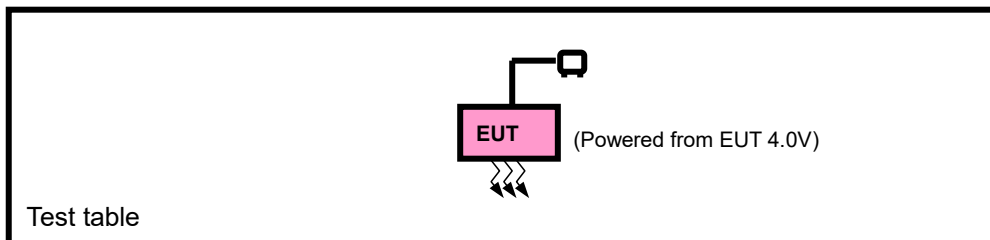



2.3 DESCRIPTION OF SUPPORT UNITS

The EUT has been tested as an independent unit together with other necessary accessories or support units. The following support units or accessories were used to form a representative test configuration during the tests.

NO.	PRODUCT	BRAND	MODEL NO.	SERIAL NO.	FCC ID
1	DC source	LONG WEI	PS-6403D	010934269	N/A

NO.	SIGNAL CABLE DESCRIPTION OF THE ABOVE SUPPORT UNITS
1	DC Line: Unshielded, Detachable 1.8m

2.4 DESCRIPTION OF TEST MODES

Pre-Scan has been conducted to determine the worst-case mode from all possible combinations between available modulations, data rates, XYZ axis and antenna ports. The worst case in ERP/EIRP and radiated emission was found when positioned on X-plane for LTE. Following channel(s) was (were) selected for the final test as listed below:

EUT CONFIGURE MODE	DESCRIPTION
A	EUT + adapter with LTE link
B	EUT + DC source with LTE link



Test Report No.: W7L-P23030025RF08

LTE BAND 14 MODE

EUT CONFIGURE MODE	TEST ITEM	AVAILABLE CHANNEL	TESTED CHANNEL	CHANNEL BANDWIDTH	MODULATION	MODE
A	ERP	23305 to 23355	23305, 23330, 23355	5MHz	QPSK,16QAM,64QAM	1 RB / 0 RB Offset
		23330	23330	10MHz	QPSK,16QAM,64QAM	1 RB / 0 RB Offset
B	FREQUENCY STABILITY	23330	23330	10MHz	QPSK	50 RB / 0 RB Offset
A	OCCUPIED BANDWIDTH	23305 to 23355	23305, 23330, 23355	5MHz	QPSK,16QAM,64QAM	25 RB / 0 RB Offset
		23330	23330	10MHz	QPSK,16QAM,64QAM	50 RB / 0 RB Offset
A	BAND EDGE	23305 to 23355	23305	5MHz	QPSK,16QAM, 64QAM	1 RB / 0 RB Offset
						25 RB / 0 RB Offset
			23355	5MHz	QPSK,16QAM, 64QAM	1 RB / 24 RB Offset
		23300	23330	10MHz	QPSK,16QAM, 64QAM	25 RB / 0 RB Offset
						1 RB / 0 RB Offset
						50 RB / 0 RB Offset
				1 RB / 49 RB Offset		
				/		
A	PEAK TO AVERAGE RATIO	23300	23330	10MHz	QPSK,16QAM, 64QAM	1 RB / 0 RB Offset 50 RB / 0 RB Offset
A	CONDUCTED EMISSION	23305 to 23355	23305, 23330, 23355	5MHz	QPSK,16QAM,64QAM	1 RB / 0 RB Offset
		23330	23330	10MHz	QPSK,16QAM,64QAM	1 RB / 0 RB Offset
A	RADIATED EMISSION	23305 to 23355	23305, 23330, 23355	5MHz	QPSK	1 RB / 0 RB Offset
		23330	23330	10MHz	QPSK	1 RB / 0 RB Offset

Note: This device was tested under all bandwidths, RB configurations and modulations. The worst case was found in QPSK modulation.



Test Report No.: W7L-P23030025RF08

LTE BAND 26 MODE

EUT CONFIGURE MODE	TEST ITEM	AVAILABLE CHANNEL	TESTED CHANNEL	CHANNEL BANDWIDTH	MODULATION	MODE		
A	ERP	26697 to 26783	26697, 26740, 26783	1.4MHz	QPSK, 16QAM, 64QAM	1 RB / 0 RB Offset		
		26705 to 26775	26705, 26740, 26775	3MHz	QPSK, 16QAM, 64QAM	1 RB / 0 RB Offset		
		26715 to 26765	26715, 26740, 26765	5MHz	QPSK, 16QAM, 64QAM	1 RB / 0 RB Offset		
		26740	26740	10MHz	QPSK, 16QAM, 64QAM	1 RB / 0 RB Offset		
B	FREQUENCY STABILITY	26740	26740	10MHz	QPSK	50 RB / 0 RB Offset		
A	OCCUPIED BANDWIDTH	26697 to 26783	26697, 26740, 26783	1.4MHz	QPSK, 16QAM, 64QAM	6 RB / 0 RB Offset		
		26705 to 26775	26705, 26740, 26775	3MHz	QPSK, 16QAM, 64QAM	15 RB / 0 RB Offset		
		26715 to 26765	26715, 26740, 26765	5MHz	QPSK, 16QAM, 64QAM	25 RB / 0 RB Offset		
		26740	26740	10MHz	QPSK, 16QAM, 64QAM	50 RB / 0 RB Offset		
A	BAND EDGE	26697 to 26783	26697	1.4MHz	QPSK, 16QAM, 64QAM	1 RB / 0 RB Offset 6 RB / 0 RB Offset		
			26783	1.4MHz	QPSK, 16QAM, 64QAM	1 RB / 5 RB Offset 6 RB / 0 RB Offset		
		26705 to 26775	26705	3MHz	QPSK, 16QAM, 64QAM	1 RB / 0 RB Offset 15 RB / 0 RB Offset		
			26775	3MHz	QPSK, 16QAM, 64QAM	1 RB / 14 RB Offset 15 RB / 0 RB Offset		
		26715 to 26765	26715	5MHz	QPSK, 16QAM, 64QAM	1 RB / 0 RB Offset 25 RB / 0 RB Offset		
			26765	5MHz	QPSK, 16QAM, 64QAM	1 RB / 24 RB Offset 25 RB / 0 RB Offset		
		26740	26740	10MHz	QPSK, 16QAM, 64QAM	1 RB / 0 RB Offset 50 RB / 0 RB Offset		
			26740	10MHz	QPSK, 16QAM, 64QAM	1 RB / 49 RB Offset 50 RB / 0 RB Offset		
		A	PEAK TO AVERAGE RATIO	26740	26740	10MHz	QPSK, 16QAM, 64QAM	1 RB / 0 RB Offset 50 RB / 0 RB Offset
		A	CONDUCTED EMISSION	26697 to 26783	26697, 26740, 26783	1.4MHz	QPSK	1 RB / 0 RB Offset
				26705 to 26775	26705, 26740, 26775	3MHz	QPSK	1 RB / 0 RB Offset
				26715 to 26765	26715, 26740, 26765	5MHz	QPSK	1 RB / 0 RB Offset
26740	26740			10MHz	QPSK	1 RB / 0 RB Offset		
A	RADIATED EMISSION	26697 to 26783	26740	1.4MHz	QPSK	1 RB / 0 RB Offset		
		26705 to 26775	26740	3MHz	QPSK	1 RB / 0 RB Offset		
		26715 to 26765	26740	5MHz	QPSK	1 RB / 0 RB Offset		
		26740	26740	10MHz	QPSK	1 RB / 0 RB Offset		

Note: This device was tested under all bandwidths, RB configurations and modulations. The worst case was found in QPSK modulation.



Test Report No.: W7L-P23030025RF08

TEST CONDITION:

TEST ITEM	ENVIRONMENTAL CONDITIONS	INPUT POWER	TESTED BY
EIRP(ERP)	24deg. C, 60%RH	EUT 4.0V	Jace Hu
FREQUENCY STABILITY	24deg. C, 61%RH	DC 3.4/4.0/4.35V By DC Source	James Fu
OCCUPIED BANDWIDTH	24deg. C, 61%RH	EUT 4.0V	James Fu
BAND EDGE	24deg. C, 61%RH	EUT 4.0V	James Fu
CONDUCTED EMISSION	24deg. C, 61%RH	EUT 4.0V	James Fu
RADIATED EMISSION	23deg. C, 70%RH	EUT 4.0V	Jace Hu

2.5 GENERAL DESCRIPTION OF APPLIED STANDARDS

The EUT is a RF product. According to the specifications of the manufacturer, it must comply with the requirements of the following standards:

FCC 47 CFR Part 2

FCC 47 CFR Part 90

ANSI/TIA/EIA-603-D

ANSI/TIA/EIA-603-E

ANSI C63.26-2015

NOTE: All test items have been performed and recorded as per the above standards.



3 TEST TYPES AND RESULTS

3.1 OUTPUT POWER MEASUREMENT

3.1.1 LIMITS OF OUTPUT POWER MEASUREMENT

Per FCC Part 90.541 (d):

The transmitting power of a portable (hand-held) unit must not exceed 3 watts ERP.

Per FCC Part 90.635 (b):

The maximum output power of the transmitter for mobile stations is 100 watts (20 dBw).

3.1.2 TEST PROCEDURES

EIRP / ERP MEASUREMENT:

Per KDB 971168 D01 Power Meas License Digital Systems v03r01 or subclause 5.2.5.5 of ANSI C63.26-2015, the relevant equation for determining the ERP or EIRP from the conducted RF output power measured using the guidance provided above is:

$$\text{ERP or EIRP} = P_{\text{Meas}} + G_{\text{T}} - L_{\text{C}}$$

Where:

ERP or EIRP = effective radiated power or equivalent isotropically radiated power, respectively

(expressed in the same units as P_{Meas} , typically dBW or dBm);

P_{Meas} = measured transmitter output power or PSD, in dBm or dBW;

G_{T} = gain of the transmitting antenna, in dBd (ERP) or dBi (EIRP);

L_{C} = signal attenuation in the connecting cable between the transmitter and antenna, in dB

CONDUCTED POWER MEASUREMENT:

- The EUT was set up for the maximum power with LTE link data modulation and link up with simulator.
- Set the EUT to transmit under low, middle and high channel and record the power level shown on simulator.

3.1.3 TEST SETUP

CONDUCTED POWER MEASUREMENT:

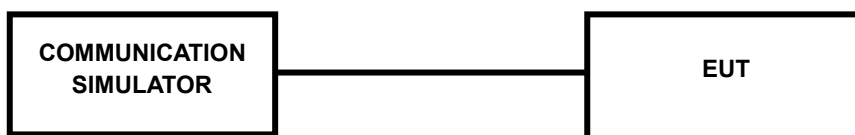

For the actual test configuration, please refer to the attached file (Test Setup Photo).

3.1.4 TEST RESULTS

AVERAGE CONDUCTED OUTPUT POWER (dBm)

LTE Band 14

Band/BW	Modulation	RB Size	RB Offset	Low CH 23305	Mid CH 23330	High CH 23355
				Frequency 790.5 MHz	Frequency 793 MHz	Frequency 795.5 MHz
14/ 5	QPSK	1	0	23.01	23.08	23.04
		1	12	23.40	23.39	23.43
		1	24	23.31	23.35	23.32
		12	0	22.32	22.34	22.37
		12	6	22.42	22.48	22.45
		12	13	22.35	22.29	22.35
		25	0	22.23	22.25	22.23
	16QAM	1	0	22.20	22.24	22.20
		1	12	22.15	22.17	22.20
		1	24	21.74	21.73	21.75
		12	0	21.29	21.31	21.34
		12	6	21.44	21.50	21.46
		12	13	21.32	21.39	21.38
		25	0	21.27	21.26	21.23
	64QAM	1	0	21.50	21.57	21.56
		1	12	22.01	22.00	21.97
		1	24	21.59	21.63	21.62
		12	0	20.40	20.42	20.45
		12	6	20.52	20.58	20.55
		12	13	20.50	20.44	20.50
		25	0	20.15	20.17	20.15



Test Report No.: W7L-P23030025RF08

Band/BW	Modulation	RB Size	RB Offset	/	Mid CH 23330	/
				/	Frequency 793 MHz	/
14/ 10	QPSK	1	0	/	23.09	/
		1	24	/	23.44	/
		1	49	/	23.37	/
		25	0	/	22.39	/
		25	12	/	22.50	/
		25	25	/	22.37	/
		50	0	/	22.31	/
	16QAM	1	0	/	22.26	/
		1	24	/	22.22	/
		1	49	/	21.80	/
		25	0	/	21.36	/
		25	12	/	21.52	/
		25	25	/	21.40	/
		50	0	/	21.31	/
	64QAM	1	0	/	21.58	/
		1	24	/	22.05	/
		1	49	/	21.65	/
		25	0	/	20.47	/
		25	12	/	20.60	/
		25	25	/	20.52	/
		50	0	/	20.23	/

LTE Band 26

Band/BW	Modulation	RB Size	RB Offset	Low CHG 26697	Mid CH 26740	High CH 26783
				Frequency 814.7 MHz	Frequency 819 MHz	Frequency 823.3 MHz
26/ 1.4	QPSK	1	0	23.08	23.12	23.11
		1	2	23.47	23.44	23.48
		1	5	23.12	23.07	23.09
		3	0	22.74	22.72	22.78
		3	1	22.76	22.75	22.69
		3	3	22.68	22.65	22.67
		6	0	22.26	22.21	22.25
	16QAM	1	0	22.32	22.30	22.32
		1	2	22.00	21.94	22.00
		1	5	21.70	21.67	21.74
		3	0	21.81	21.80	21.80
		3	1	21.75	21.82	21.78
		3	3	21.68	21.67	21.71
		6	0	21.32	21.36	21.33
	64QAM	1	0	21.51	21.53	21.56
		1	2	21.77	21.83	21.80
		1	5	21.48	21.42	21.48
		3	0	20.89	20.91	20.89
		3	1	20.89	20.93	20.89
		3	3	20.55	20.52	20.59
		6	0	20.37	20.36	20.36



**BUREAU
VERITAS**

Test Report No.: W7L-P23030025RF08

Band/BW	Modulation	RB Size	RB Offset	Low CHG 26705	Mid CH 26740	High CH 26775
				Frequency 815.5 MHz	Frequency 819 MHz	Frequency 822.5 MHz
26/ 3	QPSK	1	0	23.10	23.09	23.11
		1	7	23.43	23.45	23.48
		1	14	23.06	23.12	23.08
		8	0	22.22	22.29	22.28
		8	3	22.23	22.22	22.19
		8	7	22.15	22.22	22.21
		15	0	22.22	22.22	22.23
	16QAM	1	0	22.35	22.29	22.36
		1	7	21.94	21.98	21.97
		1	14	21.72	21.69	21.73
		8	0	21.33	21.28	21.30
		8	3	21.27	21.25	21.31
		8	7	21.21	21.20	21.14
		15	0	21.33	21.30	21.32
	64QAM	1	0	21.57	21.52	21.56
		1	7	21.80	21.83	21.78
		1	14	21.48	21.42	21.49
		8	0	20.39	20.43	20.42
		8	3	20.43	20.37	20.44
		8	7	20.02	20.06	20.05
		15	0	20.39	20.33	20.40

Band/BW	Modulation	RB Size	RB Offset	Low CHG 26715	Mid CH 26740	High CH 26765
				Frequency 816.5 MHz	Frequency 819 MHz	Frequency 821.5 MHz
26/ 5	QPSK	1	0	23.14	23.09	23.11
		1	12	23.48	23.42	23.49
		1	24	23.06	23.10	23.09
		12	0	22.27	22.24	22.28
		12	6	22.25	22.20	22.22
		12	13	22.17	22.15	22.21
		25	0	22.26	22.25	22.19
	16QAM	1	0	22.30	22.29	22.31
		1	12	21.99	21.96	22.00
		1	24	21.73	21.68	21.70
		12	0	21.29	21.27	21.33
		12	6	21.31	21.25	21.32
		12	13	21.14	21.18	21.17
		25	0	21.36	21.30	21.37
	64QAM	1	0	21.50	21.54	21.53
		1	12	21.82	21.79	21.83
		1	24	21.48	21.43	21.45
		12	0	20.41	20.39	20.45
		12	6	20.44	20.43	20.37
		12	13	20.05	20.02	20.04
		25	0	20.40	20.35	20.39



**BUREAU
VERITAS**

Test Report No.: W7L-P23030025RF08

Band/BW	Modulation	RB Size	RB Offset	/	Mid CH 26740	/
				/	Frequency 819 MHz	/
26/ 10	QPSK	1	0	/	23.16	/
		1	24	/	23.50	/
		1	49	/	23.14	/
		25	0	/	22.30	/
		25	12	/	22.27	/
		25	25	/	22.23	/
		50	0	/	22.27	/
	16QAM	1	0	/	22.37	/
		1	24	/	22.02	/
		1	49	/	21.75	/
		25	0	/	21.35	/
		25	12	/	21.33	/
		25	25	/	21.22	/
		50	0	/	21.38	/
	64QAM	1	0	/	21.58	/
		1	24	/	21.85	/
		1	49	/	21.50	/
		25	0	/	20.47	/
		25	12	/	20.45	/
		25	25	/	20.10	/
		50	0	/	20.41	/

ERP

LTE BAND 14

CHANNEL BANDWIDTH: 5MHz QPSK

Channel	Frequency (MHz)	Conducted Power (dBm)	G _T -L _c (dB)	ERP (dBm)	ERP (mW)	Limit (W)
23305	790.5	23.4	2.5	23.75	237.14	100
23330	793	23.39	2.5	23.74	236.59	100
23355	795.5	23.43	2.5	23.78	238.78	100

CHANNEL BANDWIDTH: 5MHz 16QAM

Channel	Frequency (MHz)	Conducted Power (dBm)	G _T -L _c (dB)	ERP (dBm)	ERP (mW)	Limit (W)
23305	790.5	22.2	2.5	22.55	179.89	100
23330	793	22.24	2.5	22.59	181.55	100
23355	795.5	22.2	2.5	22.55	179.89	100

CHANNEL BANDWIDTH: 5MHz 64QAM

Channel	Frequency (MHz)	Conducted Power (dBm)	G _T -L _c (dB)	ERP (dBm)	ERP (mW)	Limit (W)
23305	790.5	22.01	2.5	22.36	172.19	100
23330	793	22	2.5	22.35	171.79	100
23355	795.5	21.97	2.5	22.32	170.61	100



Test Report No.: W7L-P23030025RF08

CHANNEL BANDWIDTH: 10MHz QPSK

Channel	Frequency (MHz)	Conducted Power (dBm)	G _T -L _c (dB)	ERP (dBm)	ERP (mW)	Limit (W)
-	-	-	-	-	-	-
23330	793	23.44	2.5	23.79	239.33	100
-	-	-	-	-	-	-

CHANNEL BANDWIDTH: 10MHz 16QAM

Channel	Frequency (MHz)	Conducted Power (dBm)	G _T -L _c (dB)	ERP (dBm)	ERP (mW)	Limit (W)
-	-	-	-	-	-	-
23330	793	22.26	2.5	22.61	182.39	100
-	-	-	-	-	-	-

CHANNEL BANDWIDTH: 10MHz 64QAM

Channel	Frequency (MHz)	Conducted Power (dBm)	G _T -L _c (dB)	ERP (dBm)	ERP (mW)	Limit (W)
-	-	-	-	-	-	-
23330	793	22.05	2.5	22.4	173.78	100
-	-	-	-	-	-	-

REMARKS: ERP Output Power (dBm) = ERP (dBm) -2.15(dB).



Test Report No.: W7L-P23030025RF08

LTE BAND 26

CHANNEL BANDWIDTH: 1.4MHz QPSK

Channel	Frequency (MHz)	Conducted Power (dBm)	G _T -L _C (dB)	ERP (dBm)	ERP (mW)	Limit (W)
26697	814.7	23.47	2.5	23.82	240.99	100
26740	819	23.44	2.5	23.79	239.33	100
26783	823.3	23.48	2.5	23.83	241.55	100

REMARKS: ERP Output Power (dBm) = EIRP (dBm) -2.15(dB).

CHANNEL BANDWIDTH: 1.4MHz 16QAM

Channel	Frequency (MHz)	Conducted Power (dBm)	G _T -L _C (dB)	ERP (dBm)	ERP (mW)	Limit (W)
26697	814.7	22.32	2.5	22.67	184.93	100
26740	819	22.3	2.5	22.65	184.08	100
26783	823.3	22.32	2.5	22.67	184.93	100

REMARKS: ERP Output Power (dBm) = EIRP (dBm) -2.15(dB).

CHANNEL BANDWIDTH: 1.4MHz 64QAM

Channel	Frequency (MHz)	Conducted Power (dBm)	G _T -L _C (dB)	ERP (dBm)	ERP (mW)	Limit (W)
26697	814.7	21.77	2.5	22.12	162.93	100
26740	819	21.83	2.5	22.18	165.2	100
26783	823.3	21.8	2.5	22.15	164.06	100

REMARKS: ERP Output Power (dBm) = EIRP (dBm) -2.15(dB).



Test Report No.: W7L-P23030025RF08

LTE BAND 26

CHANNEL BANDWIDTH: 3MHz QPSK

Channel	Frequency (MHz)	Conducted Power (dBm)	G _T -L _c (dB)	ERP (dBm)	ERP (mW)	Limit (W)
26705	815.5	23.43	2.5	23.78	238.78	100
26740	819	23.45	2.5	23.8	239.88	100
26775	822.5	23.48	2.5	23.83	241.55	100

REMARKS: ERP Output Power (dBm) = EIRP (dBm) -2.15(dB).

CHANNEL BANDWIDTH: 3MHz 16QAM

Channel	Frequency (MHz)	Conducted Power (dBm)	G _T -L _c (dB)	ERP (dBm)	ERP (mW)	Limit (W)
26705	815.5	22.35	2.5	22.7	186.21	100
26740	819	22.29	2.5	22.64	183.65	100
26775	822.5	22.36	2.5	22.71	186.64	100

REMARKS: ERP Output Power (dBm) = EIRP (dBm) -2.15(dB).

CHANNEL BANDWIDTH: 3MHz 64QAM

Channel	Frequency (MHz)	Conducted Power (dBm)	G _T -L _c (dB)	ERP (dBm)	ERP (mW)	Limit (W)
26705	815.5	21.8	2.5	22.15	164.06	100
26740	819	21.83	2.5	22.18	165.2	100
26775	822.5	21.78	2.5	22.13	163.31	100

REMARKS: ERP Output Power (dBm) = EIRP (dBm) -2.15(dB).



Test Report No.: W7L-P23030025RF08

LTE BAND 26

CHANNEL BANDWIDTH: 5MHz QPSK

Channel	Frequency (MHz)	Conducted Power (dBm)	G _T -L _C (dB)	ERP (dBm)	ERP (mW)	Limit (W)
26715	816.5	23.48	2.5	23.83	241.55	100
26740	819	23.42	2.5	23.77	238.23	100
26765	821.5	23.49	2.5	23.84	242.1	100

REMARKS: ERP Output Power (dBm) = EIRP (dBm) -2.15(dB).

CHANNEL BANDWIDTH: 5MHz 16QAM

Channel	Frequency (MHz)	Conducted Power (dBm)	G _T -L _C (dB)	ERP (dBm)	ERP (mW)	Limit (W)
26715	816.5	22.3	2.5	22.65	184.08	100
26740	819	22.29	2.5	22.64	183.65	100
26765	821.5	22.31	2.5	22.66	184.5	100

REMARKS: ERP Output Power (dBm) = EIRP (dBm) -2.15(dB).

CHANNEL BANDWIDTH: 5MHz 64QAM

Channel	Frequency (MHz)	Conducted Power (dBm)	G _T -L _C (dB)	ERP (dBm)	ERP (mW)	Limit (W)
26715	816.5	21.82	2.5	22.17	164.82	100
26740	819	21.79	2.5	22.14	163.68	100
26765	821.5	21.83	2.5	22.18	165.2	100

REMARKS: ERP Output Power (dBm) = EIRP (dBm) -2.15(dB).



Test Report No.: W7L-P23030025RF08

LTE BAND 26

CHANNEL BANDWIDTH: 10MHz QPSK

Channel	Frequency (MHz)	Conducted Power (dBm)	G _T -L _c (dB)	ERP (dBm)	ERP (mW)	Limit (W)
-	-	-	-	-	-	-
26740	819	23.5	2.5	23.85	242.66	100
-	-	-	-	-	-	-

REMARKS: ERP Output Power (dBm) = EIRP (dBm) -2.15(dB).

CHANNEL BANDWIDTH: 10MHz 16QAM

Channel	Frequency (MHz)	Conducted Power (dBm)	G _T -L _c (dB)	ERP (dBm)	ERP (mW)	Limit (W)
-	-	-	-	-	-	-
26740	819	22.37	2.5	22.72	187.07	100
-	-	-	-	-	-	-

REMARKS: ERP Output Power (dBm) = EIRP (dBm) -2.15(dB).

CHANNEL BANDWIDTH: 10MHz 64QAM

Channel	Frequency (MHz)	Conducted Power (dBm)	G _T -L _c (dB)	ERP (dBm)	ERP (mW)	Limit (W)
-	-	-	-	-	-	-
26740	819	21.85	2.5	22.2	165.96	100
-	-	-	-	-	-	-

REMARKS: ERP Output Power (dBm) = EIRP (dBm) -2.15(dB).

3.2 FREQUENCY STABILITY MEASUREMENT

3.2.1 LIMITS OF FREQUENCY STABILITY MEASUREMENT

The frequency stability of mobile, portable and control transmitters operating in the wideband segment must be 1.25 parts per million or better when AFC is locked to a base station, and 5 parts per million or better when AFC is not locked

3.2.2 TEST PROCEDURE

- a. Device is placed at the oven room. The oven room could control the temperatures and humidity. Power warm up is at least 15 min and power applied should perform before recording frequency error.
- b. EUT is connected the external power supply to control the DC input power. The test voltage range is from minimum to maximum working voltage. Each step shall be record the frequency error rate.
- c. The temperature range step is 10 degrees in this test items. All temperature levels shall be hold the $\pm 0.5^{\circ}\text{C}$ during the measurement testing. The each temperature step shall be at least 0.5 hours, consider the EUT could be test under the stability condition.

NOTE: The frequency error was recorded frequency error from the communication simulator.

3.2.3 TEST SETUP

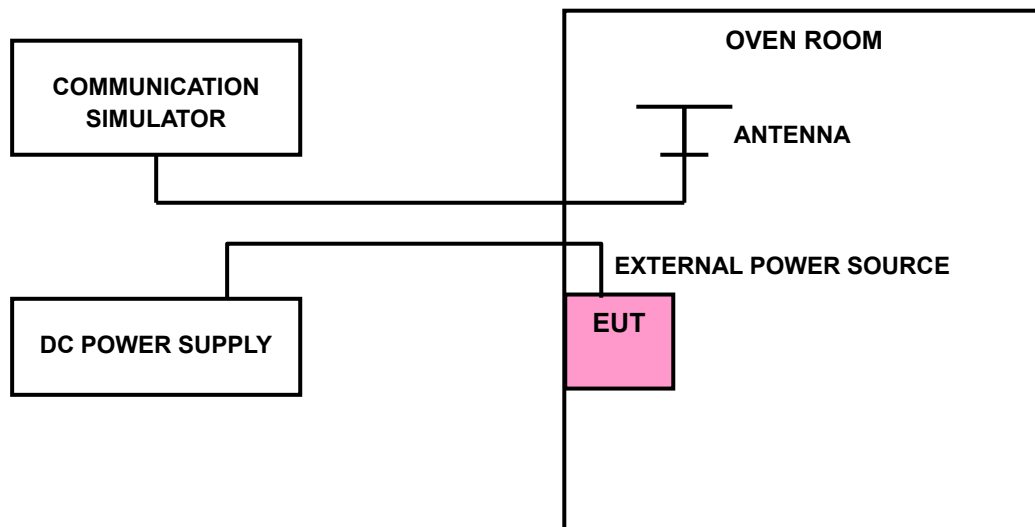



Test Report No.: W7L-P23030025RF08

3.2.4 TEST RESULTS

Please Refer to Appendix Of this test report.

3.3 OCCUPIED BANDWIDTH MEASUREMENT

3.3.1 LIMITS OF OCCUPIED BANDWIDTH MEASUREMENT

The width of a frequency band such that, below the lower and above the upper frequency limits, the mean powers emitted are each equal to a specified percentage 0.5 % of the total mean power of a given emission.

3.3.2 TEST SETUP

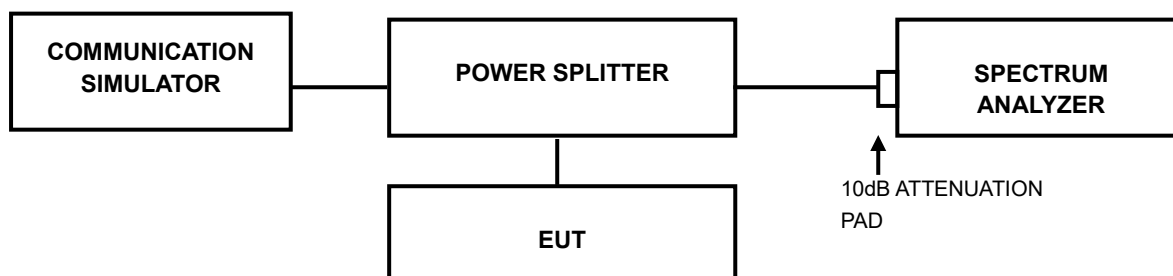

3.3.3 TEST PROCEDURES

- The conducted occupied bandwidth used the power splitter via EUT RF power connector between simulation base station and spectrum analyzer.
- Use OBW measurement function of Spectrum analyzer to measure 99 % occupied bandwidth.



Test Report No.: W7L-P23030025RF08

3.3.4 TEST RESULTS

Please Refer to Appendix Of this test report.

3.4 EMISSION MASK MEASUREMENT

3.4.1 LIMITS OF EMISSION MASK MEASUREMENT

LTE Band14:

According to FCC part 90.543(e) shall be tested the emission mask.

(e) For operations in the 758–768 MHz and the 788–798 MHz bands, the power of any emission outside the licensee's frequency band(s) of operation shall be attenuated below the transmitter power (P) within the licensed band(s) of operation, measured in watts, in accordance with the following:

- (1) On all frequencies between 769–775 MHz and 799–805 MHz, by a factor not less than $76 + 10 \log (P)$ dB in a 6.25 kHz band segment, for base and fixed stations.
- (2) On all frequencies between 769–775 MHz and 799–805 MHz, by a factor not less than $65 + 10 \log (P)$ dB in a 6.25 kHz band segment, for mobile and portable stations.
- (3) On any frequency between 775–788 MHz, above 805 MHz, and below 758 MHz, by at least $43 + 10 \log (P)$ dB.
- (4) Compliance with the provisions of paragraphs (e)(1) and (2) of this section is based on the use of measurement instrumentation such that the reading taken with any resolution bandwidth setting should be adjusted to indicate spectral energy in a 6.25 kHz segment.
- (5) Compliance with the provisions of paragraph (e)(3) of this section is based on the use of measurement instrumentation employing a resolution bandwidth of 100 kHz or greater. However, in the 100 kHz bands immediately outside and adjacent to the frequency block, a resolution bandwidth of 30 kHz may be employed.



BUREAU
VERITAS

Test Report No.: W7L-P23030025RF08

LTE Band26:

According to FCC part 90.691 shall be tested the emission mask. For any frequency removed from the EA licensee's frequency block by up to and including 37.5 kHz, the power of any emission shall be attenuated below the transmitter power (P) in watts by at least $116 \log_{10}(f/6.1)$ decibels or $50 + 10 \log_{10}(P)$ decibels or 80 decibels, whichever is the lesser attenuation, where f is the frequency removed from the center of the outer channel in the block in kilohertz and where f is greater than 12.5 kHz.

For any frequency removed from the EA licensee's frequency block greater than 37.5 kHz, the power of any emission shall be attenuated below the transmitter power (P) in watts by at least $43 + 10 \log_{10}(P)$ decibels or 80 decibels, whichever is the lesser attenuation, where f is the frequency removed from the center of the outer channel in the block in kilohertz and where f is greater than 37.5 kHz.

3.4.2 TEST SETUP

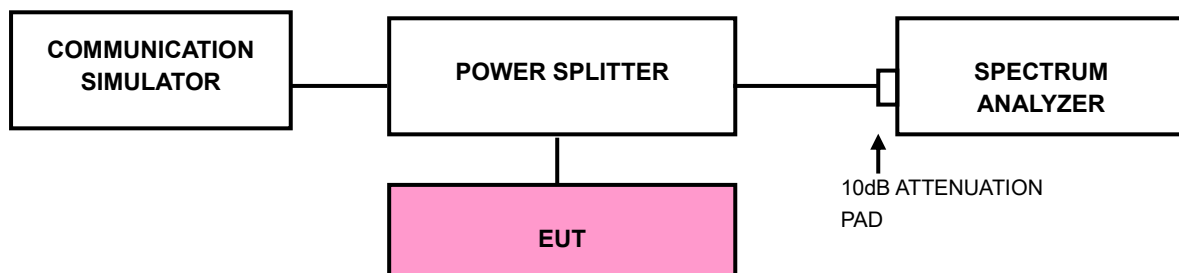



Test Report No.: W7L-P23030025RF08

3.4.3 TEST PROCEDURES

- a) Connect the transmitter to the spectrum analyzer via coaxial cable while ensuring proper impedance matching.
- b) Tune the analyzer to the nominal center frequency of the emission bandwidth (EBW).
- c) Set the resolution bandwidth (RBW) $\geq 1\%$ EBW in the 1MHz band immediately outside and adjacent to the band edge.
- d) Beyond the 1MHz band from the band edge, RBW=1MHz was used.
- e) Set the video bandwidth (VBW) to $\geq 3 \times$ RBW.
- f) Select the average power (RMS) display detector.
- g) Set the number of measurement points to ≥ 1001 .
- h) Use auto-coupled sweep time.
- i) Perform the measurement over an interval of time when the transmission is continuous and at its maximum power level.
- j) The RF fundamental frequency should be excluded against the limit line in the operating frequency band and use RBW is 10KHz or 100KHz.
- k) Record the max trace plot into the test report.



Test Report No.: W7L-P23030025RF08

3.4.4 TEST RESULTS

Please Refer to Appendix Of this test report.

3.5 CONDUCTED SPURIOUS EMISSIONS

3.5.1 LIMITS OF CONDUCTED SPURIOUS EMISSIONS MEASUREMENT

(1) The power of any emission outside a licensee's frequency block shall be attenuated below the transmitter power (P) by at least $43 + 10 \log_{10}(P)$ dB. The limit of emission equal to -13 dBm

(2) For operations in the 763–775 MHz and 793–805 MHz bands, all emissions including harmonics in the band 1559– 1610 MHz shall be limited to -70 dBW/MHz equivalent isotropically radiated power (EIRP) for wideband signals, and -80 dBW EIRP for discrete emissions of less than 700 Hz bandwidth. For the purpose of equipment authorization, a transmitter shall be tested with an antenna that is representative of the type that will be used with the equipment in normal operation.

3.5.2 TEST PROCEDURE

- a. The EUT makes a phone call to the communication simulator. All measurements were done at middle operational frequency range.
- b. Measuring frequency range is from 9kHz up to a frequency including its 10th harmonic. 10dB attenuation pad is connected with spectrum. RBW=1MHz and VBW=3MHz is used for conducted emission measurement.

3.5.3 TEST SETUP

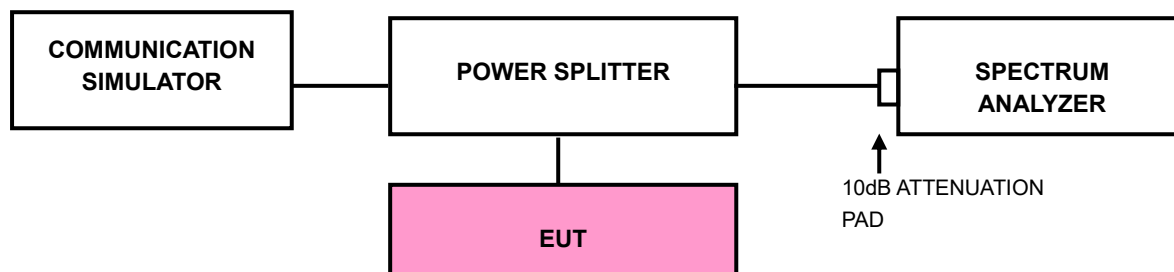



Test Report No.: W7L-P23030025RF08

3.5.4 TEST RESULTS

NOTE : The 9K~30MHz amplitude of spurious emissions attenuated more than 20 dB below the permissible value is not required in the report.

Please Refer to Appendix Of this test report.



3.6 RADIATED EMISSION MEASUREMENT

3.6.1 LIMITS OF RADIATED EMISSION MEASUREMENT

(1) The power of any emission outside a licensee's frequency block shall be attenuated below the transmitter power (P) by at least $43 + 10 \log_{10}(P)$ dB. The limit of emission equal to -13dBm

(2) For operations in the 763–775 MHz and 793–805 MHz bands, all emissions including harmonics in the band 1559–1610 MHz shall be limited to -70 dBW/MHz equivalent isotropically radiated power (EIRP) for wideband signals, and -80 dBW EIRP for discrete emissions of less than 700 Hz bandwidth. For the purpose of equipment authorization, a transmitter shall be tested with an antenna that is representative of the type that will be used with the equipment in normal operation.

3.6.2 TEST PROCEDURES

- a. Substitution method is used for E.I.R.P measurement. In the semi-anechoic chamber, EUT placed on the 0.8m height of Turn Table, rotated the table around 360 degrees to search the maximum radiation power and receiver antenna shall be rotated vertical and horizontal polarization and moved height from 1m to 4m to find the maximum polar radiated power. The “Read Value” is the spectrum reading the maximum power value.
- b. The substitution horn antenna is substituted for EUT at the same position and signals generator export the CW signal to the substitution antenna via a TX cable. Rotated the Turn Table and moved receiving antenna to find the maximum radiation power. Adjust output power level of S.G to get a Value of spectrum reading equal to “Read Value” of step a. Record the power level of S.G
- c. $\text{EIRP} = \text{Output power level of S.G} - \text{TX cable loss} + \text{Antenna gain of substitution horn.}$
- d. E.R.P power can be calculated form E.I.R.P power by subtracting the gain of dipole, $\text{E.R.P power} = \text{E.I.P.R power} - 2.15\text{dBi.}$

NOTE: The resolution bandwidth of spectrum analyzer is 1 MHz and the video bandwidth is 3 MHz.

3.6.3 DEVIATION FROM TEST STANDARD

No deviation

3.6.4 TEST SETUP

<Below 30MHz>

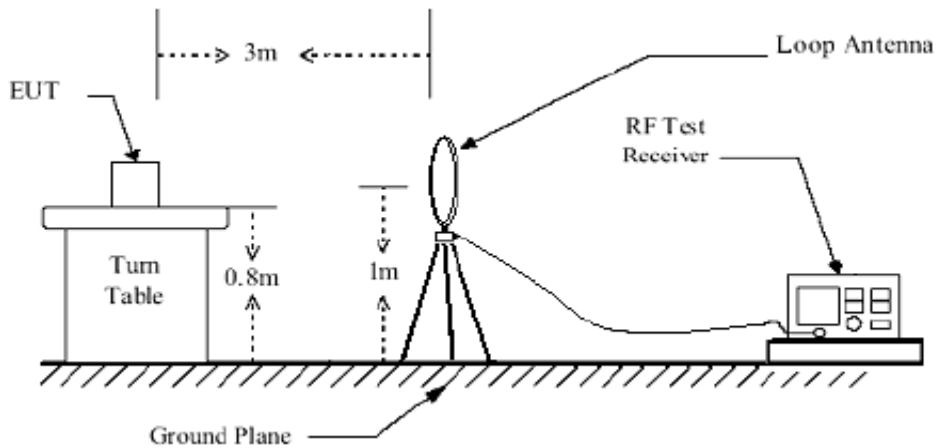

< Frequency Range 30MHz~1GHz >

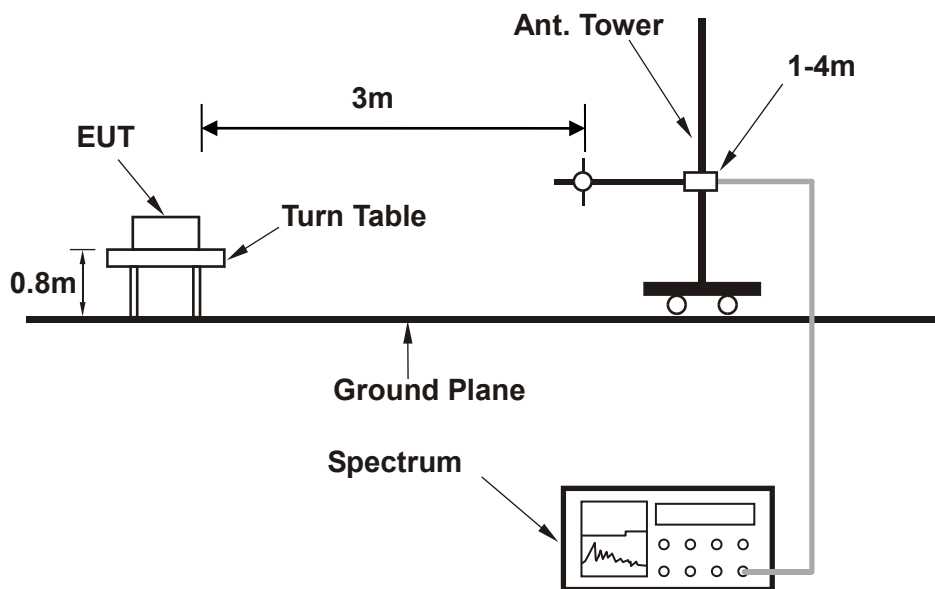

< Frequency Range above 1GHz >

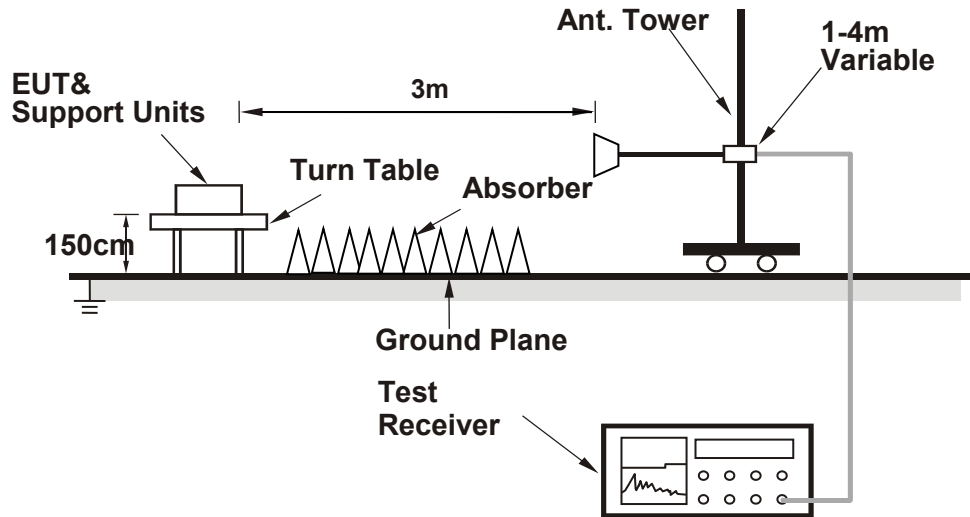

For the actual test configuration, please refer to the attached file (Test Setup Photo).



3.6.5 TEST RESULTS

NOTE : The 9K~30MHz amplitude of spurious emissions attenuated more than 20 dB below the permissible value is not required in the report.

BELOW 1GHz WORST-CASE DATA

30 MHz – 1GHz data:

LTE Band 14:

CHANNEL BANDWIDTH: 5MHz / QPSK

MODE	TX channel 23355	FREQUENCY RANGE	Below 1000MHz
ENVIRONMENTAL CONDITIONS	23deg. C, 70%RH	INPUT POWER	EUT 4.0V
TESTED BY	Jace HU		
ANTENNA POLARITY & TEST DISTANCE: HORIZONTAL AT 3 M			

	Read	Limit	Over			Remark	Pol/Phase
Freq	Level	Level	Line	Limit	Factor		
MHz	dBm/m	dBm	dBm/m	dB	dB/m		
1	62.980	-64.66	-45.18	-13.00	-51.66	-19.48 Peak	Horizontal
2	162.890	-65.66	-49.65	-13.00	-52.66	-16.01 Peak	Horizontal
3 PP	243.400	-61.66	-49.42	-13.00	-48.66	-12.24 Peak	Horizontal
4	423.820	-68.62	-59.02	-13.00	-55.62	-9.60 Peak	Horizontal
5	558.650	-65.37	-59.59	-13.00	-52.37	-5.78 Peak	Horizontal
6	756.530	-65.53	-61.84	-13.00	-52.53	-3.69 Peak	Horizontal

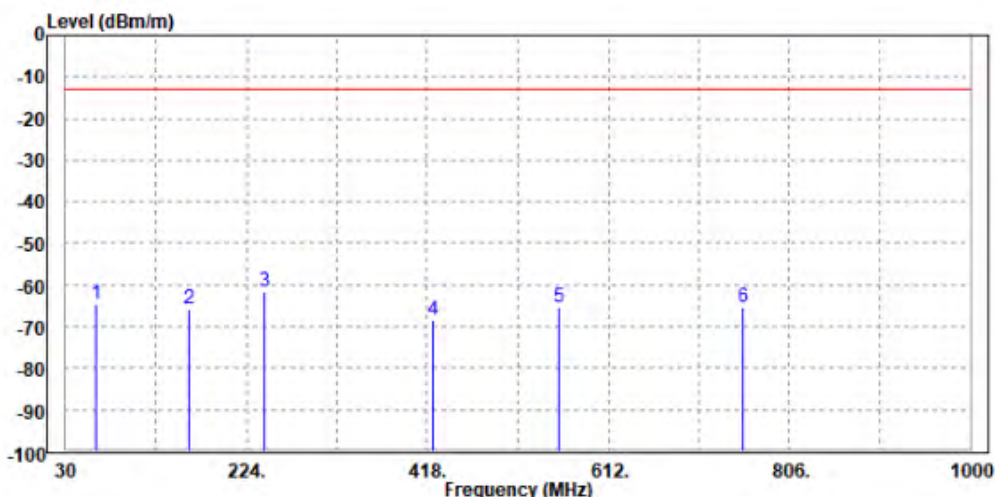



Test Report No.: W7L-P23030025RF08

MODE	TX channel 23355	FREQUENCY RANGE	Below 1000MHz
ENVIRONMENTAL CONDITIONS	23deg. C, 70%RH	INPUT POWER	EUT 4.0V
TESTED BY	Jace HU		
ANTENNA POLARITY & TEST DISTANCE: VERTICAL AT 3 M			

	Freq	Level	Read Level	Limit Line	Over Limit	Factor	Remark	Pol/Phase
	MHz	dBm/m	dBm	dBm/m	dB	dB/m		
1	75.590	-59.35	-38.64	-13.00	-46.35	-20.71	Peak	Vertical
2 PP	99.840	-57.89	-51.38	-13.00	-44.89	-6.51	Peak	Vertical
3	125.060	-62.00	-47.50	-13.00	-49.00	-14.50	Peak	Vertical
4	243.400	-64.50	-50.32	-13.00	-51.50	-14.18	Peak	Vertical
5	286.080	-64.73	-53.14	-13.00	-51.73	-11.59	Peak	Vertical
6	475.230	-64.93	-56.62	-13.00	-51.93	-8.31	Peak	Vertical

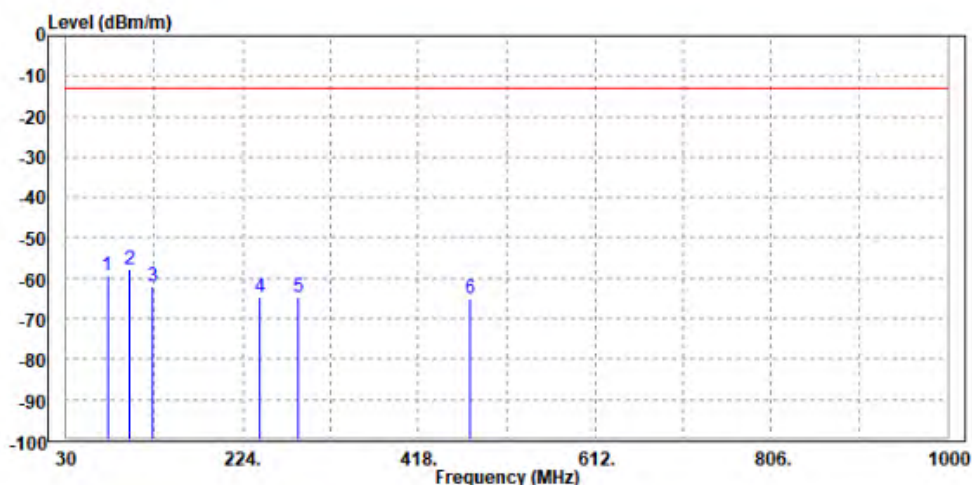



BUREAU
VERITAS

Test Report No.: W7L-P23030025RF08

ABOVE 1GHz

Note: For higher frequency, the emission is too low to be detected.

LTE BAND 14

CHANNEL BANDWIDTH: 5MHz / QPSK

CH23305

MODE	TX channel 23305	FREQUENCY RANGE	Above 1000MHz
ENVIRONMENTAL CONDITIONS	23deg. C, 70%RH	INPUT POWER	EUT 4.0V
TESTED BY	Jace Hu		
ANTENNA POLARITY & TEST DISTANCE: HORIZONTAL AT 3 M			

	Freq	Level	Read Level	Limit Line	Over Limit	Factor	Remark	Pol/Phase
	MHz	dBm/m	dBm	dBm/m	dB	dB/m		
1 PP	1581.000	-44.88	-45.11	-40.00	-4.88	0.23	Peak	Horizontal
2	2372.000	-52.54	-57.51	-13.00	-39.54	4.97	Peak	Horizontal

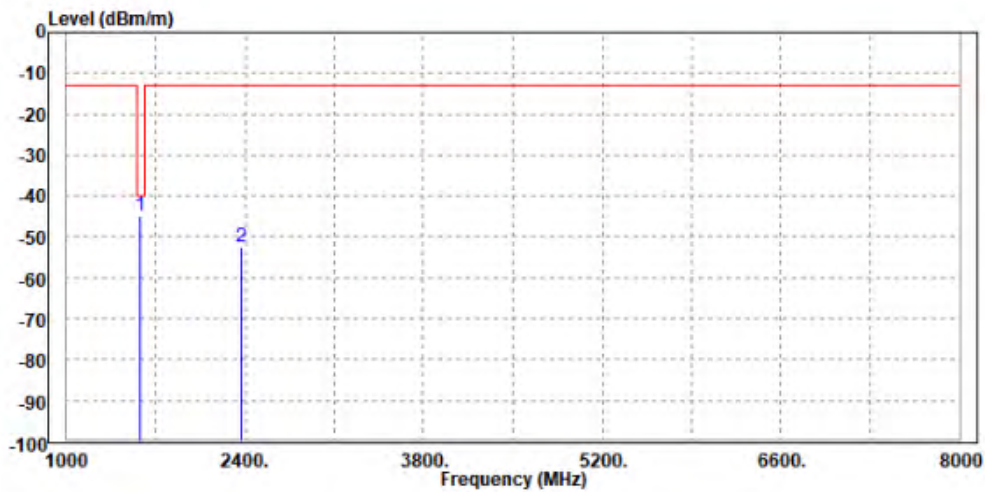



Test Report No.: W7L-P23030025RF08

MODE	TX channel 23305	FREQUENCY RANGE	Above 1000MHz
ENVIRONMENTAL CONDITIONS	23deg. C, 70%RH	INPUT POWER	EUT 4.0V
TESTED BY	Jace Hu		
ANTENNA POLARITY & TEST DISTANCE: VERTICAL AT 3 M			

	Freq	Level	Read Level	Limit Line	Over Limit	Factor	Remark	Pol/Phase
	MHz	dBm/m	dBm	dBm/m	dB	dB/m		
1	PP 1581.000	-45.21	-45.76	-40.00	-5.21	0.55	Peak	Vertical
2	2371.500	-53.10	-57.69	-13.00	-40.10	4.59	Peak	Vertical

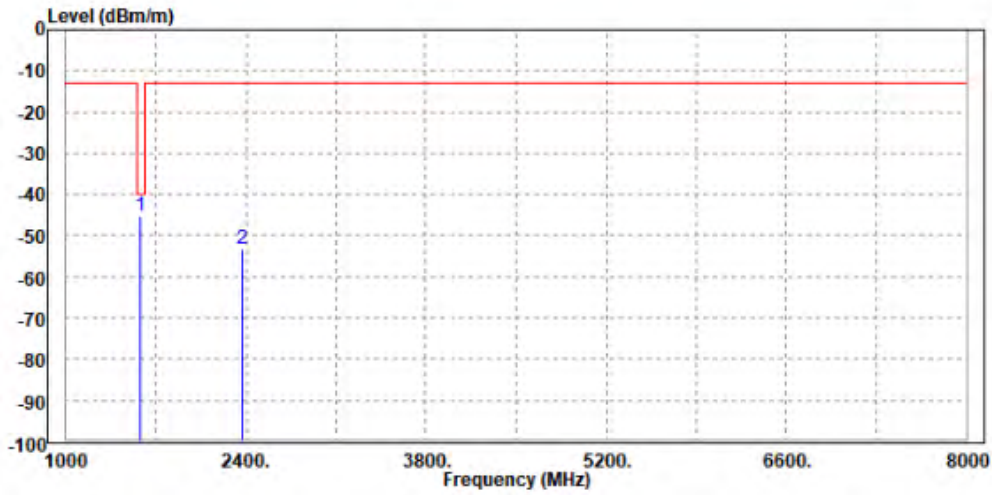



Test Report No.: W7L-P23030025RF08

CH23330

MODE	TX channel 23330	FREQUENCY RANGE	Above 1000MHz
ENVIRONMENTAL CONDITIONS	23deg. C, 70%RH	INPUT POWER	EUT 4.0V
TESTED BY	Jace Hu		
ANTENNA POLARITY & TEST DISTANCE: HORIZONTAL AT 3 M			

	Freq	Level	Read Level	Limit Line	Over Limit	Factor	Remark	Pol/Phase
	MHz	dBm/m	dBm	dBm/m	dB	dB/m		
1 PP	1588.000	-44.28	-44.57	-40.00	-4.28	0.29	Peak	Horizontal
2	2379.000	-52.31	-57.31	-13.00	-39.31	5.00	Peak	Horizontal

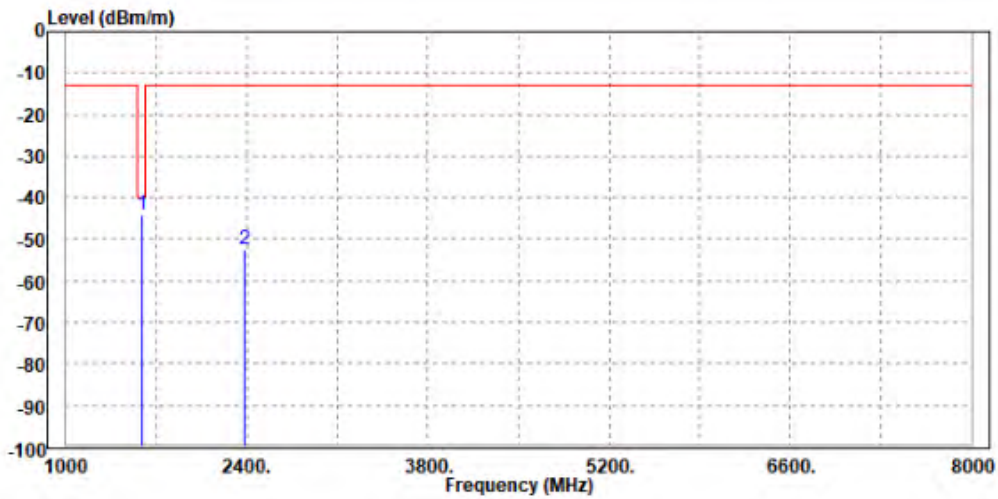



Test Report No.: W7L-P23030025RF08

MODE	TX channel 23330	FREQUENCY RANGE	Above 1000MHz
ENVIRONMENTAL CONDITIONS	23deg. C, 70%RH	INPUT POWER	EUT 4.0V
TESTED BY	Jace Hu		
ANTENNA POLARITY & TEST DISTANCE: VERTICAL AT 3 M			

	Freq	Level	Read Level	Limit	Over Limit	Factor	Remark	Pol/Phase
	MHz	dBm/m	dBm	dBm/m	dB	dB/m		
1	PP 1586.000	-45.75	-46.34	-40.00	-5.75	0.59	Peak	Vertical
2	2379.000	-54.09	-58.70	-13.00	-41.09	4.61	Peak	Vertical

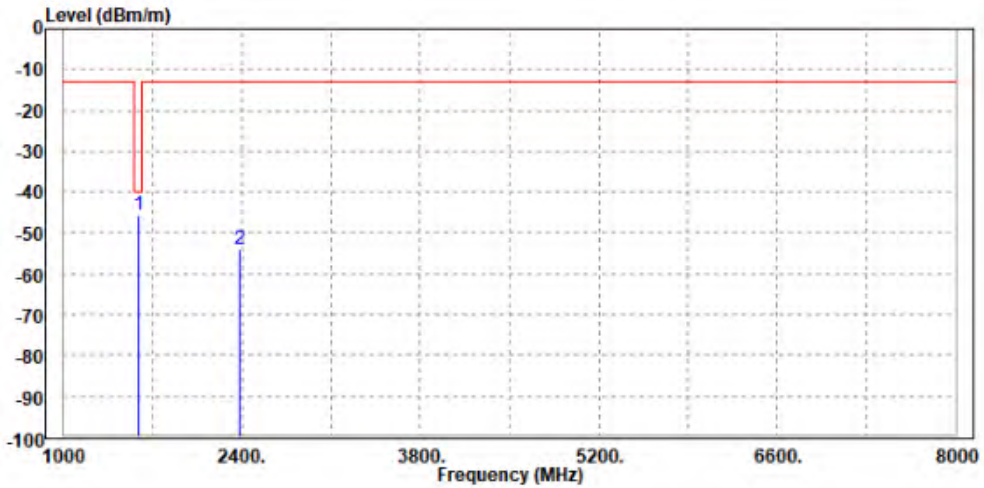



Test Report No.: W7L-P23030025RF08

CH23355

MODE	TX channel 23355	FREQUENCY RANGE	Above 1000MHz
ENVIRONMENTAL CONDITIONS	23deg. C, 70%RH	INPUT POWER	EUT 4.0V
TESTED BY	Jace Hu		
ANTENNA POLARITY & TEST DISTANCE: HORIZONTAL AT 3 M			

	Freq	Level	Read Level	Limit Line	Over Limit	Factor	Remark	Pol/Phase
	MHz	dBm/m	dBm	dBm/m	dB	dB/m		
1	PP 1588.000	-43.31	-43.60	-40.00	-3.31	0.29	Peak	Horizontal
2	2386.500	-49.71	-54.74	-13.00	-36.71	5.03	Peak	Horizontal

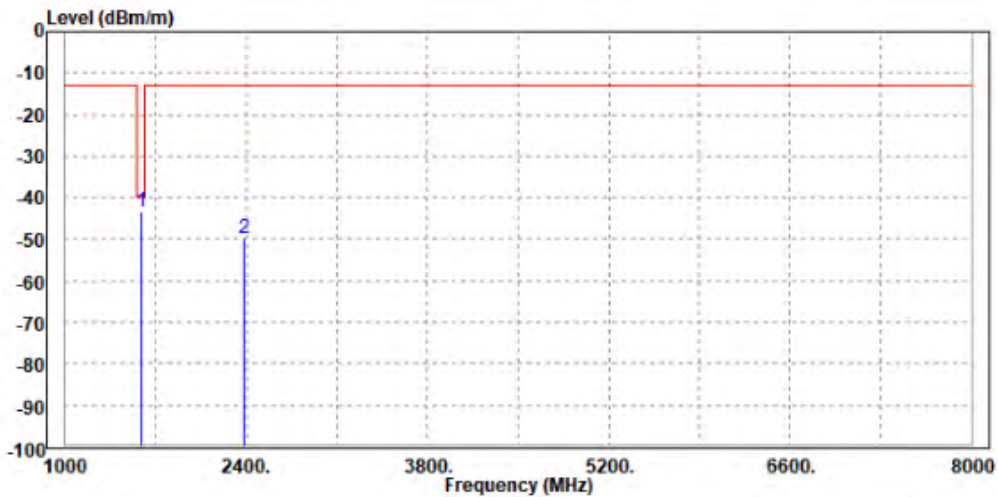



Test Report No.: W7L-P23030025RF08

MODE	TX channel 23355	FREQUENCY RANGE	Above 1000MHz
ENVIRONMENTAL CONDITIONS	23deg. C, 70%RH	INPUT POWER	EUT 4.0V
TESTED BY	Jace Hu		
ANTENNA POLARITY & TEST DISTANCE: VERTICAL AT 3 M			

	Freq	Level	Read Level	Limit Line	Over Limit	Factor	Remark	Pol/Phase
	MHz	dBm/m	dBm	dBm/m	dB	dB/m		
1 PP	1591.000	-44.74	-45.36	-40.00	-4.74	0.62	Peak	Vertical
2	2386.000	-51.05	-55.68	-13.00	-38.05	4.63	Peak	Vertical

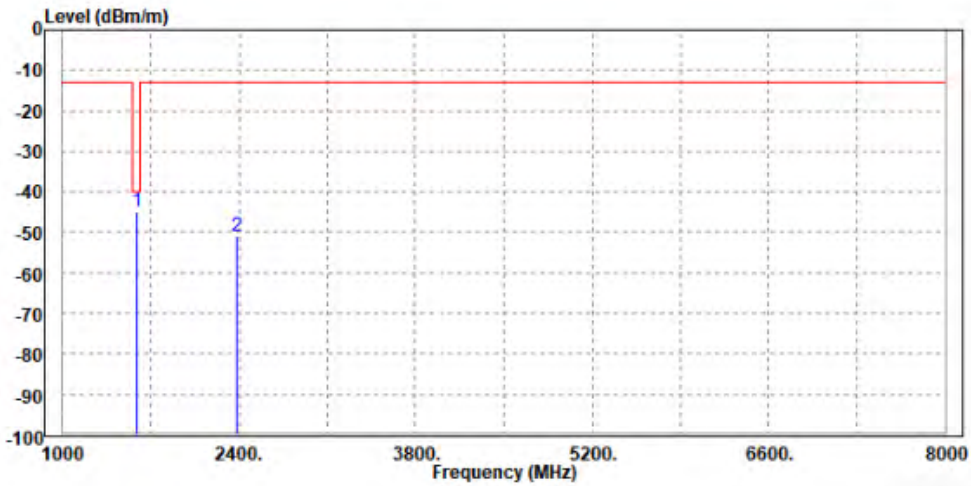



Test Report No.: W7L-P23030025RF08

CHANNEL BANDWIDTH: 10MHz / QPSK

CH23330

MODE	TX channel 23330	FREQUENCY RANGE	Above 1000MHz
ENVIRONMENTAL CONDITIONS	23deg. C, 70%RH	INPUT POWER	EUT 4.0V
TESTED BY	Jace Hu		
ANTENNA POLARITY & TEST DISTANCE: HORIZONTAL AT 3 M			

	Freq	Level	Read Level	Limit Line	Over Limit	Factor	Remark	Pol/Phase
	MHz	dBm/m	dBm	dBm/m	dB	dB/m		
1	PP 1586.000	-57.89	-58.16	-40.00	-17.89	0.27	Peak	Horizontal
2	2379.000	-53.32	-58.32	-13.00	-40.32	5.00	Peak	Horizontal

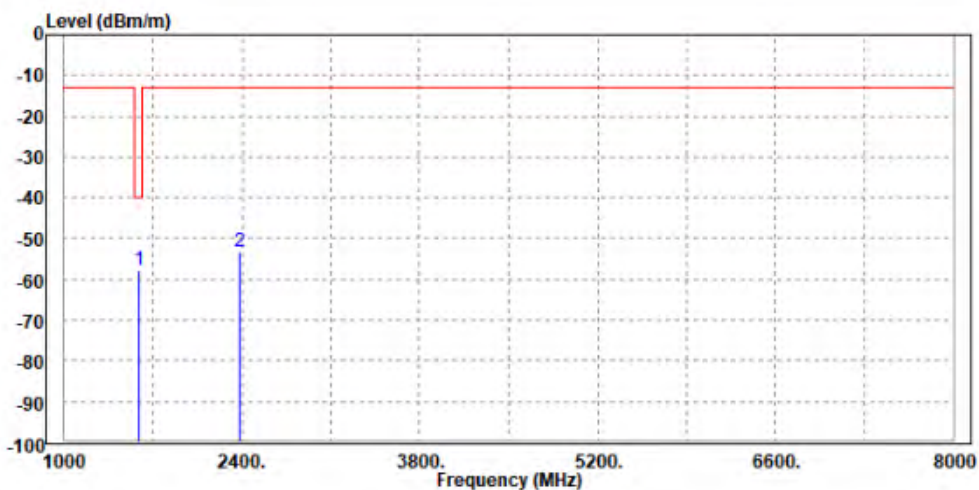



Test Report No.: W7L-P23030025RF08

MODE	TX channel 23330	FREQUENCY RANGE	Above 1000MHz
ENVIRONMENTAL CONDITIONS	23deg. C, 70%RH	INPUT POWER	EUT 4.0V
TESTED BY	Jace Hu		
ANTENNA POLARITY & TEST DISTANCE: VERTICAL AT 3 M			

	Freq	Level	Read Level	Limit	Over Limit	Factor	Remark	Pol/Phase
	MHz	dBm/m	dBm	dBm/m	dB	dB/m		
1	PP 1588.000	-57.96	-58.56	-40.00	-17.96	0.60	Peak	Vertical
2	2379.000	-53.90	-58.51	-13.00	-40.90	4.61	Peak	Vertical

