

*ACC*SOON

CineEye

5G Wireless Video Transmitter

User Manual

CineEye Wireless Video Transmitter

Introduction

CineEye is a revolution product, different from traditional video transmitters, the CineEye use the mobile devices as receiver and monitor.

CineEye can accept 1080p@60fps video input and transmit the video to the mobile devices through 5G WiFi, it offers real-time monitoring on up to 3 mobile devices at very low latency and the transmission range up to 100 meters in open areas.

As a transmission solution targeted for mobile devices, CineEye supports both Android & iOS platforms with state-of-the-art monitoring app that can turn your mobile devices into professional monitors, it offers many assisting features often seen on high-end monitors.

01 CineEye Diagram

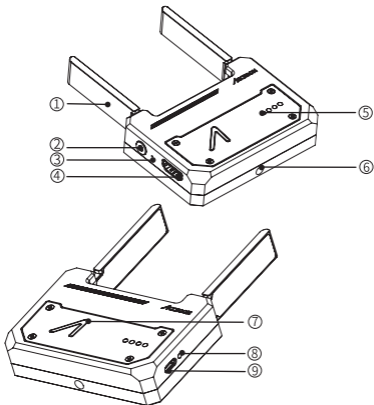

① Antenna

② Power Button

③ Reset Button

④ HDMI Input

⑤ Power LED

⑥ 1/4" Mounting Hole

⑦ Status LED

⑧ Charging LED

⑨ USB Type-C Charging Port

02 Charging

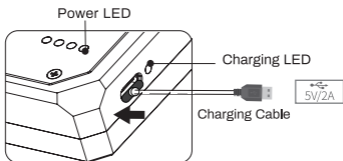

- While charging, the green led will blinking. When the battery is fully charged the green led will turn into solid.
- The CineEye support charging when in use.
- Please use 5V/2A charger or power bank for charging.
- For safety, charging will stop if the battery temperature higher than 45°C.

Power LED

Power LED State	Current Battery Level
● ● ● ●	75%-100%
● ● ●	50%-75%
● ●	25%-50%
●	2%-25%
Flashes quickly	Out of battery

03 Connection

Unfold the antenna

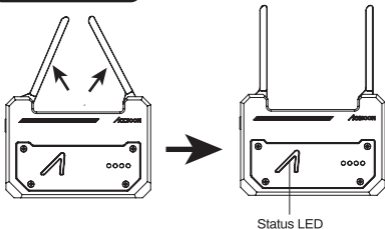

Connect HDMI

Connect the HDMI output from your video source to the HDMI input connector.

Status LED

Status led	Current level
White flashing	Starting
White solid	Working
Red flashing	Resetting
Red solid	No valid video input

04 Power On/Off and Reset

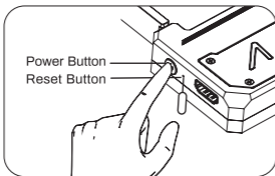

Power On

Press the power button for 1 second.

Power Off

1. Press the power button for 1 second.
2. No HDMI video stream input more than 10 minutes.
3. Out of battery.

Reset

Turn on the CineEye, then use a tiny tool to press the reset button for 3 second to perform complete factory reset.

05 APP

- 1.Launch the CineEye APP.Click “WiFi Setting” to open the WLAN page of the mobile devices,search and connect the CineEye WiFi (Name Format:CineEye_XXXX.initial password:12345678)
- 2.Back to the CineEye page,click “Into the Main”

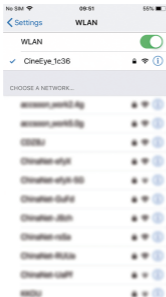

- 3.Click  to start monitoring.

 Some models of smart phones may need to turn off Mobile Data connection .or the CineEye APP cannot receive and display the image.

06 Warranty

Warranty Period

- 15-day warranty from the received date.If there any quality problem happening to our products,we will be responsible for giving free maintain or replace for free.
- The warranty time is one year.Within warranty period,if under the usage of instruction sheet,any product problems,we will offer the repair service for free.

Warranty Service Won't be given under the following circumstance

- Unauthorized maintenance,misusage,collision,liquid infiltration,modification.
- Incorrect use of the product,tearing up or altering label and flase proof mark.
- It has already exceeded the period of validity of 3-warranty.
- Damage due to fire,flood disaster,light storke and the like.

Process to get warranty service

Customer shall contact with the local dealer to solve the quality.If there is none,please contact with our company through E-mail(sales@accsoon.com) or our website(www.accsoon.com).You will get detailed information from them.We reserve the ultimate right to review the damaged products.

Product Name : 5G Wireless Video Transmitter

Product Model: WIT01

Serial number:

07 FCC Statement

This device complies with part 15 of the FCC rules. Operation is subject to the following two conditions (1) this device may not cause harmful interference, and (2) this device must accept any interference received, including interference that may cause undesired operation. Changes or modifications not expressly approved by the party responsible for compliance could void the user's authority to operate the equipment.

This equipment has been tested and found to comply with the limits for a Class B digital device, pursuant to Part 15 of the FCC Rules. These limits are designed to provide reasonable protection against harmful interference in a residential installation. This equipment generates uses and can radiate radio frequency energy and, if not installed and used in accordance with the instructions, may cause harmful interference to radio communications. However, there is no guarantee that interference will not occur in a particular installation. If this equipment does cause harmful interference to radio or television reception, which can be determined by turning the equipment off and on, the user is encouraged to try to correct the interference by one or more of the following measures:

- Reorient or relocate the receiving antenna.
- Increase the separation between the equipment and receiver.
- Connect the equipment into an outlet on a circuit different from that to which the receiver is connected.
- Consult the dealer or an experienced radio/TV technician for help

This equipment complies with FCC radiation exposure limits set forth for an uncontrolled environment. This equipment should be installed and operated with minimum distance 20cm between the radiator & your body.