

# Radio Test Report

Report No.: STS2310103W04

Issued for

Chengdu Accsoon Technology Co., LTD.

Rm. 2502, Bld. A, Tianxiang Plaza, Tianfu 2nd St., High-tech  
Zone, Chengdu, Sichuan, China

Product Name: Accsoon CineView Nano

Brand Name: Accsoon

Model Name: WIT04-M

Series Model(s): WIT04-N

FCC ID: 2AOH404WIT0M

Test Standards: FCC Part15.407

The test results presented in this report relate only to the object tested. This report shall not be reproduced, except in full, without the written approval of the ShenZhen STS Test Services Co., Ltd.



Table of Contents	Page
<b>1 . SUMMARY OF TEST RESULTS</b>	<b>6</b>
1.1 TEST FACTORY	7
1.2 MEASUREMENT UNCERTAINTY	7
<b>2 . GENERAL INFORMATION</b>	<b>8</b>
2.1 GENERAL DESCRIPTION OF THE EUT	8
2.2 DESCRIPTION OF TEST MODES	10
2.3 TEST SOFTWARE AND POWER LEVEL	11
2.4 BLOCK DIAGRAM SHOWING THE CONFIGURATION OF SYSTEM TESTED	12
2.5 DESCRIPTION OF NECESSARY ACCESSORIES AND SUPPORT UNITS	13
2.6 EQUIPMENTS LIST FOR ALL TEST ITEMS	14
<b>3 . EMC EMISSION TEST</b>	<b>15</b>
3.1 CONDUCTED EMISSION MEASUREMENT	15
3.2 RADIATED EMISSION AND ( BANDEDGE) MEASUREMENT	19
<b>4. POWER SPECTRAL DENSITY TEST</b>	<b>43</b>
4.1 LIMIT	43
4.2 TEST PROCEDURE	43
4.3 DEVIATION FROM STANDARD	44
4.4 TEST SETUP	44
4.5 EUT OPERATION CONDITIONS	44
4.6 TEST RESULTS	44
<b>5. BANDWIDTH MEASUREMENT</b>	<b>45</b>
5.1 EMISSION BANDWIDTH (EBW) 26 BANDWID PROCEDURES / LIMIT	45
5.2 OCCUPIED BANDWIDTH ( 99%) TEST APPLIED PROCEDURES / LIMIT	46
5.3 MINIMUM EMISSION BANDWIDTH(6 DB) PROCEDURES / LIMIT	47
<b>6. MAXIMUM CONDUCTED OUTPUT POWER</b>	<b>48</b>
6.1 LIMIT	48
6.2 TEST PROCEDURE	48
6.3 DEVIATION FROM STANDARD	48
6.4 TEST SETUP	48
6.5 EUT OPERATION CONDITIONS	48
6.6 TEST RESULTS	48
<b>7. AUTOMATICALLY DISCONTINUE TRANSMISSION</b>	<b>49</b>
7.1 LIMIT OF AUTOMATICALLY DISCONTINUE TRANSMISSION	49
7.2 TEST RESULT OF AUTOMATICALLY DISCONTINUE TRANSMISSION	49
<b>8. ANTENNA REQUIREMENT</b>	<b>50</b>



**Table of Contents**

	<b>Page</b>
8.1 STANDARD REQUIREMENT	50
8.2 EUT ANTENNA	50
<b>APPENDIX - PHOTOS OF TEST SETUP</b>	<b>51</b>



**Revision History**

Rev.	Issue Date	Report No.	Effect Page	Contents
00	14 Dec. 2023	STS2310103W04	ALL	Initial Issue



## 1. SUMMARY OF TEST RESULTS

Test procedures according to the technical standards:

§ 15.407, KDB 789033 D02 General U-NII Test Procedures New Rules v02r01

FCC Part 15.407		
FCC standard	Test Item	Results
15.207	AC Conducted Emission	PASS
15.407 (a) /15.407 (e)	26dB/6dB &99% Bandwidth	PASS
15.407(a)	Maximum Conducted Output Power	PASS
15.407(b)/15.205/15.209	Radiated Emission And (bandedge Emissions) Measurement	PASS
15.407(a)	Power Spectral Density	PASS
15.407(c)	Automatically Discontinue Transmission	PASS
15.203/15.204	Antenna Requirement	PASS

**NOTE:**

- (1) 'N/A' denotes test is not applicable in this Test Report.
- (2) All tests are according to ANSI C63.10-2013.



## 1.1 TEST FACTORY

SHENZHEN STS TEST SERVICES CO., LTD

Add. : 101, Building B, Zhuoke Science Park, No.190 Chongqing Road, ZhanChengShequ, Fuhai Sub-District, Bao'an District, Shenzhen, Guang Dong, China

FCC test Firm Registration Number: 625569

IC test Firm Registration Number: 12108A

A2LA Certificate No.: 4338.01

## 1.2 MEASUREMENT UNCERTAINTY

The reported uncertainty of measurement  $y \pm U$ , where expanded uncertainty  $U$  is based on a standard uncertainty multiplied by a coverage factor of  $k=2$ , providing a level of confidence of approximately **95 %**.

No.	Item	Uncertainty
1	RF output power, conducted	$\pm 1.197\text{dB}$
2	Unwanted Emissions, conducted	$\pm 2.896\text{dB}$
3	All emissions, radiated 9K-30MHz	$\pm 3.84\text{dB}$
4	All emissions, radiated 30M-1GHz	$\pm 3.94\text{dB}$
5	All emissions, radiated 1G-6GHz	$\pm 4.59\text{dB}$
6	All emissions, radiated >6G	$\pm 5.22\text{dB}$
7	Conducted Emission (9KHz-150KHz)	$\pm 2.14\text{dB}$
8	Conducted Emission (150KHz-30MHz)	$\pm 2.54\text{dB}$

## 2. GENERAL INFORMATION

### 2.1 GENERAL DESCRIPTION OF THE EUT

Product Name	Accsoon CineView Nano	
Brand Name	Accsoon	
Model Name	WIT04-M	
Series Model(s)	WIT04-N	
Model Difference	The color is different, everything else is the same	
Product Description	The EUT is a Accsoon CineView Nano	
	Operation Frequency:	IEEE 802.11n(HT20): 5.180GHz-5.240GHz
		IEEE 802.11 n(HT20):5.280GHz-5.320GHz
		IEEE 802.11 n(HT20):5.500GHz-5.700GHz
		IEEE 802.11 n(HT20):5.745GHz-5.825GHz
	Modulation Type:	802.11n(OFDM): BPSK,QPSK,16-QAM,64-QAM
	Antenna Type:	External antenna
	Antenna Gain (dBi):	ANT 1: 2.5 dBi ANT 2: 2.5 dBi MIMO 1+2: 5.51dBi
Max.Output Power(Conducted):	18.1 dBm	
More details of EUT technical specification, please refer to the User Manual.		
Test Channel	Please refer to the Note 3.	
Power Rating	Input: DC6.6-8.4V	
Hardware version number	V1.1	
Software version number	V1.28	
Connecting I/O Port(s)	Please refer to the Note 1.	

Note

1. For a more detailed features description, please refer to the manufacturer's specifications or the User Manual.
2. The antenna information refer the manufacturer provide report, applicable only to the tested sample identified in the report. Due to the incorrect antenna information, a series of problems such as the accuracy of the test results will be borne by the customer.



3. Operation Frequency of channel

5.180GHz-5.240GHz		5.500GHz-5.720GHz	
Channel	Frequency	Channel	Frequency
36	5180	100	5500
38	5190	102	5510
40	5200	104	5520
42	5210	106	5530
44	5220	108	5540
46	5230	110	5550
48	5240	112	5560
		116	5580
		118	5590
5.260GHz-5.320GHz			
Channel	Frequency		
52	5260	120	5600
54	5270	122	5610
56	5280	124	5620
58	5290	126	5630
60	5300	128	5640
62	5310	132	5660
64	5320	134	5670
		136	5680
		140	5700
5.745GHz-5.825GHz			
Channel	Frequency		
149	5745		
151	5755		
153	5765		
157	5785		
159	5795		
161	5805		
165	5825		

Note:

In section 15.31(m), regards to the operating frequency range over 10 MHz, the Lowest frequency, the middle frequency, and the highest frequency of channel were selected to perform the test, and the selected channel see below:

Carrier Frequency Channel

5GHz:

For 802.11n(HT20)			
Channel	Freq.(MHz)	Channel	Freq.(MHz)
36	5180	56	5280
40	5200	60	5300
48	5240	64	5320

For 802.11n(HT20)			
Channel	Freq.(MHz)	Channel	Freq.(MHz)
100	5500	149	5745
116	5580	157	5785
140	5700	165	5825



- 3. KDB 662911 D01 Multiple Transmitter Output v02r01
  - 2) Directional Gain Calculations for In-Band Measurements
    - a) Basic methodology with NANT transmit antennas, each with the same directional gain  $G_{ANT}$  dBi, being driven by NANT transmitter outputs of equal power. Directional gain is to be computed as follows:
      - (i) If any transmit signals are correlated with each other,  
Directional gain =  $G_{ANT} + 10 \log(NANT)$  dBi
      - (ii) If all transmit signals are completely uncorrelated with each other,  
Directional gain =  $G_{ANT}$

**2.2 DESCRIPTION OF TEST MODES**

To investigate the maximum EMI emission characteristics generates from EUT, the test system was pre-scanning tested base on the consideration of following EUT operation mode or test configuration mode which possible have effect on EMI emission level. Each of these EUT operation mode(s) or test configuration mode(s) mentioned above was evaluated respectively.

Worst Mode	Description	Data Rate
Mode 1	TX IEEE 802.11n HT20 CH36&CH40&CH48	MCS 0
Mode 2	TX IEEE 802.11n HT20 CH56&CH60&CH64	MCS 0
Mode 3	TX IEEE 802.11n HT20 CH100&CH116&CH140	MCS 0
Mode 4	TX IEEE 802.11n HT20 CH149&CH157&CH165	MCS 0

- Note: (1) The measurements are performed at the highest, middle, lowest available channels.  
 (2) The measurements are performed at all Bit Rate of Transmitter, the worst data was reported.  
 (3) We have be tested for all avaiable U.S. voltage and frequencies(For 120V,50/60Hz and 240V, 50/60Hz) for which the device is capable of operation.  
 (4) The battery is fully-charged during the radited and RF conducted test.

AC Conducted Emission

Test Case	
AC Conducted Emission	Mode 5: Keeping TX + WLAN Link

### 2.3 TEST SOFTWARE AND POWER LEVEL

During testing channel & power controlling software provided by the customer was used to control the operating channel as well as the output power level.

RF Function	Type	Mode Or Modulation type	ANT Gain(dBi)	ANT_1 Power Class	ANT_2 Power Class	Software For Testing
WIFI(5G)	U-NII-1 (5150MHz-5250MHz)	802.11n(HT20)	ANT 1: 2.5 ANT 2: 2.5 MIMO 1+2: 5.51	70	70	REALTEK 11ac 8822CU USB WLAN NIC Massproduction Kit
RF Function	Type	Mode Or Modulation type	ANT Gain(dBi)	ANT_1 Power Class	ANT_2 Power Class	Software For Testing
WIFI(5G)	U-NII-2A (5250MHz-5350MHz)	802.11n(HT20)	ANT 1: 2.5 ANT 2: 2.5 MIMO 1+2: 5.51	50	50	REALTEK 11ac 8822CU USB WLAN NIC Massproduction Kit
RF Function	Type	Mode Or Modulation type	ANT Gain(dBi)	ANT_1 Power Class	ANT_2 Power Class	Software For Testing
WIFI(5G)	U-NII-2C (5470MHz-5725MHz)	802.11n(HT20)	ANT 1: 2.5 ANT 2: 2.5 MIMO 1+2: 5.51	35	35	REALTEK 11ac 8822CU USB WLAN NIC Massproduction Kit
RF Function	Type	Mode Or Modulation type	ANT Gain(dBi)	ANT_1 Power Class	ANT_2 Power Class	Software For Testing
WIFI(5G)	U-NII-3 (5725MHz-5895MHz)	802.11n(HT20)	ANT 1: 2.5 ANT 2: 2.5 MIMO 1+2: 5.51	70	70	REALTEK 11ac 8822CU USB WLAN NIC Massproduction Kit

## 2.4 BLOCK DIAGRAM SHOWING THE CONFIGURATION OF SYSTEM TESTED

### Radiated Spurious Emission Test

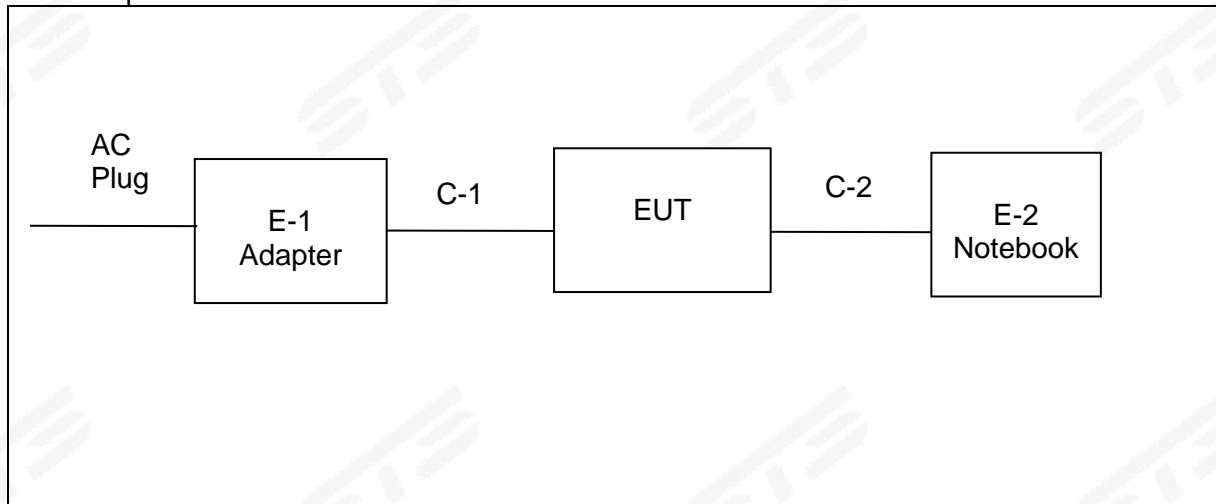

### Conducted Emission Test

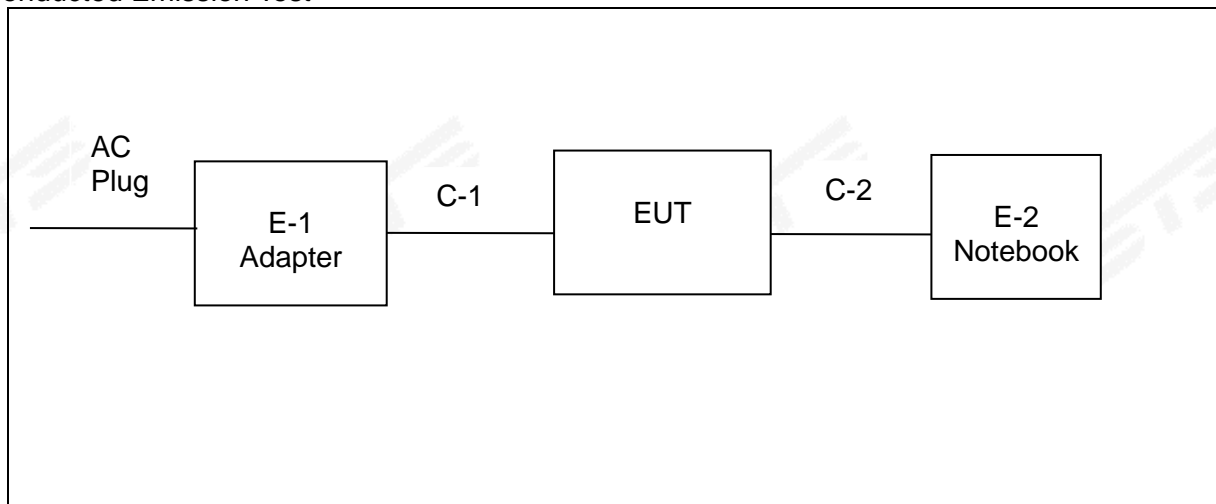

## 2.5 DESCRIPTION OF NECESSARY ACCESSORIES AND SUPPORT UNITS

The EUT has been tested as an independent unit together with other necessary accessories or support units. The following support units or accessories were used to form a representative test configuration during the tests.

### Necessary accessories

Item	Equipment	Mfr/Brand	Model/Type No.	Length	Note
N/A	N/A	N/A	N/A	N/A	N/A

### Support units

Item	Equipment	Mfr/Brand	Model/Type No.	Length	Note
	Adapter	HUAWEI	HW-050450C00	N/A	N/A
	USB Cable	N/A	N/A	110cm	NO
	DC Supply	HONGSHENGFENC	QJ6005E	N/A	N/A

Note:

- (1) For detachable type I/O cable should be specified the length in cm in 『Length』 column.

**2.6 EQUIPMENTS LIST FOR ALL TEST ITEMS**

<b>RF Radiation Test Equipment</b>					
<b>Kind of Equipment</b>	<b>Manufacturer</b>	<b>Type No.</b>	<b>Serial No.</b>	<b>Last Calibration</b>	<b>Calibrated Until</b>
Temperature & Humidity	SW-108	SuWei	N/A	2023.03.03	2024.03.02
Pre-Amplifier(0.1M-3GHz)	EM	EM330	060665	2023.02.28	2024.02.27
Pre-Amplifier(1G-18GHz)	SKET	LNPA-01018G-45	SK2018080901	2023.09.26	2024.09.25
Pre-Amplifier(18G-40GHz)	SKET	LNPA_1840-50	SK2018101801	2023.03.06	2024.03.05
Active loop Antenna	ZHINAN	ZN30900C	16035	2023.02.28	2024.02.27
Bilog Antenna	TESEQ	CBL6111D	34678	2022.09.30	2024.09.29
Horn Antenna	SCHWARZBECK	BBHA 9120D	02014	2023.09.24	2025.09.23
Horn Antenna	A-INFOMW	LB-180400-KF	J211020657	2023.10.10	2025.10.09
Positioning Controller	MF	MF-7802	MF-780208587	N/A	N/A
Signal Analyzer	R&S	FSV 40-N	101823	2023.09.26	2024.09.25
Switch Control Box	N/A	N/A	N/A	N/A	N/A
Filter Box	BALUN Technology	SU319E	BL-SZ1530051	N/A	N/A
Antenna Mast	MF	MFA-440H	N/A	N/A	N/A
Turn Table	MF	SC100_1	60531	N/A	N/A
AC Power Source	APC	KDF-11010G	F214050035	N/A	N/A
DC power supply	HONGSHENGFENG	DPS-305AF	17064939	2023.09.26	2024.09.25
Test SW	EZ-EMC	Ver.STSLAB-03A1 RE			
<b>Conduction Test equipment</b>					
<b>Kind of Equipment</b>	<b>Manufacturer</b>	<b>Type No.</b>	<b>Serial No.</b>	<b>Last calibration</b>	<b>Calibrated until</b>
Test Receiver	R&S	ESCI	101427	2023.09.25	2024.09.24
LISN	R&S	ENV216	101242	2023.09.25	2024.09.24
LISN	EMCO	3810/2NM	23625	2023.09.25	2024.09.24
Temperature & Humidity	SW-108	SuWei	N/A	2023.03.03	2024.03.02
Test SW	EZ-EMC	Ver.STSLAB-03A1 CE			
<b>RF Connected Test</b>					
<b>Kind of Equipment</b>	<b>Manufacturer</b>	<b>Type No.</b>	<b>Serial No.</b>	<b>Last calibration</b>	<b>Calibrated until</b>
Signal Analyzer	Agilent	N9020A	MY51510623	2023.03.01	2024.02.28
Power Sensor	Keysight	U2021XA	MY55520005	2023.09.26	2024.09.25
Temperature & Humidity	SW-108	SuWei	N/A	2023.03.03	2024.03.02
Test SW	MW	MTS 8310_2.0.0.0			

### 3. EMC EMISSION TEST

#### 3.1 CONDUCTED EMISSION MEASUREMENT

##### 3.1.1 POWER LINE CONDUCTED EMISSION Limits (Frequency Range 150KHz-30MHz)

FREQUENCY (MHz)	Class B (dBuV)		Standard
	Quasi-peak	Average	
0.15 -0.5	66 - 56 *	56 - 46 *	CISPR
0.50 -5.0	56.00	46.00	CISPR
5.0 -30.0	60.00	50.00	CISPR

0.15 -0.5	66 - 56 *	56 - 46 *	FCC
0.50 -5.0	56.00	46.00	FCC
5.0 -30.0	60.00	50.00	FCC

Note:

- (1) The tighter limit applies at the band edges.
- (2) The limit of “ \* ” marked band means the limitation decreases linearly with the logarithm of the frequency in the range.

The following table is the setting of the receiver

Receiver Parameters	Setting
Attenuation	10 dB
Start Frequency	0.15 MHz
Stop Frequency	30 MHz
IF Bandwidth	9 kHz

### 3.1.2 TEST PROCEDURE

- The EUT is 0.8 m from the horizontal ground plane and 0.4 m from the vertical ground plane with EUT being connected to the power mains through a line impedance stabilization network (LISN). All other support equipments are powered from additional LISN(s). The LISN provides 50 Ohm/ 50uH of coupling impedance for the measuring instrument.
- Interconnecting cables that hang closer than 40 cm to the ground plane shall be folded back and forth in the center forming a bundle 30 to 40 cm long.
- I/O cables that are not connected to a peripheral shall be bundled in the center. The end of the cable may be terminated, if required, using the correct terminating impedance. The overall length shall not exceed 1 m.
- LISN is at least 80 cm from the nearest part of EUT chassis.
- For the actual test configuration, please refer to the related Item –EUT Test Photos.

### 3.1.3 DEVIATION FROM TEST STANDARD

No deviation

### 3.1.4 TEST SETUP

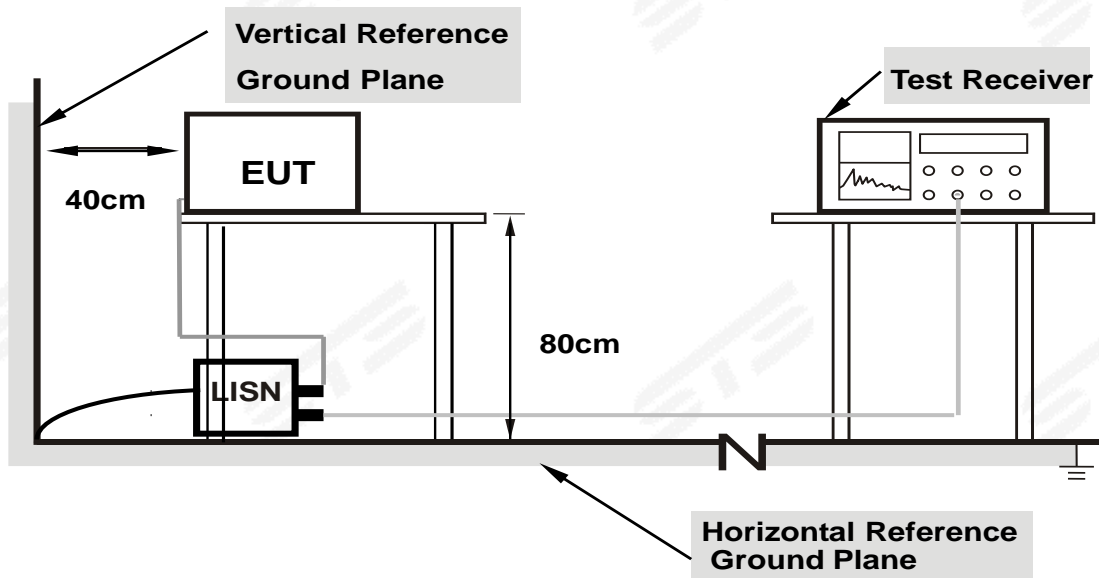

**Note: 1. Support units were connected to second LISN.**

- Both of LISNs (AMN) are 80 cm from EUT and at least 80 cm from other units and other metal planes support units.**

### 3.1.5 EUT OPERATING CONDITIONS

The EUT was configured for testing in a typical fashion (as a customer would normally use it). The EUT has been programmed to continuously transmit during test. This operating condition was tested and used to collect the included data.



### 3.1.6 TEST RESULTS

Temperature:	26.2(C)	Relative Humidity:	54%RH
Test Voltage:	AC 120V/60Hz	Phase:	L
Test Mode :	Mode 5		

No.	Frequency (MHz)	Reading (dBuV)	Correct Factor(dB)	Result (dBuV)	Limit (dBuV)	Margin (dB)	Remark
1	0.1540	28.38	19.74	48.12	65.78	-17.66	QP
2	0.1540	15.96	19.74	35.70	55.78	-20.08	AVG
3	0.5500	25.79	19.92	45.71	56.00	-10.29	QP
4	0.5500	15.37	19.92	35.29	46.00	-10.71	AVG
5	1.2540	28.99	19.78	48.77	56.00	-7.23	QP
6	1.2540	17.09	19.78	36.87	46.00	-9.13	AVG
7	2.8260	25.79	19.87	45.66	56.00	-10.34	QP
8	2.8260	11.22	19.87	31.09	46.00	-14.91	AVG
9	7.0820	25.85	19.88	45.73	60.00	-14.27	QP
10	7.0820	12.94	19.88	32.82	50.00	-17.18	AVG
11	23.1180	28.50	20.42	48.92	60.00	-11.08	QP
12	23.1180	14.01	20.42	34.43	50.00	-15.57	AVG

Remark:

1. All readings are Quasi-Peak and Average values
2. Margin = Result (Result =Reading + Factor )–Limit
3. Factor=LISN factor+Cable loss+Limiter (10dB)

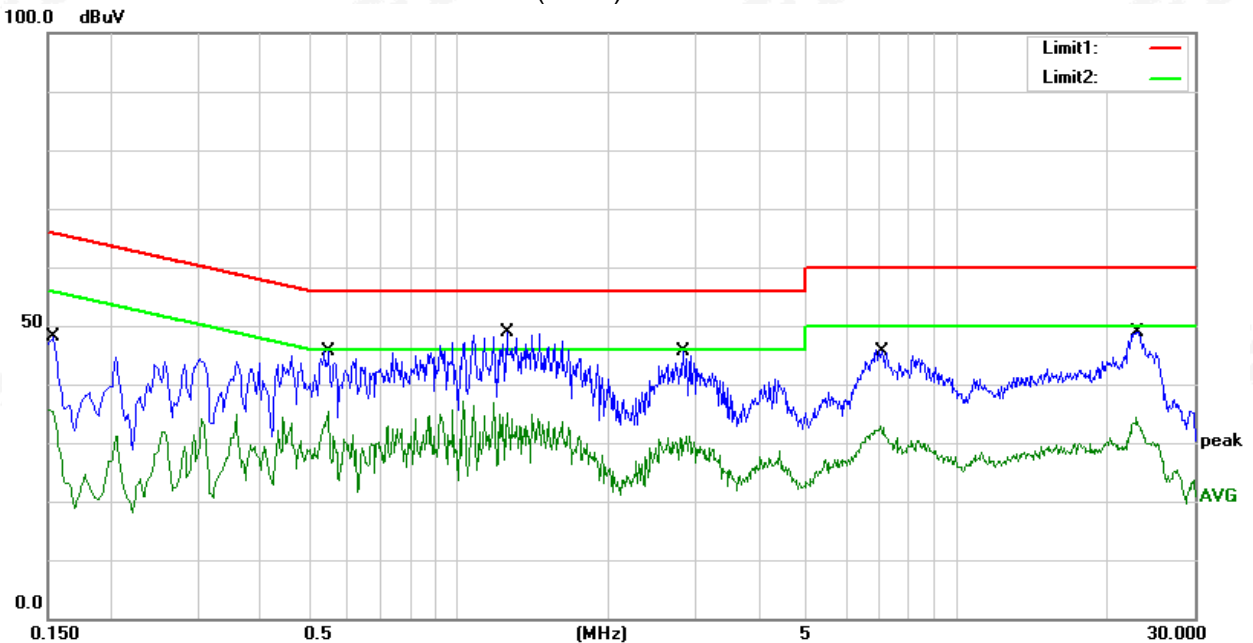



Temperature:	26.2(C)	Relative Humidity:	54%RH
Test Voltage	AC 120V/60Hz	Phase:	N
Test Mode	Mode 5		

No.	Frequency (MHz)	Reading (dBuV)	Correct Factor(dB)	Result (dBuV)	Limit (dBuV)	Margin (dB)	Remark
1	0.1500	27.45	19.73	47.18	66.00	-18.82	QP
2	0.1500	11.47	19.73	31.20	56.00	-24.80	AVG
3	0.5100	23.88	19.94	43.82	56.00	-12.18	QP
4	0.5100	10.93	19.94	30.87	46.00	-15.13	AVG
5	1.2700	27.76	19.78	47.54	56.00	-8.46	QP
6	1.2700	13.88	19.78	33.66	46.00	-12.34	AVG
7	2.6500	22.33	19.87	42.20	56.00	-13.80	QP
8	2.6500	9.37	19.87	29.24	46.00	-16.76	AVG
9	6.8900	25.53	19.87	45.40	60.00	-14.60	QP
10	6.8900	10.13	19.87	30.00	50.00	-20.00	AVG
11	22.3900	29.12	20.44	49.56	60.00	-10.44	QP
12	22.3900	12.73	20.44	33.17	50.00	-16.83	AVG

Remark:

- 1. All readings are Quasi-Peak and Average values
- 2. Margin = Result (Result =Reading + Factor )–Limit
- 3. Factor=LISN factor+Cable loss+Limiter (10dB)

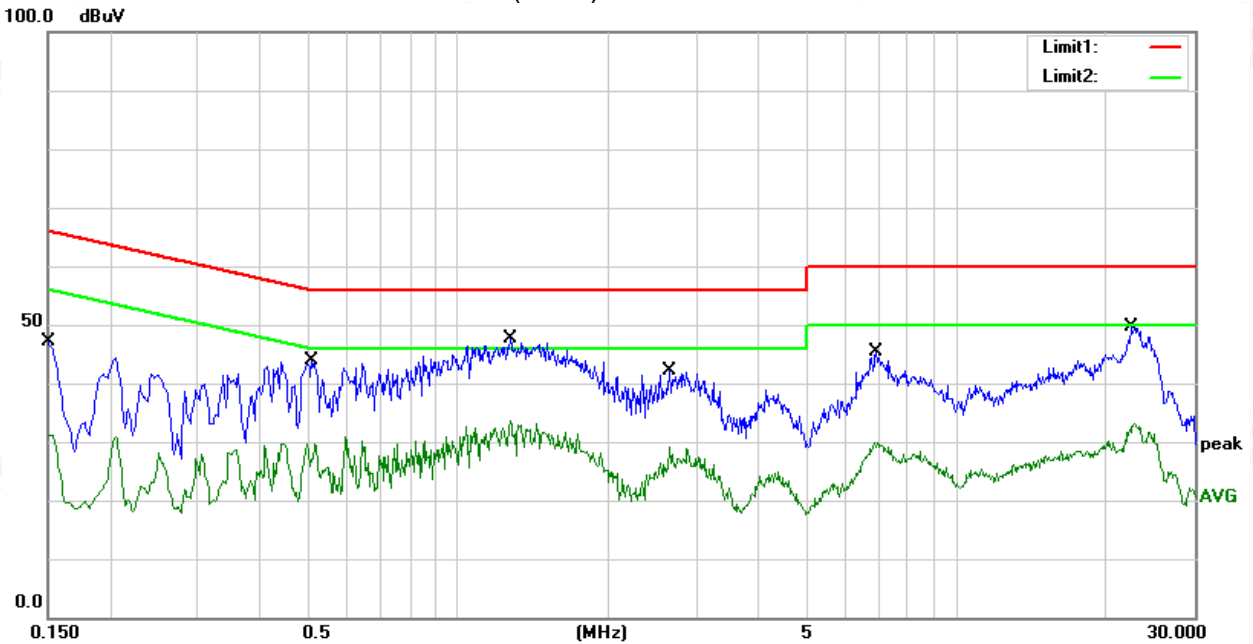

### 3.2 RADIATED EMISSION AND ( BANDEDGE) MEASUREMENT

#### 3.2.1 RADIATED EMISSION LIMITS (Frequency Range 9kHz-1000MHz)

In case the emission fall within the restricted band specified on 15.407(b)7&15.205/209(a), then the limit in the table below has to be followed.

Frequencies (MHz)	Field Strength (micorvolts/meter)	Measurement Distance (meters)
0.009~0.490	2400/F(KHz)	300
0.490~1.705	24000/F(KHz)	30
1.705~30.0	30	30
30~88	100	3
88~216	150	3
216~960	200	3
Above 960	500	3

#### LIMITS OF RADIATED EMISSION MEASUREMENT (Above 1000MHz)

FREQUENCY (MHz)	Class B (dBuV/m) (at 3M)	
	PEAK	AVERAGE
Above 1000	68.2	54

Notes:

- (1) The limit for radiated test was performed according to FCC PART 15E.
- (2) The tighter limit applies at the band edges.
- (3) Emission level (dBuV/m)=20log Emission level (uV/m).

#### LIMITS OF RESTRICTED FREQUENCY BANDS

FREQUENCY (MHz)	FREQUENCY (MHz)	FREQUENCY (MHz)	FREQUENCY (GHz)
0.090-0.110	16.42-16.423	399.9-410	4.5-5.15
0.495-0.505	16.69475-16.69525	608-614	5.35-5.46
2.1735-2.1905	16.80425-16.80475	960-1240	7.25-7.75
4.125-4.128	25.5-25.67	1300-1427	8.025-8.5
4.17725-4.17775	37.5-38.25	1435-1626.5	9.0-9.2
4.20725-4.20775	73-74.6	1645.5-1646.5	9.3-9.5
6.215-6.218	74.8-75.2	1660-1710	10.6-12.7
6.26775-6.26825	108-121.94	1718.8-1722.2	13.25-13.4
6.31175-6.31225	123-138	2200-2300	14.47-14.5
8.291-8.294	149.9-150.05	2310-2390	15.35-16.2
8.362-8.366	156.52475-156.52525	2483.5-2500	17.7-21.4
8.37625-8.38675	156.7-156.9	2690-2900	22.01-23.12
8.41425-8.41475	162.0125-167.17	3260-3267	23.6-24.0
12.29-12.293	167.72-173.2	3332-3339	31.2-31.8
12.51975-12.52025	240-285	3345.8-3358	36.43-36.5
12.57675-12.57725	322-335.4	3600-4400	Above 38.6
13.36-13.41			

Note: In case the emission radiated emission above 1000MHz fall within the restricted band the restricted frequency bands, the peak limit is 74 dBuV/m.

**LIMITS OF EMISSIONS OUTSIDE OF THE FREQUENCY BANDS**

Undesirable emission limits. Except as shown in paragraph (b)(7) of this section, the maximum emissions outside of the frequency bands of operation shall be attenuated in accordance with the following limits:

- (1) For transmitters operating in the 5.15-5.25 GHz band: All emissions outside of the 5.15-5.35 GHz band shall not exceed an e.i.r.p. of -27 dBm/MHz.
- (2) For transmitters operating in the 5.25-5.35 GHz band: All emissions outside of the 5.15-5.35 GHz band shall not exceed an e.i.r.p. of -27 dBm/MHz.
- (3) For transmitters operating in the 5.47-5.725 GHz band: All emissions outside of the 5.47-5.725 GHz band shall not exceed an e.i.r.p. of -27 dBm/MHz.
- (4) For transmitters operating in the 5.725-5.85 GHz band:
  - (i) All emissions shall be limited to a level of -27 dBm/MHz at 75 MHz or more above or below the band edge increasing linearly to 10 dBm/MHz at 25 MHz above or below the band edge, and from 25 MHz above or below the band edge increasing linearly to a level of 15.6 dBm/MHz at 5 MHz above or below the band edge, and from 5 MHz above or below the band edge increasing linearly to a level of 27 dBm/MHz at the band edge.

Note: dBuV/m(at 3M) = EIRP(dBm) + 95.2.

Peak Limit = -27dBm/MHz + 95.2 = 68.2 dBuV/m.

Spectrum Parameter	Setting
Attenuation	Auto
Detector	Peak
Start Frequency	1000 MHz(Peak/AV)
Stop Frequency	10th carrier harmonic (Peak/AV)
RB / VB (emission in restricted band)	1 MHz / 1 MHz, AV=1 MHz /3 MHz

For Band edge

Spectrum Parameter	Setting
Detector	Peak
RB / VB (emission in restricted band)	1 MHz / 1 MHz, AV=1 MHz /3 MHz

Receiver Parameter	Setting
Attenuation	Auto
Start ~ Stop Frequency	9kHz~90kHz / RB 200Hz for PK & AV
Start ~ Stop Frequency	90kHz~110kHz / RB 200Hz for QP
Start ~ Stop Frequency	110kHz~490kHz / RB 200Hz for PK & AV
Start ~ Stop Frequency	490kHz~30MHz / RB 9kHz for QP
Start ~ Stop Frequency	30MHz~1000MHz / RB 120kHz for QP

### 3.2.2 TEST PROCEDURE

- a. The measuring distance at 3 m shall be used for measurements at frequency 0.009MHz up to 1GHz, and above 1GHz.
- b. The EUT was placed on the top of a rotating table 0.8 m (above 1GHz is 1.5 m) above the ground at a 3 m anechoic chamber test site. The table was rotated 360 degree to determine the position of the highest radiation.
- c. The height of the equipment shall be 0.8 m (above 1GHz is 1.5 m); the height of the test antenna shall vary between 1 m to 4 m. Horizontal and vertical polarization of the antenna are set to make the measurement.
- d. The initial step in collecting conducted emission data is a spectrum analyzer peak detector mode pre-scanning the measurement frequency range. Significant peaks are then marked and QuasiPeak detector mode will be re-measured.
- e. If the Peak Mode measured value is compliance with and lower than Quasi Peak Mode Limit, the EUT shall be deemed to meet QP Limits and no additional QP Mode measurement was performed.
- f. For the actual test configuration, please refer to the related Item –EUT Test Photos.

Note:

Both horizontal and vertical antenna polarities were tested and performed pretest to three orthogonal axis. The worst case emissions were reported.

### 3.2.2 DEVIATION FROM TEST STANDARD

No deviation

### 3.2.3 TEST SETUP

#### (A) Radiated Emission Test-Up Frequency Below 30MHz

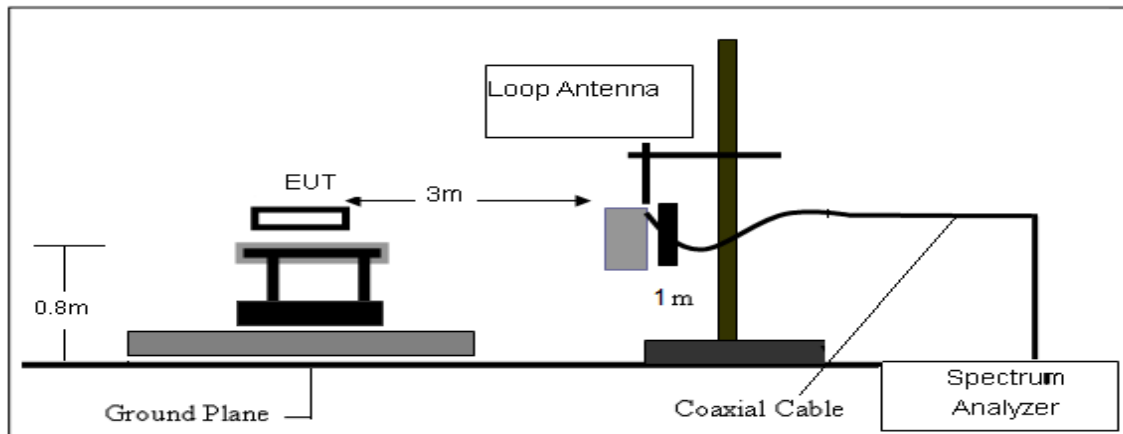

#### (B) Radiated Emission Test-Up Frequency 30MHz~1GHz

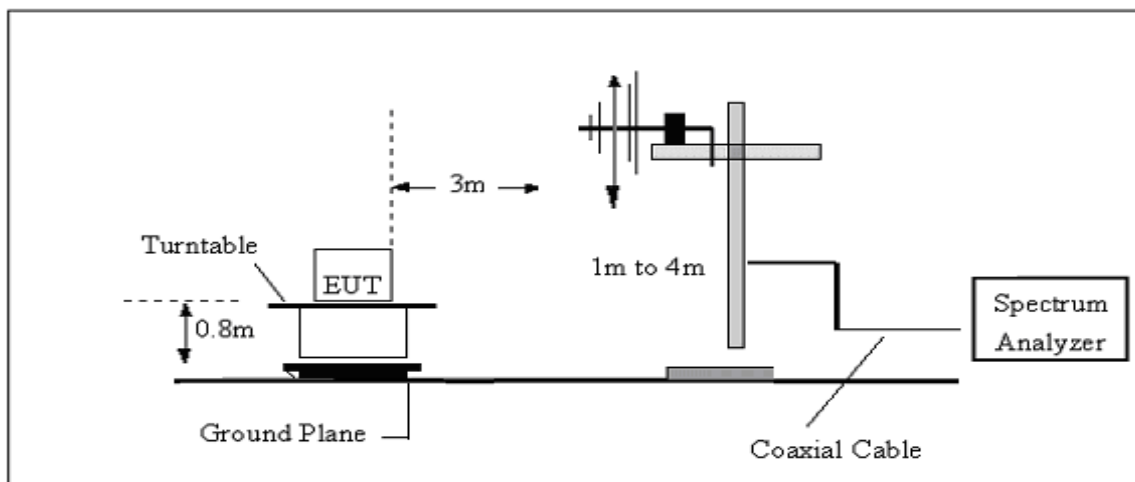

#### (C) Radiated Emission Test-Up Frequency Above 1GHz

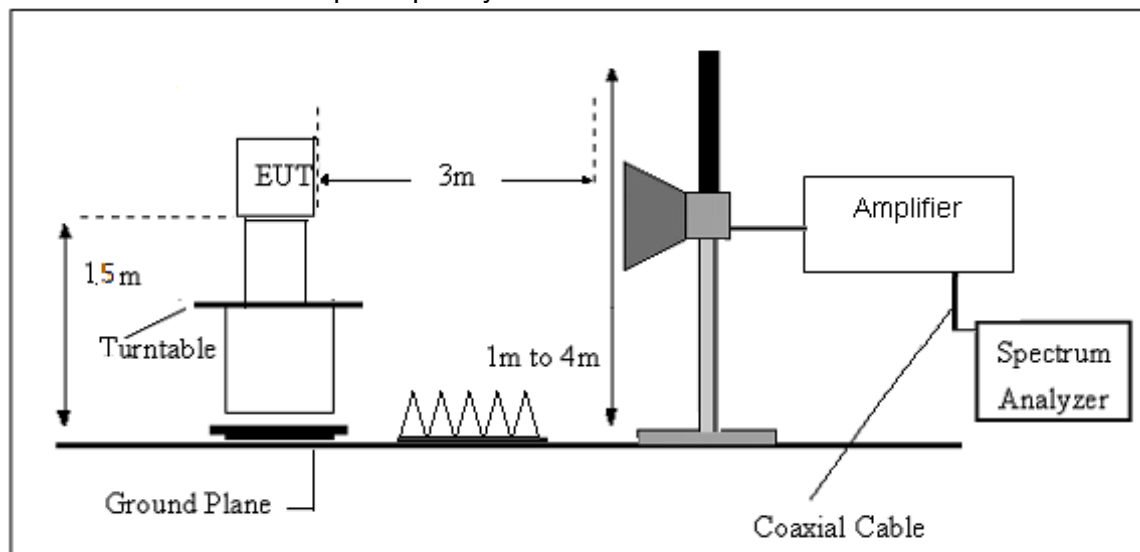

### 3.2.4 EUT OPERATING CONDITIONS

The EUT tested system was configured as the statements of 2.4 Unless otherwise a special operating condition is specified in the follows during the testing.

### 3.2.5 FIELD STRENGTH CALCULATION

The field strength is calculated by adding the Antenna Factor and Cable Factor and subtracting the Amplifier Gain and Duty Cycle Correction Factor (if any) from the measured reading. The basic equation with a sample calculation is as follows:

$$FS = RA + AF + CL - AG$$

Where

FS = Field Strength

CL = Cable Attenuation Factor (Cable Loss)

RA = Reading Amplitude

AG = Amplifier Gain

AF = Antenna Factor

For example

Frequency (MHz)	FS (dB $\mu$ V/m)	RA (dB $\mu$ V/m)	AF (dB)	CL (dB)	AG (dB)	Factor (dB)
300	40	58.1	12.2	1.6	31.9	-18.1

$$\text{Factor} = \text{AF} + \text{CL} - \text{AG}$$

**3.2.6 TEST RESULTS (Between 9KHz – 30 MHz)**

Temperature:	23.1(C)	Relative Humidity:	60%RH
Test Voltage:	DC 12V	Polarization :	--
Test Mode:	TX Mode		

Freq. (MHz)	Reading (dBuV/m)	Limit (dBuV/m)	Margin (dB)	State P/F
--	--	--	--	PASS
--	--	--	--	PASS

**Note:**

The amplitude of spurious emissions which are attenuated by more than 20dB below the permissible value has no need to be reported.

Distance extrapolation factor =  $40 \log(\text{specific distance}/\text{test distance})$ (dB);

Limit line = specific limits(dBuv) + distance extrapolation factor.



### 3.2.7 TEST RESULTS (Between 30MHz – 1GHz)

Temperature	23.1(C)	Relative Humidity:	60%RH
Test Voltage	DC 12V	Polarization:	Horizontal
Test Mode	Mode 1~4(Mode 1 worst mode)		

No.	Frequency (MHz)	Reading (dBuV)	Correct Factor(dB/m)	Result (dBuV/m)	Limit (dBuV/m)	Margin (dB)	Remark
1	30.0000	45.56	-12.85	32.71	40.00	-7.29	peak
2	102.7500	55.83	-19.84	35.99	43.50	-7.51	peak
3	181.3200	56.61	-20.11	36.50	43.50	-7.00	peak
4	390.8400	50.58	-11.54	39.04	46.00	-6.96	peak
5	499.4800	45.82	-8.02	37.80	46.00	-8.20	peak
6	763.3200	40.54	-2.22	38.32	46.00	-7.68	peak

Remark:

- Margin = Result (Result =Reading + Factor) –Limit
- Factor= Antenna factor+Cable attenuation factor(cable loss)-Amplifier gain

80.0 dBuV/m

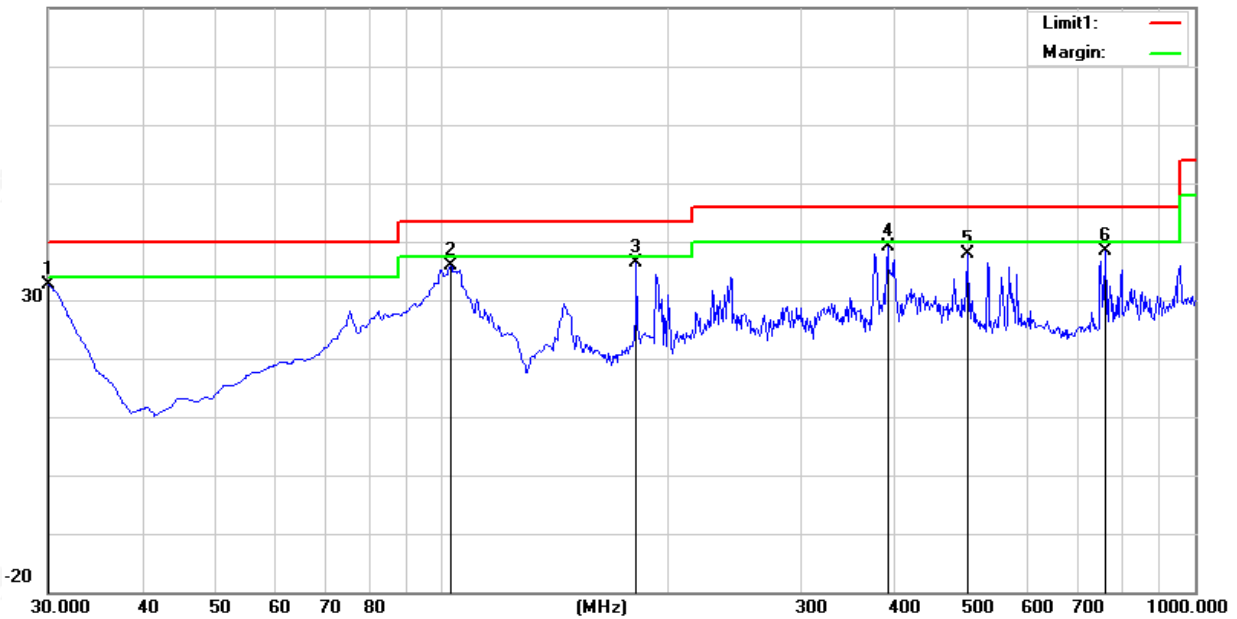



Temperature	23.1(C)	Relative Humidity:	60%RH
Test Voltage	DC 12V	Polarization:	Vertical
Test Mode	Mode 1~4(Mode 1 worst mode)		

No.	Frequency (MHz)	Reading (dBuV)	Correct Factor(dB/m)	Result (dBuV/m)	Limit (dBuV/m)	Margin (dB)	Remark
1	30.9700	45.47	-13.35	32.12	40.00	-7.88	peak
2	75.5900	54.39	-23.78	30.61	40.00	-9.39	peak
3	192.9600	58.21	-21.08	37.13	43.50	-6.37	peak
4	374.3500	51.72	-12.39	39.33	46.00	-6.67	peak
5	573.2000	40.56	-5.65	34.91	46.00	-11.09	peak
6	757.5000	41.39	-2.17	39.22	46.00	-6.78	peak

Remark:

- 1. Margin = Result (Result =Reading + Factor )-Limit
- 2. Factor= Antenna factor+Cable attenuation factor(cable loss)-Amplifier gain

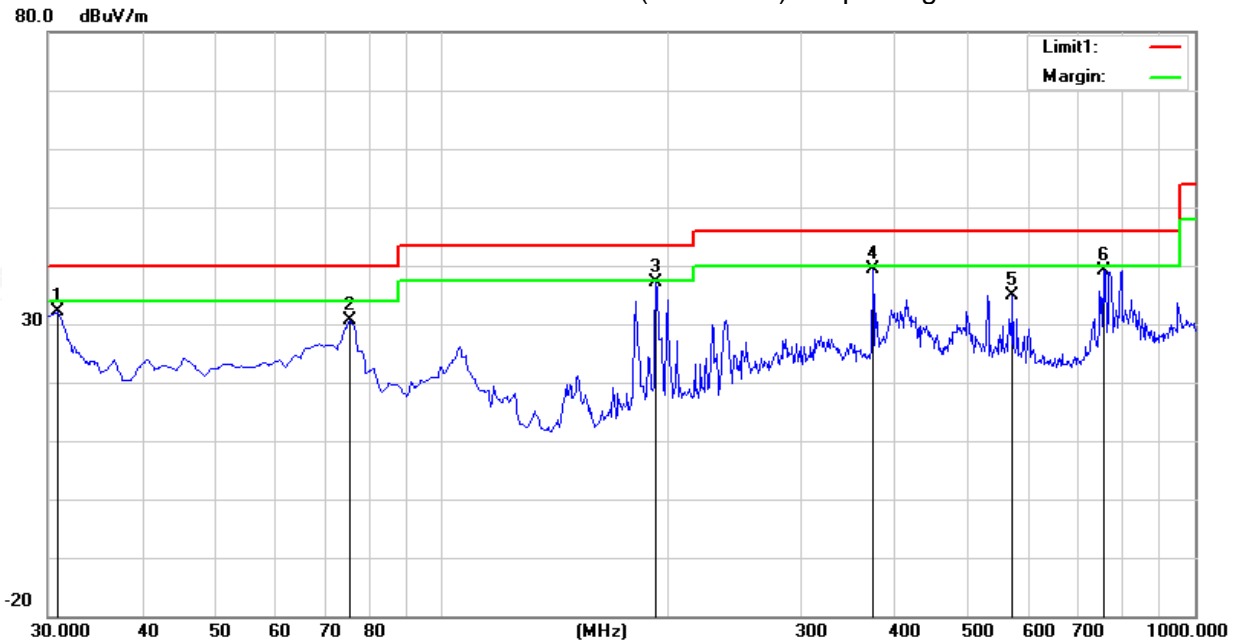



## 3.2.8 TEST RESULTS (Above 1000 MHz)

## U-NII-1 5150-5250MHz

U-NII 1										
Frequency (MHz)	Reading (dBuV)	Amplifier (dB)	Loss (dB)	Antenna Factor (dB/m)	Orrected Factor (dB)	Emission Level (dBuV/m)	Limit (dBuV/m)	Margin (dB)	Detector	Comment
Low Channel (802.11n20/ 5180 MHz)										
3263.17	43.80	44.70	6.70	28.20	-9.80	34.00	74.00	-40.00	Pk	Vertical
3263.17	41.51	44.70	6.70	28.20	-9.80	31.71	54.00	-22.29	AV	Vertical
3255.81	44.76	44.70	6.70	28.20	-9.80	34.96	68.20	-33.24	Pk	Horizontal
3255.81	41.18	44.70	6.70	28.20	-9.80	31.38	54.00	-22.62	AV	Horizontal
3985.33	40.05	44.20	7.90	29.70	-6.60	33.45	74.00	-40.55	Pk	Vertical
3985.33	36.40	44.20	7.90	29.70	-6.60	29.80	54.00	-24.20	AV	Vertical
3981.60	38.66	44.20	7.90	29.70	-6.60	32.06	74.00	-41.94	Pk	Horizontal
3981.60	36.50	44.20	7.90	29.70	-6.60	29.90	54.00	-24.10	AV	Horizontal
7218.20	36.52	43.50	11.40	35.50	3.40	39.92	68.20	-28.28	Pk	Vertical
7218.20	34.51	43.50	11.40	35.50	3.40	37.91	54.00	-16.09	AV	Vertical
7228.35	37.84	43.50	11.40	35.50	3.40	41.24	68.20	-26.96	Pk	Horizontal
7228.35	34.68	43.50	11.40	35.50	3.40	38.08	54.00	-15.92	AV	Horizontal
10359.97	38.75	44.50	13.80	38.80	8.10	46.85	68.20	-21.35	Pk	Vertical
10359.97	36.55	44.50	13.80	38.80	8.10	44.65	54.00	-9.35	AV	Vertical
10359.97	38.76	44.50	13.80	38.80	8.10	46.86	68.20	-21.34	Pk	Horizontal
10359.97	35.85	44.50	13.80	38.80	8.10	43.95	54.00	-10.05	AV	Horizontal
11026.04	34.04	43.60	14.30	39.50	10.20	44.24	74.00	-29.76	Pk	Vertical
11026.04	30.80	43.60	14.30	39.50	10.20	41.00	54.00	-13.00	AV	Vertical
11033.25	34.15	43.60	14.30	39.50	10.20	44.35	74.00	-29.65	Pk	Horizontal
11033.25	30.55	43.60	14.30	39.50	10.20	40.75	54.00	-13.25	AV	Horizontal
13298.77	31.54	42.60	15.90	38.90	12.20	43.74	74.00	-30.26	Pk	Vertical
13298.77	29.94	42.60	15.90	38.90	12.20	42.14	54.00	-11.86	AV	Vertical
13294.87	32.64	42.60	15.90	38.90	12.20	44.84	74.00	-29.16	Pk	Horizontal
13294.87	28.58	42.60	15.90	38.90	12.20	40.78	54.00	-13.22	AV	Horizontal
Mid Channel (802.11n20/ 5200 MHz)										
3262.53	45.09	44.70	6.70	28.20	-9.80	35.29	74.00	-38.71	Pk	Vertical
3262.53	41.30	44.70	6.70	28.20	-9.80	31.50	54.00	-22.50	AV	Vertical
3254.03	44.62	44.70	6.70	28.20	-9.80	34.82	68.20	-33.38	Pk	Horizontal
3254.03	41.88	44.70	6.70	28.20	-9.80	32.08	54.00	-21.92	AV	Horizontal
3996.09	39.86	44.20	7.90	29.70	-6.60	33.26	74.00	-40.74	Pk	Vertical
3996.09	35.69	44.20	7.90	29.70	-6.60	29.09	54.00	-24.91	AV	Vertical
3982.42	40.08	44.20	7.90	29.70	-6.60	33.48	74.00	-40.52	Pk	Horizontal
3982.42	36.04	44.20	7.90	29.70	-6.60	29.44	54.00	-24.56	AV	Horizontal
7220.39	37.51	43.50	11.40	35.50	3.40	40.91	68.20	-27.29	Pk	Vertical
7220.39	34.25	43.50	11.40	35.50	3.40	37.65	54.00	-16.35	AV	Vertical
7234.66	36.51	43.50	11.40	35.50	3.40	39.91	68.20	-28.29	Pk	Horizontal
7234.66	34.92	43.50	11.40	35.50	3.40	38.32	54.00	-15.68	AV	Horizontal
10400.23	39.62	44.50	13.80	38.80	8.10	47.72	68.20	-20.48	Pk	Vertical
10400.23	36.83	44.50	13.80	38.80	8.10	44.93	54.00	-9.07	AV	Vertical
10400.32	39.27	44.50	13.80	38.80	8.10	47.37	68.20	-20.83	Pk	Horizontal
10400.32	36.40	44.50	13.80	38.80	8.10	44.50	54.00	-9.50	AV	Horizontal
11034.09	33.71	43.60	14.30	39.50	10.20	43.91	74.00	-30.09	Pk	Vertical
11034.09	30.91	43.60	14.30	39.50	10.20	41.11	54.00	-12.89	AV	Vertical
11023.78	33.12	43.60	14.30	39.50	10.20	43.32	74.00	-30.68	Pk	Horizontal
11023.78	31.04	43.60	14.30	39.50	10.20	41.24	54.00	-12.76	AV	Horizontal
13285.50	32.20	42.60	15.90	38.90	12.20	44.40	74.00	-29.60	Pk	Vertical
13285.50	29.63	42.60	15.90	38.90	12.20	41.83	54.00	-12.17	AV	Vertical
13294.90	32.18	42.60	15.90	38.90	12.20	44.38	74.00	-29.62	Pk	Horizontal
13294.90	29.73	42.60	15.90	38.90	12.20	41.93	54.00	-12.07	AV	Horizontal



High Channel (802.11n20/ 5240 MHz)										
3249.86	44.17	44.70	6.70	28.20	-9.80	34.37	68.20	-33.83	Pk	Vertical
3249.86	42.08	44.70	6.70	28.20	-9.80	32.28	54.00	-21.72	AV	Vertical
3257.58	44.48	44.70	6.70	28.20	-9.80	34.68	68.20	-33.52	Pk	Horizontal
3257.58	41.44	44.70	6.70	28.20	-9.80	31.64	54.00	-22.36	AV	Horizontal
3990.95	38.87	44.20	7.90	29.70	-6.60	32.27	74.00	-41.73	Pk	Vertical
3990.95	36.82	44.20	7.90	29.70	-6.60	30.22	54.00	-23.78	AV	Vertical
3983.19	39.25	44.20	7.90	29.70	-6.60	32.65	74.00	-41.35	Pk	Horizontal
3983.19	35.78	44.20	7.90	29.70	-6.60	29.18	54.00	-24.82	AV	Horizontal
7225.90	36.80	43.50	11.40	35.50	3.40	40.20	68.20	-28.00	Pk	Vertical
7225.90	34.61	43.50	11.40	35.50	3.40	38.01	54.00	-15.99	AV	Vertical
7219.81	37.84	43.50	11.40	35.50	3.40	41.24	68.20	-26.96	Pk	Horizontal
7219.81	33.68	43.50	11.40	35.50	3.40	37.08	54.00	-16.92	AV	Horizontal
10480.04	39.70	44.50	13.80	38.80	8.10	47.80	68.20	-20.40	Pk	Vertical
10480.04	36.69	44.50	13.80	38.80	8.10	44.79	54.00	-9.21	AV	Vertical
10480.16	40.09	44.50	13.80	38.80	8.10	48.19	68.20	-20.01	Pk	Horizontal
10480.16	36.78	44.50	13.80	38.80	8.10	44.88	54.00	-9.12	AV	Horizontal
11032.36	33.05	43.60	14.30	39.50	10.20	43.25	74.00	-30.75	Pk	Vertical
11032.36	30.79	43.60	14.30	39.50	10.20	40.99	54.00	-13.01	AV	Vertical
11035.10	33.90	43.60	14.30	39.50	10.20	44.10	74.00	-29.90	Pk	Horizontal
11035.10	31.00	43.60	14.30	39.50	10.20	41.20	54.00	-12.80	AV	Horizontal
13293.49	31.62	42.60	15.90	38.90	12.20	43.82	74.00	-30.18	Pk	Vertical
13293.49	29.66	42.60	15.90	38.90	12.20	41.86	54.00	-12.14	AV	Vertical
13287.59	32.28	42.60	15.90	38.90	12.20	44.48	74.00	-29.52	Pk	Horizontal
13287.59	28.97	42.60	15.90	38.90	12.20	41.17	54.00	-12.83	AV	Horizontal

**Remark:**

1. Factor = Antenna Factor + Cable Loss – Pre-amplifier.
2. Scan with 802.11n (HT-20) all have been tested the antenna 1, antenna 2 and antenna 1+2, the worst case is 802.11n(HT20) of the antenna 1+2.
3. The frequency emission of peak points that did not show above the forms are at least 20dB below the limit, the frequency emission is mainly from the environment noise.



## U-NII-2A 5250-5350MHz

U-NII 2A										
Frequency (MHz)	Reading (dBuV)	Amplifier (dB)	Loss (dB)	Antenna Factor (dB/m)	Orrected Factor (dB)	Emission Level (dBuV/m)	Limit (dBuV/m)	Margin (dB)	Detector	Comment
Low Channel (802.11n20/ 5280 MHz)										
3248.92	44.82	44.70	6.70	28.20	-9.80	35.02	68.20	-33.18	Pk	Vertical
3248.92	41.59	44.70	6.70	28.20	-9.80	31.79	54.00	-22.21	AV	Vertical
3261.68	44.20	44.70	6.70	28.20	-9.80	34.40	74.00	-39.60	Pk	Horizontal
3261.68	41.62	44.70	6.70	28.20	-9.80	31.82	54.00	-22.18	AV	Horizontal
3987.86	39.86	44.20	7.90	29.70	-6.60	33.26	74.00	-40.74	Pk	Vertical
3987.86	37.15	44.20	7.90	29.70	-6.60	30.55	54.00	-23.45	AV	Vertical
3980.36	39.69	44.20	7.90	29.70	-6.60	33.09	74.00	-40.91	Pk	Horizontal
3980.36	35.99	44.20	7.90	29.70	-6.60	29.39	54.00	-24.61	AV	Horizontal
7226.28	37.89	43.50	11.40	35.50	3.40	41.29	68.20	-26.91	Pk	Vertical
7226.28	34.79	43.50	11.40	35.50	3.40	38.19	54.00	-15.81	AV	Vertical
7217.39	37.09	43.50	11.40	35.50	3.40	40.49	68.20	-27.71	Pk	Horizontal
7217.39	34.22	43.50	11.40	35.50	3.40	37.62	54.00	-16.38	AV	Horizontal
10360.13	39.22	44.50	13.80	38.80	8.10	47.32	68.20	-20.88	Pk	Vertical
10360.13	36.06	44.50	13.80	38.80	8.10	44.16	54.00	-9.84	AV	Vertical
10360.26	39.75	44.50	13.80	38.80	8.10	47.85	68.20	-20.35	Pk	Horizontal
10360.26	36.57	44.50	13.80	38.80	8.10	44.67	54.00	-9.33	AV	Horizontal
11025.16	33.15	43.60	14.30	39.50	10.20	43.35	74.00	-30.65	Pk	Vertical
11025.16	29.83	43.60	14.30	39.50	10.20	40.03	54.00	-13.97	AV	Vertical
11031.10	34.03	43.60	14.30	39.50	10.20	44.23	74.00	-29.77	Pk	Horizontal
11031.10	30.72	43.60	14.30	39.50	10.20	40.92	54.00	-13.08	AV	Horizontal
13297.65	31.83	42.60	15.90	38.90	12.20	44.03	74.00	-29.97	Pk	Vertical
13297.65	30.02	42.60	15.90	38.90	12.20	42.22	54.00	-11.78	AV	Vertical
13293.61	31.58	42.60	15.90	38.90	12.20	43.78	74.00	-30.22	Pk	Horizontal
13293.61	30.03	42.60	15.90	38.90	12.20	42.23	54.00	-11.77	AV	Horizontal
Mid Channel (802.11n20/ 5300 MHz)										
3261.48	45.02	44.70	6.70	28.20	-9.80	35.22	74.00	-38.78	Pk	Vertical
3261.48	41.83	44.70	6.70	28.20	-9.80	32.03	54.00	-21.97	AV	Vertical
3253.65	44.30	44.70	6.70	28.20	-9.80	34.50	68.20	-33.70	Pk	Horizontal
3253.65	41.24	44.70	6.70	28.20	-9.80	31.44	54.00	-22.56	AV	Horizontal
3996.80	39.63	44.20	7.90	29.70	-6.60	33.03	74.00	-40.97	Pk	Vertical
3996.80	36.55	44.20	7.90	29.70	-6.60	29.95	54.00	-24.05	AV	Vertical
3985.81	40.04	44.20	7.90	29.70	-6.60	33.44	74.00	-40.56	Pk	Horizontal
3985.81	36.40	44.20	7.90	29.70	-6.60	29.80	54.00	-24.20	AV	Horizontal
7228.81	37.90	43.50	11.40	35.50	3.40	41.30	68.20	-26.90	Pk	Vertical
7228.81	34.55	43.50	11.40	35.50	3.40	37.95	54.00	-16.05	AV	Vertical
7219.40	37.69	43.50	11.40	35.50	3.40	41.09	68.20	-27.11	Pk	Horizontal
7219.40	34.55	43.50	11.40	35.50	3.40	37.95	54.00	-16.05	AV	Horizontal
10400.12	39.95	44.50	13.80	38.80	8.10	48.05	68.20	-20.15	Pk	Vertical
10400.12	35.83	44.50	13.80	38.80	8.10	43.93	54.00	-10.07	AV	Vertical
10400.35	38.69	44.50	13.80	38.80	8.10	46.79	68.20	-21.41	Pk	Horizontal
10400.35	36.72	44.50	13.80	38.80	8.10	44.82	54.00	-9.18	AV	Horizontal
11031.83	34.10	43.60	14.30	39.50	10.20	44.30	74.00	-29.70	Pk	Vertical
11031.83	30.24	43.60	14.30	39.50	10.20	40.44	54.00	-13.56	AV	Vertical
11019.34	33.04	43.60	14.30	39.50	10.20	43.24	74.00	-30.76	Pk	Horizontal
11019.34	30.84	43.60	14.30	39.50	10.20	41.04	54.00	-12.96	AV	Horizontal
13293.43	31.98	42.60	15.90	38.90	12.20	44.18	74.00	-29.82	Pk	Vertical
13293.43	28.66	42.60	15.90	38.90	12.20	40.86	54.00	-13.14	AV	Vertical
13298.65	32.23	42.60	15.90	38.90	12.20	44.43	74.00	-29.57	Pk	Horizontal
13298.65	29.34	42.60	15.90	38.90	12.20	41.54	54.00	-12.46	AV	Horizontal



High Channel (802.11n20/ 5320 MHz)										
3259.48	43.83	44.70	6.70	28.20	-9.80	34.03	68.20	-34.17	Pk	Vertical
3259.48	41.80	44.70	6.70	28.20	-9.80	32.00	54.00	-22.00	AV	Vertical
3248.09	44.87	44.70	6.70	28.20	-9.80	35.07	68.20	-33.13	Pk	Horizontal
3248.09	41.56	44.70	6.70	28.20	-9.80	31.76	54.00	-22.24	AV	Horizontal
3993.51	39.21	44.20	7.90	29.70	-6.60	32.61	74.00	-41.39	Pk	Vertical
3993.51	36.98	44.20	7.90	29.70	-6.60	30.38	54.00	-23.62	AV	Vertical
3983.54	38.68	44.20	7.90	29.70	-6.60	32.08	74.00	-41.92	Pk	Horizontal
3983.54	35.97	44.20	7.90	29.70	-6.60	29.37	54.00	-24.63	AV	Horizontal
7222.89	36.73	43.50	11.40	35.50	3.40	40.13	68.20	-28.07	Pk	Vertical
7222.89	34.37	43.50	11.40	35.50	3.40	37.77	54.00	-16.23	AV	Vertical
7221.23	37.30	43.50	11.40	35.50	3.40	40.70	68.20	-27.50	Pk	Horizontal
7221.23	34.81	43.50	11.40	35.50	3.40	38.21	54.00	-15.79	AV	Horizontal
10480.18	39.94	44.50	13.80	38.80	8.10	48.04	68.20	-20.16	Pk	Vertical
10480.18	36.54	44.50	13.80	38.80	8.10	44.64	54.00	-9.36	AV	Vertical
10480.44	39.67	44.50	13.80	38.80	8.10	47.77	68.20	-20.43	Pk	Horizontal
10480.44	36.39	44.50	13.80	38.80	8.10	44.49	54.00	-9.51	AV	Horizontal
11024.56	33.99	43.60	14.30	39.50	10.20	44.19	74.00	-29.81	Pk	Vertical
11024.56	30.19	43.60	14.30	39.50	10.20	40.39	54.00	-13.61	AV	Vertical
11019.66	33.14	43.60	14.30	39.50	10.20	43.34	74.00	-30.66	Pk	Horizontal
11019.66	30.74	43.60	14.30	39.50	10.20	40.94	54.00	-13.06	AV	Horizontal
13285.31	33.01	42.60	15.90	38.90	12.20	45.21	74.00	-28.79	Pk	Vertical
13285.31	29.84	42.60	15.90	38.90	12.20	42.04	54.00	-11.96	AV	Vertical
13298.52	32.33	42.60	15.90	38.90	12.20	44.53	74.00	-29.47	Pk	Horizontal
13298.52	29.82	42.60	15.90	38.90	12.20	42.02	54.00	-11.98	AV	Horizontal

**Remark:**

1. Factor = Antenna Factor + Cable Loss – Pre-amplifier.
2. Scan with 802.11n (HT-20) all have been tested the antenna 1, antenna 2 and antenna 1+2, the worst case is 802.11n(HT20) of the antenna 1+2.
3. The frequency emission of peak points that did not show above the forms are at least 20dB below the limit, the frequency emission is mainly from the environment noise.



## U-NII-2C 5470-5725MHz

Frequency (MHz)	Reading (dBuV)	Amplifier (dB)	Loss (dB)	Antenna Factor (dB/m)	Orrected Factor (dB)	Emission Level (dBuV/m)	Limit (dBuV/m)	Margin (dB)	Detector	Comment
Low Channel (802.11n20/ 5500 MHz)										
3245.44	44.03	44.70	6.70	28.20	-9.80	34.23	68.20	-33.97	Pk	Vertical
3245.44	41.57	44.70	6.70	28.20	-9.80	31.77	54.00	-22.23	AV	Vertical
3253.55	44.68	44.70	6.70	28.20	-9.80	34.88	68.20	-33.32	Pk	Horizontal
3253.55	41.54	44.70	6.70	28.20	-9.80	31.74	54.00	-22.26	AV	Horizontal
3984.30	38.75	44.20	7.90	29.70	-6.60	32.15	74.00	-41.85	Pk	Vertical
3984.30	36.87	44.20	7.90	29.70	-6.60	30.27	54.00	-23.73	AV	Vertical
3986.68	39.40	44.20	7.90	29.70	-6.60	32.80	74.00	-41.20	Pk	Horizontal
3986.68	36.39	44.20	7.90	29.70	-6.60	29.79	54.00	-24.21	AV	Horizontal
7221.90	36.50	43.50	11.40	35.50	3.40	39.90	68.20	-28.30	Pk	Vertical
7221.90	34.58	43.50	11.40	35.50	3.40	37.98	54.00	-16.02	AV	Vertical
7232.20	37.13	43.50	11.40	35.50	3.40	40.53	68.20	-27.67	Pk	Horizontal
7232.20	34.13	43.50	11.40	35.50	3.40	37.53	54.00	-16.47	AV	Horizontal
10360.05	39.87	44.50	13.80	38.80	8.10	47.97	68.20	-20.23	Pk	Vertical
10360.05	35.87	44.50	13.80	38.80	8.10	43.97	54.00	-10.03	AV	Vertical
10360.33	39.36	44.50	13.80	38.80	8.10	47.46	68.20	-20.74	Pk	Horizontal
10360.33	37.00	44.50	13.80	38.80	8.10	45.10	54.00	-8.90	AV	Horizontal
11025.82	33.64	43.60	14.30	39.50	10.20	43.84	74.00	-30.16	Pk	Vertical
11025.82	30.93	43.60	14.30	39.50	10.20	41.13	54.00	-12.87	AV	Vertical
11018.59	33.23	43.60	14.30	39.50	10.20	43.43	74.00	-30.57	Pk	Horizontal
11018.59	30.01	43.60	14.30	39.50	10.20	40.21	54.00	-13.79	AV	Horizontal
13280.68	31.95	42.60	15.90	38.90	12.20	44.15	74.00	-29.85	Pk	Vertical
13280.68	29.17	42.60	15.90	38.90	12.20	41.37	54.00	-12.63	AV	Vertical
13298.04	31.63	42.60	15.90	38.90	12.20	43.83	74.00	-30.17	Pk	Horizontal
13298.04	29.93	42.60	15.90	38.90	12.20	42.13	54.00	-11.87	AV	Horizontal
Mid Channel (802.11n20/ 5580 MHz)										
3248.32	44.79	44.70	6.70	28.20	-9.80	34.99	68.20	-33.21	Pk	Vertical
3248.32	41.48	44.70	6.70	28.20	-9.80	31.68	54.00	-22.32	AV	Vertical
3245.68	44.07	44.70	6.70	28.20	-9.80	34.27	68.20	-33.93	Pk	Horizontal
3245.68	41.14	44.70	6.70	28.20	-9.80	31.34	54.00	-22.66	AV	Horizontal
4000.27	38.87	44.20	7.90	29.70	-6.60	32.27	74.00	-41.73	Pk	Vertical
4000.27	36.47	44.20	7.90	29.70	-6.60	29.87	54.00	-24.13	AV	Vertical
3999.33	39.56	44.20	7.90	29.70	-6.60	32.96	74.00	-41.04	Pk	Horizontal
3999.33	36.17	44.20	7.90	29.70	-6.60	29.57	54.00	-24.43	AV	Horizontal
7223.01	36.75	43.50	11.40	35.50	3.40	40.15	68.20	-28.05	Pk	Vertical
7223.01	34.46	43.50	11.40	35.50	3.40	37.86	54.00	-16.14	AV	Vertical
7220.11	37.92	43.50	11.40	35.50	3.40	41.32	68.20	-26.88	Pk	Horizontal
7220.11	33.81	43.50	11.40	35.50	3.40	37.21	54.00	-16.79	AV	Horizontal
10400.03	39.26	44.50	13.80	38.80	8.10	47.36	68.20	-20.84	Pk	Vertical
10400.03	37.06	44.50	13.80	38.80	8.10	45.16	54.00	-8.84	AV	Vertical
10400.07	40.02	44.50	13.80	38.80	8.10	48.12	68.20	-20.08	Pk	Horizontal
10400.07	36.27	44.50	13.80	38.80	8.10	44.37	54.00	-9.63	AV	Horizontal
11018.43	33.38	43.60	14.30	39.50	10.20	43.58	74.00	-30.42	Pk	Vertical
11018.43	30.44	43.60	14.30	39.50	10.20	40.64	54.00	-13.36	AV	Vertical
11035.01	34.11	43.60	14.30	39.50	10.20	44.31	74.00	-29.69	Pk	Horizontal
11035.01	30.37	43.60	14.30	39.50	10.20	40.57	54.00	-13.43	AV	Horizontal
13290.85	31.58	42.60	15.90	38.90	12.20	43.78	74.00	-30.22	Pk	Vertical
13290.85	29.03	42.60	15.90	38.90	12.20	41.23	54.00	-12.77	AV	Vertical
13291.36	32.44	42.60	15.90	38.90	12.20	44.64	74.00	-29.36	Pk	Horizontal
13291.36	29.10	42.60	15.90	38.90	12.20	41.30	54.00	-12.70	AV	Horizontal



High Channel (802.11n20/ 5700 MHz)										
3248.24	44.60	44.70	6.70	28.20	-9.80	34.80	68.20	-33.40	Pk	Vertical
3248.24	41.49	44.70	6.70	28.20	-9.80	31.69	54.00	-22.31	AV	Vertical
3250.52	44.02	44.70	6.70	28.20	-9.80	34.22	68.20	-33.98	Pk	Horizontal
3250.52	41.05	44.70	6.70	28.20	-9.80	31.25	54.00	-22.75	AV	Horizontal
3987.18	39.96	44.20	7.90	29.70	-6.60	33.36	74.00	-40.64	Pk	Vertical
3987.18	36.26	44.20	7.90	29.70	-6.60	29.66	54.00	-24.34	AV	Vertical
3980.35	39.03	44.20	7.90	29.70	-6.60	32.43	74.00	-41.57	Pk	Horizontal
3980.35	36.90	44.20	7.90	29.70	-6.60	30.30	54.00	-23.70	AV	Horizontal
7218.34	37.87	43.50	11.40	35.50	3.40	41.27	68.20	-26.93	Pk	Vertical
7218.34	34.71	43.50	11.40	35.50	3.40	38.11	54.00	-15.89	AV	Vertical
7235.78	37.66	43.50	11.40	35.50	3.40	41.06	68.20	-27.14	Pk	Horizontal
7235.78	33.88	43.50	11.40	35.50	3.40	37.28	54.00	-16.72	AV	Horizontal
10480.33	40.14	44.50	13.80	38.80	8.10	48.24	68.20	-19.96	Pk	Vertical
10480.33	36.07	44.50	13.80	38.80	8.10	44.17	54.00	-9.83	AV	Vertical
10479.96	39.08	44.50	13.80	38.80	8.10	47.18	68.20	-21.02	Pk	Horizontal
10479.96	36.70	44.50	13.80	38.80	8.10	44.80	54.00	-9.20	AV	Horizontal
11029.91	33.81	43.60	14.30	39.50	10.20	44.01	74.00	-29.99	Pk	Vertical
11029.91	29.80	43.60	14.30	39.50	10.20	40.00	54.00	-14.00	AV	Vertical
11035.77	33.68	43.60	14.30	39.50	10.20	43.88	74.00	-30.12	Pk	Horizontal
11035.77	30.69	43.60	14.30	39.50	10.20	40.89	54.00	-13.11	AV	Horizontal
13285.65	32.08	42.60	15.90	38.90	12.20	44.28	74.00	-29.72	Pk	Vertical
13285.65	29.49	42.60	15.90	38.90	12.20	41.69	54.00	-12.31	AV	Vertical
13291.37	32.24	42.60	15.90	38.90	12.20	44.44	74.00	-29.56	Pk	Horizontal
13291.37	29.42	42.60	15.90	38.90	12.20	41.62	54.00	-12.38	AV	Horizontal

## Remark:

1. Factor = Antenna Factor + Cable Loss – Pre-amplifier.
2. Scan with 802.11n (HT-20) all have been tested the antenna 1, antenna 2 and antenna 1+2, the worst case is 802.11n(HT20) of the antenna 1+2.
3. The frequency emission of peak points that did not show above the forms are at least 20dB below the limit, the frequency emission is mainly from the environment noise.





## U-NII-3 (5.725-5.850) GHz

Frequency (MHz)	Reading (dBuV)	Amplifier (dB)	Loss (dB)	Antenna Factor (dB/m)	Orrected Factor (dB)	Emission Level (dBuV/m)	Limit (dBuV/m)	Margin (dB)	Detector	Comment
Low Channel (802.11n20/ 5745 MHz)										
3263.27	44.29	44.70	6.70	28.20	-9.80	34.49	74.00	-39.51	Pk	Vertical
3263.27	42.11	44.70	6.70	28.20	-9.80	32.31	54.00	-21.69	AV	Vertical
3256.00	45.25	44.70	6.70	28.20	-9.80	35.45	68.20	-32.75	Pk	Horizontal
3256.00	41.13	44.70	6.70	28.20	-9.80	31.33	54.00	-22.67	AV	Horizontal
3990.99	38.94	44.20	7.90	29.70	-6.60	32.34	74.00	-41.66	Pk	Vertical
3990.99	36.77	44.20	7.90	29.70	-6.60	30.17	54.00	-23.83	AV	Vertical
3983.34	39.83	44.20	7.90	29.70	-6.60	33.23	74.00	-40.77	Pk	Horizontal
3983.34	35.93	44.20	7.90	29.70	-6.60	29.33	54.00	-24.67	AV	Horizontal
7228.65	37.29	43.50	11.40	35.50	3.40	40.69	68.20	-27.51	Pk	Vertical
7228.65	34.73	43.50	11.40	35.50	3.40	38.13	54.00	-15.87	AV	Vertical
7233.20	36.50	43.50	11.40	35.50	3.40	39.90	68.20	-28.30	Pk	Horizontal
7233.20	34.87	43.50	11.40	35.50	3.40	38.27	54.00	-15.73	AV	Horizontal
10360.43	39.47	44.50	13.80	38.80	8.10	47.57	68.20	-20.63	Pk	Vertical
10360.43	37.01	44.50	13.80	38.80	8.10	45.11	54.00	-8.89	AV	Vertical
10360.22	39.12	44.50	13.80	38.80	8.10	47.22	68.20	-20.98	Pk	Horizontal
10360.22	36.18	44.50	13.80	38.80	8.10	44.28	54.00	-9.72	AV	Horizontal
11025.80	33.05	43.60	14.30	39.50	10.20	43.25	74.00	-30.75	Pk	Vertical
11025.80	31.16	43.60	14.30	39.50	10.20	41.36	54.00	-12.64	AV	Vertical
11028.06	34.07	43.60	14.30	39.50	10.20	44.27	74.00	-29.73	Pk	Horizontal
11028.06	31.03	43.60	14.30	39.50	10.20	41.23	54.00	-12.77	AV	Horizontal
13291.72	32.49	42.60	15.90	38.90	12.20	44.69	74.00	-29.31	Pk	Vertical
13291.72	29.83	42.60	15.90	38.90	12.20	42.03	54.00	-11.97	AV	Vertical
13295.95	31.55	42.60	15.90	38.90	12.20	43.75	74.00	-30.25	Pk	Horizontal
13295.95	29.86	42.60	15.90	38.90	12.20	42.06	54.00	-11.94	AV	Horizontal
Mid Channel (802.11n20/ 5785MHz)										
3250.19	44.93	44.70	6.70	28.20	-9.80	35.13	68.20	-33.07	Pk	Vertical
3250.19	42.13	44.70	6.70	28.20	-9.80	32.33	54.00	-21.67	AV	Vertical
3255.11	44.41	44.70	6.70	28.20	-9.80	34.61	68.20	-33.59	Pk	Horizontal
3255.11	40.89	44.70	6.70	28.20	-9.80	31.09	54.00	-22.91	AV	Horizontal
3986.13	39.23	44.20	7.90	29.70	-6.60	32.63	74.00	-41.37	Pk	Vertical
3986.13	36.59	44.20	7.90	29.70	-6.60	29.99	54.00	-24.01	AV	Vertical
3992.62	38.88	44.20	7.90	29.70	-6.60	32.28	74.00	-41.72	Pk	Horizontal
3992.62	35.98	44.20	7.90	29.70	-6.60	29.38	54.00	-24.62	AV	Horizontal
7222.93	37.61	43.50	11.40	35.50	3.40	41.01	68.20	-27.19	Pk	Vertical
7222.93	33.87	43.50	11.40	35.50	3.40	37.27	54.00	-16.73	AV	Vertical
7216.68	36.74	43.50	11.40	35.50	3.40	40.14	68.20	-28.06	Pk	Horizontal
7216.68	34.74	43.50	11.40	35.50	3.40	38.14	54.00	-15.86	AV	Horizontal
10400.03	39.51	44.50	13.80	38.80	8.10	47.61	68.20	-20.59	Pk	Vertical
10400.03	35.71	44.50	13.80	38.80	8.10	43.81	54.00	-10.19	AV	Vertical
10400.25	39.95	44.50	13.80	38.80	8.10	48.05	68.20	-20.15	Pk	Horizontal
10400.25	35.99	44.50	13.80	38.80	8.10	44.09	54.00	-9.91	AV	Horizontal
11016.73	33.07	43.60	14.30	39.50	10.20	43.27	74.00	-30.73	Pk	Vertical
11016.73	29.79	43.60	14.30	39.50	10.20	39.99	54.00	-14.01	AV	Vertical
11025.25	33.60	43.60	14.30	39.50	10.20	43.80	74.00	-30.20	Pk	Horizontal
11025.25	30.23	43.60	14.30	39.50	10.20	40.43	54.00	-13.57	AV	Horizontal
13282.03	32.89	42.60	15.90	38.90	12.20	45.09	74.00	-28.91	Pk	Vertical
13282.03	29.56	42.60	15.90	38.90	12.20	41.76	54.00	-12.24	AV	Vertical
13294.69	32.14	42.60	15.90	38.90	12.20	44.34	74.00	-29.66	Pk	Horizontal
13294.69	29.29	42.60	15.90	38.90	12.20	41.49	54.00	-12.51	AV	Horizontal



High Channel (802.11n20/ 5825 MHz)										
3253.99	45.17	44.70	6.70	28.20	-9.80	35.37	68.20	-32.83	Pk	Vertical
3253.99	41.04	44.70	6.70	28.20	-9.80	31.24	54.00	-22.76	AV	Vertical
3264.16	44.82	44.70	6.70	28.20	-9.80	35.02	74.00	-38.98	Pk	Horizontal
3264.16	41.17	44.70	6.70	28.20	-9.80	31.37	54.00	-22.63	AV	Horizontal
3999.27	38.89	44.20	7.90	29.70	-6.60	32.29	74.00	-41.71	Pk	Vertical
3999.27	36.48	44.20	7.90	29.70	-6.60	29.88	54.00	-24.12	AV	Vertical
3990.09	40.10	44.20	7.90	29.70	-6.60	33.50	74.00	-40.50	Pk	Horizontal
3990.09	36.44	44.20	7.90	29.70	-6.60	29.84	54.00	-24.16	AV	Horizontal
7220.18	36.57	43.50	11.40	35.50	3.40	39.97	68.20	-28.23	Pk	Vertical
7220.18	33.90	43.50	11.40	35.50	3.40	37.30	54.00	-16.70	AV	Vertical
7235.47	36.69	43.50	11.40	35.50	3.40	40.09	68.20	-28.11	Pk	Horizontal
7235.47	34.90	43.50	11.40	35.50	3.40	38.30	54.00	-15.70	AV	Horizontal
10480.08	39.81	44.50	13.80	38.80	8.10	47.91	68.20	-20.29	Pk	Vertical
10480.08	37.08	44.50	13.80	38.80	8.10	45.18	54.00	-8.82	AV	Vertical
10480.30	40.16	44.50	13.80	38.80	8.10	48.26	68.20	-19.94	Pk	Horizontal
10480.30	36.73	44.50	13.80	38.80	8.10	44.83	54.00	-9.17	AV	Horizontal
11019.15	33.70	43.60	14.30	39.50	10.20	43.90	74.00	-30.10	Pk	Vertical
11019.15	29.75	43.60	14.30	39.50	10.20	39.95	54.00	-14.05	AV	Vertical
11027.57	33.73	43.60	14.30	39.50	10.20	43.93	74.00	-30.07	Pk	Horizontal
11027.57	29.93	43.60	14.30	39.50	10.20	40.13	54.00	-13.87	AV	Horizontal
13292.82	32.70	42.60	15.90	38.90	12.20	44.90	74.00	-29.10	Pk	Vertical
13292.82	28.81	42.60	15.90	38.90	12.20	41.01	54.00	-12.99	AV	Vertical
13288.00	32.14	42.60	15.90	38.90	12.20	44.34	74.00	-29.66	Pk	Horizontal
13288.00	28.59	42.60	15.90	38.90	12.20	40.79	54.00	-13.21	AV	Horizontal

**Remark:**

1. Factor = Antenna Factor + Cable Loss – Pre-amplifier.
2. Scan with 802.11n (HT-20) all have been tested the antenna 1, antenna 2 and antenna 1+2, the worst case is 802.11n(HT20) of the antenna 1+2.
3. The frequency emission of peak points that did not show above the forms are at least 20dB below the limit, the frequency emission is mainly from the environment noise.

### 3.2.9 RESTRICTED FREQUENCY BANDS AND BAND EDGE

#### U-NII-1 5150-5250MHz

802.11n20-L-H

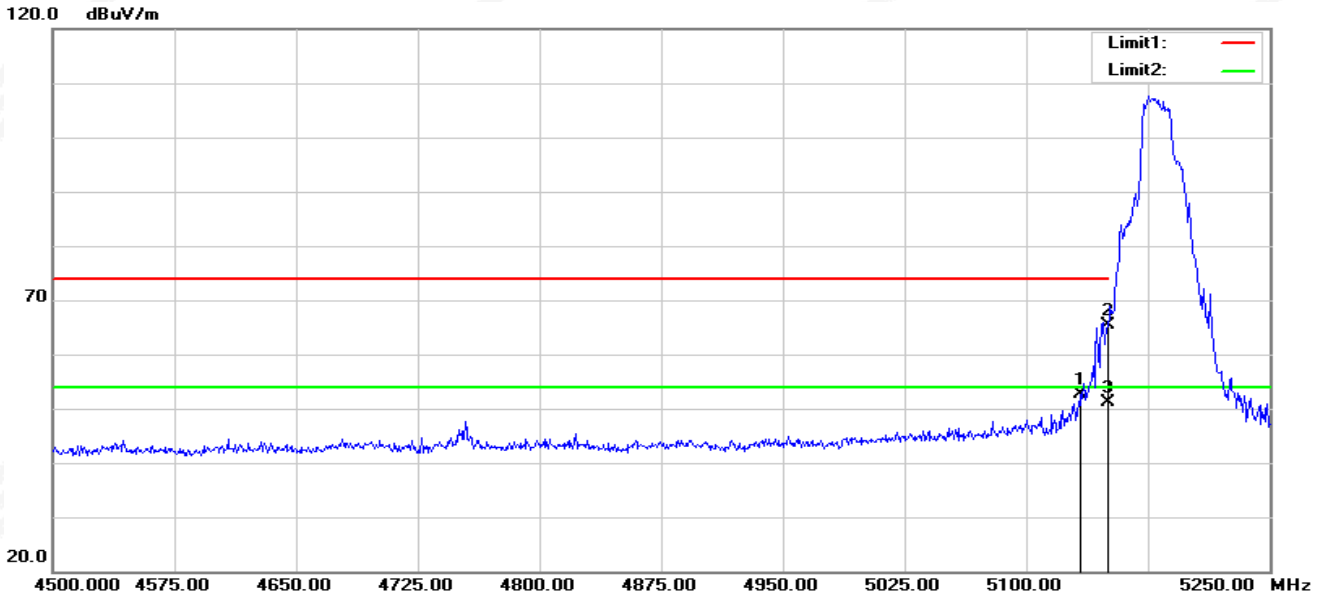

No.	Frequency (MHz)	Reading (dBuV)	Correct Factor(dB/m)	Result (dBuV/m)	Limit (dBuV/m)	Margin (dB)	Remark
1	5133.750	58.35	-5.73	52.62	74.00	-21.38	peak
2	5150.000	71.09	-5.73	65.36	74.00	-8.64	peak
3	5150.000	56.81	-5.73	51.08	54.00	-2.92	AVG

802.11n20-L-V

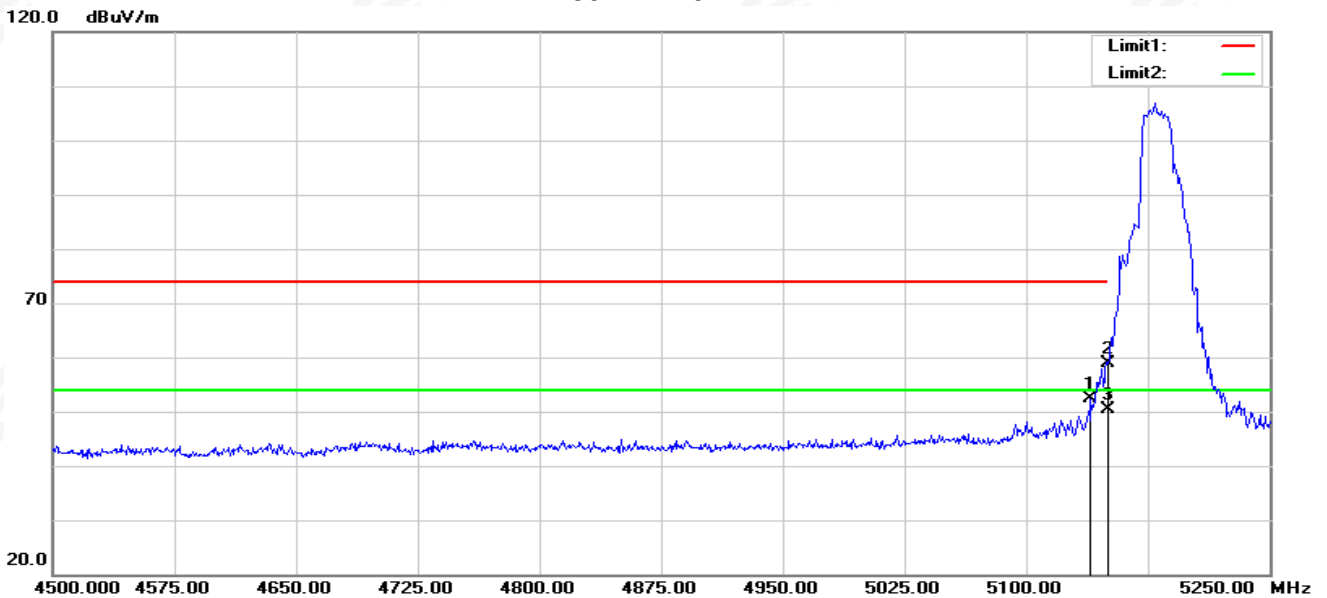

No.	Frequency (MHz)	Reading (dBuV)	Correct Factor(dB/m)	Result (dBuV/m)	Limit (dBuV/m)	Margin (dB)	Remark
1	5139.750	58.06	-5.74	52.32	74.00	-21.68	peak
2	5150.000	64.70	-5.73	58.97	74.00	-15.03	peak
3	5150.000	56.04	-5.73	50.31	54.00	-3.69	AVG



802.11n20-H-H

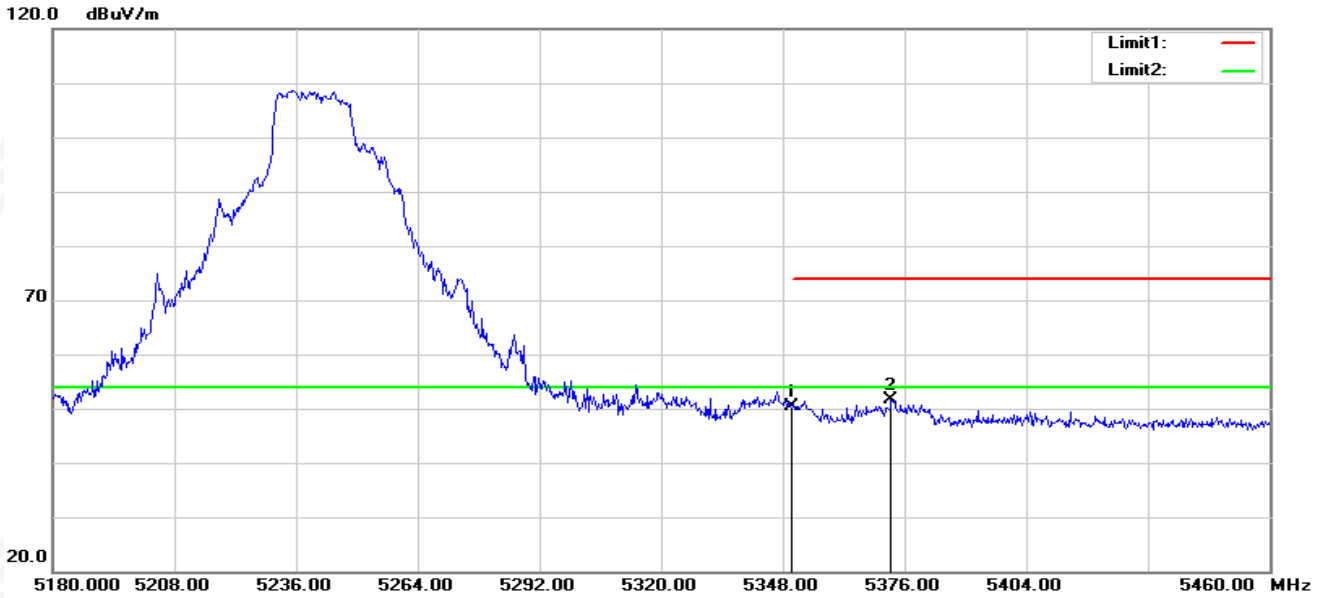

No.	Frequency (MHz)	Reading (dBuV)	Correct Factor(dB/m)	Result (dBuV/m)	Limit (dBuV/m)	Margin (dB)	Remark
1	5350.000	55.73	-5.23	50.50	74.00	-23.50	peak
2	5372.920	56.99	-5.24	51.75	74.00	-22.25	peak

802.11n20-H-V

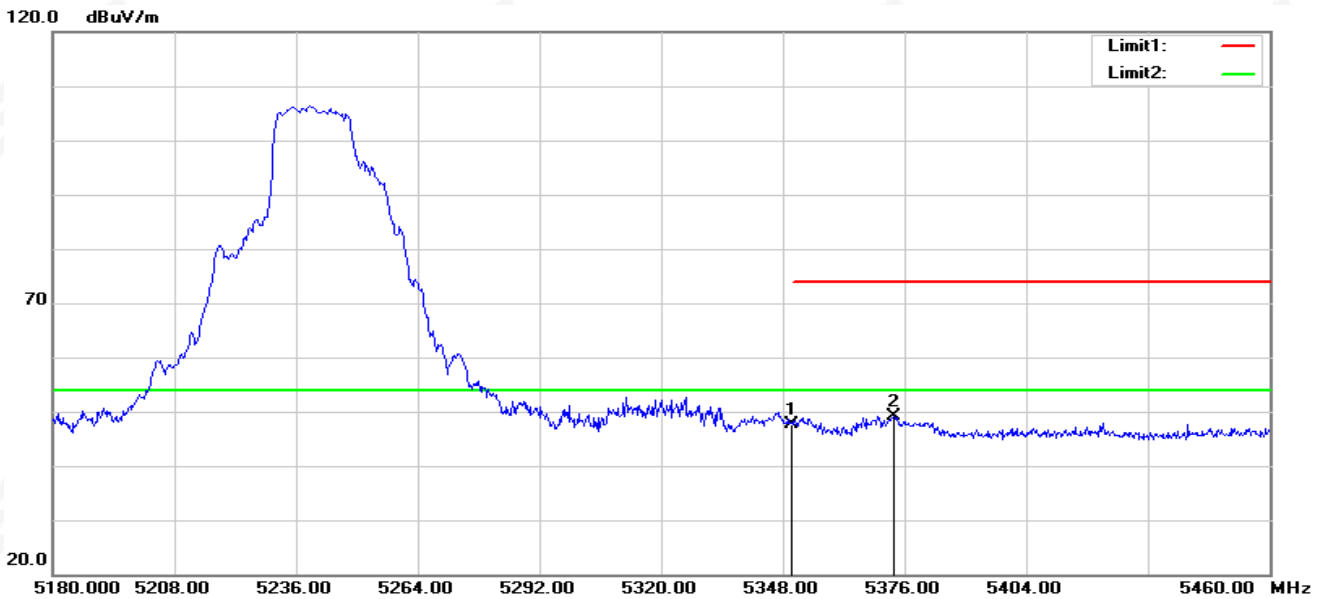

No.	Frequency (MHz)	Reading (dBuV)	Correct Factor(dB/m)	Result (dBuV/m)	Limit (dBuV/m)	Margin (dB)	Remark
1	5350.000	52.93	-5.23	47.70	74.00	-26.30	peak
2	5373.480	54.34	-5.24	49.10	74.00	-24.90	peak

Note: All modes have been tested. Only the worst mode shown in the report.

U-NII-2A 5250-5350MHz

802.11n20-L-H

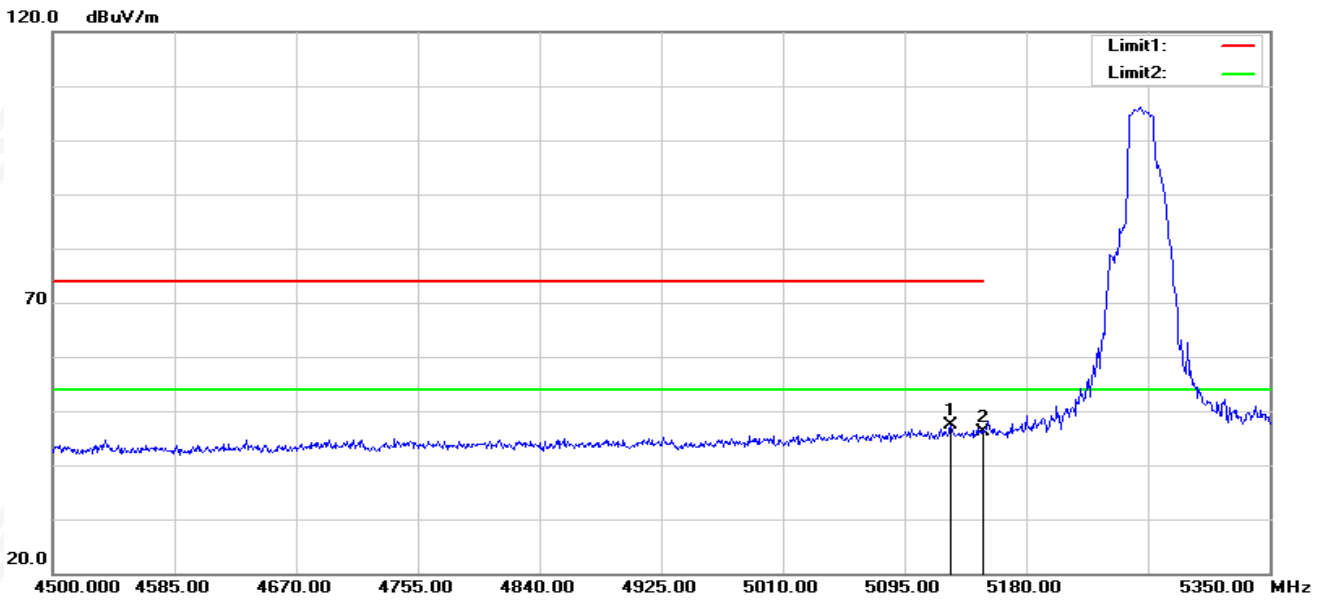

No.	Frequency (MHz)	Reading (dBuV)	Correct Factor(dB/m)	Result (dBuV/m)	Limit (dBuV/m)	Margin (dB)	Remark
1	5127.300	53.06	-5.74	47.32	74.00	-26.68	peak
2	5150.000	51.79	-5.73	46.06	74.00	-27.94	peak

802.11n20-L-V

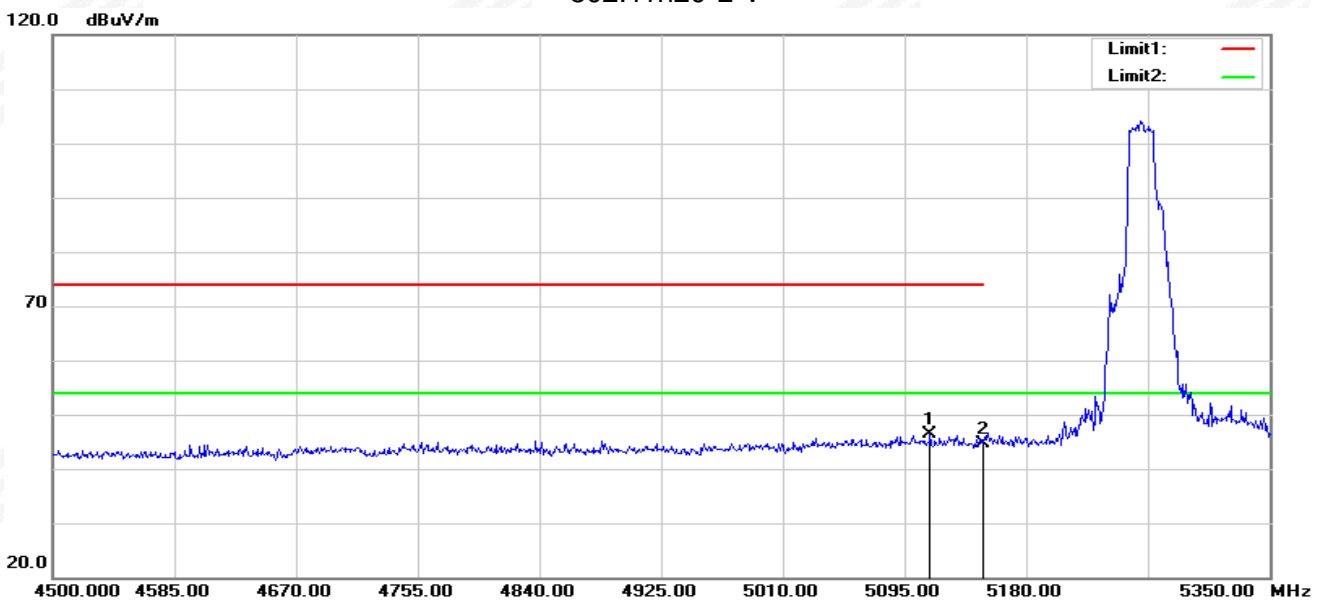

No.	Frequency (MHz)	Reading (dBuV)	Correct Factor(dB/m)	Result (dBuV/m)	Limit (dBuV/m)	Margin (dB)	Remark
1	5112.850	52.00	-5.74	46.26	74.00	-27.74	peak
2	5150.000	50.45	-5.73	44.72	74.00	-29.28	peak

802.11n20-H-H

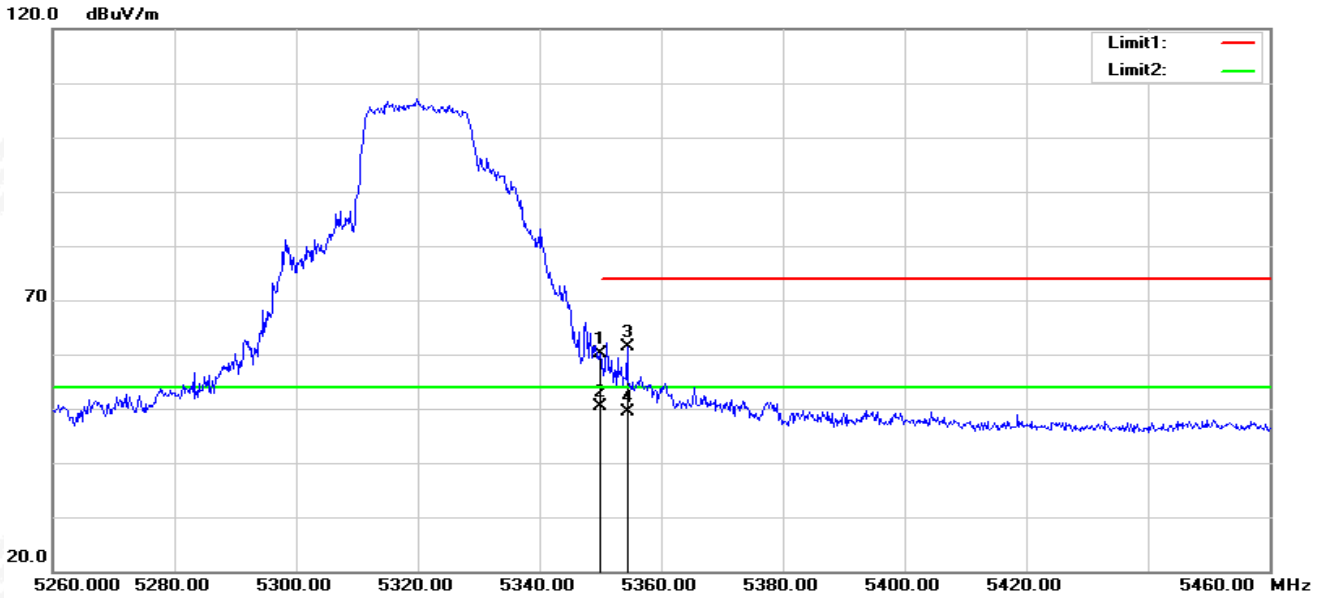

No.	Frequency (MHz)	Reading (dBuV)	Correct Factor(dB/m)	Result (dBuV/m)	Limit (dBuV/m)	Margin (dB)	Remark
1	5350.000	65.47	-5.23	60.24	74.00	-13.76	peak
2	5350.000	55.62	-5.23	50.39	54.00	-3.61	AVG
3	5354.400	66.56	-5.24	61.32	74.00	-12.68	peak
4	5354.400	54.61	-5.24	49.37	54.00	-4.63	AVG

802.11n20-H-V

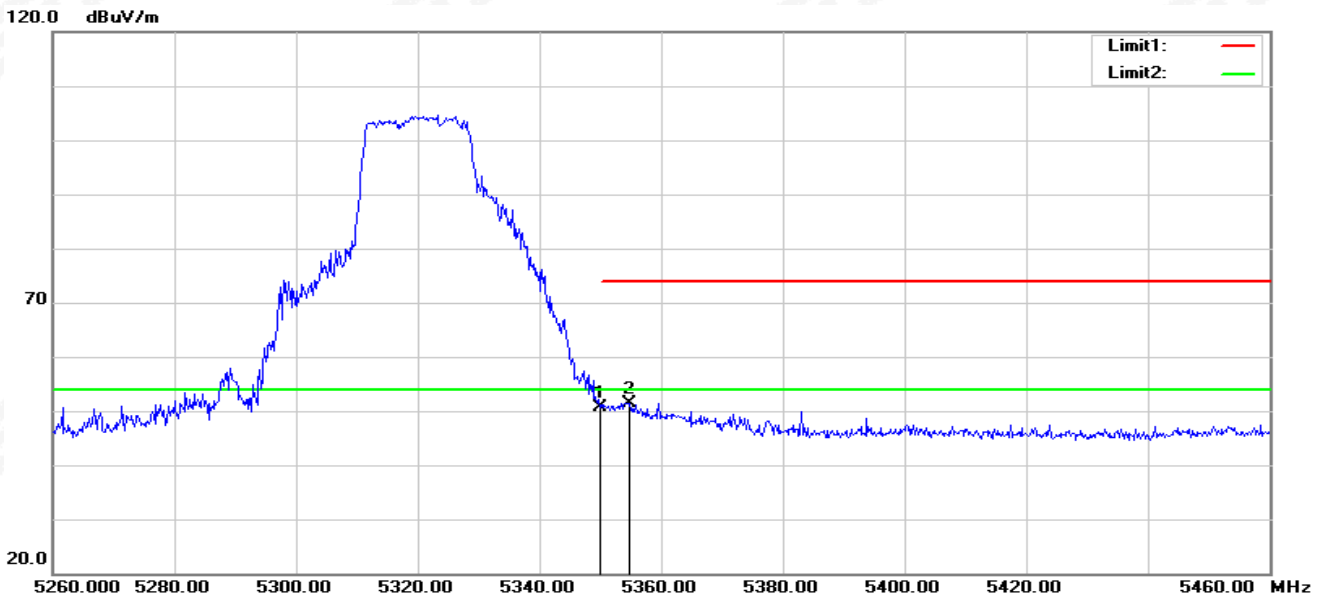

No.	Frequency (MHz)	Reading (dBuV)	Correct Factor(dB/m)	Result (dBuV/m)	Limit (dBuV/m)	Margin (dB)	Remark
1	5350.000	55.79	-5.23	50.56	74.00	-23.44	peak
2	5354.800	56.64	-5.24	51.40	74.00	-22.60	peak

Note: All modes have been tested. Only the worst mode shown in the report.

U-NII-2C 5470-5725MHz

802.11n20-L-H

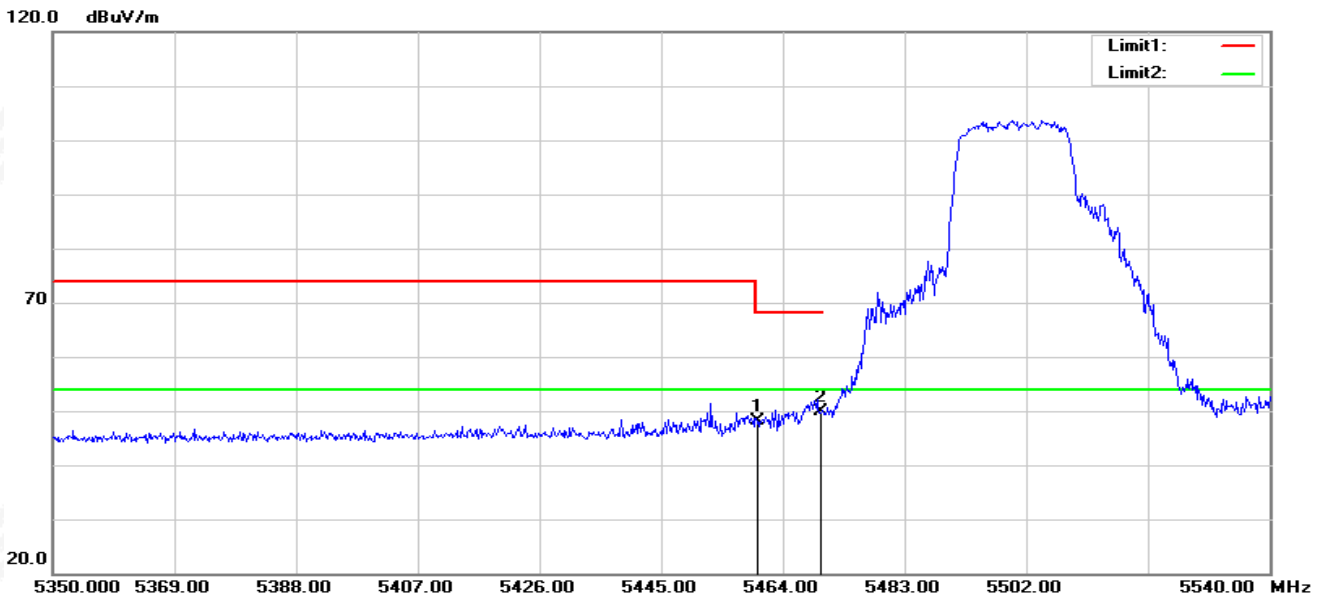

No.	Frequency (MHz)	Reading (dBuV)	Correct Factor(dB/m)	Result (dBuV/m)	Limit (dBuV/m)	Margin (dB)	Remark
1	5460.000	53.21	-5.11	48.10	68.20	-20.10	peak
2	5470.000	54.88	-5.09	49.79	68.20	-18.41	peak

802.11n20-L-V

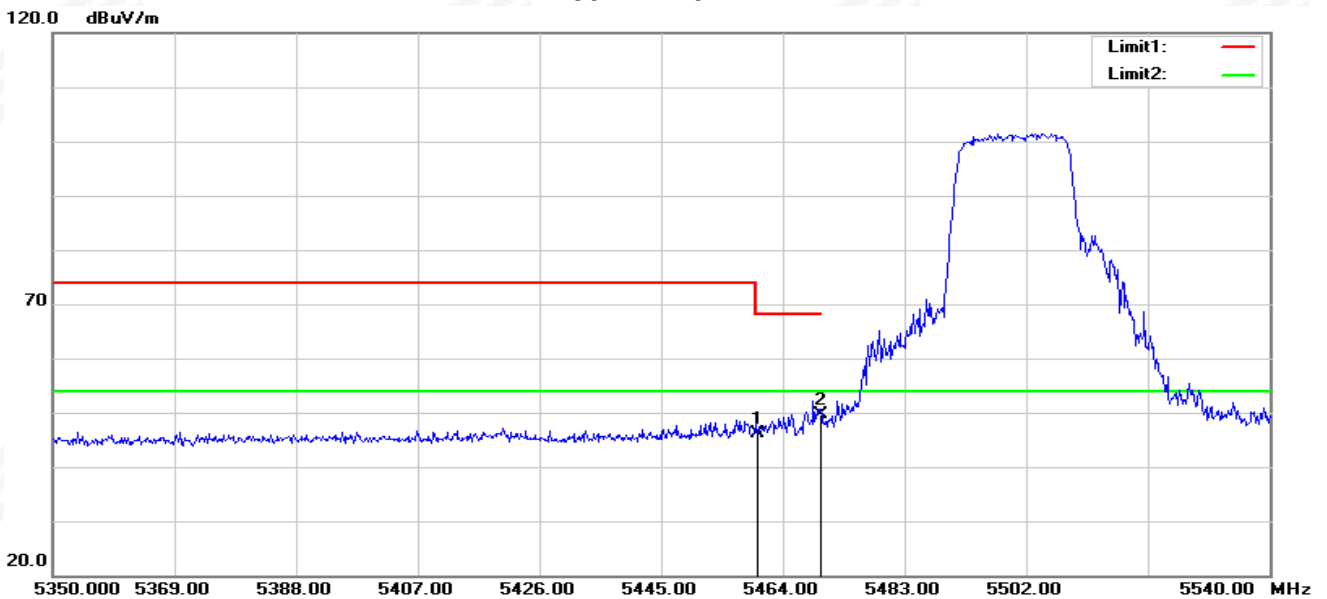

No.	Frequency (MHz)	Reading (dBuV)	Correct Factor(dB/m)	Result (dBuV/m)	Limit (dBuV/m)	Margin (dB)	Remark
1	5460.000	51.28	-5.11	46.17	68.20	-22.03	peak
2	5470.000	54.82	-5.09	49.73	68.20	-18.47	peak

802.11n20-H-H

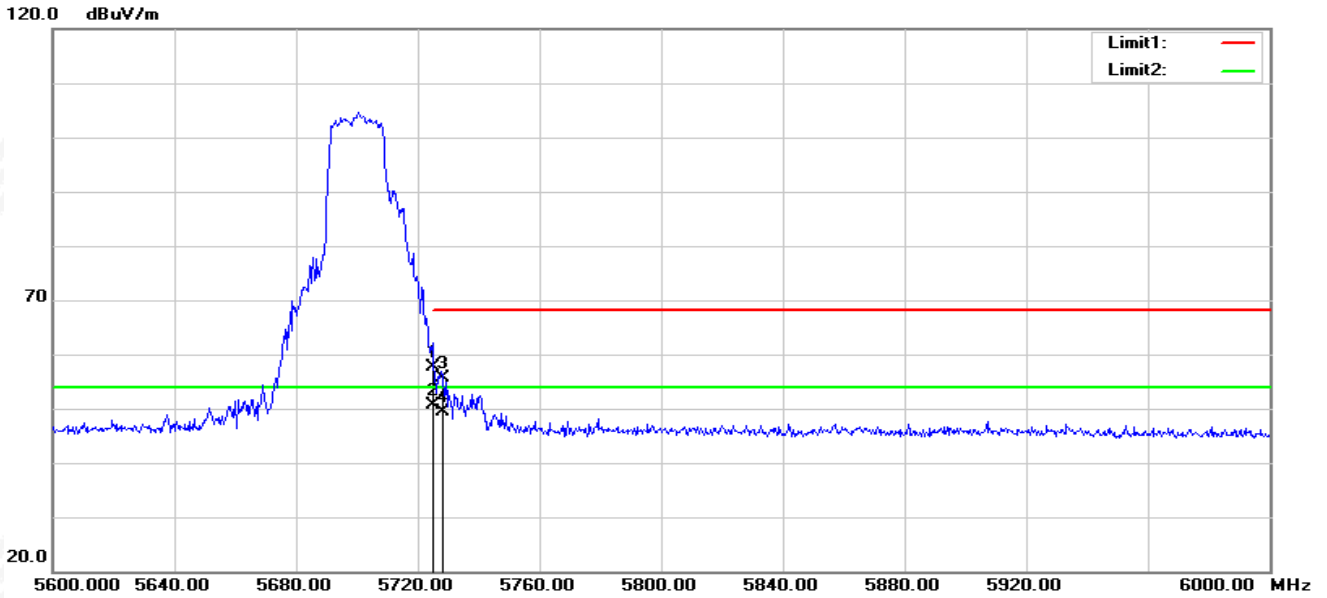

No.	Frequency (MHz)	Reading (dBuV)	Correct Factor(dB/m)	Result (dBuV/m)	Limit (dBuV/m)	Margin (dB)	Remark
1	5725.000	62.23	-4.57	57.66	68.20	-10.54	peak
2	5725.000	55.26	-4.57	50.69	54.00	-3.31	AVG
3	5728.400	60.25	-4.56	55.69	68.20	-12.51	peak
4	5728.400	53.86	-4.56	49.30	54.00	-4.70	AVG

802.11n20-H-V

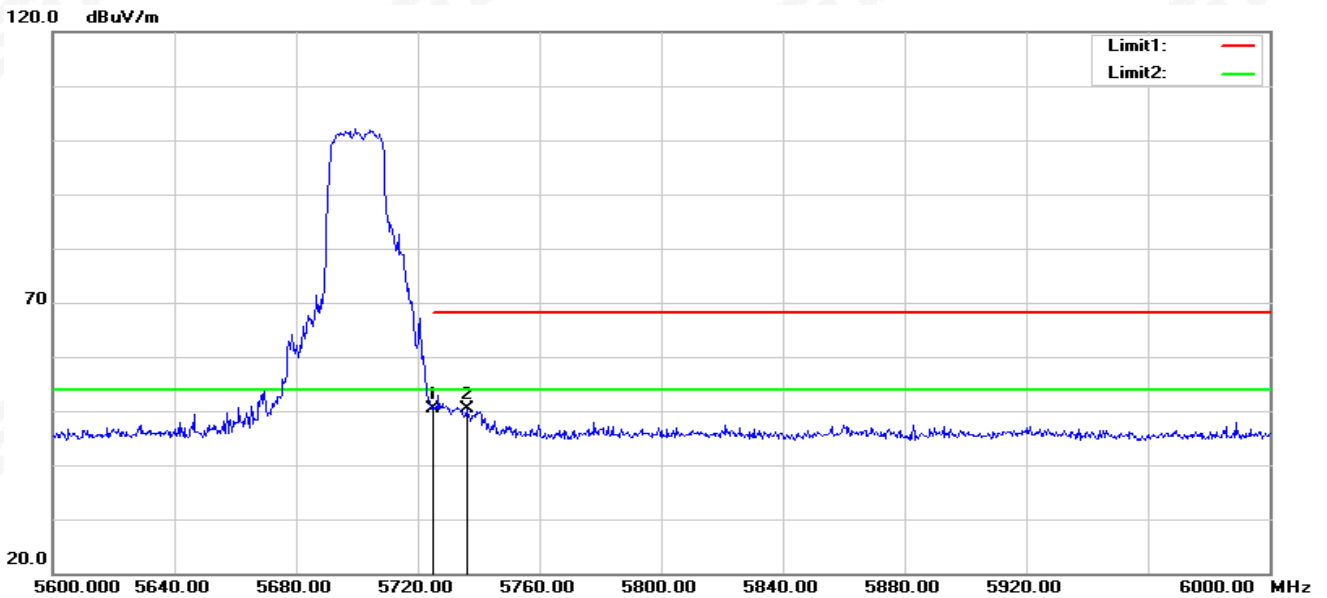

No.	Frequency (MHz)	Reading (dBuV)	Correct Factor(dB/m)	Result (dBuV/m)	Limit (dBuV/m)	Margin (dB)	Remark
1	5725.000	55.07	-4.57	50.50	68.20	-17.70	peak
2	5736.000	54.99	-4.54	50.45	68.20	-17.75	peak

Note: All modes have been tested. Only the worst mode shown in the report.



U-NII-3 (5.725-5.85 GHz)

802.11n20-L-H

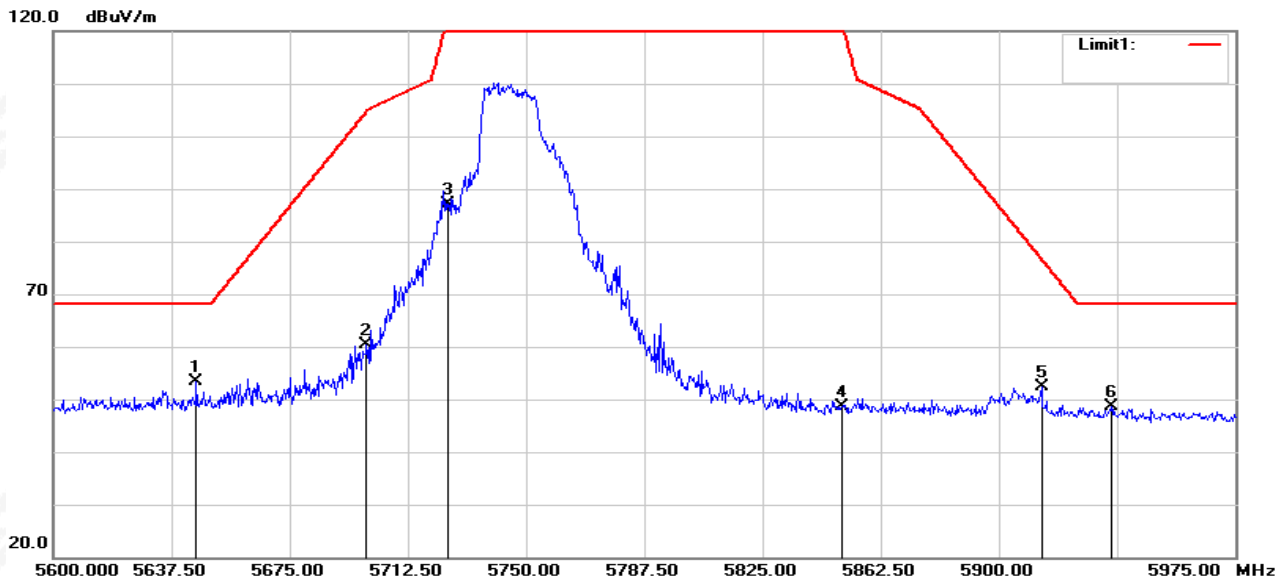

No.	Frequency (MHz)	Reading (dBuV)	Correct Factor(dB/m)	Result (dBuV/m)	Limit (dBuV/m)	Margin (dB)	Remark
1	5645.375	58.02	-4.68	53.34	68.20	-14.86	peak
2	5699.375	65.03	-4.66	60.37	104.74	-44.37	peak
3	5725.000	91.64	-4.57	87.07	122.20	-35.13	peak
4	5850.000	52.84	-4.10	48.74	122.20	-73.46	peak
5	5913.500	56.28	-3.90	52.38	76.71	-24.33	peak
6	5935.625	52.59	-3.94	48.65	68.20	-19.55	peak

802.11n20-L-V

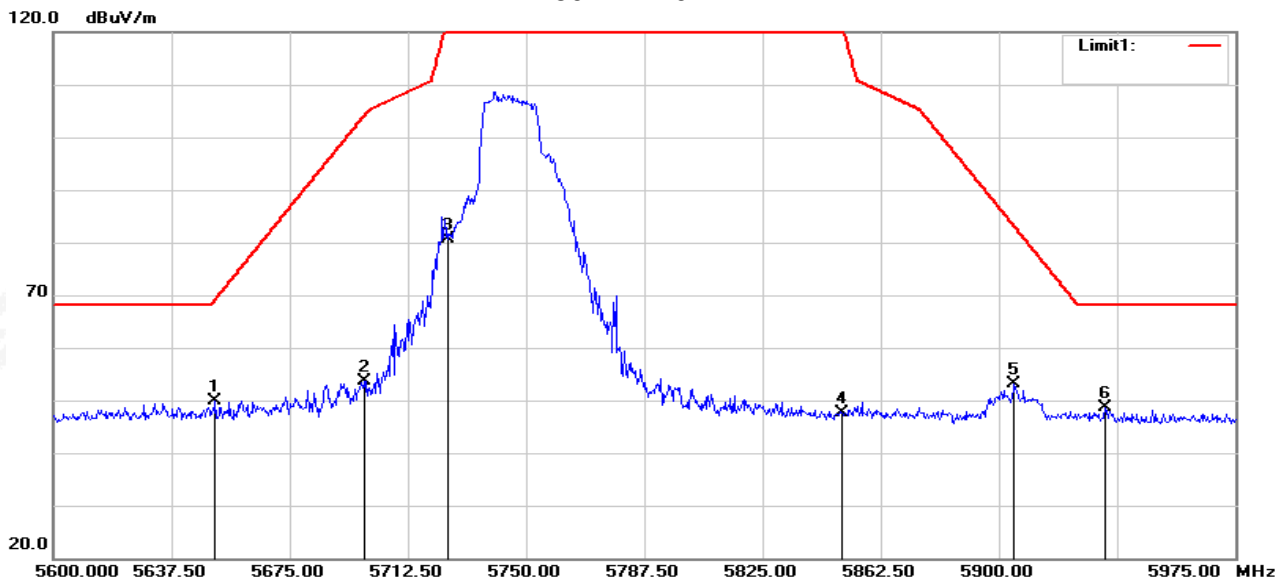

No.	Frequency (MHz)	Reading (dBuV)	Correct Factor(dB/m)	Result (dBuV/m)	Limit (dBuV/m)	Margin (dB)	Remark
1	5651.375	54.52	-4.68	49.84	69.22	-19.38	peak
2	5698.625	58.34	-4.66	53.68	104.18	-50.50	peak
3	5725.000	85.19	-4.57	80.62	122.20	-41.58	peak
4	5850.000	51.64	-4.10	47.54	122.20	-74.66	peak
5	5904.875	57.08	-3.89	53.19	83.09	-29.90	peak
6	5933.750	52.49	-3.94	48.55	68.20	-19.65	peak

802.11n20-H-H

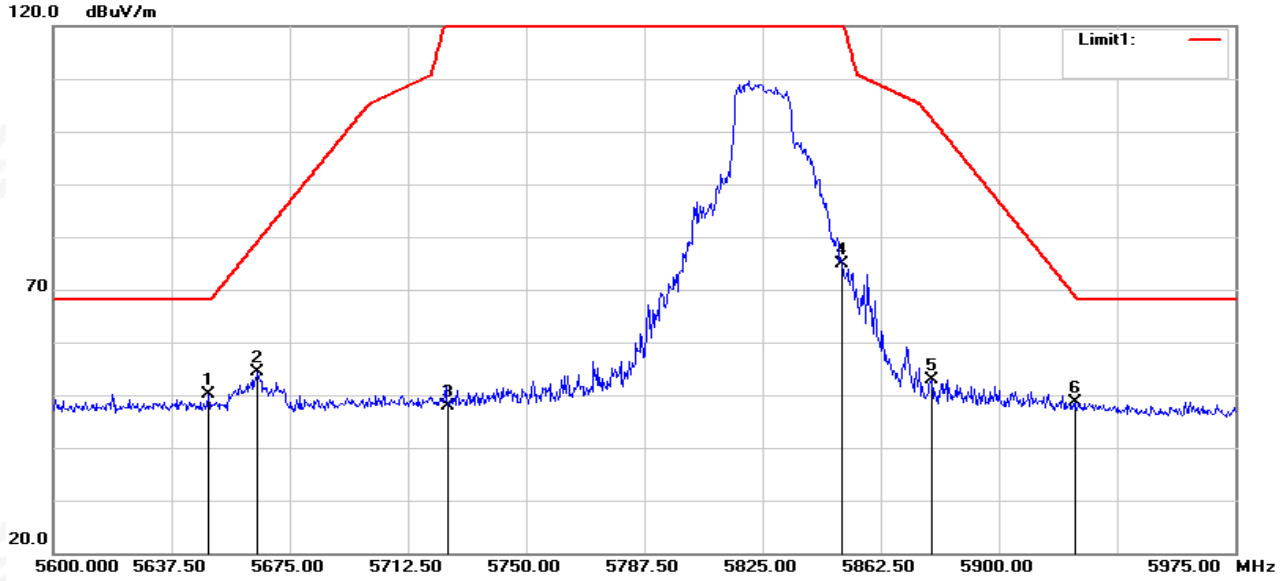

No.	Frequency (MHz)	Reading (dBuV)	Correct Factor(dB/m)	Result (dBuV/m)	Limit (dBuV/m)	Margin (dB)	Remark
1	5649.125	54.83	-4.68	50.15	68.20	-18.05	peak
2	5664.875	58.97	-4.68	54.29	79.21	-24.92	peak
3	5725.000	52.51	-4.57	47.94	122.20	-74.26	peak
4	5850.000	79.01	-4.10	74.91	122.20	-47.29	peak
5	5878.625	56.84	-3.97	52.87	102.52	-49.65	peak
6	5924.375	52.63	-3.92	48.71	68.66	-19.95	peak

802.11n20-H-V

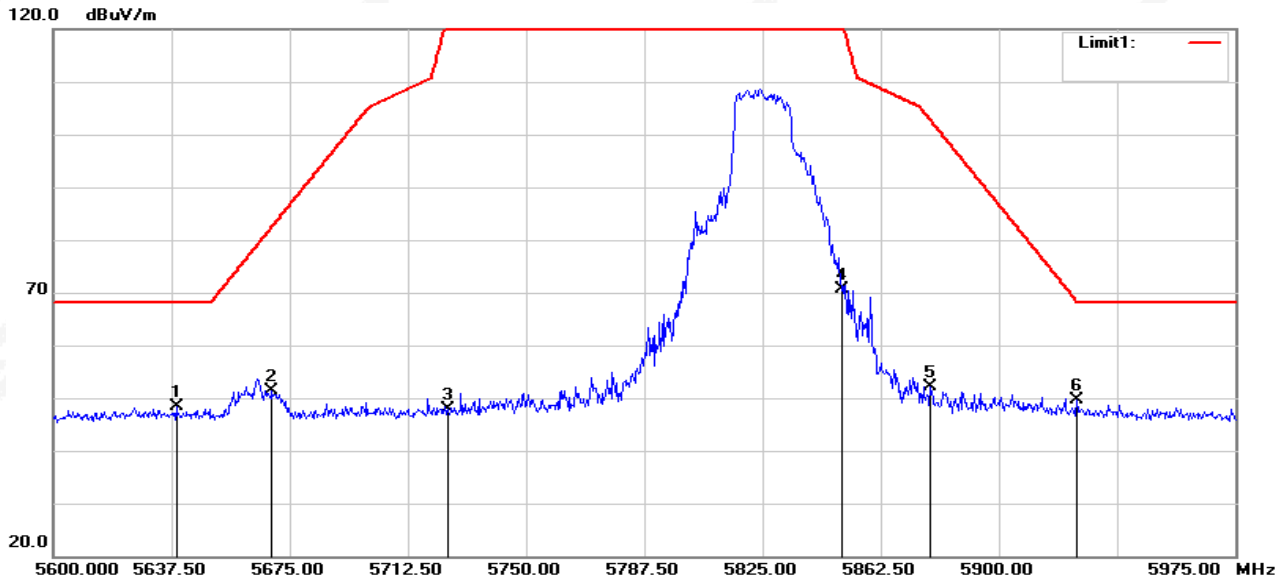

No.	Frequency (MHz)	Reading (dBuV)	Correct Factor(dB/m)	Result (dBuV/m)	Limit (dBuV/m)	Margin (dB)	Remark
1	5639.000	53.17	-4.69	48.48	68.20	-19.72	peak
2	5669.375	55.99	-4.67	51.32	82.54	-31.22	peak
3	5725.000	52.39	-4.57	47.82	122.20	-74.38	peak
4	5850.000	74.84	-4.10	70.74	122.20	-51.46	peak
5	5878.250	56.15	-3.97	52.18	102.80	-50.62	peak
6	5924.750	53.66	-3.92	49.74	68.39	-18.65	peak

Note: All modes have been tested. Only the worst mode shown in the report.

## 4. POWER SPECTRAL DENSITY TEST

### 4.1 LIMIT

1. For mobile and portable client devices in the 5.15-5.25 GHz band, , the maximum power spectral density shall not exceed 11 dBm in any 1 megahertz band. If transmitting antennas of directional gain greater than 6 dBi are used, both the maximum conducted output power and the maximum power spectral density shall be reduced by the amount in dB that the directional gain of the antenna exceeds 6 dBi.
2. For the 5.25-5.35 GHz and 5.47-5.725 GHz bands, the maximum power spectral density shall not exceed 11 dBm in any 1 megahertz band. If transmitting antennas of directional gain greater than 6 dBi are used, both the maximum conducted output power and the maximum power spectral density shall be reduced by the amount in dB that the directional gain of the antenna exceeds 6 dBi.
3. For the band 5.725-5.850 GHz, the peak power spectral density shall not exceed 30 dBm in any 500KHz band. If transmitting antenna directional gain is greater than 6 dBi, both the maximum conducted output power and the peak power spectral density shall be reduced by the amount in dB that the directional gain of the antenna exceeds 6 dBi.

### 4.2 TEST PROCEDURE

1. The setting follows Method SA-1 of FCC KDB 789033 D02 General U-NII Test Procedures New Rules v02r01.

For devices operating in the band, the rules specify a measurement bandwidth of 500 kHz. Many spectrum analyzers do not have 500 kHz RBW, thus a narrower RBW may need to be used. The rules permit the use of a RBWs less than 1 MHz, or 500 kHz, "provided that the measured power is integrated over the full reference bandwidth" to show the total power over the specified measurement bandwidth (*i.e.*, 1 MHz, or 500 kHz). If measurements are performed using a reduced resolution bandwidth (< 1 MHz, or < 500 kHz) and integrated over 1 MHz, or 500 KHz bandwidth, the following adjustments to the procedures apply:

- a) Set  $RBW \geq 1/T$ , where  $T$  is defined in section II.B.I.a).
- b) Set  $VBW \geq 3 RBW$ .
- c) If measurement bandwidth of Maximum PSD is specified in 500 kHz, add  $10 \log (500\text{kHz}/RBW)$  to the measured result, whereas  $RBW (< 500 \text{ kHz})$  is the reduced resolution bandwidth of the spectrum analyzer set during measurement.
- d) If measurement bandwidth of Maximum PSD is specified in 1 MHz, add  $10 \log (1\text{MHz}/RBW)$  to the measured result, whereas  $RBW (< 1 \text{ MHz})$  is the reduced resolution bandwidth of spectrum analyzer set during measurement.
- e) Care must be taken to ensure that the measurements are performed during a period of continuous transmission or are corrected upward for duty cycle.

Note: As a practical matter, it is recommended to use reduced RBW of 100 kHz for the sections 5.c) and 5.d) above, since  $RBW=100 \text{ KHZ}$  is available on nearly all spectrum analyzers.

#### 4.3 DEVIATION FROM STANDARD

No deviation.

#### 4.4 TEST SETUP



#### 4.5 EUT OPERATION CONDITIONS

The EUT tested system was configured as the statements of 2.1 Unless otherwise a special operating condition is specified in the follows during the testing.

#### 4.6 TEST RESULTS

Note: The test data please reference to attachment "STS2310103W04\_Appendix 5G WIFI".

## 5. BANDWIDTH MEASUREMENT

### 5.1 EMISSION BANDWIDTH (EBW) 26 BANDWID PROCEDURES / LIMIT

The following procedure shall be used for measuring 26 bandwidth.

#### 5.1.1 TEST PROCEDURE

1. The testing follows FCC KDB 789033 D02 General UNII Test Procedures New Rules v02r01.
2. Set RBW = approximately 1% of the emission bandwidth.
3. Set the VBW  $\geq$  RBW.
4. Detector = Peak.
5. Trace mode = max hold.
6. Measure the maximum width of the emission that is 26 dB down from the peak of the emission. Compare this with the RBW setting of the analyzer. Readjust RBW and repeat measurement as needed until the RBW/EBW ratio is approximately 1%.

#### 5.1.2 DEVIATION FROM STANDARD

No deviation.

#### 5.1.3 TEST SETUP



#### 5.1.4 EUT OPERATION CONDITIONS

The EUT tested system was configured as the statements of 2.4 Unless otherwise a special operating condition is specified in the follows during the testing.

#### 5.1.5 TEST RESULTS

Note: 1. ANT 1 Power > ANT 2 Power, Both ANT 1 and 2 have been test, Only show the worst data of ANT 1.

2. The test data please reference to attachment "STS2310103W04\_Appendix 5G WIFI".

## 5.2 OCCUPIED BANDWIDTH ( 99%) TEST APPLIED PROCEDURES / LIMIT

The following procedure shall be used for measuring (99 %) power bandwidth.

### 5.2.1 TEST PROCEDURE

1. The testing follows FCC KDB 789033 D02 General UNII Test Procedures v02r01. The following procedure shall be used for measuring (99 %) power bandwidth:
  1. Set center frequency to the nominal EUT channel center frequency.
  2. Set span = 1.5 times to 5.0 times the OBW.
  3. Set RBW = 1 % to 5 % of the OBW
  4. Set VBW  $\geq 3 \cdot$  RBW
  5. Video averaging is not permitted. Where practical, a sample detection and single sweep mode shall be used. Otherwise, peak detection and max hold mode (until the trace stabilizes) shall be used.
  6. Use the 99 % power bandwidth function of the instrument (if available).
  7. If the instrument does not have a 99 % power bandwidth function, the trace data points are recovered and directly summed in power units. The recovered amplitude data points, beginning at the lowest frequency, are placed in a running sum until 0.5 % of the total is reached; that frequency is recorded as the lower frequency. The process is repeated until 99.5 % of the total is reached; that frequency is recorded as the upper frequency. The 99% occupied bandwidth is the difference between these two frequencies.

### 5.2.2 DEVIATION FROM STANDARD

No deviation.

### 5.2.3 TEST SETUP



### 5.2.4 EUT OPERATION CONDITIONS

The EUT tested system was configured as the statements of 2.4 Unless otherwise a special operating condition is specified in the follows during the testing.

### 5.2.5 TEST RESULTS

- Note: 1. ANT 1 Power > ANT 2 Power, Both ANT1 and 2 have been test, Only show the worst data of ANT 1.
2. The test data please reference to attachment "STS2310103W04\_Appendix 5G WIFI".

### 5.3 MINIMUM EMISSION BANDWIDTH(6 DB) PROCEDURES / LIMIT

Section 15.407(e) specifies the minimum 6 dB emission bandwidth of at least 500 KHz for the band 5.725-5.85 GHz. The following procedure shall be used for measuring this bandwidth.

#### 5.3.1 TEST PROCEDURE

1. The testing follows FCC KDB 789033 D02 General UNII Test Procedures v02r01.
  - a) Set RBW = 100 kHz.
  - b) Set the video bandwidth (VBW)  $\geq 3 \times$  RBW.
  - c) Detector = Peak.
  - d) Trace mode = max hold.
  - e) Sweep = auto couple.
  - f) Allow the trace to stabilize.
  - g) Measure the maximum width of the emission that is constrained by the frequencies associated with the two outermost amplitude points (upper and lower frequencies) that are attenuated by 6 dB relative to the maximum level measured in the fundamental emission.

#### 5.3.2 DEVIATION FROM STANDARD

No deviation.

#### 5.3.3 TEST SETUP



#### 5.3.4 EUT OPERATION CONDITIONS

The EUT tested system was configured as the statements of 2.4 Unless otherwise a special operating condition is specified in the follows during the testing.

#### 5.3.5 TEST RESULTS

Note: 1. ANT 1 Power > ANT 2 Power, Both ANT1 and 2 have been test, Only show the worst data of ANT 1.

2. The test data please reference to attachment "STS2310103W04\_Appendix 5G WIFI".

## 6. MAXIMUM CONDUCTED OUTPUT POWER

### 6.1 LIMIT

For mobile and portable client devices in the 5.15-5.25 GHz band, the maximum conducted output power over the frequency band of operation shall not exceed 250 mW provided the maximum antenna gain does not exceed 6 dBi. If transmitting antennas of directional gain greater than 6 dBi are used, both the maximum conducted output power and the maximum power spectral density shall be reduced by the amount in dB that the directional gain of the antenna exceeds 6 dBi.

For the 5.25-5.35 GHz and 5.47-5.725 GHz bands, the maximum conducted output power over the frequency bands of operation shall not exceed the lesser of 250 mW or  $11 \text{ dBm} + 10 \log B$ , where B is the 26 dB emission bandwidth in megahertz, If transmitting antennas of directional gain greater than 6 dBi are used.

For the band 5.725-5.85 GHz, the maximum conducted output power over the frequency band of operation shall not exceed 1 W. If transmitting antennas of directional gain greater than 6 dBi are used.

FCC Part15 (15.407) , Subpart E				
Section	Test Item	Limit	Frequency Range (MHz)	Result
15.407(a) (1) (iv)	Peak Output Power	0.25 watt	5150-5250	PASS
		The lesser of 250 mW or $11 \text{ dBm} + 10 \log (26 \text{ dB emission bandwidth})$	5250-5350 5470-5725	
15.407(a) (3)		1 watt	5725-5895	

### 6.2 TEST PROCEDURE

The EUT was directly connected to the Power Sensor&PC

### 6.3 DEVIATION FROM STANDARD

No deviation.

### 6.4 TEST SETUP

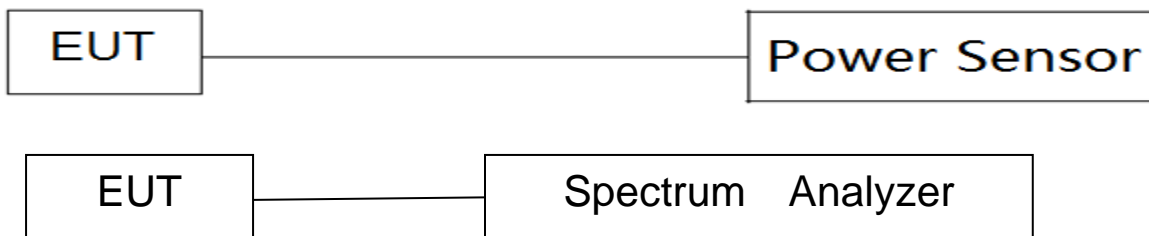

### 6.5 EUT OPERATION CONDITIONS

The EUT tested system was configured as the statements of 5 Unless otherwise a special operating condition is specified in the follows during the testing.

### 6.6 TEST RESULTS

Note: The test data please reference to attachment "STS2310103W04\_Appendix 5G WIFI".



## **7. AUTOMATICALLY DISCONTINUE TRANSMISSION**

### **7.1 LIMIT OF AUTOMATICALLY DISCONTINUE TRANSMISSION**

The device shall automatically discontinue transmission in case of either absence of information to transmit or operational failure. These provisions are not intended to preclude the transmission of control or signaling information or the use of repetitive codes used by certain digital technologies to complete frame or burst intervals. Applicants shall include in their application for equipment authorization to describe how this requirement is met.

### **7.2 TEST RESULT OF AUTOMATICALLY DISCONTINUE TRANSMISSION**

During no any information transmission, the EUT can automatically discontinue transmission and become standby mode for power saving. The EUT can detect the controlling signal of ACK message transmitting from remote device and verify whether it shall resend or discontinue transmission



## **8. ANTENNA REQUIREMENT**

### **8.1 STANDARD REQUIREMENT**

15.203 requirement: For intentional device, according to 15.203: an intentional radiator shall be designed to ensure that no antenna other than that furnished by the responsible party shall be used with the device.

### **8.2 EUT ANTENNA**

The EUT antenna is External Antenna. It comply with the standard requirement.



## APPENDIX - PHOTOS OF TEST SETUP

Note: See test photos in setup photo document for the actual connections between Product and support equipment.

\*\*\*\*\*END OF THE REPORT\*\*\*\*\*