



RADIO TEST REPORT

Report No.: STS2106140W02

Issued for

Aeotec Limited

OFFICE 4 10/F KWAN CHART TOWER NO. 6 TONNOCHY ROAD WANCHAI HK

Product Name:	aërQ Temperature & Humidity Sensor
Brand Name:	Aeotec
Model Name:	ZWA039-A
Series Model:	N/A
FCC ID:	2AOGIZWA039
Test Standard:	FCC Part 15.249

Any reproduction of this document must be done in full. No single part of this document may be reproduced without permission from STS, All Test Data Presented in this report is only applicable to presented Test sample.





TEST RESULT CERTIFICATION

Applicant's Name: Aeotec Limited
Address: OFFICE 4 10/F KWAN CHART TOWER NO. 6 TONNOCHY ROAD WANCHAI HK
Manufacture's Name: Alightum Tech Ltd.
Address: Floor 6, Building A, Wanhe Technology Building, No.7, Huitong Road, Fenghuang Community, Fenghuang Street, Guangming District, Shenzhen

Product Description

Product Name: aërQ Temperature & Humidity Sensor
Brand Name: Aeotec
Model Name: ZWA039-A
Series Model: N/A
Test Standards.....: FCC Part15.249
Test Procedure: ANSI C63.10-2013

This device described above has been tested by STS, the test results show that the equipment under test (EUT) is in compliance with the FCC requirements. And it is applicable only to the tested sample identified in the report.
This report shall not be reproduced except in full, without the written approval of STS, this document only be altered or revised by STS, personal only, and shall be noted in the revision of the document.

Date of Test:
Date of receipt of test item: 22 June 2021
Date of performance of tests...: 22 June 2021 ~ 02 July 2021
Date of Issue: 02 July 2021
Test Result.....: Pass

Testing Engineer : [Signature]
(Chris Chen)

Technical Manager : [Signature]
(Sean she)

Authorized Signatory : [Signature]
(Vita Li)





Table of Contents	Page
1. SUMMARY OF TEST RESULTS	5
1.1 TEST FACTORY	6
1.2 MEASUREMENT UNCERTAINTY	6
2. GENERAL INFORMATION	7
2.1 GENERAL DESCRIPTION OF THE EUT	7
2.2 DESCRIPTION OF THE TEST MODES	8
2.3 TEST SOFTWARE AND POWER LEVEL	8
2.4 BLOCK DIGRAM SHOWING THE CONFIGURATION OF SYSTEM TESTED	8
2.5 DESCRIPTION OF NECESSARY ACCESSORIES AND SUPPORT UNITS	9
2.6 EQUIPMENTS LIST FOR ALL TEST ITEMS	10
3. EMC EMISSION TEST	12
3.1 CONDUCTED EMISSION MEASUREMENT	12
3.2 RADIATED EMISSION MEASUREMENT	15
4. BANDWIDTH TEST	32
4.2 TEST SETUP	32
4.3 EUT OPERATION CONDITIONS	32
4.4 TEST RESULTS	33
5. ANTENNA REQUIREMENT	35
5.1 STANDARD REQUIREMENT	35
5.2 EUT ANTENNA	35
APPENDIX- PHOTOS OF TEST SETUP	36



Revision History

Rev.	Issue Date	Report NO.	Effect Page	Contents
00	02 July 2021	STS2106140W02	ALL	Initial Issue





1. SUMMARY OF TEST RESULTS

Test procedures according to the technical standards:

FCC Part 15.249 , Subpart C			
Standard Section	Test Item	Judgment	Remark
15.207	Conducted Emission	N/A	
15.203	Antenna Requirement	Pass	
15.249	Radiated Spurious Emission	Pass	
15.205	Radiated Band Edge Emission	Pass	
15.249	20dB Bandwidth	Pass	

NOTE:

- (1) 'N/A' denotes test is not applicable in this Test Report.
- (2) All tests are according to ANSI C63.10-2013.

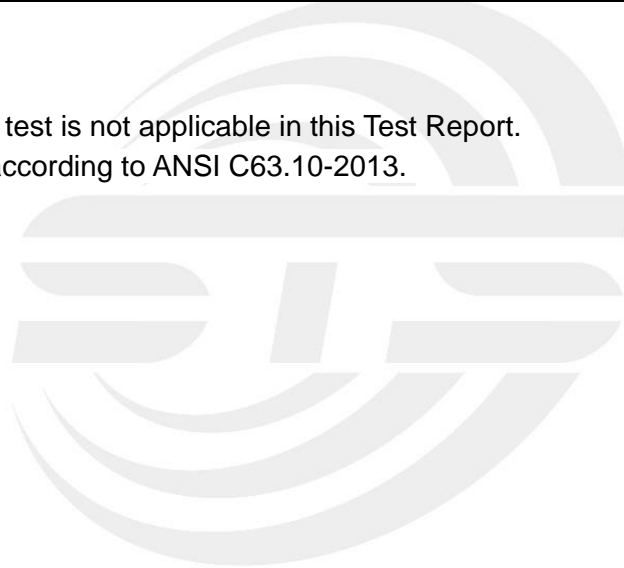



1.1 TEST FACTORY

SHENZHEN STS TEST SERVICES CO., LTD

Add. : A 1/F, Building B, Zhuoke Science Park, No.190 Chongqing Road, HepingShequ, Fuyong Sub-District, Bao'an District, Shenzhen, Guang Dong, China

FCC test Firm Registration Number: 625569

IC test Firm Registration Number: 12108A

A2LA Certificate No.: 4338.01

1.2 MEASUREMENT UNCERTAINTY

The reported uncertainty of measurement $y \pm U$, where expanded uncertainty U is based on a standard uncertainty multiplied by a coverage factor of $k=2$, providing a level of confidence of approximately **95 %**.

No.	Item	Uncertainty
1	RF output power, conducted	$\pm 0.68\text{dB}$
2	Unwanted Emissions, conducted	$\pm 2.988\text{dB}$
3	All emissions, radiated 9K-30MHz	$\pm 2.68\text{dB}$
4	All emissions, radiated 30M-1GHz	$\pm 4.39\text{dB}$
5	All emissions, radiated 1G-6GHz	$\pm 5.10\text{dB}$
6	All emissions, radiated >6G	$\pm 5.48\text{dB}$
7	Conducted Emission (9KHz-150KHz)	$\pm 2.79\text{dB}$
8	Conducted Emission (150KHz-30MHz)	$\pm 2.80\text{dB}$

2. GENERAL INFORMATION

2.1 GENERAL DESCRIPTION OF THE EUT

Product Name	aërQ Temperature & Humidity Sensor
Trade Name	Aeotec
Model Name	ZWA039-A
Series Model	N/A
Model Difference	N/A
Product Description	The EUT is a aërQ Temperature & Humidity Sensor
	Operation Frequency: 908.4MHz-916MHz
	Modulation Type: FSK
	Antenna Designation: Please refer to the Note 3.
	Antenna Gain(Peak): 4dBi
Based on the application, features, or specification exhibited in User Manual, the EUT is considered as an ITE/Computing Device. More details of EUT technical specification, please refer to the User Manual.	
Channel List	Please refer to the Note 2.
Battery	Rated Voltage: 3V Capacity: 1000mAh
Hardware version number	V1.0
Software version number	V1.0
Connecting I/O Port(s)	Please refer to the Note 1.

Note:

1. For a more detailed features description, please refer to the manufacturer's specifications or the User Manual.

2.

Channel List					
Channel	Frequency (MHz)	Channel	Frequency (MHz)	Channel	Frequency (MHz)
01	908.4	02	908.42	03	916

3. Table for Filed Antenna

Ant	Brand	Model Name	Antenna Type	Connector	Gain (dBi)	NOTE
1	Aeotec	ZWA039-A	Monopole	N/A	4dBi	Antenna

2.2 DESCRIPTION OF THE TEST MODES

For conducted test items and radiated spurious emissions
 Each of these EUT operation mode(s) or test configuration mode(s) mentioned below was evaluated respectively.

Pretest Mode	Description	Data/Modulation
Mode 1	TX(908.4MHz)	FSK
Mode 2	TX(908.42MHz)	FSK
Mode 3	TX(916MHz)	FSK

Note:

- (1) All above mode have been measurement, only worst data was reported.
- (2) We have be tested for all avaiable U.S. voltage and frequencies(For 120V,50/60Hz and 240V, 50/60Hz) for which the device is capable of operation, and the worst case of 120V,50/60Hz is shown in the report.

2.3 TEST SOFTWARE AND POWER LEVEL

During testing channel & power controlling software provided by the customer was used to control the operating channel as well as the output power level.

RF Function	Type	Mode Or Modulation type	ANT Gain(dBi)	Power Class	Software For Testing
Other SRD	908.4-916MHz	FSK	4	145	Serial Port Utility

2.4 BLOCK DIGRAM SHOWING THE CONFIGURATION OF SYSTEM TESTED

During testing channel & power controlling software provided by the customer was used to control the operating channel as well as the output power level. The RF output power selection is for the setting of RF output power expected by the customer and is going to be fixed on the firmware of the final end product power parameters.

Radiated Spurious Emission Test

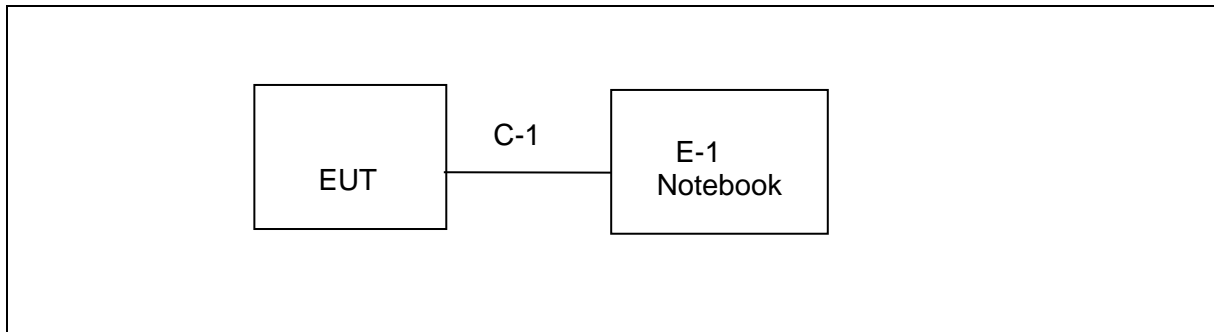



2.5 DESCRIPTION OF NECESSARY ACCESSORIES AND SUPPORT UNITS

The EUT has been tested as an independent unit together with other necessary accessories or support units. The following support units or accessories were used to form a representative test configuration during the tests.

Necessary accessories

Item	Equipment	Mfr/Brand	Model/Type No.	Length	Note
N/A	N/A	N/A	N/A	N/A	N/A

Support units

Item	Equipment	Mfr/Brand	Model/Type No.	Length	Note
E-1	Notebook	LENOVO	ThinkPad E470	N/A	N/A
C-1	USB Cable	N/A	N/A	100cm	NO

Note:

- (1) The support equipment was authorized by Declaration of Confirmation.
- (2) For detachable type I/O cable should be specified the length in cm in 『Length』 column.



2.6 EQUIPMENTS LIST FOR ALL TEST ITEMS

Radiation Test equipment

Kind of Equipment	Manufacturer	Type No.	Serial No.	Last calibration	Calibrated until
Test Receiver	R&S	ESCI	101427	2020.10.12	2021.10.11
Signal Analyzer	R&S	FSV 40-N	101823	2020.10.10	2021.10.09
Active loop Antenna	ZHINAN	ZN30900C	16035	2019.07.11	2021.07.10
Bilog Antenna	TESEQ	CBL6111D	34678	2020.10.12	2022.10.11
Horn Antenna	SCHWARZBECK	BBHA 9120D	02014	2019.10.15	2021.10.14
SHF-EHF Horn Antenna (18G-40GHz)	A-INFO	LB-180400-KF	J211020657	2020.10.12	2022.10.11
Pre-Amplifier (0.1M-3GHz)	EM	EM330	060665	2020.10.12	2021.10.11
Pre-Amplifier (1G-18GHz)	SKET	LNPA-01018G-45	SK2018080901	2020.10.12	2021.10.11
Pre-Amplifier (18G-40GHz)	SKET	LNPA-1840-50	SK2018101801	2020.10.10	2021.10.09
Temperature & Humidity	HH660	Mieo	N/A	2020.10.13	2021.10.12
Turn table	EM	SC100_1	60531	N/A	N/A
Antenna mast	EM	SC100	N/A	N/A	N/A
Test SW	FARAD	EZ-EMC(Ver.STSLAB-03A1 RE)			

Conduction Test equipment

Kind of Equipment	Manufacturer	Type No.	Serial No.	Last calibration	Calibrated until
Test Receiver	R&S	ESCI	101427	2020.10.12	2021.10.11
LISN	R&S	ENV216	101242	2020.10.12	2021.10.11
LISN	EMCO	3810/2NM	23625	2020.10.12	2021.10.11
Temperature & Humidity	HH660	Mieo	N/A	2020.10.13	2021.10.12
Test SW	FARAD	EZ-EMC(Ver.STSLAB-03A1 RE)			



RF Connected Test

Kind of Equipment	Manufacturer	Type No.	Serial No.	Last calibration	Calibrated until
Power Sensor	Keysight	U2021XA	MY55520005	2020.10.10	2021.10.09
			MY55520006	2020.10.10	2021.10.09
			MY56120038	2020.10.10	2021.10.09
			MY56280002	2020.10.10	2021.10.09
Signal Analyzer	Agilent	N9020A	MY51110105	2021.03.04	2022.03.03
Temperature & Humidity	HH660	Mieo	N/A	2020.10.13	2021.10.12
Test SW	FARAD	EZ-EMC(Ver.STSLAB-03A1 RE)			



3. EMC EMISSION TEST

3.1 CONDUCTED EMISSION MEASUREMENT

3.1.1 POWER LINE CONDUCTED EMISSION LIMITS

Operating frequency band. In case the emission fall within the restricted band specified on Part 15.249 limit in the table below has to be followed.

FREQUENCY (MHz)	Quasi-peak	Average
0.15 -0.5	66 - 56 *	56 - 46 *
0.50 -5.0	56.00	46.00
5.0 -30.0	60.00	50.00

Note:

- (1) The tighter limit applies at the band edges.
- (2) The limit of “ * ” marked band means the limitation decreases linearly with the logarithm of the frequency in the range.

The following table is the setting of the receiver

Receiver Parameters	Setting
Attenuation	10 dB
Start Frequency	0.15 MHz
Stop Frequency	30 MHz
IF Bandwidth	9 kHz

3.1.2 TEST PROCEDURE

- a. The EUT was 0.8 meters from the horizontal ground plane and 0.4 meters from the vertical ground plane with EUT being connected to the power mains through a line impedance stabilization network (LISN). All other support equipments powered from additional LISN(s). The LISN provide 50 Ohm/ 50uH of coupling impedance for the measuring instrument.
- b. Interconnecting cables that hang closer than 40 cm to the ground plane shall be folded back and forth in the center forming a bundle 30 to 40 cm long.
- c. I/O cables that are not connected to a peripheral shall be bundled in the center. The end of the cable may be terminated, if required, using the correct terminating impedance. The overall length shall not exceed 1 m.
- d. LISN at least 80 cm from nearest part of EUT chassis.
- e. For the actual test configuration, please refer to the related Item –EUT Test Photos.

3.1.3 TEST SETUP

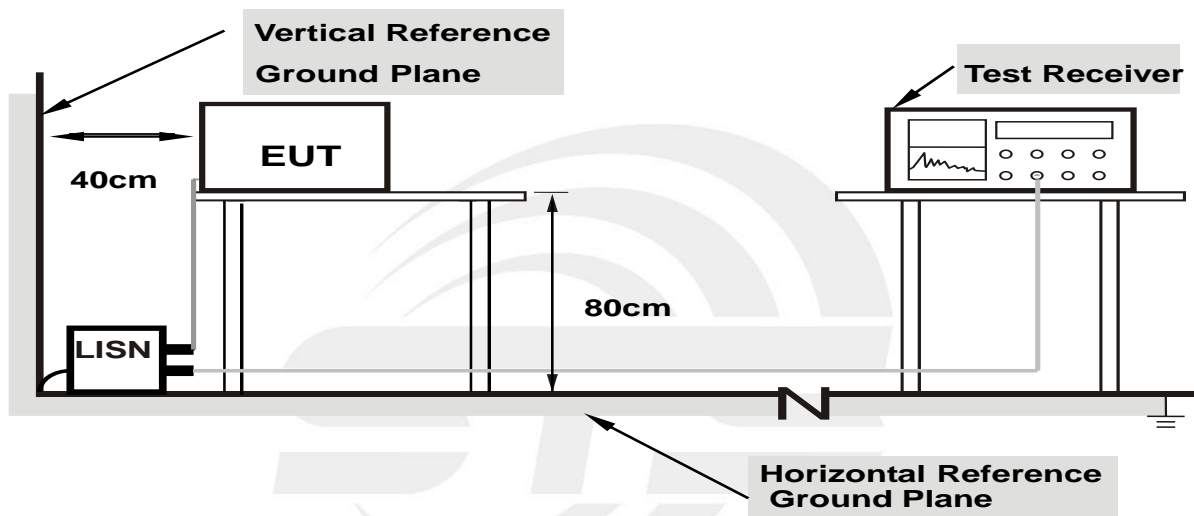

- Note: 1.Support units were connected to second LISN.**
2.Both of LISNs (AMN) are 80 cm from EUT and at least 80 from other units and other metal planes

3.1.4 EUT OPERATING CONDITIONS

The EUT was configured for testing in a typical fashion (as a customer would normally use it). The EUT has been programmed to continuously transmit during test. This operating condition was tested and used to collect the included data.



3.1.5 TEST RESULT

Temperature:	--(C)	Relative Humidity:	--%RH
Test Voltage:	--	Phase:	L/N
Test Mode:	--		

Note: EUT is only power by battery, So it is not applicable for this test.





3.2 RADIATED EMISSION MEASUREMENT

3.2.1 RADIATED EMISSION LIMITS

20dBc in any 100 kHz bandwidth outside the operating frequency band. In case the emission fall within the restricted band specified on Part 15.249 and the Part 15.209(a) limit in the table below has to be followed.

Standard FCC 15.209

Frequencies (MHz)	Field Strength (micovolts/meter)	Measurement Distance (meters)
0.009~0.490	2400/F(KHz)	300
0.490~1.705	24000/F(KHz)	30
1.705~30.0	30	30
30~88	100	3
88~216	150	3
216~960	200	3
960~1000	500	3
Above 1000	Other:74.0 dB(μ V)/m (Peak) 54.0 dB(μ V)/m (Average)	3

Standard FCC 15.249

Frequency of Emission (MHz)	Field Strength of fundamental (millivolts /meter)	Field Strength of Harmonics (microvolts/meter)
900~928	50	500
2400~2483.5	50	500
5725~5875	50	500
24000~242500	250	2500

Notes:

- (1) Emissions radiated outside of the specified frequency bands, except for harmonics, shall be attenuated by at least 50 dB below the level of the fundamental or to the general radiated emission limits in Section 15.209, whichever is the lesser attenuation.

Spectrum Parameter	Setting
Detector	Peak/AV
Attenuation	Auto
Start Frequency	1000 MHz
Stop Frequency	10th carrier harmonic
RB (emission in restricted band)	>20BW
VB (emission in restricted band)	=3xRB



Receiver Parameter	Setting
Attenuation	Auto
Start ~ Stop Frequency	9kHz~90kHz / RB 200Hz for PK & AV
	90kHz~110kHz / RB 200Hz for QP
	110kHz~490kHz / RB 200Hz for PK & AV
	490kHz~30MHz / RB 9kHz for QP
	30MHz~1000MHz / RB 120kHz for QP

3.2.2 TEST PROCEDURE

- a. The measuring distance of 3m shall be used for measurements. The EUT was placed on the top of a rotating table 0.8 meter above the ground at a 3 meter semi-anechoic chamber. The table was rotated 360 degrees to determine the position of the highest radiation (Below 1GHz)
- b. The measuring distance of 3m shall be used for measurements. The EUT was placed on the top of a rotating table 1.5 meter above the ground at a 3 meter semi-anechoic chamber. The table was rotated 360 degrees to determine the position of the highest radiation (Above 1GHz)
- c. The height of the test antenna shall vary between 1m to 4m. Both horizontal and vertical polarization of the antenna are set to make the measurement.
- d. The initial step in collecting radiated emission data is a receive peak detector mode. Pre-scanning the measurement frequency range. Significant peaks are then marked and then Quasi Peak detector mode re-measured.
- e. All readings are peak unless otherwise stated QP in column of Note. Peak denoted that the Peak reading complies with the QP limits and then QP Mode measurement didn't perform (Below 1GHz)
- f. All readings are Peak mode value unless otherwise stated AVG in column of Note. If the Peak mode measured value complies with the Peak limits and lower than AVG Limits, the EUT shall be deemed to meet Peak & AVG limits and then only Peak mode was measured, but AVG mode didn't perform. (Above 1GHz)
- g. For the actual test configuration, please refer to the related Item –EUT Test Photos.
Note: Both horizontal and vertical antenna polarities were tested and performed pretest to three orthogonal axes. The worst case emissions were reported.

3.2.3 DEVIATION FROM TEST STANDARD

No deviation

3.2.4 TEST SETUP

(A) Radiated Emission Test-Up Frequency Below 30MHz

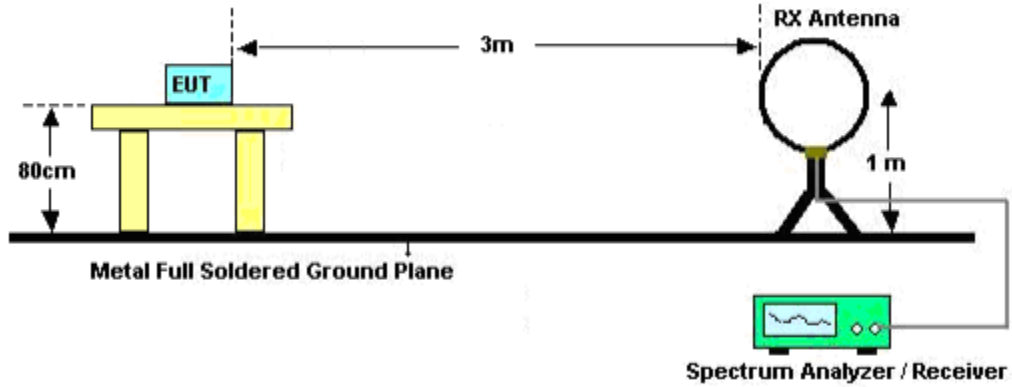

(B) Radiated Emission Test-Up Frequency 30MHz~1GHz

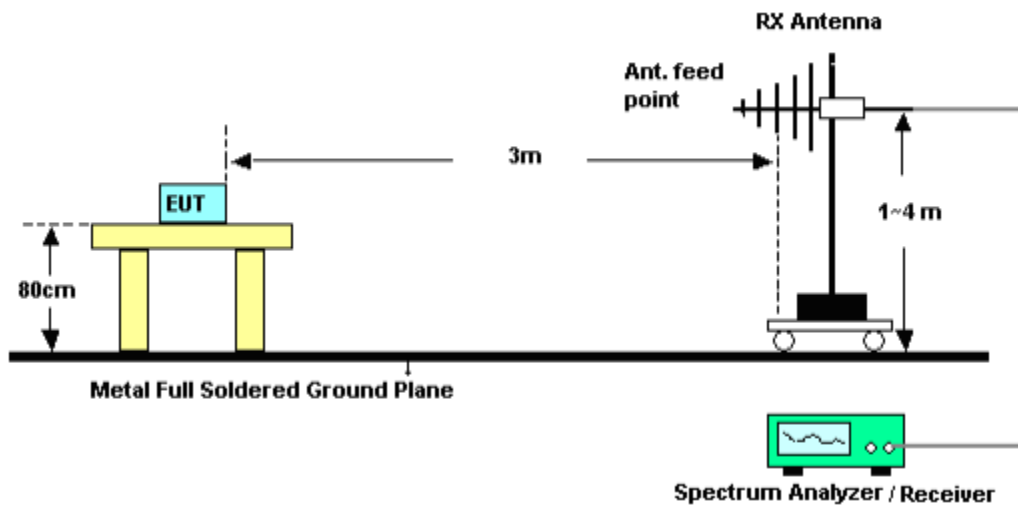

(C) Radiated Emission Test-Up Frequency Above 1GHz

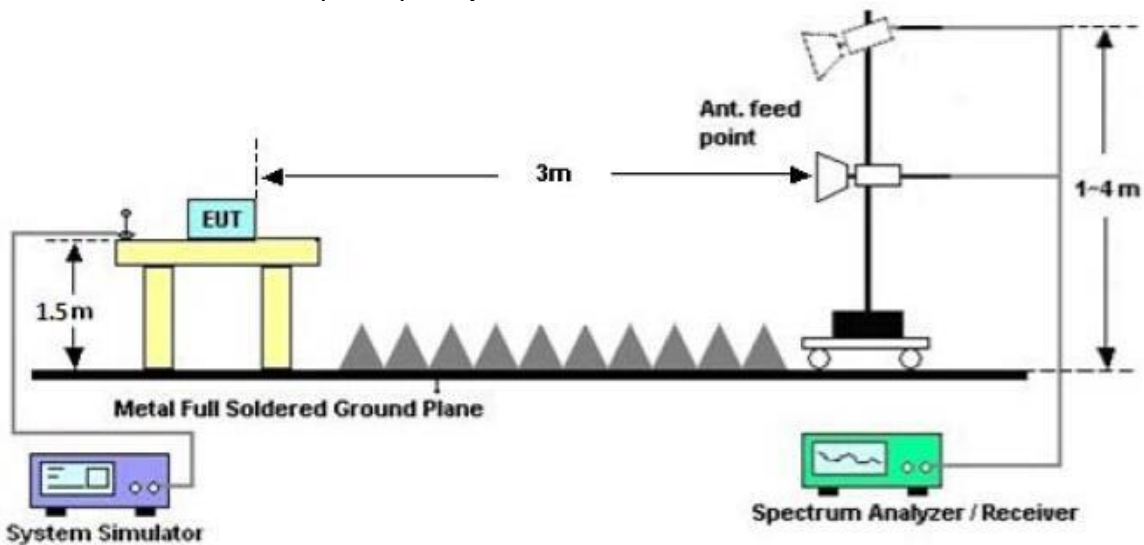



3.2.5 FIELD STRENGTH CALCULATION

The field strength is calculated by adding the Antenna Factor and Cable Factor and subtracting the Amplifier Gain and Duty Cycle Correction Factor (if any) from the measured reading. The basic equation with a sample calculation is as follows:

Margin=PL-PK L or AL- AV L; Margin only shown the worst case.

Where

PR = Peak Reading

AR = Average Reading

PL = Peak Level

AL = Average Level

AF = Antenna Factor

PK L = Peak Limit

AV L = AV Limit

For example

Frequency	PR	AR	AF	PL	AL	PK L	AV L	Margin
(MHz)	(dBμV/m)	(dBμV/m)	(dB)	(dBμV/m)	(dBμV/m)	(dBμV/m)	(dBμV/m)	(dB)
2178	40.23	30.31	9.83	50.06	40.14	74.00	54.00	-13.86





3.2.6 EUT OPERATING CONDITIONS

The EUT tested system was configured as the statements of 2.4 Unless otherwise a special operating condition is specified in the follows during the testing.

Below 30 MHz

Temperature:	23.1(C)	Relative Humidity:	60%RH
Test Voltage:	DC 3.7V	Polarization:	---
Test Mode:	TX Mode		

Freq. (MHz)	Reading (dBuV/m)	Limit (dBuV/m)	Margin (dB)	State P/F
--	--	--	--	PASS
--	--	--	--	PASS

NOTE:

The amplitude of spurious emissions which are attenuated by more than 20dB below the permissible value has no need to be reported.

Distance extrapolation factor = $40 \log (\text{specific distance}/\text{test distance})$ (dB);

Limit line = specific limits(dBuv) + distance extrapolation factor.

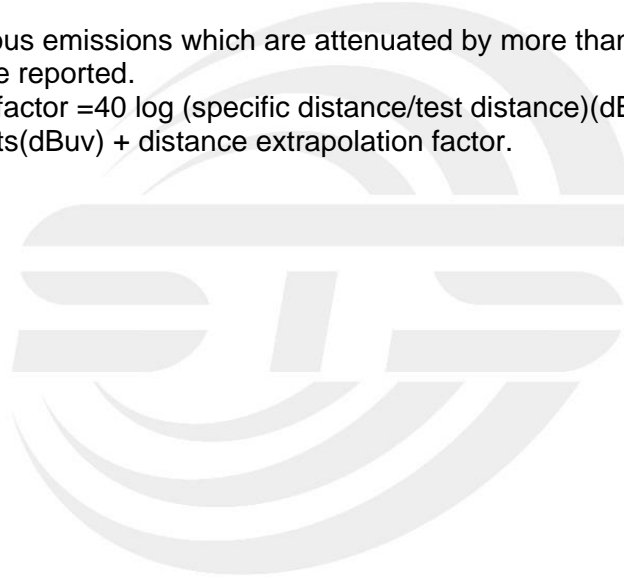



Between 30MHz – 1000 MHz Radiation Spurious

Temperature:	23.1(C)	Relative Humidity:	60%RH
Test Voltage:	DC 3.7V	Phase:	Horizontal
Test Mode:	Mode 1/2/3 (Mode 1 worst mode)		

No.	Frequency (MHz)	Reading (dBuV)	Correct Factor(dB/m)	Result (dBuV/m)	Limit (dBuV/m)	Margin (dB)	Remark
1	131.8500	51.81	-18.20	33.61	43.50	-9.89	QP
2	288.9900	44.07	-15.21	28.86	46.00	-17.14	QP
3	581.9300	31.92	-5.78	26.14	46.00	-19.86	QP
4	733.2500	30.65	-2.35	28.30	46.00	-17.70	QP
5	867.1100	28.77	-0.50	28.27	46.00	-17.73	QP
6	984.4800	27.49	2.40	29.89	54.00	-24.11	QP

Remark:

1. Margin = Result (Result =Reading + Factor)–Limit

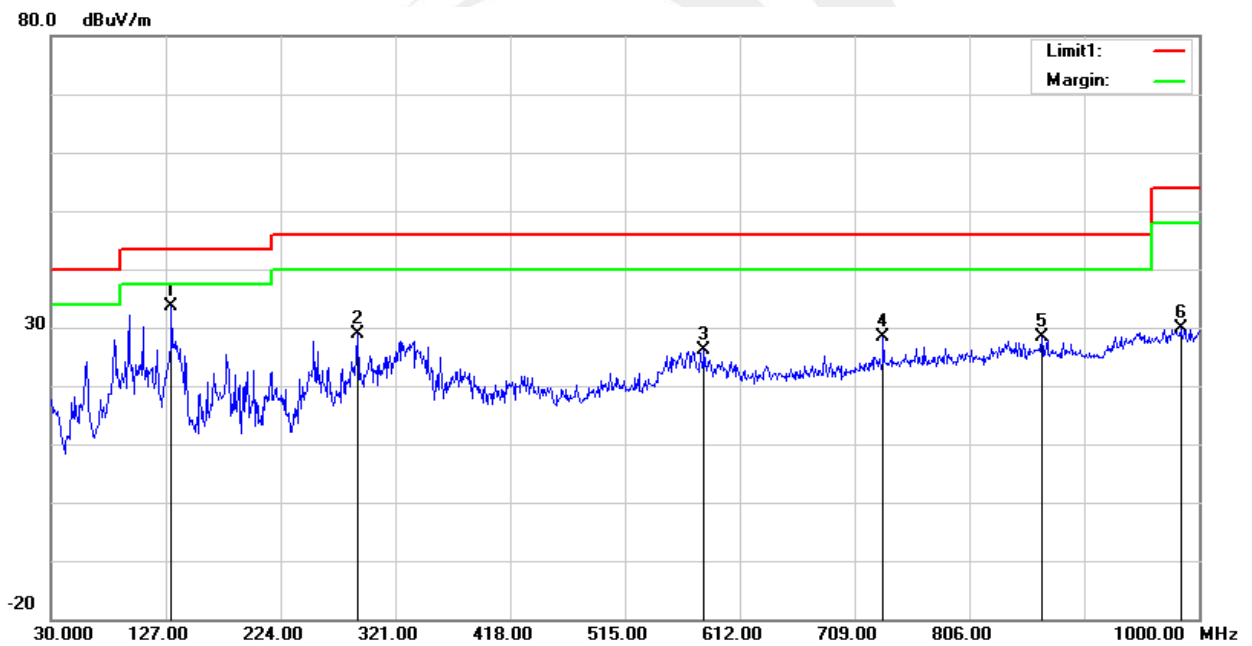



Temperature:	23.1(C)	Relative Humidity:	60%RH
Test Voltage:	DC 3.7V	Phase:	Vertical
Test Mode:	Mode 1/2/3 (Mode 3 worst mode)		

No.	Frequency (MHz)	Reading (dBuV)	Correct Factor(dB/m)	Result (dBuV/m)	Limit (dBuV/m)	Margin (dB)	Remark
1	131.8500	52.57	-18.20	34.37	43.50	-9.13	QP
2	276.3800	44.56	-15.49	29.07	46.00	-16.93	QP
3	555.7400	29.99	-5.60	24.39	46.00	-21.61	QP
4	733.2500	29.33	-2.35	26.98	46.00	-19.02	QP
5	833.1600	30.54	-0.62	29.92	46.00	-16.08	QP
6	980.6000	28.67	2.63	31.30	54.00	-22.70	QP

Remark:

1. Margin = Result (Result =Reading + Factor)–Limit

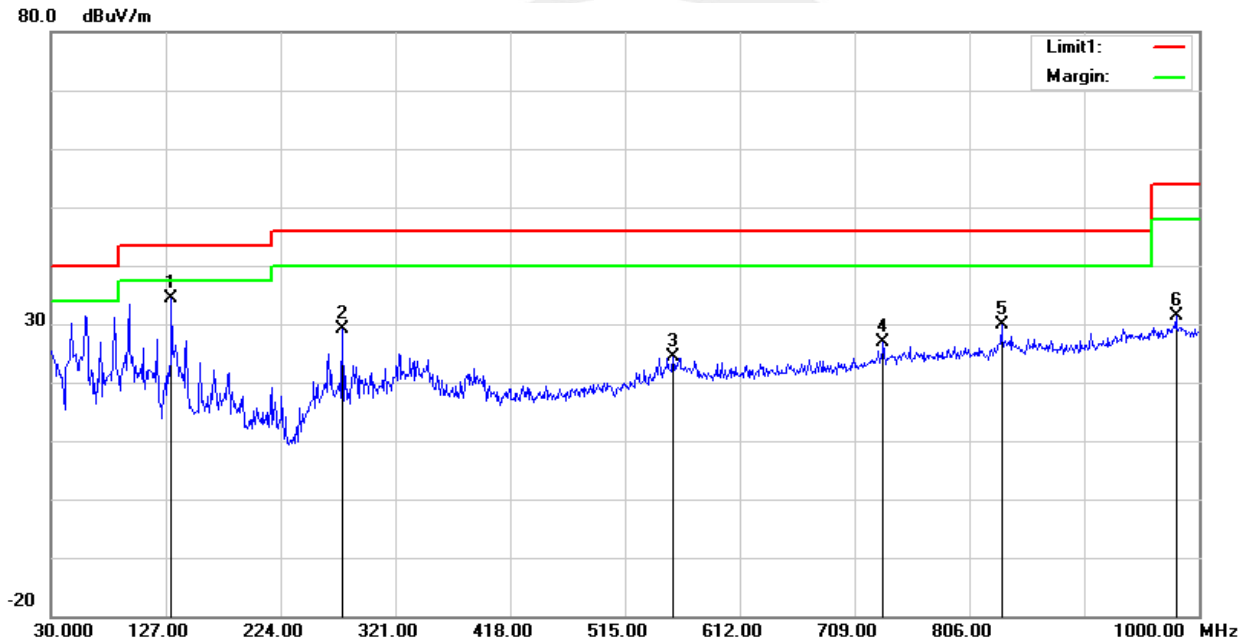



Above 1G Radiation Spurious

908.4MHz

PK

Frequency (MHz)	Meter Reading (dBµV/m)	Detector (PK/QP/AV)	Amplifier (dB)	Loss (dB)	Antenna Factor (dB/m)	Orrected Factor (dB)	Corrected Amplitude (dBµV/m)	FCC Part 15.249/15.209/205		RX Antenna
								Limit (dBµV/m)	Margin (dB)	Polar (H/V)
1816.81	77.68	PK	45.10	4.91	25.00	-15.19	62.49	74	-11.51	H
1816.81	77.20	PK	45.10	4.91	25.00	-15.19	62.01	74	-11.99	V
2725.15	68.30	PK	44.10	5.03	25.80	-13.27	55.03	74	-18.97	H
2725.15	66.86	PK	44.10	5.03	25.80	-13.27	53.59	74	-20.41	V
3633.57	50.89	PK	43.80	6.72	27.20	-9.88	41.01	74	-32.99	H
3633.57	50.53	PK	43.80	6.72	27.20	-9.88	40.65	74	-33.35	V

AV

Frequency (MHz)	PK Reading (dBµV/m)	Duty cycle factor (dB)	AV Reading (dBµV/m)	Orrected Factor (dB)	Corrected Amplitude (dBµV/m)	FCC Part 15.249/15.209/205		RX Antenna
						Limit (dBµV/m)	Margin (dB)	Polar (H/V)
1816.81	77.68	20.26	57.42	-15.19	42.23	54.00	-11.77	H
1816.81	77.20	20.26	56.94	-15.19	41.75	54.00	-12.25	V
2725.15	68.30	20.26	48.04	-13.27	34.77	54.00	-19.23	H
2725.15	66.86	20.26	46.60	-13.27	33.33	54.00	-20.67	V
3633.57	50.89	20.26	30.63	-9.88	20.75	54.00	-33.25	H
3633.57	50.53	20.26	30.27	-9.88	20.39	54.00	-33.61	V

AV = Peak +20Log10(duty cycle factor) =PK-20.26



908.42MHz

PK

Frequency	Meter Reading	Detector	Amplifier	Loss	Antenna Factor	Orrected Factor	Corrected Amplitude	FCC Part 15.249/15.209/205		RX Antenna
								Limit	Margin	Polar
(MHz)	(dBµV/m)	(PK/QP/AV)	(dB)	(dB)	(dB/m)	(dB)	(dBµV/m)	(dBµV/m)	(dB)	(H/V)
1816.96	77.63	PK	45.10	4.91	25.00	-15.19	62.44	74	-11.56	H
1816.96	76.85	PK	45.10	4.91	25.00	-15.19	61.66	74	-12.34	V
2725.19	68.19	PK	44.10	5.03	25.80	-13.27	54.92	74	-19.08	H
2725.19	66.67	PK	44.10	5.03	25.80	-13.27	53.40	74	-20.60	V
3633.54	50.65	PK	43.80	6.72	27.20	-9.88	40.77	74	-33.23	H
3633.54	50.48	PK	43.80	6.72	27.20	-9.88	40.60	74	-33.40	V

AV

Frequency	PK Reading	Duty cycle factor	AV Reading	Orrected Factor	Corrected Amplitude	FCC Part 15.249/15.209/205		RX Antenna
						Limit	Margin	Polar
(MHz)	(dBµV/m)	(dB)	(dBµV/m)	(dB)	(dBµV/m)	(dBµV/m)	(dB)	(H/V)
1816.96	77.63	20.26	57.37	-15.19	42.18	54.00	-11.82	H
1816.96	76.85	20.26	56.59	-15.19	41.40	54.00	-12.60	V
2725.19	68.19	20.26	47.93	-13.27	34.66	54.00	-19.34	H
2725.19	66.67	20.26	46.41	-13.27	33.14	54.00	-20.86	V
3633.54	50.65	20.26	30.39	-9.88	20.51	54.00	-33.49	H
3633.54	50.48	20.26	30.22	-9.88	20.34	54.00	-33.66	V

AV = Peak +20Log10(duty cycle factor) =PK-20.26



916MHz

PK

Frequency	Meter Reading	Detector	Amplifier	Loss	Antenna Factor	Orrected Factor	Corrected Amplitude	FCC Part 15.249/15.209/205		RX Antenna
								Limit	Margin	Polar
(MHz)	(dBµV/m)	(PK/QP/AV)	(dB)	(dB)	(dB/m)	(dB)	(dBµV/m)	(dBµV/m)	(dB)	(H/V)
1832.13	77.97	PK	45.10	4.91	25.00	-15.19	62.78	74	-11.22	H
1832.13	76.91	PK	45.10	4.91	25.00	-15.19	61.72	74	-12.28	V
2748.07	68.16	PK	44.10	5.03	25.80	-13.27	54.89	74	-19.11	H
2748.07	66.75	PK	44.10	5.03	25.80	-13.27	53.48	74	-20.52	V
3664.07	50.82	PK	43.80	6.72	27.20	-9.88	40.94	74	-33.06	H
3664.07	50.83	PK	43.80	6.72	27.20	-9.88	40.95	74	-33.05	V

AV

Frequency	PK Reading	Duty cycle factor	AV Reading	Orrected Factor	Corrected Amplitude	FCC Part 15.249/15.209/205		RX Antenna
						Limit	Margin	Polar
(MHz)	(dBµV/m)	(dB)	(dBµV/m)	(dB)	(dBµV/m)	(dBµV/m)	(dB)	(H/V)
1832.13	77.97	20.26	57.71	-15.19	42.52	54.00	-11.48	H
1832.13	76.91	20.26	56.65	-15.19	41.46	54.00	-12.54	V
2748.07	68.16	20.26	47.90	-13.27	34.63	54.00	-19.37	H
2748.07	66.75	20.26	46.49	-13.27	33.22	54.00	-20.78	V
3664.07	50.82	20.26	30.56	-9.88	20.68	54.00	-33.32	H
3664.07	50.83	20.26	30.57	-9.88	20.69	54.00	-33.31	V

AV = Peak +20Log10(duty cycle factor) =PK-20.26



Duty cycle



Ton	Tp	Duty cycle(%)	Duty factor(dB)
26.800	276.000	9.71%	20.26

Note: Duty Factor=20*LOG10(1/(Ton/Tp))



(Radiation Band edge)

Low channel
Horizontal

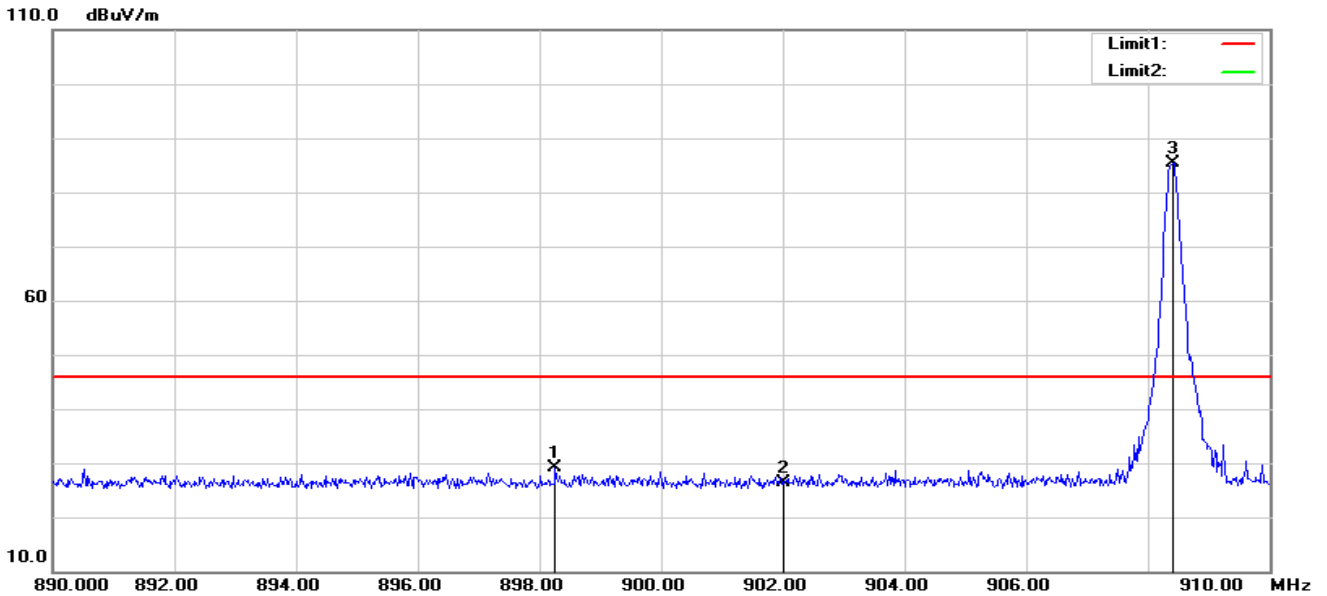

No.	Frequency (MHz)	Reading (dBuV)	Correct Factor(dB/m)	Result (dBuV/m)	Limit (dBuV/m)	Margin (dB)	Remark
1	898.2600	29.50	-0.49	29.01	46.00	-16.99	peak
2	902.0000	26.70	-0.40	26.30	46.00	-19.70	peak

Fundamental Frequency

No.	Frequency (MHz)	Reading (dBuV)	Correct Factor(dB/m)	Duty cycle Factor(dB/m)	Result (dBuV/m)	Limit (dBuV/m)	Margin (dB)	Remark
3	908.4000	85.65	-0.23	-	85.42	94	-8.58	peak



Vertical

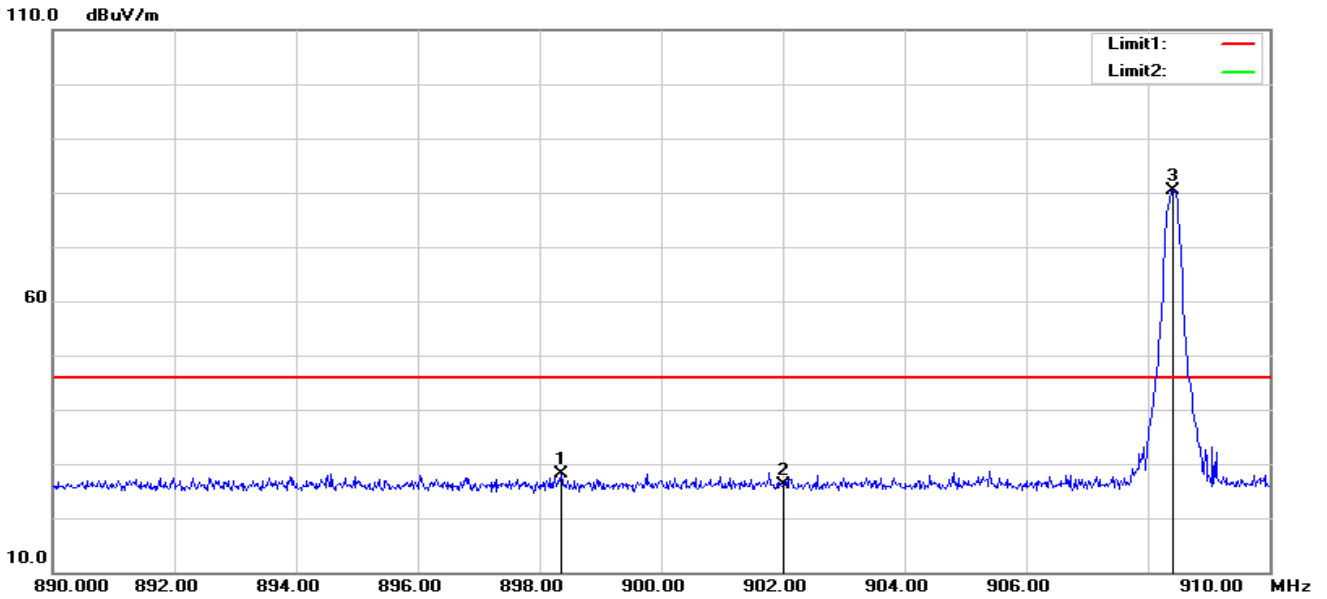

No.	Frequency (MHz)	Reading (dBuV)	Correct Factor(dB/m)	Result (dBuV/m)	Limit (dBuV/m)	Margin (dB)	Remark
1	898.3600	28.67	-0.49	28.18	46.00	-17.82	peak
2	902.0000	26.54	-0.40	26.14	46.00	-19.86	peak

Fundamental Frequency

No.	Frequency (MHz)	Reading (dBuV)	Correct Factor(dB/m)	Duty cycle Factor(dB/m)	Result (dBuV/m)	Limit (dBuV/m)	Margin (dB)	Remark
3	908.4000	80.54	-0.23	-	80.31	94	-13.69	peak



Mid channel
Horizontal

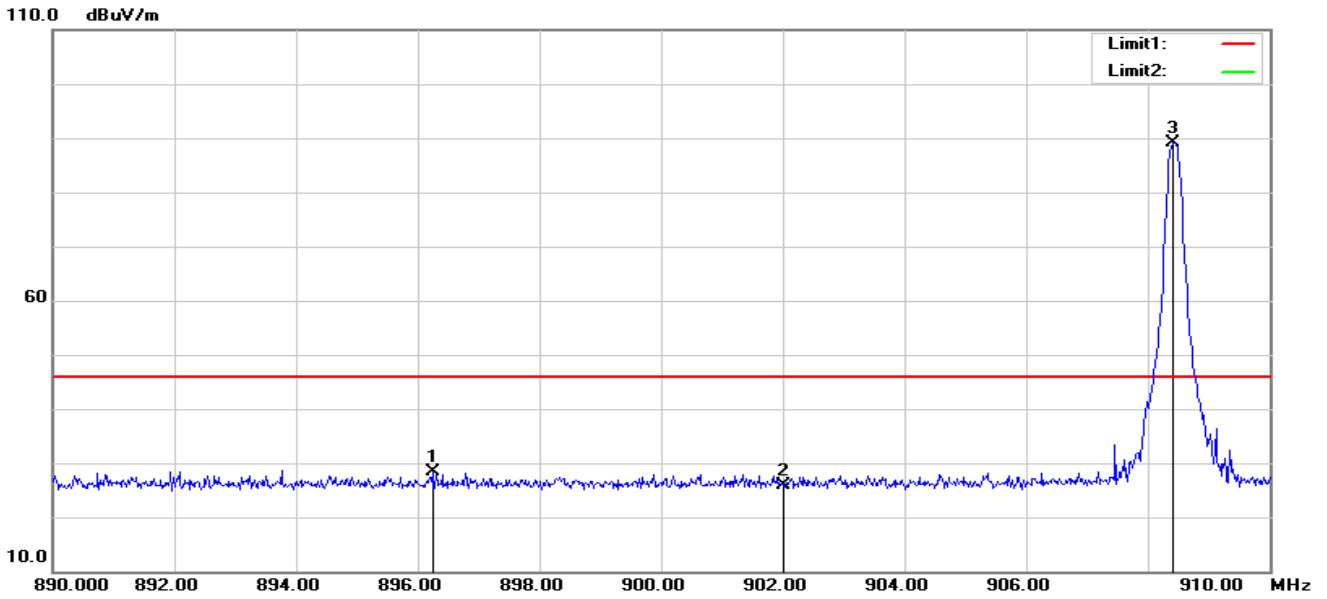

No.	Frequency (MHz)	Reading (dBuV)	Correct Factor(dB/m)	Result (dBuV/m)	Limit (dBuV/m)	Margin (dB)	Remark
1	896.2400	28.99	-0.54	28.45	46.00	-17.55	peak
2	902.0000	26.24	-0.40	25.84	46.00	-20.16	peak

Fundamental Frequency

No.	Frequency (MHz)	Reading (dBuV)	Correct Factor(dB/m)	Duty cycle Factor(dB/m)	Result (dBuV/m)	Limit (dBuV/m)	Margin (dB)	Remark
3	908.4200	89.30	-0.22	-	89.08	94	-4.92	peak



Vertical

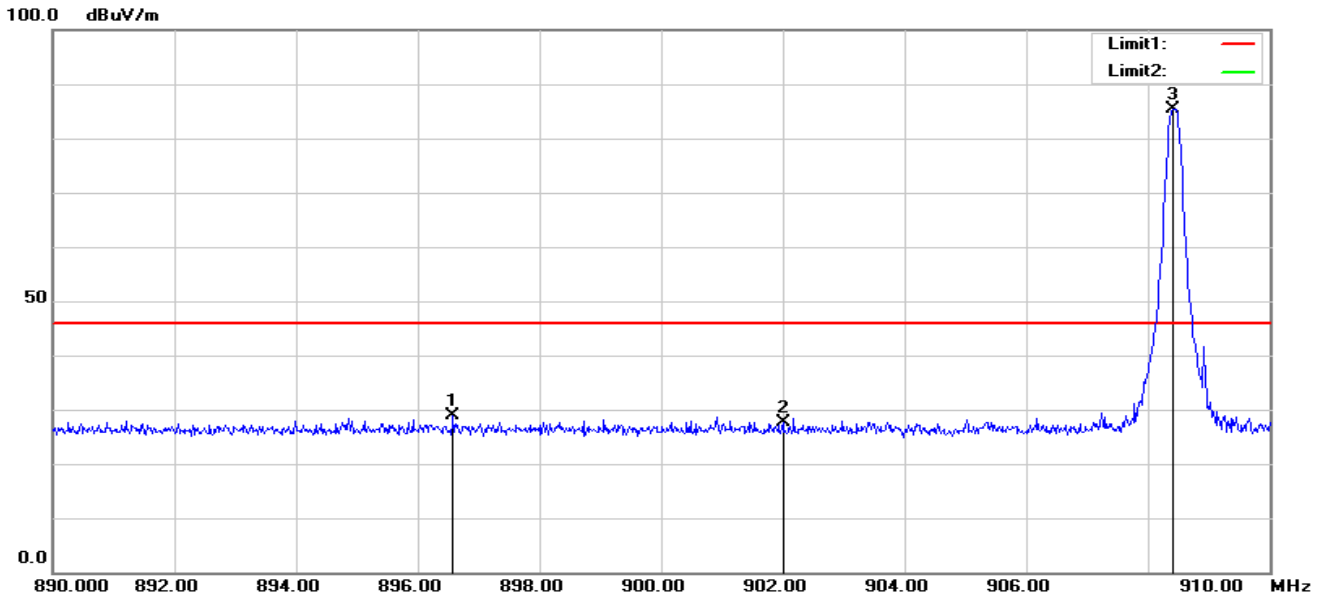

No.	Frequency (MHz)	Reading (dBuV)	Correct Factor(dB/m)	Result (dBuV/m)	Limit (dBuV/m)	Margin (dB)	Remark
1	896.5800	29.37	-0.53	28.84	46.00	-17.16	peak
2	902.0000	28.08	-0.40	27.68	46.00	-18.32	peak

Fundamental Frequency

No.	Frequency (MHz)	Reading (dBuV)	Correct Factor(dB/m)	Duty cycle Factor(dB/m)	Result (dBuV/m)	Limit (dBuV/m)	Margin (dB)	Remark
3	908.4200	85.58	-0.22	-	85.36	94	-8.64	peak



High channel Horizontal

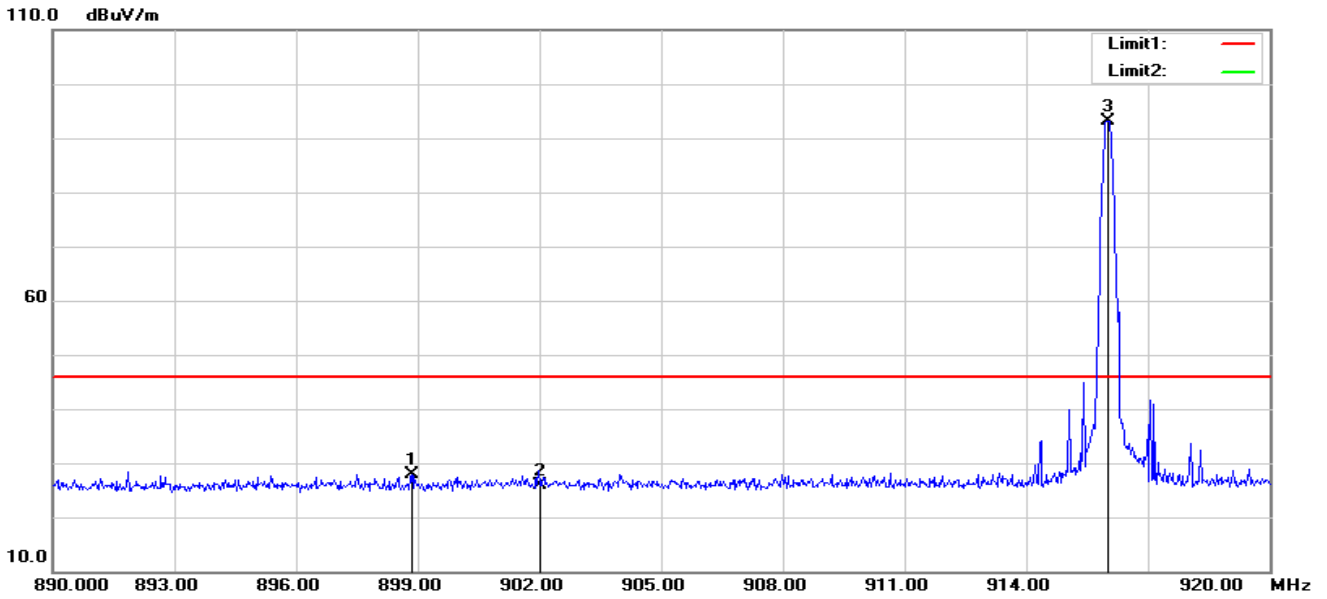

No.	Frequency (MHz)	Reading (dBuV)	Correct Factor(dB/m)	Result (dBuV/m)	Limit (dBuV/m)	Margin (dB)	Remark
1	898.8500	28.47	-0.48	27.99	46.00	-18.01	peak
2	902.0000	26.33	-0.40	25.93	46.00	-20.07	peak

Fundamental Frequency

No.	Frequency (MHz)	Reading (dBuV)	Correct Factor(dB/m)	Duty cycle Factor(dB/m)	Result (dBuV/m)	Limit (dBuV/m)	Margin (dB)	Remark
3	916.0000	93.12	-0.09	-	93.03	94	0.97	peak



Vertical

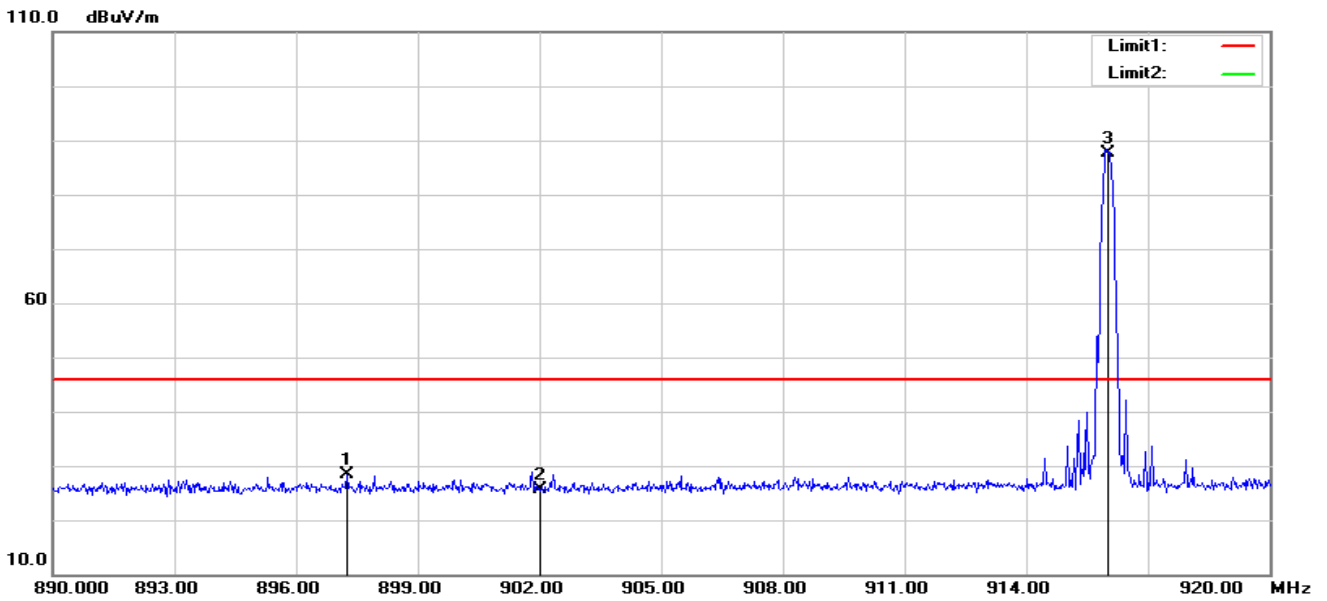

No.	Frequency (MHz)	Reading (dBuV)	Correct Factor(dB/m)	Result (dBuV/m)	Limit (dBuV/m)	Margin (dB)	Remark
1	897.2600	28.95	-0.52	28.43	46.00	-17.57	peak
2	902.0000	25.99	-0.40	25.59	46.00	-20.41	peak
3	916.0000	87.74	-0.09	87.65	46.00	41.65	peak

Fundamental Frequency

No.	Frequency (MHz)	Reading (dBuV)	Correct Factor(dB/m)	Duty cycle Factor(dB/m)	Result (dBuV/m)	Limit (dBuV/m)	Margin (dB)	Remark
3	916.0000	87.74	-0.09	-	87.65	94	-6.45	peak

4. BANDWIDTH TEST

4.1 TEST PROCEDURE

- a. The EUT was directly connected to the spectrum analyzer and antenna output port as show in the block diagram below.
- b. Spectrum Setting : RBW= 1% to 5% of the OBW, VBW \geq 3RBW, Sweep time = Auto.

4.2 TEST SETUP



4.3 EUT OPERATION CONDITIONS

TX mode.





4.4 TEST RESULTS

Temperature:	25 °C	Relative Humidity:	50%
Test Voltage:	DC 3.7V		

Frequency(MHz)	20 dB Bandwidth(KHz)	99% Bandwidth(KHz)
908.4	87.23	88.853
908.42	98.08	84.992
916	119.4	113.39

908.4MHz

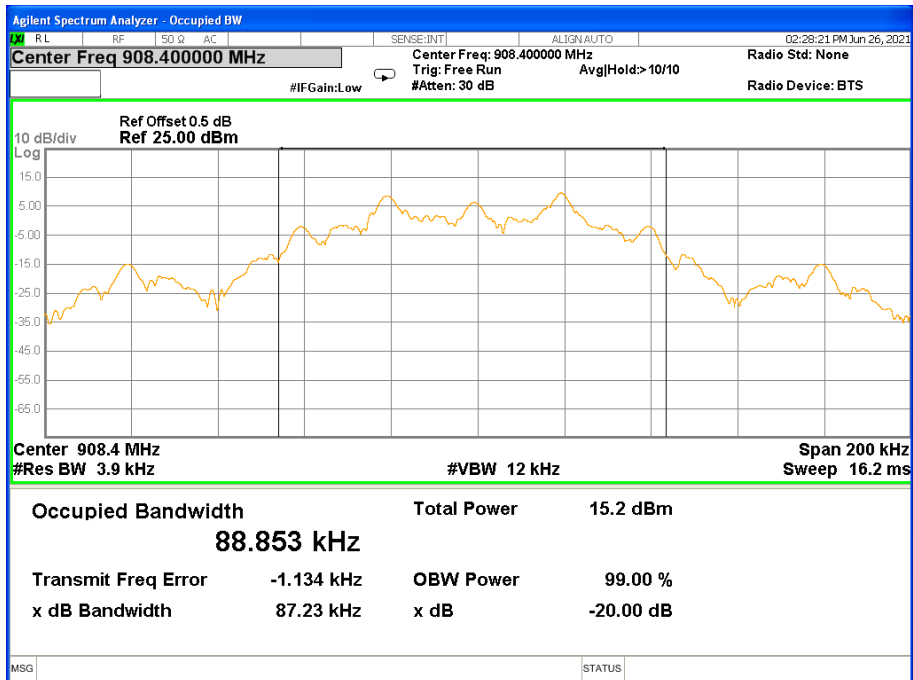



908.42MHz

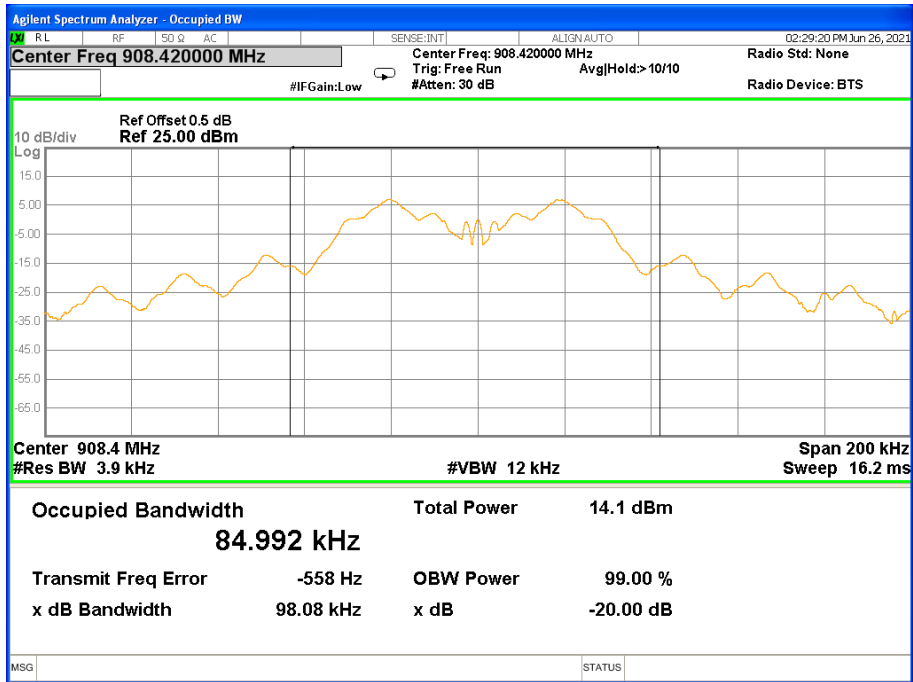

916MHz

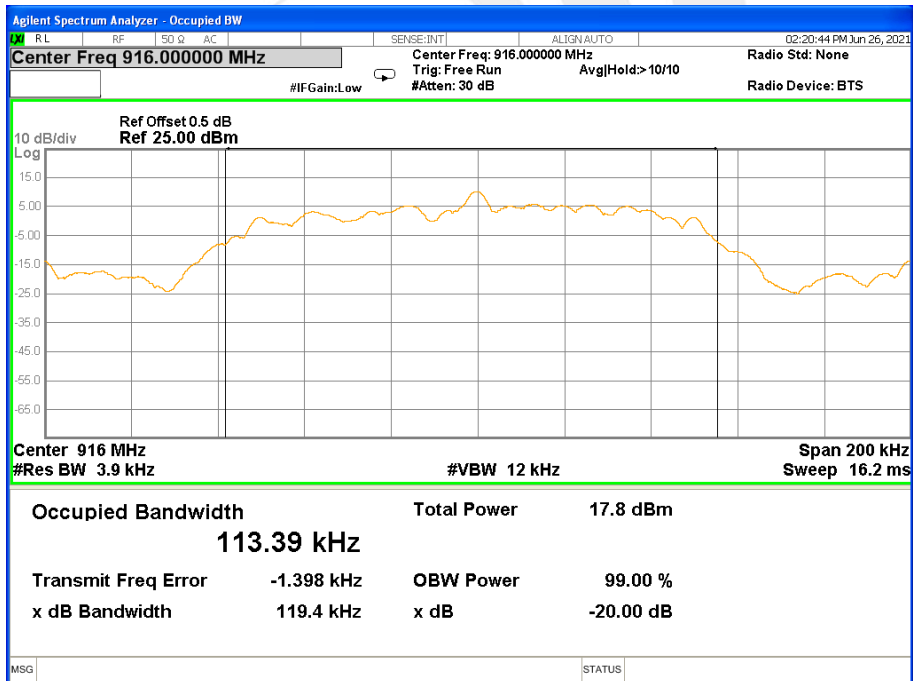



5. ANTENNA REQUIREMENT

5.1 STANDARD REQUIREMENT

According to the FCC Part 15 Paragraph 15.203, an intentional radiator shall be designed to ensure that no antenna other than that furnished by the responsible party shall be used with the device.

5.2 EUT ANTENNA

The EUT antenna is Monopole Antenna. It conforms to the standard requirements.





APPENDIX- PHOTOS OF TEST SETUP

Note: See test photos in setup photo document for the actual connections between Product and support equipment.

*****END OF THE REPORT*****

