



FCC Part 15.247

TEST REPORT

For

Serafim Technologies Inc.

5F., No. 6, Aly. 9, Ln. 45, Baoxing Rd., Xindian Dist., New Taipei City 231, Taiwan (R.O.C.)

FCC ID: 2AOERSGC-S1A

Report Type	Original Report
Product Name:	Serafim S1 Controller
Model Name:	Serafim S1
Report Number :	RXZ200520001-00B
Report Date :	2020/06/19
Reviewed By :	Flight Hsieh <i>Flight.Hsieh</i>
Prepared By:	
Bay Area Compliance Laboratories Corp.(Linkou Laboratory)	
No. 6, Wende 2Rd., Guishan Dist., Taoyuan City 33382, Taiwan (R.O.C.)	
Tel: +886 (3)3961072; Fax: +886 (3) 3961027	
www.bacl.com.tw	

Note: This test report is prepared for the customer shown above and for the device described herein. It may not be duplicated or used in part without prior written consent from Bay Area Compliance Laboratories Corp. (Linkou Laboratory)

Revision History

Revision	Report Number	Issue Date	Description
1.0	RXZ200520001-00B	2020/06/19	Original Report

TABLE OF CONTENTS

1 GENERAL INFORMATION4

1.1 PRODUCT DESCRIPTION FOR EQUIPMENT UNDER TEST (EUT).....4

1.2 OBJECTIVE AND TEST METHODOLOGY.....4

1.3 MEASUREMENT UNCERTAINTY5

1.4 ENVIRONMENTAL CONDITIONS AND TEST DATE5

1.5 TEST FACILITY.....5

2 SYSTEM TEST CONFIGURATION6

2.1 TEST CHANNELS AND DESCRIPTION OF WORST TEST CONFIGURATION.....6

2.2 SUPPORT EQUIPMENT LIST AND EXTERNAL CABLE LIST6

2.3 BLOCK DIAGRAM OF TEST SETUP7

2.4 DUTY CYCLE.....7

3 SUMMARY OF TEST RESULTS.....8

4 FCC§15.247(I), §1.1307, § 2.1093 – RF EXPOSURE9

4.1 APPLICABLE STANDARD9

4.2 RF EXPOSURE EVALUATION RESULT.....9

5 FCC §15.203 - ANTENNA REQUIREMENTS10

5.1 APPLICABLE STANDARD10

5.2 ANTENNA LIST AND DETAILS10

6 FCC §15.207 - AC LINE CONDUCTED EMISSIONS11

6.1 APPLICABLE STANDARD11

6.2 EUT SETUP AND TEST PROCEDURE.....11

6.3 TEST EQUIPMENT LIST AND DETAILS12

6.4 TEST RESULT13

7 FCC §15.209, §15.205, §15.247(D) – SPURIOUS EMISSIONS.....14

7.1 APPLICABLE STANDARD14

7.2 EUT SETUP AND TEST PROCEDURE.....16

7.3 TEST EQUIPMENT LIST AND DETAILS17

7.4 TEST RESULT18

8 FCC §15.247(A)(2) – 6 DB EMISSION BANDWIDTH22

8.1 APPLICABLE STANDARD22

8.2 TEST PROCEDURE.....22

8.3 TEST EQUIPMENT LIST AND DETAILS22

8.4 TEST RESULTS23

9 FCC §15.247(B) (3) – MAXIMUM OUTPUT POWER24

9.1 APPLICABLE STANDARD24

9.2 TEST PROCEDURE.....24

9.3 TEST EQUIPMENT LIST AND DETAILS24

9.4 TEST RESULTS24

10 FCC §15.247(D) – 100 KHZ BANDWIDTH OF FREQUENCY BAND EDGE.....25

10.1 APPLICABLE STANDARD25

10.2 TEST PROCEDURE.....25

10.3 TEST EQUIPMENT LIST AND DETAILS26

10.4 TEST RESULTS26

11 FCC §15.247(E) – POWER SPECTRAL DENSITY27

11.1 APPLICABLE STANDARD27

11.2 TEST PROCEDURE.....27

11.3 TEST EQUIPMENT LIST AND DETAILS27

11.4 TEST RESULTS28

1 General Information

1.1 Product Description for Equipment under Test (EUT)

Applicant	Serafim Technologies Inc. 5F., No. 6, Aly. 9, Ln. 45, Baoxing Rd., Xindian Dist., New Taipei City 231, Taiwan (R.O.C.)
Manufacturer	Serafim Technologies Inc. 5F., No. 6, Aly. 9, Ln. 45, Baoxing Rd., Xindian Dist., New Taipei City 231, Taiwan (R.O.C.)
Brand Name	Serafim
Product (Equipment)	Serafim S1 Controller
Model Name	Serafim S1
Frequency Range	2402 - 2480 MHz
Number of Channels	40 Channels
Output Power	-5.06 dBm (0.0003 W)
Modulation Type	GFSK
Power Operation (Voltage Range)	<input checked="" type="checkbox"/> DC Type <input checked="" type="checkbox"/> DC 3.7Vdc from Battery <input checked="" type="checkbox"/> External from USB Cable: 5Vdc
Related Submittal(s)/Grant(s)	N/A
Received Date	2020-05-20
Date of Test	2020-05-26 – 2020-05-29

**All measurement and test data in this report was gathered from production sample serial number: 20052001 Assigned by BACL, Linkou Laboratory).*

1.2 Objective and Test Methodology

The Objective of this Test Report was to document the compliance of the Serafim Technologies Inc. (Model: MHCWB4P-B) to the requirements of the following Standards:

- Part 2, Subpart J, Part 15, Subparts A and C, section 15.247 of the Federal Communication Commission's rules.
- ANSI C63.10-2013 of the American National Standard of Procedures for Compliance Testing of Unlicensed Wireless Devices.

1.3 Measurement Uncertainty

Parameter	Expanded Measurement uncertainty
RF output power	± 1.488 dB
Occupied Channel Bandwidth	± 453.927 Hz
RF Conducted Emission test	± 2.77 dB
AC Power Line Conducted Emission	± 2.66 dB
Radiated Below 1G	± 3.57 dB
Radiated Above 1G	± 5.32 dB

The test results with statement of conformity, the decision rules are based on the specifications and standards. The test results will not take the measurement uncertainty into

1.4 Environmental Conditions and Test Date

Test Site	Test Date	Temperature (°C)	Relative Humidity (%)	Test Engineer
Conduction (Con-01)	2020-05-29	23.6	56	David Lee
Radiated (966A)	2020-05-26	20.4	55	Leo Cheng
Conducted (TH-02)	2020-05-29	23.2	57	David Lee

1.5 Test Facility

The Test site used by Bay Area Compliance Laboratories Corp. (Linkou Laboratory) to collect test data is located on

No.6, Wende 2Rd., Guishan Dist., Taoyuan City 33382, Taiwan (R.O.C.).

Bay Area Compliance Laboratories Corp. (Linkou Laboratory) Lab is accredited to ISO 17025 by Taiwan Accreditation Foundation (TAF code: 3546) by Mutual Recognition Agreement (MRA). The test site has been approved by the FCC under the KDB 974614 D01 and is listed in the FCC Public Access Link (PAL) database. The FCC Registration No.: 0027578244. Designation No.: TW1119. The Test Firm Registration No.: 311381.

2 System Test Configuration

2.1 Test Channels and Description of Worst Test Configuration

The system was configured for testing in testing mode which was provided by manufacturer.

No special accessory, No modification was made to the EUT and No special equipment used during test.

For BLE, there are totally 40 channels.

Channel	Frequency (MHz)	Channel	Frequency (MHz)
0	2402	20	2442
1	2404	--	--
2	2406	--	--
3	2408	37	2476
--	--	38	2478
19	2440	39	2480

For BLE: Channel 0, 19 and 39 were tested.

The worst-case data rates are determined to be as follows for each mode based upon investigation by measuring the Peak power and PSD across all data rates bandwidths, and modulations. Radiated below 1G were tested worst output power.

Modulation Used for Conformance Test			
Configuration	NTX	Data Rate	Worst Data Rate
BLE	1	125 kbps-1 Mbps	1 Mbps

Worst Case of Power Setting				
EUT Exercise Software		BTool		
Configuration	NTX	Low CH	Mid CH	High CH
BLE	1	Default	Default	Default

2.2 Support Equipment List and External Cable List

No.	Description	Manufacturer	Model Number	Series Number
A	Notebook	DELL	Latitude E6410	PP27LA001
B	Adapter	MYCELL	AC-B04	AC-B04001
C	USB Cable	Shenzhen Mifano	X-JP05051001000011-F	USB Cable

2.3 Block Diagram of Test Setup

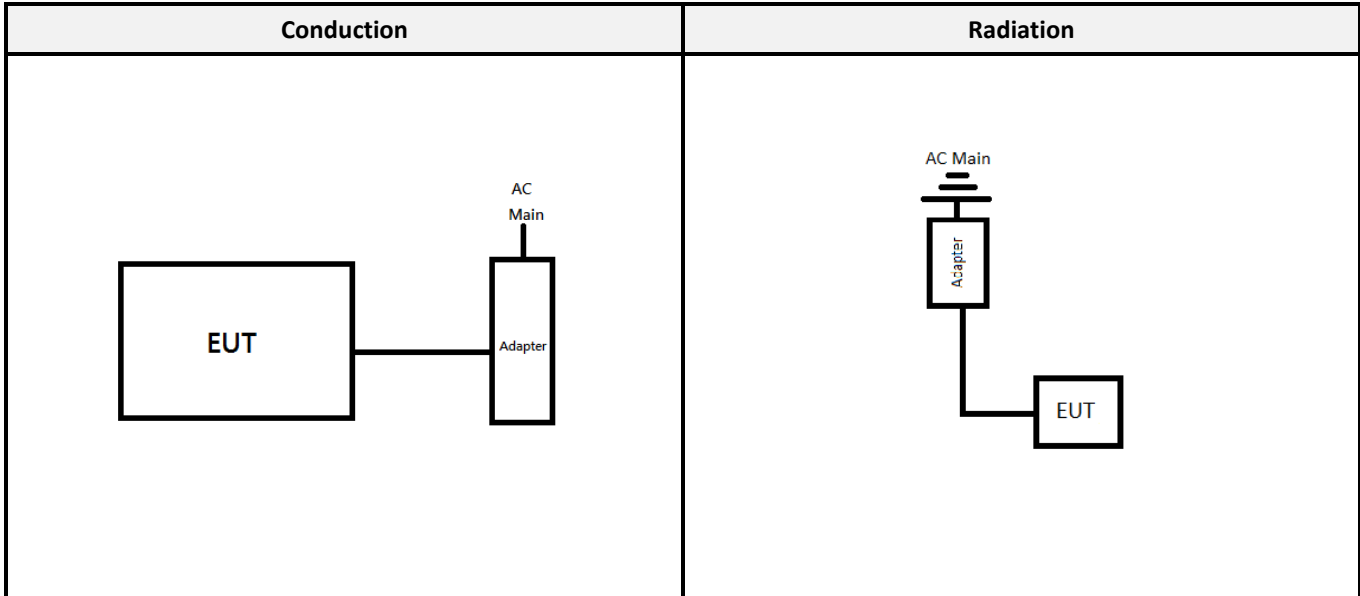

2.4 Duty Cycle

All measurements are to be performed with the EUT transmitting at 100% duty cycle at its maximum power control level; however, if 100% duty cycle cannot be achieved, measurements of duty cycle, x, and maximum power transmission duration, T, are required for each tested mode of operation.

Configuration	On Time (ms)	Period (ms)	Duty Cycle (%)	Duty Factor (dB)
BLE-1Mbps	0.3913	0.6232	62.79	2.02

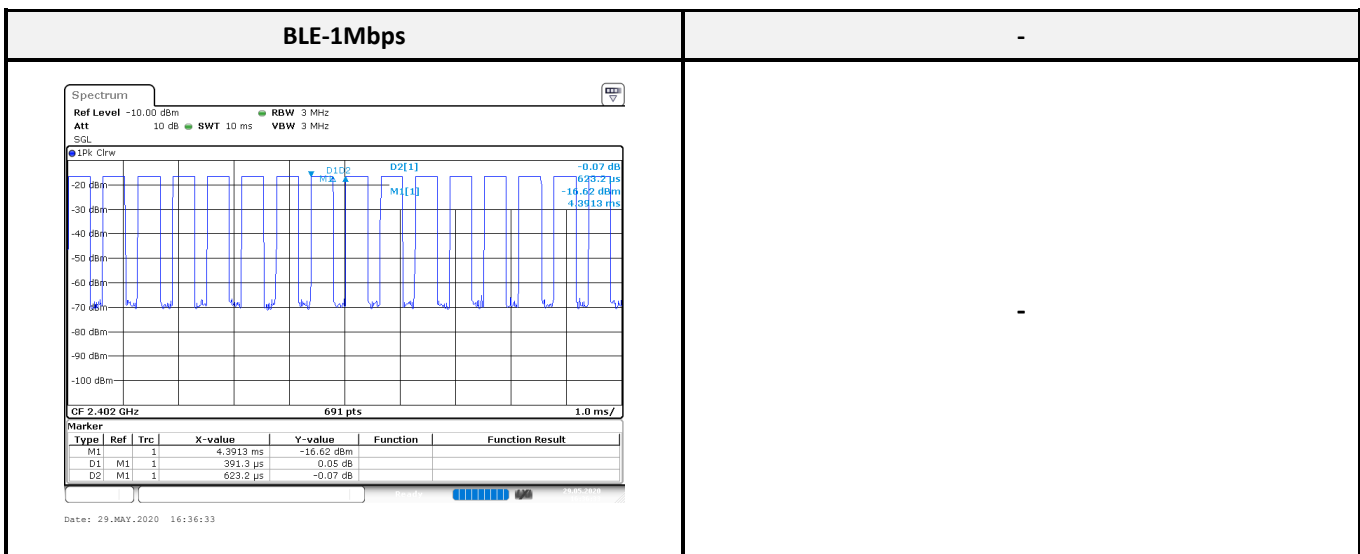

**Note: Duty Factor = 10*log (1/Duty cycle)*

3 Summary of Test Results

FCC Rules	Description of Test	Result
§15.247(i), §1.1307, § 2.1093	RF Exposure	Compliance
§15.203	Antenna Requirement	Compliance
§15.207(a)	AC Line Conducted Emissions	Compliance
§15.205, §15.209, §15.247(d)	Spurious Emissions	Compliance
§15.247(a)(2)	6 dB Emission Bandwidth	Compliance
§15.247(b)(3)	Maximum Peak Output Power	Compliance
§15.247(d)	100 kHz Bandwidth of Frequency Band Edge	Compliance
§15.247(e)	Power Spectral Density	Compliance

4 FCC§15.247(i), §1.1307, § 2.1093 – RF Exposure

4.1 Applicable Standard

According to FCC §2.1093 and §1.1307(b) (1), systems operating under the provisions of this section shall be operated in a manner that ensure that the public is not exposed to radio frequency energy level in excess of the Commission’s guideline.

According to KDB 447498 D01 General RF Exposure Guidance v06

The 1-g and 10-g SAR test exclusion thresholds for 100 MHz to 6 GHz at test separation distances ≤ 50 mm are determined by:

$$[(\text{max. power of channel, including tune-up tolerance, mW})/(\text{min. test separation distance, mm})] \cdot$$

$$[v_f(\text{GHz})] \leq 3.0 \text{ for 1-g SAR and } \leq 7.5 \text{ for 10-g extremity SAR, where}$$

1. $f(\text{GHz})$ is the RF channel transmit frequency in GHz.
2. Power and distance are rounded to the nearest mW and mm before calculation.
3. The result is rounded to one decimal place for comparison.
4. 3.0 and 7.5 are referred to as the numeric thresholds in the step 2 below

The test exclusions are applicable only when the minimum test separation distance is ≤ 50 mm, and for transmission frequencies between 100 MHz and 6 GHz. When the minimum test separation distance is < 5 mm, a distance of 5 mm according to 4.1 f) is applied to determine SAR test exclusion.

4.2 RF Exposure Evaluation Result

RF Exposure Evaluation:

Frequency (MHz)	Turn-up Power		Evaluation Distance (mm)	SAR Exclusion Result	Extremity SAR Exclusion Limit (10g SAR)
	(dBm)	(mW)			
2402-2480	-5.00	0.3160	5	0.1595	7.5

Result: SAR evaluation is not necessary.

5 FCC §15.203 - Antenna Requirements

5.1 Applicable Standard

According to § 15.203, an intentional radiator shall be designed to ensure that no antenna other than that furnished by the responsible party shall be used with the device. The use of a permanently attached antenna or of an antenna that uses a unique coupling to the intentional radiator shall be considered sufficient to comply with the provisions of this section. The manufacturer may design the unit so that a broken antenna can be replaced by the user, but the user of a standard antenna jack or electrical connector is prohibited.

And according to FCC 47 CFR section 15.247 (b), if the transmitting antennas of directional gain greater than 6dBi are used, the power shall be reduced by the amount in dB that the directional gain of the antenna does not exceed 6dBi

5.2 Antenna List and Details

Antenna Type	Brand	Model	Antenna Gain	Result
Chip Antenna	PSA	RFANT3216120A1T	2.00 dBi	Compliance

The EUT has an Internal dedicated antennas arrangement, fulfill the requirement of this section.

6 FCC §15.207 - AC Line Conducted Emissions

6.1 Applicable Standard

According to FCC §15.207,

For an intentional radiator that is designed to be connected to the public utility (AC) power line, the radio frequency voltage that is conducted back onto the AC power line on any frequency or frequencies within the band 150 kHz to 30 MHz shall not exceed the limits in the following table, as measured using a 50 μ H/50 ohms line impedance stabilization network (LISN). Compliance with the provisions of this paragraph shall be based on the measurement of the radio frequency voltage between each power line and ground at the power terminal. The lower limit applies at the boundary between the frequencies ranges.

Frequency (MHz)	Conducted Limit (dBuV)	
	Quasi-Peak	Average
0.15-0.5	66 to 56 ^{Note 1}	56 to 46 ^{Note 2}
0.5-5	56	46
5-30	60	50

Note 1: Decreases with the logarithm of the frequency. Note 2: A linear average detector is required

6.2 EUT Setup and Test Procedure

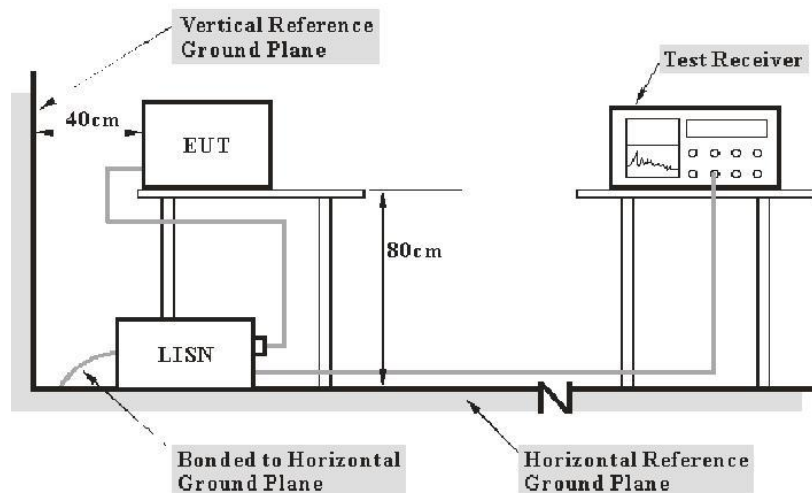

- Note: 1. Support units were connected to second LISN.
 2. Both of LISNs (AMN) 80 cm from EUT and at the least 80 cm from other units and other metal planes support units.

The setup of EUT is according with per ANSI C63.10-2013 measurement procedure. The specification used was with the FCC Part 15.207 limits

The EMI test receiver was set to investigate the spectrum from 150 kHz to 30 MHz. During the conducted emission test, the EMI test receiver was set with the following configurations

Frequency Range	Receiver RBW
150 kHz - 30 MHz	9 kHz

During the conducted emission test, the adapter was connected to the outlet of the LISN. Maximizing procedure was performed on the six (6) highest emissions of the EUT. All data was recorded in the Quasi-peak and average detection mode.

6.3 Test Equipment List and Details

Description	Manufacture	Model	Serial No.	Cal. Date.	Cal. Due.
AC Line Conduction Room (CON-01)					
Two-Line V-Network	Rohde & Schwarz	ENV216	100010	2019/09/02	2020/09/01
Pulse Limiter	SCHWARZBECK	VSTD 9561-F	00432	2019/08/28	2020/08/27
EMI Test Receiver	Rohde & Schwarz	ESR3	102448	2019/06/27	2020/06/23
RF Cable	EMCI	EMCCFD300-BM- BM-8000	180526	2019/08/08	2020/08/07
Software	Audix	e3 v9	E3LK-03	N.C.R	N.C.R

***Statement of Traceability:** The testing equipment's listed above have finished the calibration by Electronics Testing Center, Taiwan (ETC) or other laboratories which were accredited by TAF or equivalent organizations. The calibration result could be traceable to the International System of Units (SI).

6.4 Test Result

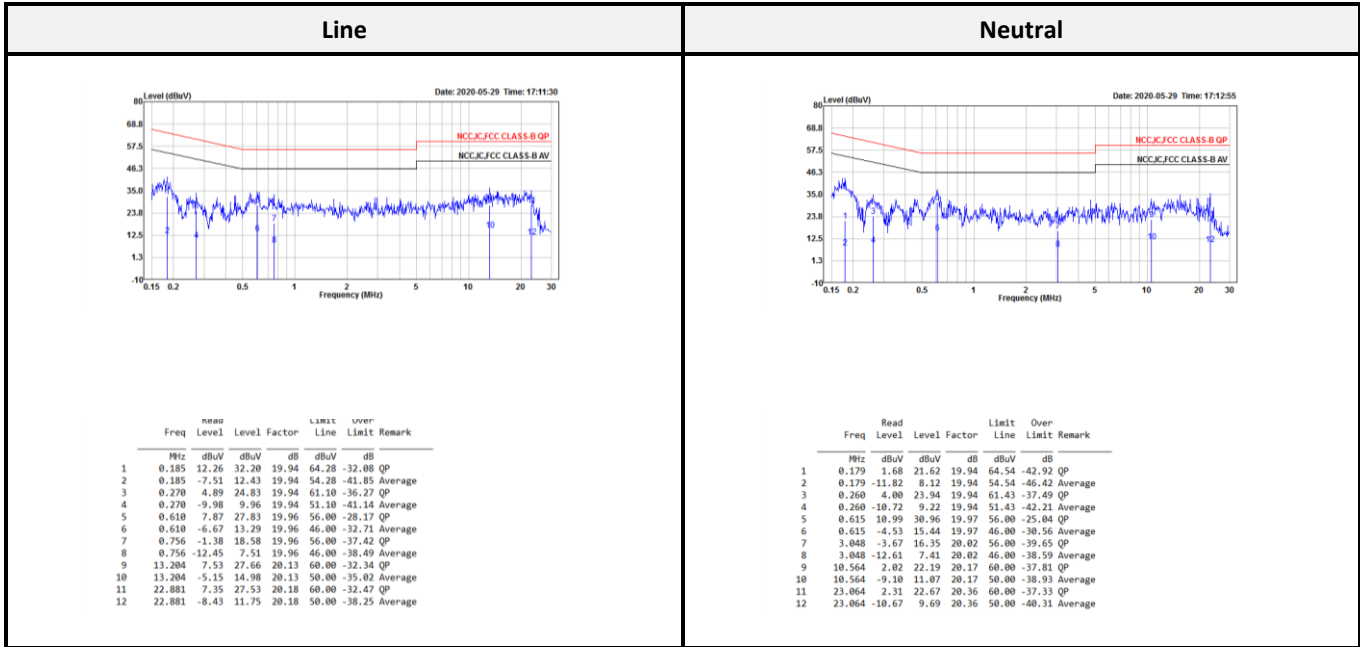

Note1: Transmit mode

Note2:

Level = Read Level + Factor

Over Limit (Margin) = Level – Limit Line

Factor = (LISN, ISN, PLC or current probe) Factor + Cable Loss + Attenuator

7 FCC §15.209, §15.205, §15.247(d) – Spurious Emissions

7.1 Applicable Standard

As per FCC §15.35(d): Unless otherwise specified, on any frequency or frequencies above 1000 MHz, the radiated emission limits are based on the use of measurement instrumentation employing an average detector function. Unless otherwise specified, measurements above 1000 MHz shall be performed using a minimum resolution bandwidth of 1MHz.

As Per FCC §15.205(a) except as show in paragraph (d) of this section, only spurious emissions are permitted in any of the frequency bands listed below:

MHz	MHz	MHz	GHz
0.090-0.110	13.36-13.41	399.9-410	4.5-5.15
0.495-0.505	16.42-16.423	608-614	5.35-5.46
2.1735-2.1905	16.69475-16.69525	960-1240	7.25-7.75
4.125-4.128	25.5-25.67	1300-1427	8.025-8.5
4.17725-4.17775	37.5-38.25	1435-1626.5	9.0-9.2
4.20725-4.20775	73-74.6	1645.5-1646.5	9.3-9.5
6.215-6.218	74.8-75.2	1660-1710	10.6-12.7
6.26775-6.26825	108-121.94	1718.8-1722.2	13.25-13.4
6.31175-6.31225	123-138	2200-2300	14.47-14.5
8.291-8.294	149.9-150.05	2310-2390	15.35-16.2
8.362-8.366	156.52475-156.52525	2483.5-2500	17.7-21.4
8.37625-8.38675	156.7-156.9	2690-2900	22.01-23.12
8.41425-8.41475	162.0125-167.17	3260-3267	23.6-24.0
12.29-12.293	167.72-173.2	3332-3339	31.2-31.8
12.51975-12.52025	240-285	3345.8-3358	36.43-36.5
12.57675-12.57725	322-335.4	3600-4400	Above 38.6

As per FCC §15.209(a): Except as provided elsewhere in this Subpart, the emissions from an intentional radiator shall not exceed the field strength levels specified in the following table:

Frequency (MHz)	Field Strength (micro volts/meter)	Measurement Distance (meters)
0.009 - 0.490	2400/F(kHz)	300
0.490 - 1.705	24000/F(kHz)	30
1.705 - 30.0	30	30
30 - 88	100**	3
88 - 216	150**	3
216 - 960	200**	3
Above 960	500	3

** Except as provided in paragraph (g), fundamental emissions from intentional radiators operating under this Section shall not be located in the frequency bands 54-72 MHz, 76-88 MHz, 174-216 MHz or 470-806MHz. However, operation within these frequency bands is permitted under other sections of this Part, e.g., Sections 15.231 and 15.241.

As per FCC §15.247 (d) In any 100 kHz bandwidth outside the frequency band in which the spread spectrum or digitally modulated intentional radiator is operating, the radio frequency power that is produced by the intentional radiator shall be at least 20 dB below that in the 100 kHz bandwidth within the band that contains the highest level of the desired power, based on either an RF conducted or a radiated measurement, provided the transmitter demonstrates compliance with the peak conducted power limits. If the transmitter complies with the conducted power limits based on the use of RMS averaging over a time interval, as permitted under paragraph (b)(3) of this section, the attenuation required under this paragraph shall be 30 dB instead of 20dB. Attenuation below the general limits specified in §15.209(a) is not required. In addition, radiated emissions which fall in the restricted bands, as defined in §15.205(a), must also comply with the radiated emission limits specified in §15.209(a) (see §15.205(c)).

7.2 EUT Setup and Test Procedure

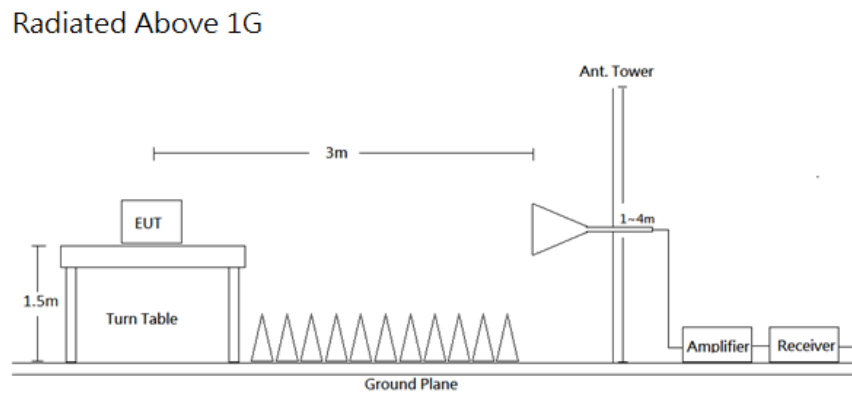
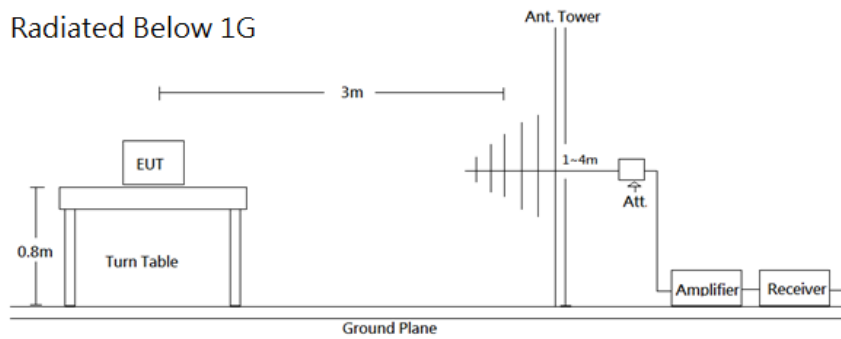

Radiated emission tests were performed in the 3 meters chamber test site, using the setup accordance with the ANSI C63.10-2013. The specification used was the FCC Part 15.209 and FCC 15.247 Limits.

The system was investigated from 30 MHz to 26.5 GHz. During the radiated emission test, the EMI test receiver was set with the following configurations measurement method 6.3 in ANSI C63.10.

Frequency Range	RBW	VBW	Duty cycle	Measurement method
30-1000 MHz	120 kHz	/	-	QP
Above 1 GHz	1 MHz	3 MHz	-	PK
	1 MHz	10 Hz	>98%	Ave
	1 MHz	1/T	<98%	Ave

Maximizing procedure was performed on the highest emissions to ensure that the EUT complied with all installation combinations. All data was recorded in the Quasi-peak detector mode from 30 MHz to 1 GHz and PK and average detector modes for frequencies above 1 GHz.

7.3 Test Equipment List and Details

Description	Manufacture	Model	Serial No.	Cal. Date.	Cal. Due.
Radiation 3M Room (966A)					
Active Loop	EMCO	6502	0001-3322	2020/03/16	2021/03/15
Bilog Antenna/6 dB Attenuator	SUNOL SCIENCES & EMEC /EMCI	JB3/N-6-06	A111513/AT-N0668	2020/03/19	2021/03/18
Horn Antenna	ETS-Lindgren	3115	00109141	2019/07/05	2020/07/04
Horn Antenna	ETS-Lindgren	3160-09	00123852	2019/07/11	2020/07/10
Preamplifier	A.H. Systems	PAM-0118	470	2020/03/16	2021/03/15
Preamplifier	A.H. Systems	PAM-1840VH	174	2020/03/25	2021/03/24
Signal Analyzer 40GHZ	Rohde & Schwarz	FSV40-N	102248	2019/09/11	2020/09/10
Microflex Cable (1m)	EMCI	EMC106-SM-SM-2000	180515	2019/08/07	2020/08/06
Microflex Cable (2m)	MTJ	H0919	00000-MT28A-100	2019/08/07	2020/08/06
Microflex Cable (8m)	UTIFLEX	UFA210A-1-3149-300300	MFR 64639 232490-001	2019/08/07	2020/08/06
Turn Table	Chaintek	T-200-S-1	003501	N.C.R	N.C.R
Antenna Tower	Chaintek	MBD-400-1	003504	N.C.R	N.C.R
Controller	Chaintek	3000-1	003507	N.C.R	N.C.R
Software	Audix	e3 v9	E3LK-01	N.C.R	N.C.R
Conducted Room(TH-02)					
Signal Analyzer 40GHZ	Rohde & Schwarz	FSV40-N	102248	2019/09/11	2020/09/10
RF Cable	MTJ	MT40S	MT40S-001	Each Use	/

***Statement of Traceability:** The testing equipment's listed above have finished the calibration by Electronics Testing Center, Taiwan (ETC) or other laboratories which were accredited by TAF or equivalent organizations. The calibration result could be traceable to the International System of Units (SI).

7.4 Test Result

Transmitting mode (Pre-scan with three orthogonal axis, and worse case as X axis)

Below 1G (30 MHz-1 GHz) test the output power worst mode with adapter

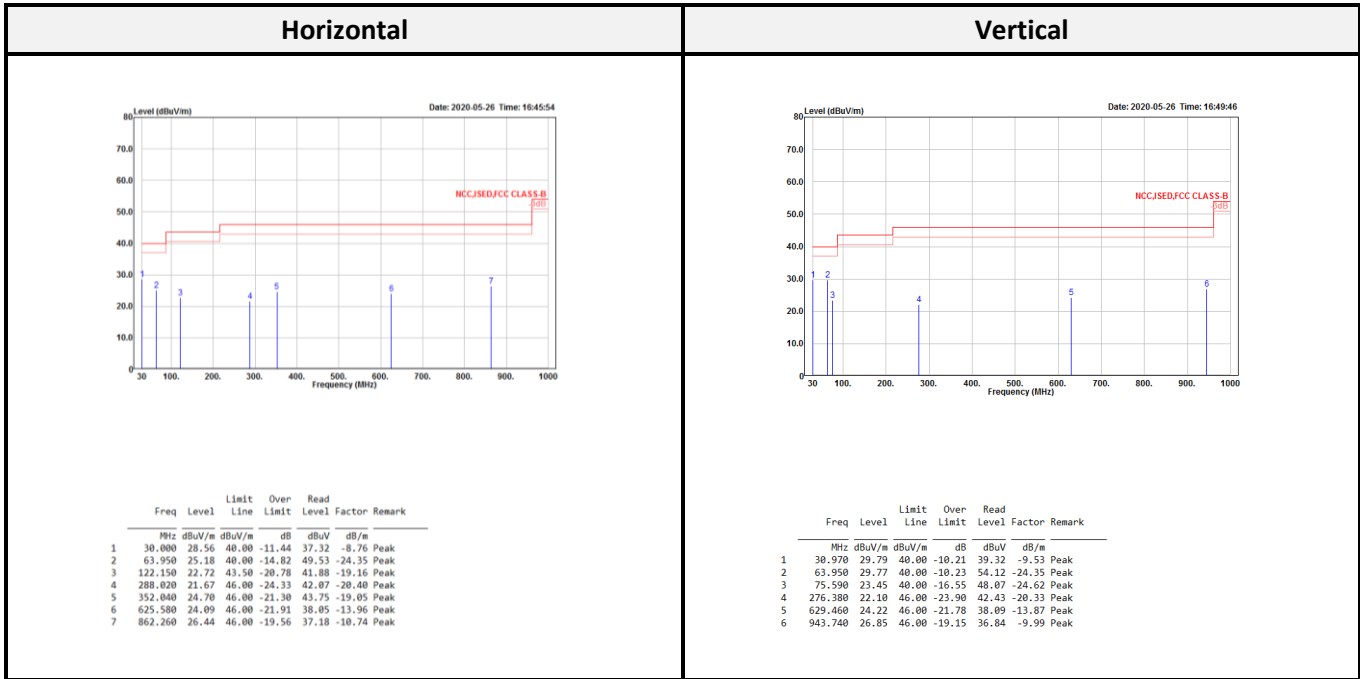

Note1: Transmit mode

Note2:

Level = Read Level + Factor

Over Limit = Level – Limit

Correct Factor = Antenna Factor + Cable Loss – Amplifier Gain

Spurious emissions more than 20 dB below the limit were not reported

Above 1G (1 GHz-26.5 GHz)

Low CH Horizontal							Low CH Vertical						
Freq	Level	Limit Line	Over Limit	Read Level	Factor	Remark	Freq	Level	Limit Line	Over Limit	Read Level	Factor	Remark
MHz	dBuV/m	dBuV/m	dB	dBuV	dB/m		MHz	dBuV/m	dBuV/m	dB	dBuV	dB/m	
2389.200	35.98	54.00	-18.02	45.69	-9.71	Average	2382.400	34.83	54.00	-19.17	44.57	-9.74	Average
2389.200	46.67	74.00	-27.33	56.38	-9.71	Peak	2382.400	45.79	74.00	-28.21	55.53	-9.74	Peak
2402.400	82.39			92.07	-9.68	Average	2402.400	79.56			89.24	-9.68	Average
2402.400	83.38			93.06	-9.68	Peak	2402.400	80.58			90.26	-9.68	Peak
4806.000	45.45	54.00	-8.55	48.57	-3.12	Average	4806.000	45.01	54.00	-8.99	48.13	-3.12	Average
4806.000	48.94	74.00	-25.06	52.06	-3.12	Peak	4806.000	48.77	74.00	-25.23	51.89	-3.12	Peak
7206.000	49.47	54.00	-4.53	45.79	3.68	Average	7206.000	49.23	54.00	-4.77	45.55	3.68	Average
7206.000	58.16	74.00	-15.84	54.48	3.68	Peak	7206.000	57.63	74.00	-16.37	53.95	3.68	Peak

Middle CH Horizontal							Middle CH Vertical						
Freq	Level	Limit Line	Over Limit	Read Level	Factor	Remark	Freq	Level	Limit Line	Over Limit	Read Level	Factor	Remark
MHz	dBuV/m	dBuV/m	dB	dBuV	dB/m		MHz	dBuV/m	dBuV/m	dB	dBuV	dB/m	
2335.410	32.41	54.00	-21.59	42.29	-9.88	Average	2343.880	31.99	54.00	-22.01	41.84	-9.85	Average
2335.410	45.05	74.00	-28.95	54.93	-9.88	Peak	2343.880	44.55	74.00	-29.45	54.40	-9.85	Peak
2440.438	80.05			89.61	-9.56	Average	2440.438	77.42			86.98	-9.56	Average
2440.438	81.14			90.70	-9.56	Peak	2440.438	78.53			88.09	-9.56	Peak
2485.208	32.73	54.00	-21.27	42.15	-9.42	Average	2537.722	33.18	54.00	-20.82	42.38	-9.20	Average
2485.208	46.06	74.00	-27.94	55.48	-9.42	Peak	2537.722	45.79	74.00	-28.21	54.99	-9.20	Peak
4882.000	46.69	54.00	-7.31	49.54	-2.85	Average	4882.000	44.77	54.00	-9.23	47.62	-2.85	Average
4882.000	49.85	74.00	-24.15	52.70	-2.85	Peak	4882.000	48.03	74.00	-25.97	50.88	-2.85	Peak
7320.000	43.50	54.00	-10.50	39.50	4.00	Average	7320.000	45.30	54.00	-8.70	41.30	4.00	Average
7320.000	52.21	74.00	-21.79	48.21	4.00	Peak	7320.000	54.10	74.00	-19.90	50.10	4.00	Peak

High CH Horizontal							High CH Vertical						
Freq	Level	Limit Line	Over Limit	Read Level	Factor	Remark	Freq	Level	Limit Line	Over Limit	Read Level	Factor	Remark
MHz	dBuV/m	dBuV/m	dB	dBuV	dB/m		MHz	dBuV/m	dBuV/m	dB	dBuV	dB/m	
2479.840	76.48			85.91	-9.43	Average	2479.840	75.01			84.44	-9.43	Average
2479.840	77.69			87.12	-9.43	Peak	2479.840	76.20			85.63	-9.43	Peak
2483.694	38.44	54.00	-15.56	47.86	-9.42	Average	2483.776	37.27	54.00	-16.73	46.69	-9.42	Average
2483.694	48.52	74.00	-25.48	57.94	-9.42	Peak	2483.776	47.83	74.00	-26.17	57.25	-9.42	Peak
4958.000	48.98	54.00	-5.02	51.52	-2.54	Average	4958.000	45.77	54.00	-8.23	48.31	-2.54	Average
4958.000	51.22	74.00	-22.78	53.76	-2.54	Peak	4958.000	49.04	74.00	-24.96	51.58	-2.54	Peak
7440.000	40.19	54.00	-13.81	35.94	4.25	Average	7440.000	41.00	54.00	-13.00	36.75	4.25	Average
7440.000	50.16	74.00	-23.84	45.91	4.25	Peak	7440.000	50.35	74.00	-23.65	46.10	4.25	Peak

Above 1G (1 GHz-26.5 GHz): The worst mode: BLE mode Low CH

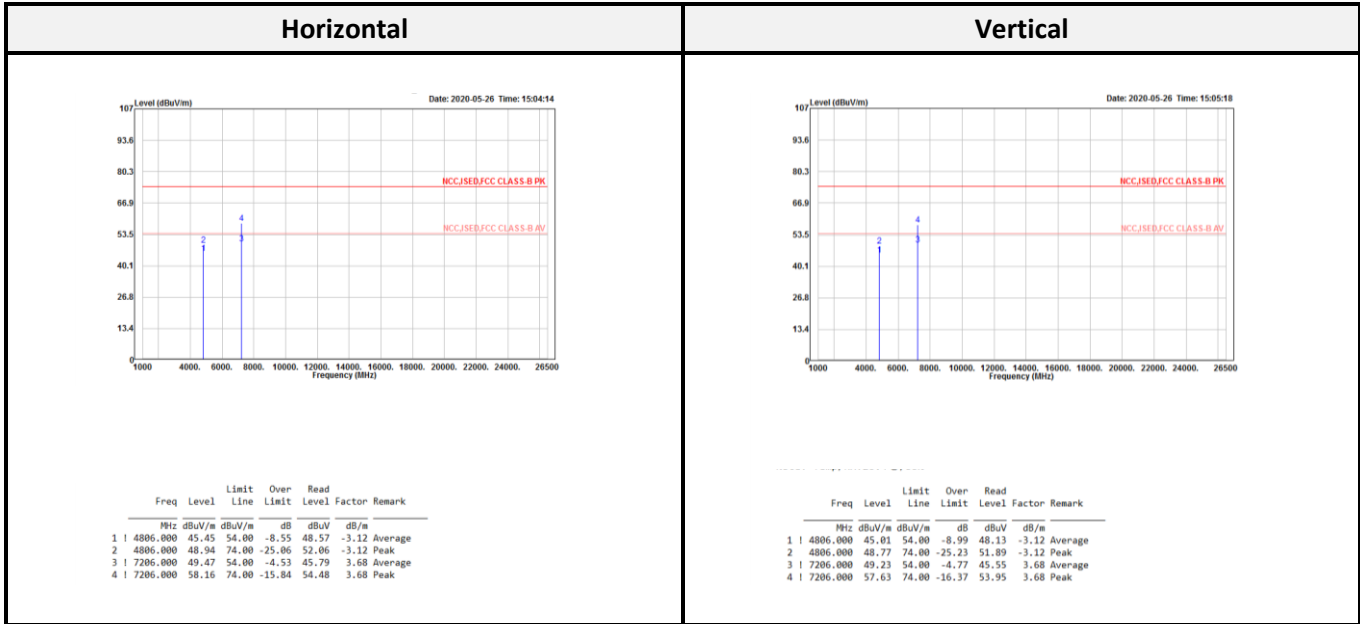

Note1: Transmit mode

Note2:

Level = Read Level + Factor

Over Limit = Level – Limit

Correct Factor = Antenna Factor + Cable Loss – Amplifier Gain

Spurious emissions more than 20 dB below the limit were not reported

Conducted Spurious Emissions:

Configuration	Channel	Frequency (MHz)	Delta Peak to Band Emission (dBc)	Limit (dBc)	Result
BLE mode	Low	2402	32.99	≥ 20	Compliance
	Mid	2440	33.49	≥ 20	Compliance
	High	2480	31.81	≥ 20	Compliance

BLE Mode

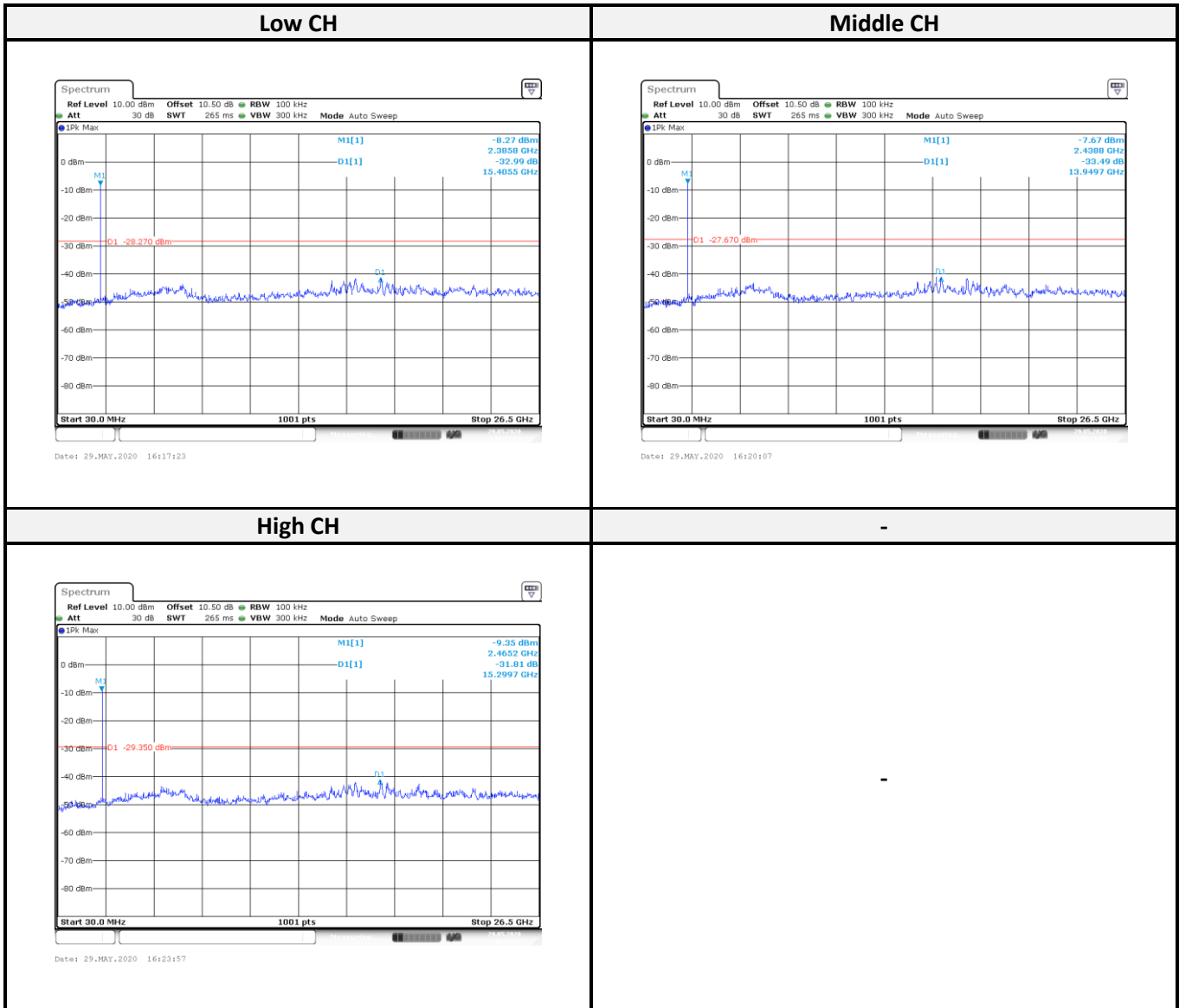

8 FCC §15.247(a)(2) – 6 dB Emission Bandwidth

8.1 Applicable Standard

According to FCC §15.247(a) (2),

Systems using digital modulation techniques may operate in the 902–928 MHz, 2400–2483.5 MHz, and 5725–5850 MHz bands. The minimum 6 dB bandwidth shall be at least 500 kHz.

8.2 Test Procedure

According to ANSI C63.10-2013, the steps for the first option are as follows:

- (1) Set RBW = 100 kHz. (2) Set the VBW \geq [3 \times RBW]. (3) Detector = peak. (4) Trace mode = max hold.
- (5) Sweep = auto couple. (6) Allow the trace to stabilize. (7) Measure the maximum width of the emission that is constrained by the frequencies associated with the two outermost amplitude points (upper and lower frequencies) that are attenuated by 6 dB relative to the maximum level measured in the fundamental emission.

8.3 Test Equipment List and Details

Description	Manufacture	Model	Serial No.	Cal. Date.	Cal. Due.
Conducted Room(TH-02)					
Signal Analyzer 40GHZ	Rohde & Schwarz	FSV40-N	102248	2019/09/11	2020/09/10
RF Cable	MTJ	MT40S	MT40S-001	Each Use	/

***Statement of Traceability:** The testing equipment's listed above have finished the calibration by Electronics Testing Center, Taiwan (ETC) or other laboratories which were accredited by TAF or equivalent organizations. The calibration result could be traceable to the International System of Units (SI).

8.4 Test Results

Channel	Frequency (MHz)	6 dB BW (MHz)	6dB Limit (MHz)	Result
BLE mode				
Low	2402	0.74	> 0.5	Compliance
Middle	2440	0.75	> 0.5	Compliance
High	2480	0.75	> 0.5	Compliance

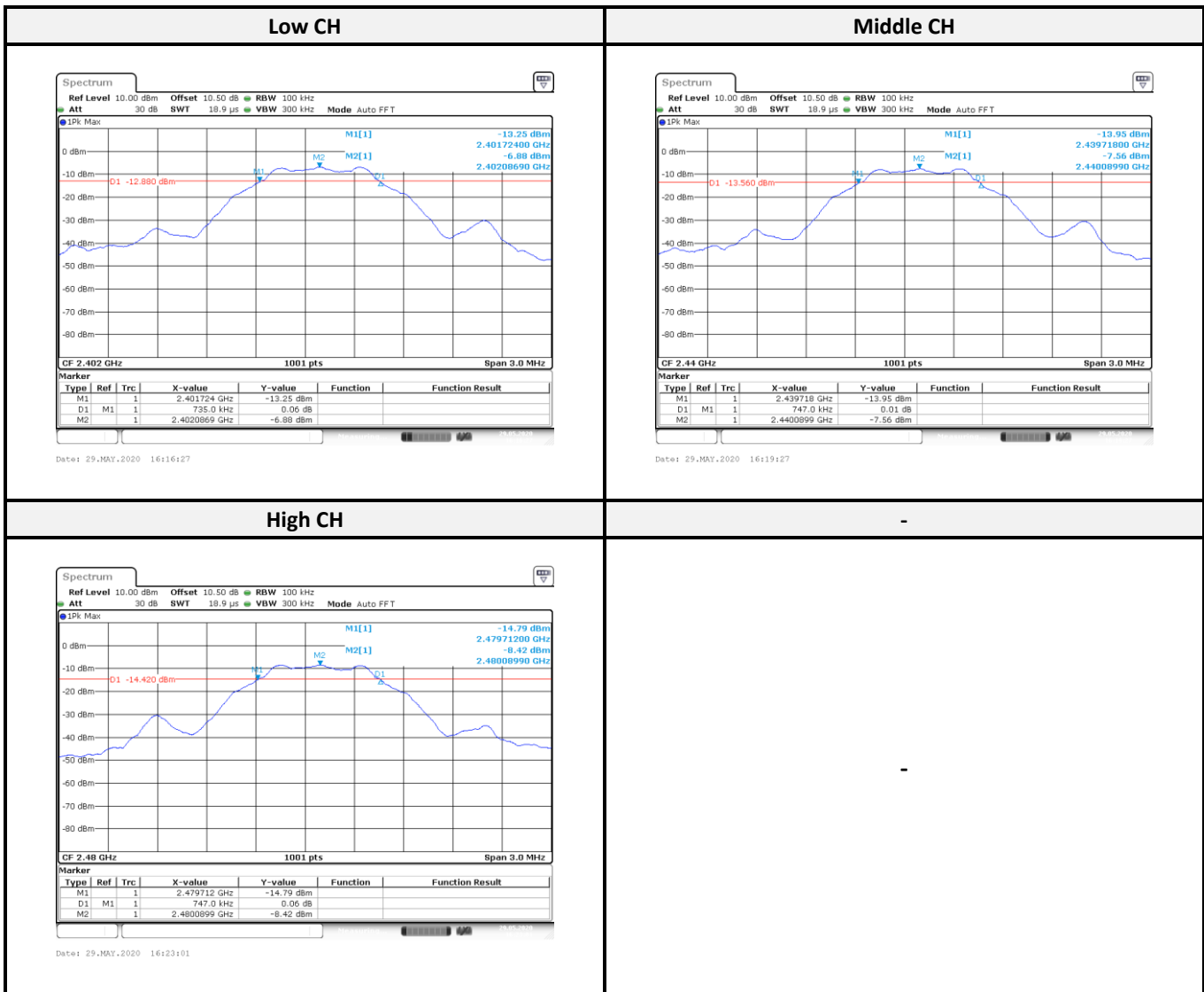

9 FCC §15.247(b) (3) – Maximum Output Power

9.1 Applicable Standard

According to FCC §15.247(b) (3),

Systems using digital modulation in the 902-928 MHz, 2400-2483.5 MHz, and 5725-5850 MHz bands: 1 Watt.

As an alternative to a peak power measurement, compliance with the one Watt limit can be based on a measurement of the maximum conducted output power. Maximum Conducted Output Power is defined as the total transmit power delivered to all antennas and antenna elements averaged across all symbols in the signaling alphabet when the transmitter is operating at its maximum power control level. Power must be summed across all antennas and antenna elements. The average must not include any time intervals during which the transmitter is off or is transmitting at a reduced power level. If multiple modes of operation are possible (e.g., alternative modulation methods), the maximum conducted output power is the highest total transmit power occurring in any mode.

9.2 Test Procedure

- (1) Place the EUT on a bench and set it in transmitting mode.
- (2) Remove the antenna from the EUT and then connect a low loss RF cable from the antenna port to measuring equipment.
- (3). Add a correction factor to the display.

9.3 Test Equipment List and Details

Description	Manufacture	Model	Serial No.	Cal. Date.	Cal. Due.
Conducted Room(TH-02)					
Signal Analyzer 40GHZ	Rohde & Schwarz	FSV40-N	102248	2019/09/11	2020/09/10
RF Cable	MTJ	MT40S	MT40S-001	Each Use	/

**Statement of Traceability: The testing equipment's listed above have finished the calibration by Electronics Testing Center, Taiwan (ETC) or other laboratories which were accredited by TAF or equivalent organizations. The calibration result could be traceable to the International System of Units (SI).*

9.4 Test Results

Channel	Frequency (MHz)	Maximum Peak Output Power (dBm)	Maximum Peak Output Power (W)	Limit (dBm)	Result
BLE mode:					
Low	2402	-5.06	0.0003	30	Compliance
Middle	2440	-5.47	0.0003	30	Compliance
High	2480	-5.75	0.0003	30	Compliance

10 FCC §15.247(d) – 100 kHz Bandwidth of Frequency Band Edge

10.1 Applicable Standard

According to FCC §15.247(d),

In any 100 kHz bandwidth outside the frequency band in which the spread spectrum or digitally modulated intentional radiator is operating, the radio frequency power that is produced by the intentional radiator shall be at least 20 dB below that in the 100 kHz bandwidth within the band that contains the highest level of the desired power, based on either an RF conducted or a radiated measurement, provided the transmitter demonstrates compliance with the peak conducted power limits.

If the transmitter complies with the conducted power limits based on the use of RMS averaging over a time interval, as permitted under paragraph (b)(3) of this section, the attenuation required under this paragraph shall be 30 dB instead of 20 dB.

Attenuation below the general limits specified in §15.209(a) is not required. In addition, radiated emissions which fall in the restricted bands, as defined in §15.205(a), must also comply with the radiated emission limits specified in §15.209(a) (see §15.205(c)).

10.2 Test Procedure

- (1) Check the calibration of the measuring instrument using either an internal calibrator or a known signal from an external generator.
- (2) Position the EUT without connection to measurement instrument. Turn on the EUT and connect its antenna terminal to measurement instrument via a low loss cable. Then set it to any one measured frequency within its operating range, and make sure the instrument is operated in its linear range.
- (3) Set RBW to 100 kHz and VBW of spectrum analyzer to 300 kHz with a convenient frequency span including 100 kHz bandwidth from band edge.
- (4) Measure the highest amplitude appearing on spectral display and set it as a reference level. Plot the graph with marking the highest point and edge frequency.

10.3 Test Equipment List and Details

Description	Manufacture	Model	Serial No.	Cal. Date.	Cal. Due.
Conducted Room(TH-02)					
Signal Analyzer 40GHZ	Rohde & Schwarz	FSV40-N	102248	2019/09/11	2020/09/10
RF Cable	MTJ	MT40S	MT40S-001	Each Use	/

***Statement of Traceability:** The testing equipment's listed above have finished the calibration by Electronics Testing Center, Taiwan (ETC) or other laboratories which were accredited by TAF or equivalent organizations. The calibration result could be traceable to the International System of Units (SI).

10.4 Test Results

Channel	Frequency (MHz)	Delta Peak to Band Emission (dBc)	Limit (dBc)	Result
BLE mode				
Low	2402	37.38	≥ 20	Compliance
High	2480	39.12	≥ 20	Compliance

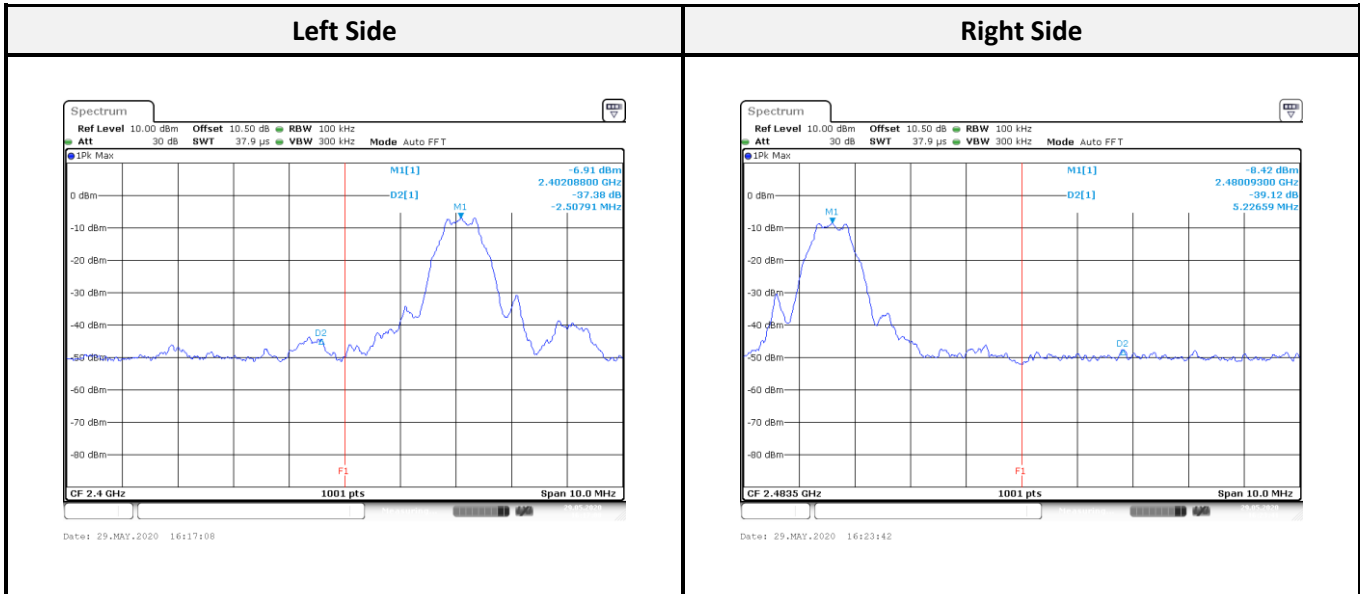

11 FCC §15.247(e) – Power Spectral Density

11.1 Applicable Standard

According to FCC §15.247(e),

For digitally modulated systems, the power spectral density conducted from the intentional radiator to the antenna shall not be greater than 8 dBm in any 3 kHz band during any time interval of continuous transmission. This power spectral density shall be determined in accordance with the provisions of paragraph (b) of this section. The same method of determining the conducted output power shall be used to determine the power spectral density.

11.2 Test Procedure

According to ANSI C63.10-2013,

- (1) Set analyzer center frequency to DTS channel center frequency.
- (2) Set the span to 1.5 times the DTS bandwidth. (3) Set the RBW to $3 \text{ kHz} \leq \text{RBW} \leq 100 \text{ kHz}$.
- (4) Set the VBW $\geq [3 \times \text{RBW}]$. (5) Detector = peak. (6) Sweep time = auto couple.
- (7) Trace mode = max hold. (8) Allow trace to fully stabilize.
- (9) Use the peak marker function to determine the maximum amplitude level within the RBW.
- (10) If measured value exceeds requirement, then reduce RBW (but no less than 3 kHz) and repeat.

11.3 Test Equipment List and Details

Description	Manufacture	Model	Serial No.	Cal. Date.	Cal. Due.
Conducted Room(TH-02)					
Signal Analyzer 40GHZ	Rohde & Schwarz	FSV40-N	102248	2019/09/11	2020/09/10
RF Cable	MTJ	MT40S	MT40S-001	Each Use	/

***Statement of Traceability:** The testing equipment's listed above have finished the calibration by Electronics Testing Center, Taiwan (ETC) or other laboratories which were accredited by TAF or equivalent organizations. The calibration result could be traceable to the International System of Units (SI).

11.4 Test Results

Channel	Frequency (MHz)	PSD (dBm/3 kHz)	Limit (dBm/3 kHz)	Result
BLE mode				
Low	2402	-20.42	8	Compliance
Middle	2440	-21.05	8	Compliance
High	2480	-21.97	8	Compliance

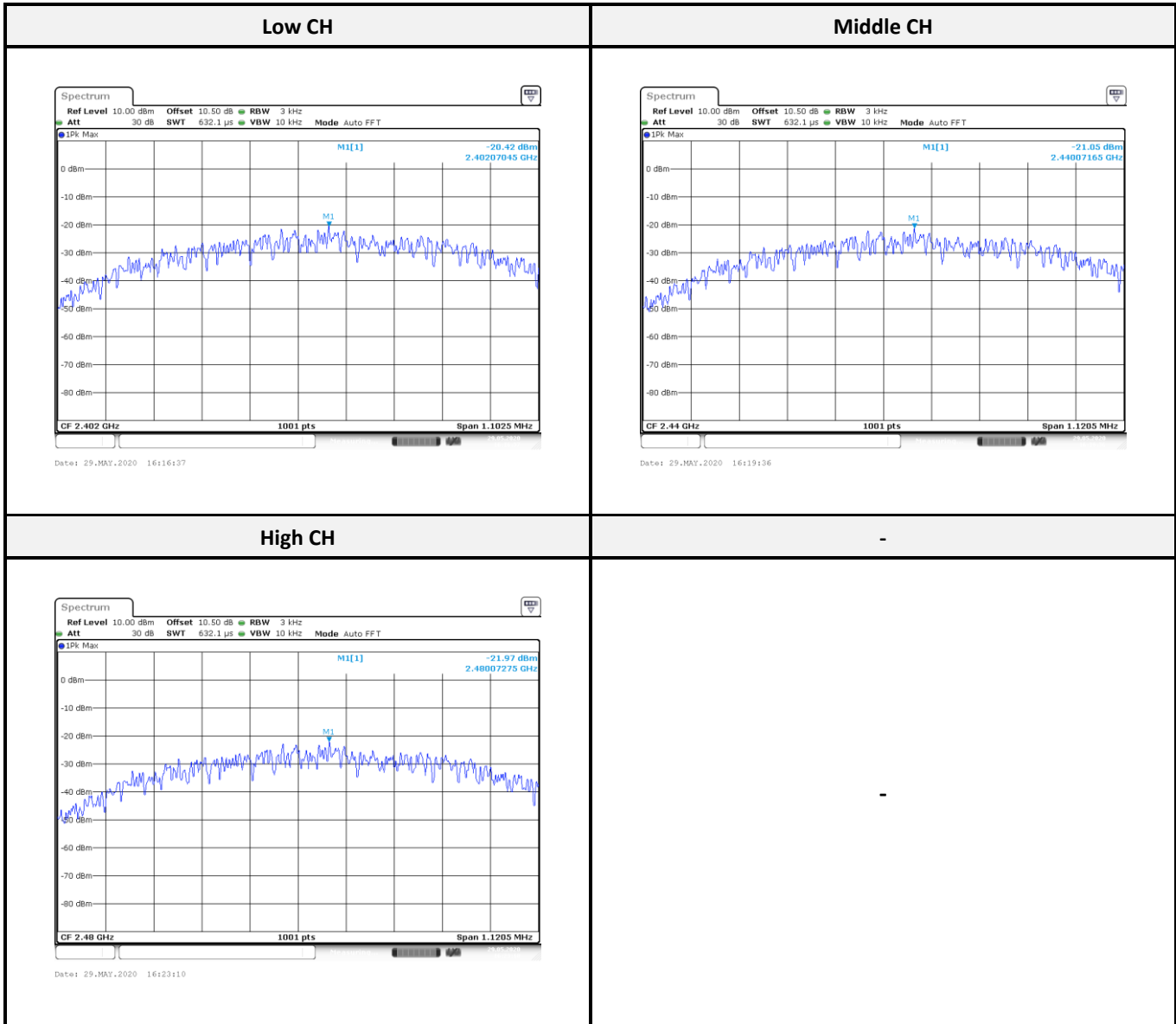

----- END OF REPORT -----