

TEST REPORT

Report No.: BCTC2105000778-3E

Applicant: Shenzhen Gosinggo Electronics Co., Ltd.

Product Name: Soundbar

Model/Type Ref.: GS-SB60

Tested Date: 2021-06-01 to 2021-07-14

Issued Date: 2021-07-14

Shenzhen BCTC Testing Co., Ltd.



FCC ID: 2AOCR-GS-SB60

Product Name: Soundbar
Trademark: N/A
Model/Type Ref.: GS-SB60
GS-SB54, GS-SB55, GS-SB56, GS-SB57, GS-SB71
Prepared For: Shenzhen Gosingo Electronics Co., Ltd.
Address: R302, Bldg B, Tianrun Smart Innovation Industrial Park, No.23, Jiuwei 1st Rd, Hangcheng Str, Baoan District, Shenzhen City, China
Manufacturer: Shenzhen Gosingo Electronics Co., Ltd.
Address: R302, Bldg B, Tianrun Smart Innovation Industrial Park, No.23, Jiuwei 1st Rd, Hangcheng Str, Baoan District, Shenzhen City, China
Prepared By: Shenzhen BCTC Testing Co., Ltd.
Address: 1-2/F., Building B, Pengzhou Industrial Park, No.158, Fuyuan 1st Road, Tangwei, Fuhai Subdistrict, Bao'an District, Shenzhen, Guangdong, China
Sample Received Date: 2021-05-27
Sample tested Date: 2021-06-01 to 2021-07-14
Issue Date: 2021-07-14
Report No.: BCTC2105000778-3E
Test Standards: FCC Part15.249
ANSI C63.10-2013
Test Results: PASS

Tested by:

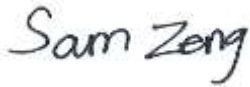

Sam zeng/Project Handler

Approved by:



Zero Zhou/Reviewer

The test report is effective only with both signature and specialized stamp. This result(s) shown in this report refer only to the sample(s) tested. Without written approval of Shenzhen BCTC Testing Co., Ltd, this report can't be reproduced except in full. The tested sample(s) and the sample information are provided by the client.

TABLE OF CONTENT

Test Report Declaration	Page
1. VERSION	5
2. TEST SUMMARY	6
3. MEASUREMENT UNCERTAINTY	7
4. PRODUCT INFORMATION AND TEST SETUP	8
4.1 Product Information	8
4.2 Test Setup Configuration	9
4.3 Support Equipment	9
4.4 Channel List	9
4.5 Test Mode	9
5. TEST FACILITY AND TEST INSTRUMENT USED	11
5.1 Test Facility	11
5.2 Test Instrument Used	11
5. CONDUCTED EMISSIONS	13
5.1 Block Diagram Of Test Setup	13
5.2 Limit	13
5.3 Test procedure	13
5.4 EUT operating Conditions	14
5.5 Test Result	15
6. RADIATED EMISSIONS	17
6.1 Block Diagram Of Test Setup	17
6.2 Limit	18
6.3 Test procedure	19
6.4 EUT operating Conditions	21
6.5 Test Result	22
6.6 Field Strength Calculation	27
7. 100 KHZ BANDWIDTH OF FREQUENCY BAND EDGE	30
7.1 Block Diagram Of Test Setup	30
7.2 Applicable Standard	30
7.3 Test procedure	30
7.4 EUT operating Conditions	31
7.5 Test Result	31
8. 20 DB BANDWIDTH	37
8.1 Block Diagram Of Test Setup	37
8.2 Limit	37
8.3 Test procedure	37
8.4 EUT OPERATION CONDITIONS	37
8.5 Test Result	38
9. ANTENNA REQUIREMENT	40
9.1 Limit	40

9.2 Test Result	40
10. EUT PHOTOGRAPHS	41
11. EUT TEST SETUP PHOTOGRAPHS	42

(Note: N/A means not applicable)

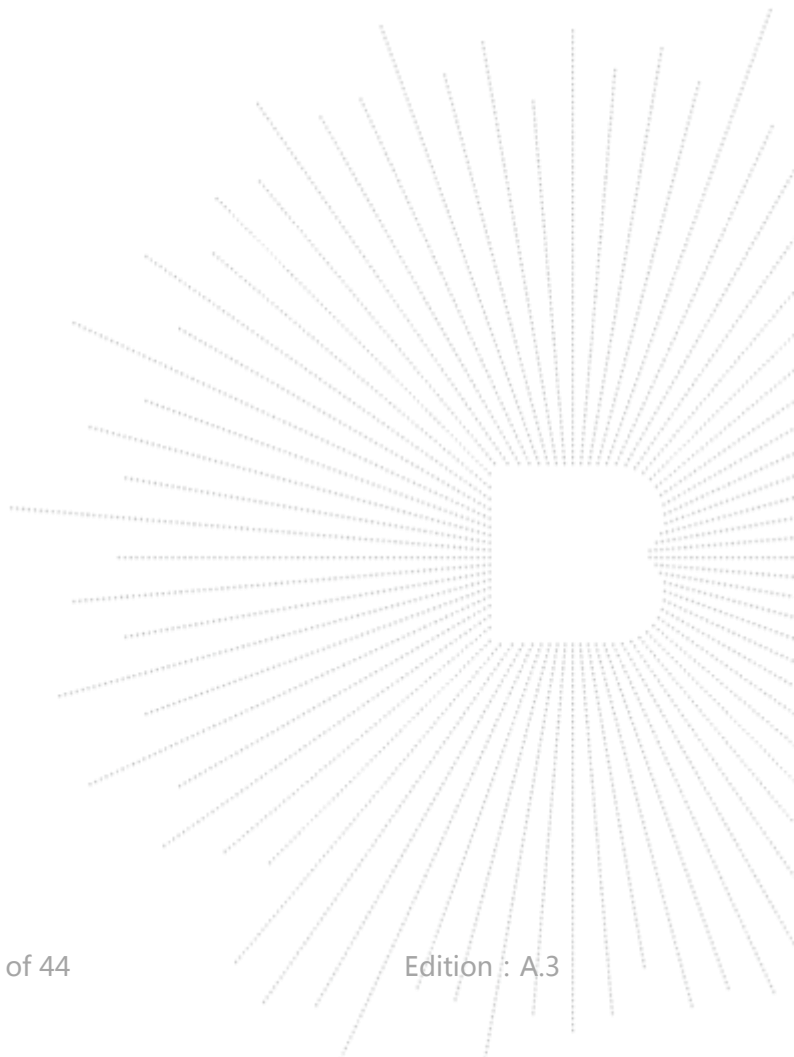

1. VERSION

Report No.	Issue Date	Description	Approved
BCTC2105000778-3E	2021-07-14	Original	Valid

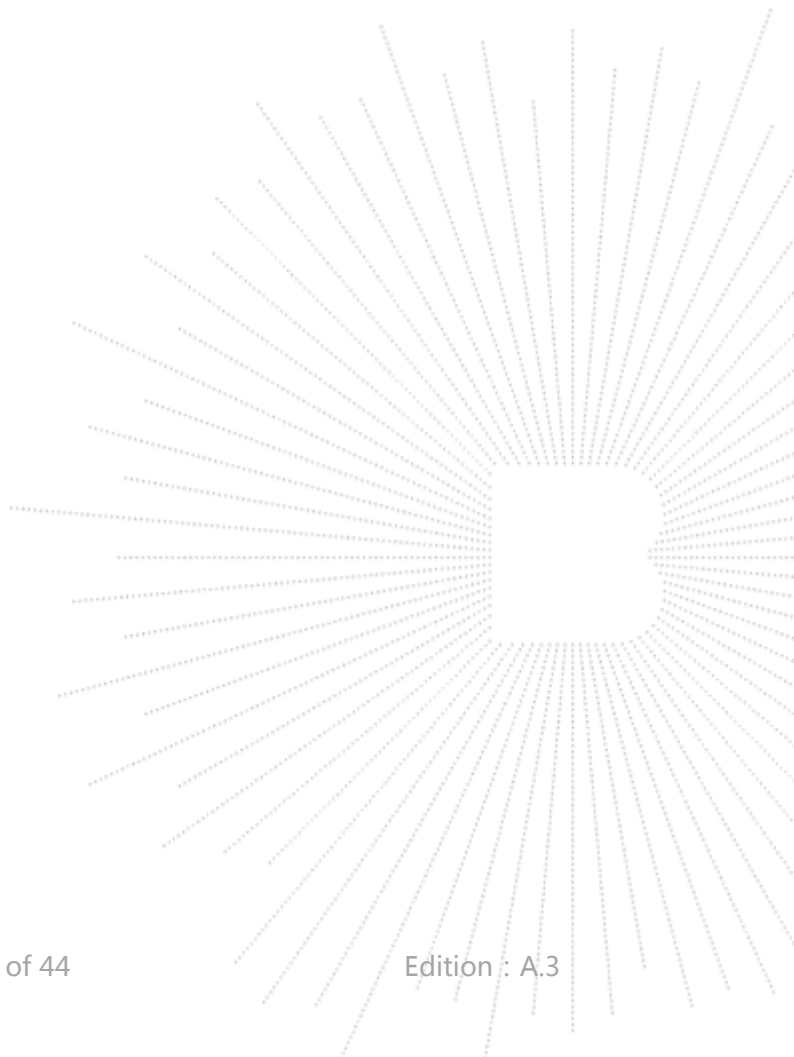

2. TEST SUMMARY

The Product has been tested according to the following specifications:

No.	Test Parameter	Clause No	Results
1	Conducted Emission	15.207	PASS
2	20dB Bandwidth	15.215	PASS
3	Fundamental & Radiated Spurious Emission Measurement	15.249	PASS
4	Band Edge Emission	15.205	PASS
5	Antenna Requirement	15.203	PASS

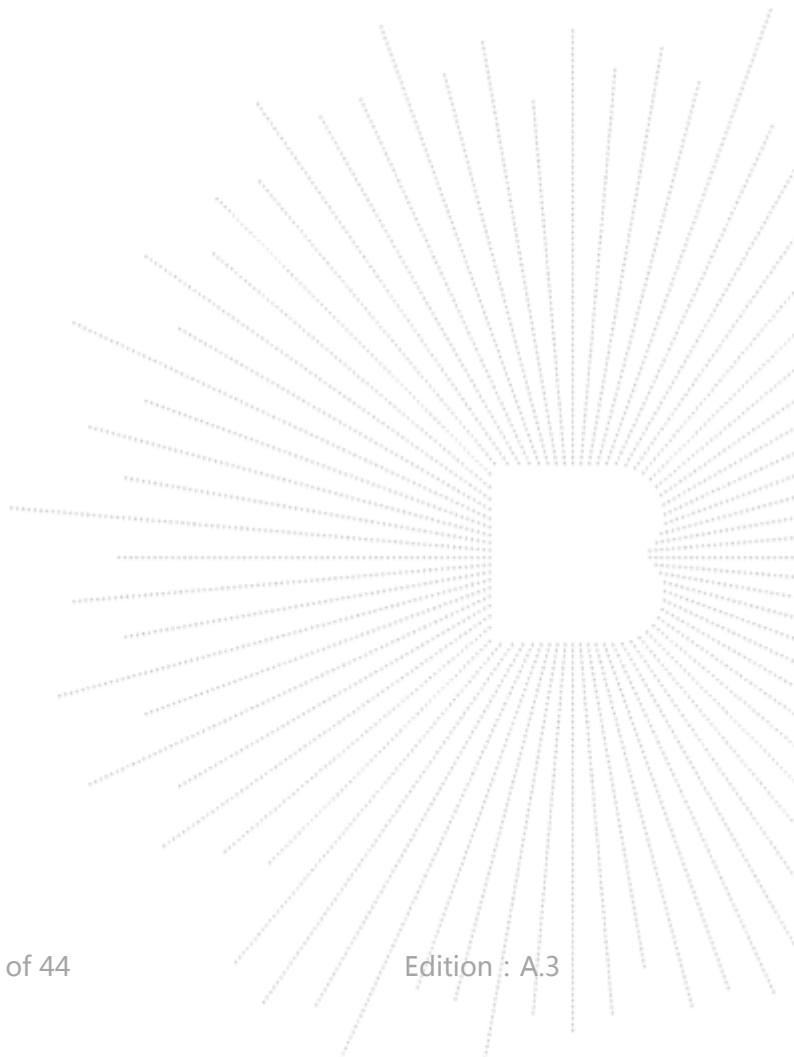

3. MEASUREMENT UNCERTAINTY

Where relevant, the following measurement uncertainty levels have been estimated for tests performed on the Product as specified in CISPR 16-4-2. This uncertainty represents an expanded uncertainty expressed at approximately the 95% confidence level using a coverage factor of $k=2$.

No.	Item	Uncertainty
1	3m chamber Radiated spurious emission(9kHz-30MHz)	U=3.7dB
2	3m chamber Radiated spurious emission(30MHz-1GHz)	U=4.3dB
3	3m chamber Radiated spurious emission(1GHz-18GHz)	U=4.5dB
4	3m chamber Radiated spurious emission(18GHz-40GHz)	U=3.34dB
5	Conducted Emission(150kHz-30MHz)	U=3.20dB
6	Conducted Adjacent channel power	U=1.38dB
7	Conducted output power uncertainty Above 1G	U=1.576dB
8	Conducted output power uncertainty below 1G	U=1.28dB
9	humidity uncertainty	U=5.3%
10	Temperature uncertainty	U=0.59°C

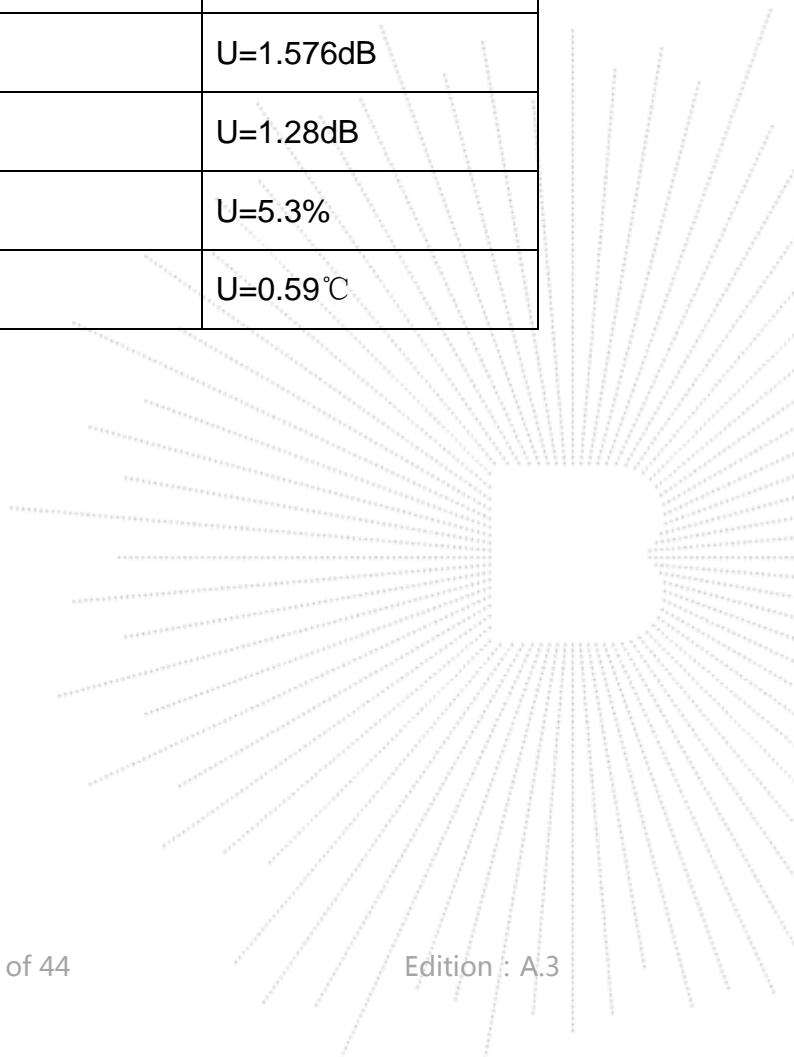

4. PRODUCT INFORMATION AND TEST SETUP

4.1 Product Information

Model/Type Ref.:	GS-SB60 GS-SB54, GS-SB55, GS-SB56, GS-SB57, GS-SB71
Model differences:	All the model are the same circuit and RF module, except model names.
Hardware Version:	N/A
Software Version:	N/A
Operation Frequency:	905 MHz 915 MHz 925MHz
Type of Modulation:	GFSK
Number Of Channel	3CH
Antenna installation:	Internal antenna
Antenna Gain:	0dBi
Rated Voltage:	AC 120V/60Hz
Adapter Information:	Model No.:GKYZC0200240US Input: AC 100-240V 50/60Hz 1.5A Output: DC 24V 2000mA

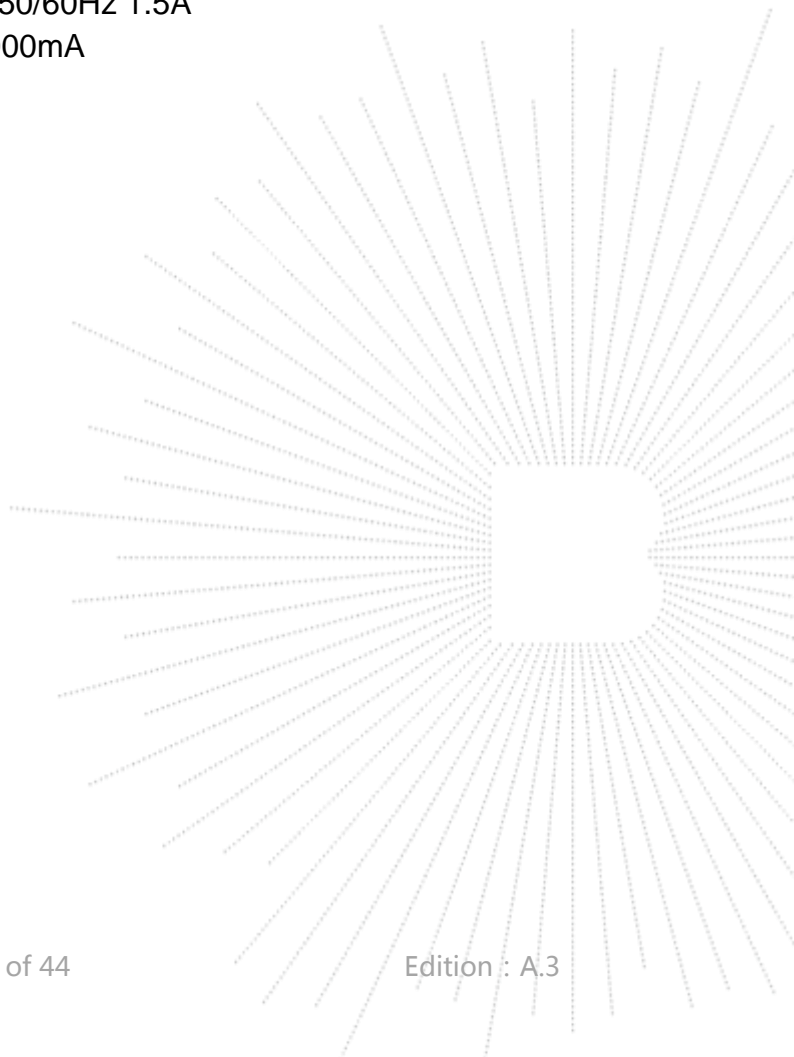

4.2 Test Setup Configuration

See test photographs attached in *EUT TEST SETUP PHOTOGRAPHS* for the actual connections between Product and support equipment.

Conducted Emission:

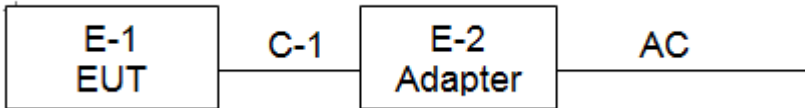

Radiated Spurious Emission

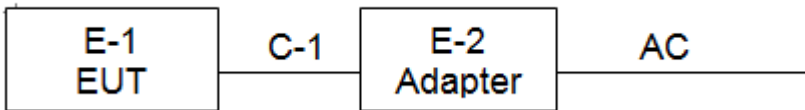

4.3 Support Equipment

	Device Type	Brand	Model	Series No.	Note
E-1	Soundbar	N/A	GS-SB60	GS-SB54,GS-SB55, GS-SB56, GS-SB57,GS-SB71	EUT

Item	Shielded Type	Ferrite Core	Length	Note
C-1	NO	NO	0.3M	DC cable unshielded

Notes:

1. All the equipment/cables were placed in the worst-case configuration to maximize the emission during the test.
2. Grounding was established in accordance with the manufacturer's requirements and conditions for the intended use.

4.4 Channel List

CH	Frequency (MHz)
01	905
02	915
03	925

4.5 Test Mode

To investigate the maximum EMI emission characteristics generates from EUT, the

test system was pre-scanning tested base on the consideration of following EUT operation mode or test configuration mode which possible have effect on EMI emission level. Each of these EUT operation mode(s) or test configuration mode(s) mentioned above was evaluated respectively.

For All Mode	Description	Modulation Type
Mode 1	CH01	GFSK
Mode 2	CH02	
Mode 3	CH03	
Mode 4	Link mode (Conducted emission and Radiated emission)	

Note:

- (1) The measurements are performed at the highest, middle, lowest available channels.
- (2) Fully-charged battery is used during the test

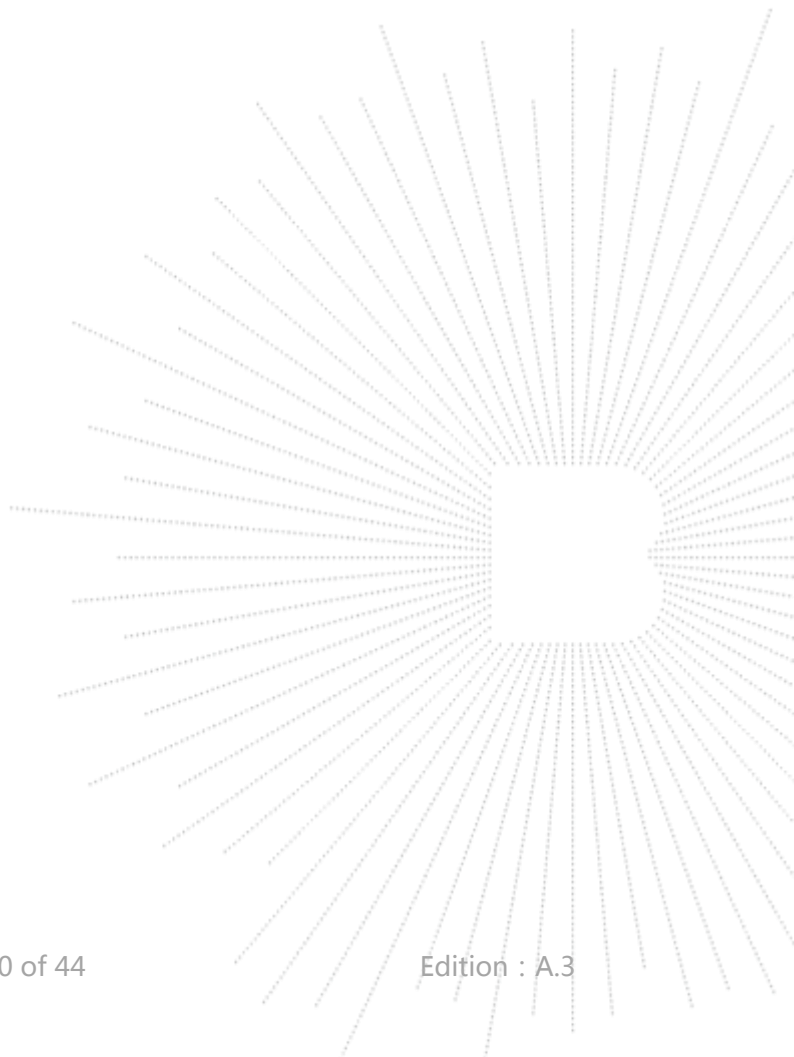

5. TEST FACILITY AND TEST INSTRUMENT USED

5.1 Test Facility

All measurement facilities used to collect the measurement data are located at Shenzhen BCTC Testing Co., Ltd. Address: 1-2/F., Building B, Pengzhou Industrial Park, No.158, Fuyuan 1st Road, Tangwei, Fuhai Subdistrict, Bao'an District, Shenzhen, Guangdong, China. The site and apparatus are constructed in conformance with the requirements of ANSI C63.4 and CISPR 16-1-1 other equivalent standards.

FCC Test Firm Registration Number: 712850

IC Registered No.: 23583

5.2 Test Instrument Used

Conducted emissions Test					
Equipment	Manufacturer	Model#	Serial#	Last Cal.	Next Cal.
Receiver	R&S	ESR3	102075	May 28, 2021	May 27, 2022
LISN	R&S	ENV216	101375	May 28, 2021	May 27, 2022
ISN	HPX	ISN T800	S1509001	May 28, 2021	May 27, 2022
Software	Frad	EZ-EMC	EMC-CON 3A1	\	\

Radiated emissions Test (966 chamber)					
Equipment	Manufacturer	Model#	Serial#	Last Cal.	Next Cal.
966 chamber	ChengYu	966 Room	966	Jun. 06. 2020	Jun. 05, 2023
Receiver	R&S	ESR3	102075	May 28, 2021	May 27, 2022
Receiver	R&S	ESRP	101154	May 28, 2021	May 27, 2022
Amplifier	SKET	LAPA_01G 18G-45dB	\	May 28, 2021	May 27, 2022
Amplifier	Schwarzbeck	BBV9744	9744-0037	May 28, 2021	May 27, 2022
TRILOG Broadband Antenna	schwarzbeck	VULB 9163	VULB9163- 942	Jun. 01, 2021	May 31, 2022
Horn Antenna	SCHWARZBE CK	BBHA9120 D	1541	Jun. 02, 2021	Jun. 01, 2022
Horn Antenna (18GHz-40 GHz)	SCHWARZBE CK	BBHA9170	822	May 28, 2021	May 27, 2022
Amplifier (18GHz-40 GHz)	MITEQ	TTA1840-3 5-HG	2034381	May 28, 2021	May 27, 2022
Loop Antenna (9KHz-30M Hz)	SCHWARZBE CK	FMZB1519 B	014	Jun. 02, 2021	Jun. 01, 2022
RF cables1 (9kHz-30MH z)	Huber+Suhnar	9kHz-30M Hz	B1702988- 0008	May 28, 2021	May 27, 2022
RF cables2 (30MHz-1G Hz)	Huber+Suhnar	30MHz-1G Hz	1486150	May 28, 2021	May 27, 2022
RF cables3 (1GHz-40G Hz)	Huber+Suhnar	1GHz-40G Hz	1607106	May 28, 2021	May 27, 2022
Power Metter	Keysight	E4419B	\	May 28, 2021	May 27, 2022
Power Sensor (AV)	Keysight	E9 300A	\	May 28, 2021	May 27, 2022
Signal Analyzer 20kHz-26.5 GHz	KEYSIGHT	N9020A	MY491000 60	May 28, 2021	May 27, 2022
Spectrum Analyzer 9kHz-40G Hz	R&S	FSP40	100363	May 28, 2021	May 27, 2022
Software	Frad	EZ-EMC	FA-03A2 RE	\	\

5. CONDUCTED EMISSIONS

5.1 Block Diagram Of Test Setup

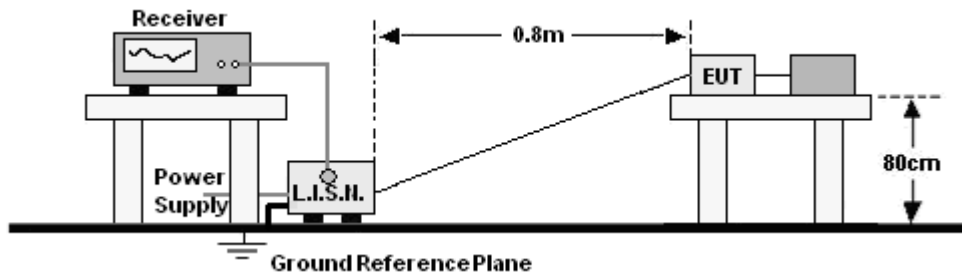

5.2 Limit

FREQUENCY (MHz)	Limit (dBuV)	
	Quas-peak	Average
0.15 -0.5	66 - 56 *	56 - 46 *
0.50 -5.0	56.00	46.00
5.0 -30.0	60.00	50.00

Notes:

- *Decreasing linearly with logarithm of frequency.
- The lower limit shall apply at the transition frequencies.

5.3 Test procedure

Receiver Parameters	Setting
Attenuation	10 dB
Start Frequency	0.15 MHz
Stop Frequency	30 MHz
IF Bandwidth	9 kHz

a. The Product was placed on a nonconductive table 0.8 m above the horizontal ground reference plane, and 0.4 m from the vertical ground reference plane, and connected to the main through Line Impedance Stability Network (L.I.S.N).

b. The RBW of the receiver was set at 9 kHz in 150 kHz ~ 30MHz with Peak and AVG detector in Max Hold mode. Run the receiver's pre-scan to record the maximum disturbance generated from Product in all power lines in the full band.

c. For each frequency whose maximum record was higher or close to limit, measure its QP and AVG values and record.

5.4 EUT operating Conditions

The EUT was configured for testing in a typical fashion (as a customer would normally use it). The EUT has been programmed to continuously transmit during test. This operating condition was tested and used to collect the included data.

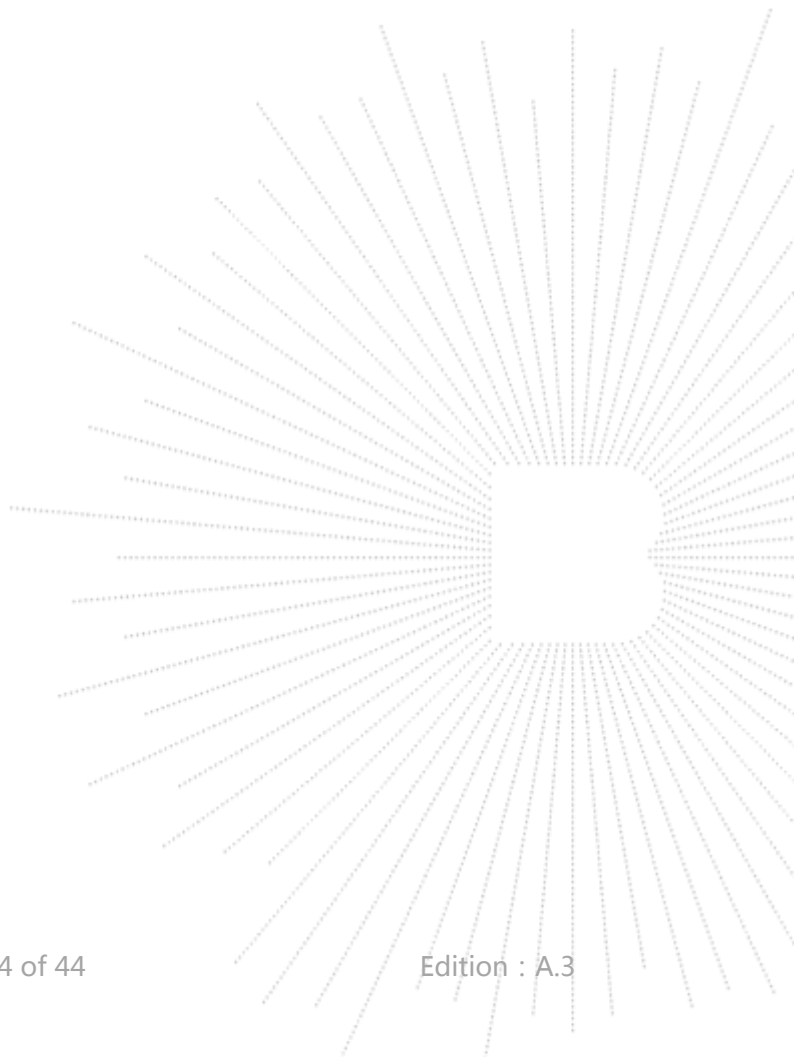

5.5 Test Result

Soundbar

Temperature :	26 °C	Relative Humidity :	54%
Pressure :	101kPa	Phase :	L
Test Voltage :	AC 120V/60Hz	Test Mode :	Mode 4

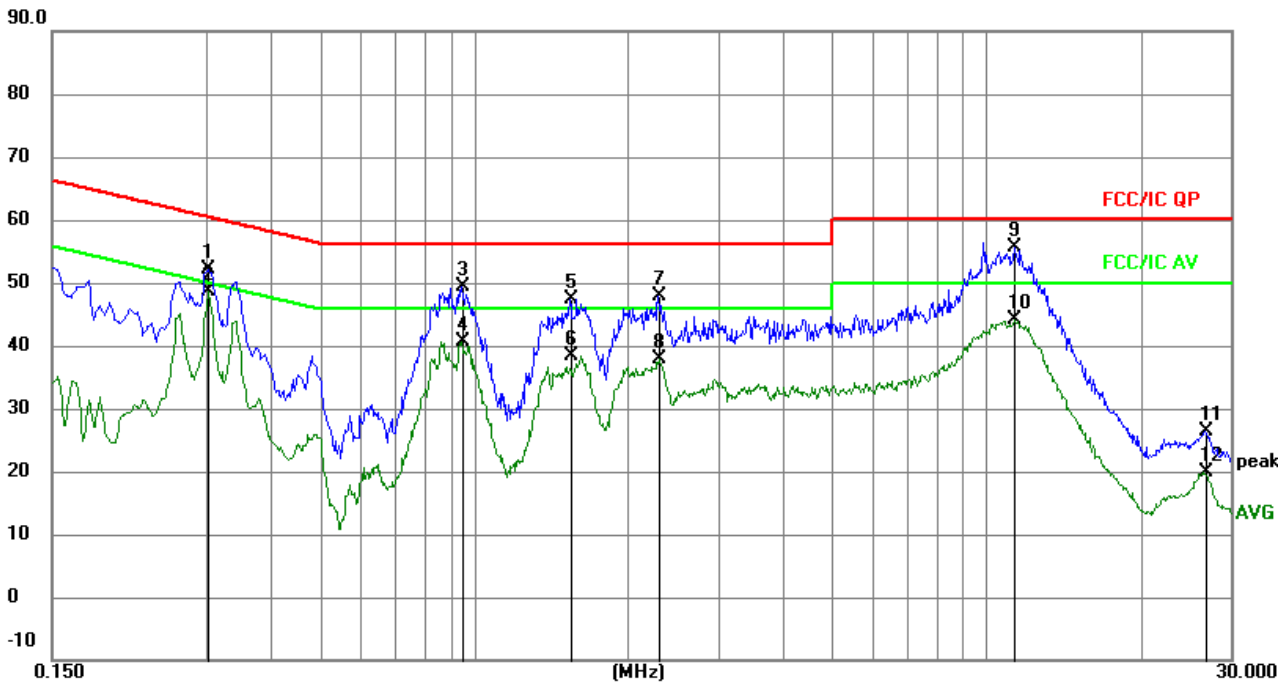

Remark:

1. All readings are Quasi-Peak and Average values.
2. Factor = Insertion Loss + Cable Loss.

No.	Mk.	Freq. MHz	Reading Level	Correct Factor dB	Measure- ment dBuV	Limit dBuV	Over dB	Detector
1		0.3017	42.46	9.58	52.04	60.20	-8.16	QP
2	*	0.3017	38.98	9.58	48.56	50.20	-1.64	AVG
3		0.9465	39.73	9.59	49.32	56.00	-6.68	QP
4		0.9465	31.09	9.59	40.68	46.00	-5.32	AVG
5		1.5360	37.84	9.58	47.42	56.00	-8.58	QP
6		1.5360	28.72	9.58	38.30	46.00	-7.70	AVG
7		2.2920	38.25	9.61	47.86	56.00	-8.14	QP
8		2.2920	28.18	9.61	37.79	46.00	-8.21	AVG
9		11.3505	45.92	9.69	55.61	60.00	-4.39	QP
10		11.3505	34.53	9.69	44.22	50.00	-5.78	AVG
11		26.7900	16.55	9.73	26.28	60.00	-33.72	QP
12		26.7900	10.12	9.73	19.85	50.00	-30.15	AVG

Soundbar

Temperature :	26 °C	Relative Humidity :	54%
Pressure :	101kPa	Phase :	N
Test Voltage :	AC 120V/60Hz	Test Mode :	Mode 4

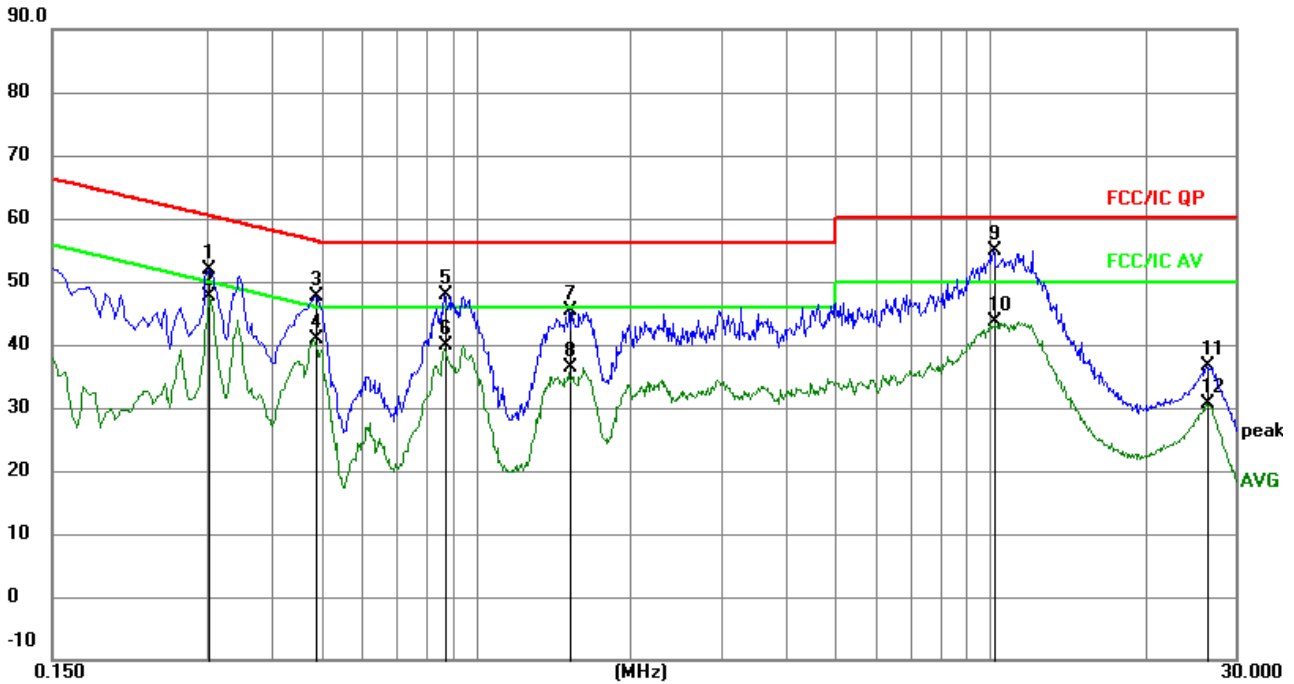
Remark:

1. All readings are Quasi-Peak and Average values.
2. Factor = Insertion Loss + Cable Loss.

No.	Mk.	Freq. MHz	Reading Level	Correct Factor dB	Measurement dBuV	Limit dBuV	Over dB	Detector
1		0.3030	42.37	9.58	51.95	60.16	-8.21	QP
2	*	0.3030	38.16	9.58	47.74	50.16	-2.42	AVG
3		0.4875	38.08	9.58	47.66	56.21	-8.55	QP
4		0.4875	31.24	9.58	40.82	46.21	-5.39	AVG
5		0.8700	38.28	9.61	47.89	56.00	-8.11	QP
6		0.8700	30.30	9.61	39.91	46.00	-6.09	AVG
7		1.5225	35.90	9.58	45.48	56.00	-10.52	QP
8		1.5225	26.79	9.58	36.37	46.00	-9.63	AVG
9		10.1760	45.30	9.69	54.99	60.00	-5.01	QP
10		10.1760	34.05	9.69	43.74	50.00	-6.26	AVG
11		26.3760	26.90	9.73	36.63	60.00	-23.37	QP
12		26.3760	20.82	9.73	30.55	50.00	-19.45	AVG

6. RADIATED EMISSIONS

6.1 Block Diagram Of Test Setup

(A) Radiated Emission Test-Up Frequency Below 30MHz

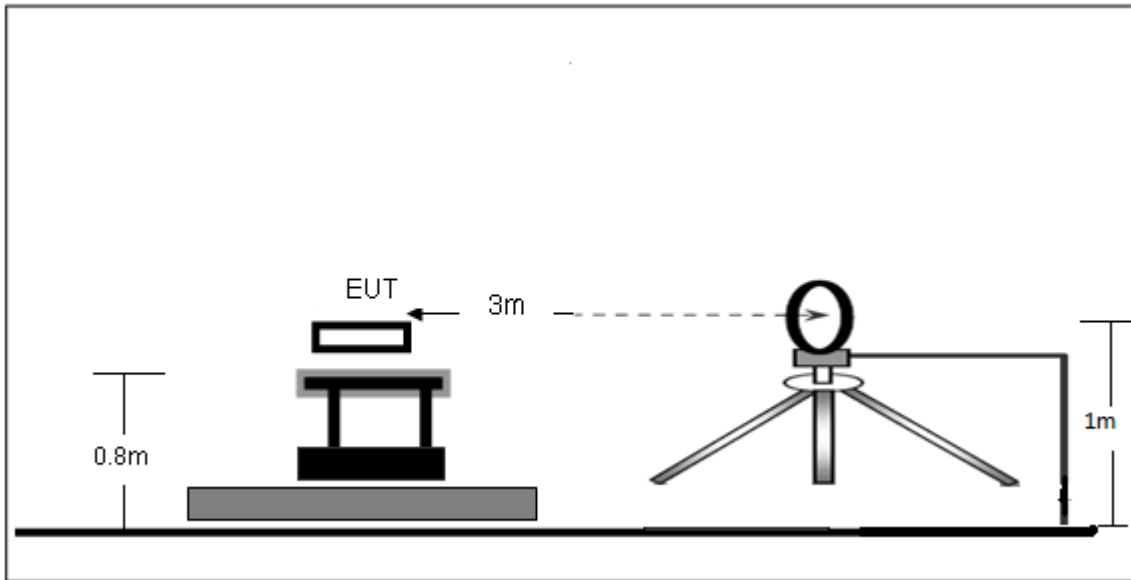

(B) Radiated Emission Test-Up Frequency 30MHz~1GHz

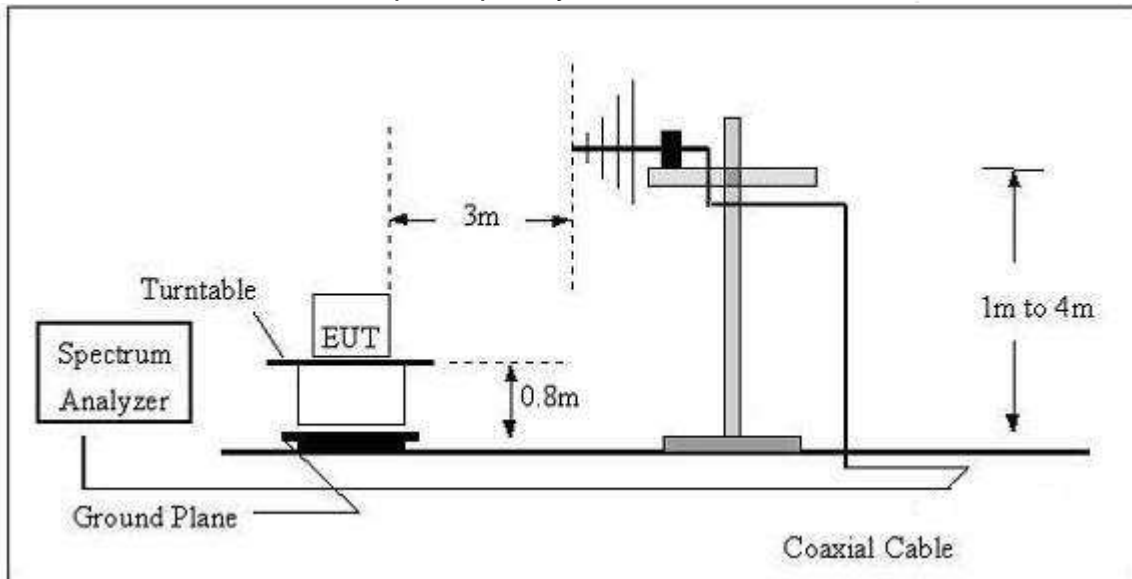

(C) Radiated Emission Test-Up Frequency Above 1GHz

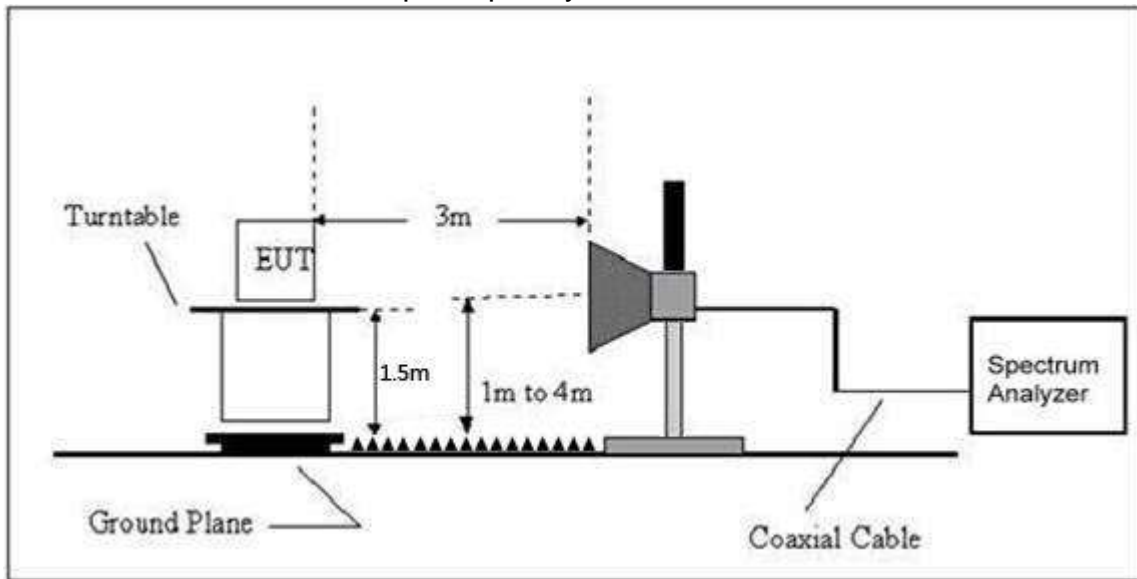

6.2 Limit

20dBc in any 100 kHz bandwidth outside the operating frequency band. In case the emission fall within the restricted band specified on 15.205(a), then the 15.209(a) limit in the table below has to be followed.

Frequency (MHz)	Field Strength uV/m	Distance (m)	Field Strength Limit at 3m Distance	
			uV/m	dBuV/m
0.009 ~ 0.490	2400/F(kHz)	300	$10000 * 2400/F(\text{kHz})$	$20\log^{(2400/F(\text{kHz}))} + 80$
0.490 ~ 1.705	24000/F(kHz)	30	$100 * 24000/F(\text{kHz})$	$20\log^{(24000/F(\text{kHz}))} + 40$
1.705 ~ 30	30	30	$100 * 30$	$20\log^{(30)} + 40$
30 ~ 88	100	3	100	$20\log^{(100)}$
88 ~ 216	150	3	150	$20\log^{(150)}$
216 ~ 960	200	3	200	$20\log^{(200)}$
Above 960	500	3	500	$20\log^{(500)}$

The field strength of emissions from intentional radiators operated within these frequency bands shall comply with the following:

Fundamental frequency	Field strength of fundamental (millivolts/meter)	Field strength of harmonics (microvolts/meter)
902-928 MHz	50	500
2400-2483.5 MHz	50	500
5725-5875 MHz	50	500
24.0-24.25 GHz	250	2500

LIMITS OF RADIATED EMISSION MEASUREMENT (Above 1000MHz)

FREQUENCY (MHz)	Limit (dBuV/m) (at 3M)	
	PEAK	AVERAGE
Above 1000	74	54

Notes:

- (1) The limit for radiated test was performed according to FCC PART 15C.
- (2) The tighter limit applies at the band edges.
- (3) Emission level (dBuV/m)=20log Emission level (uV/m).

FREQUENCY RANGE OF RADIATED MEASUREMENT (For unintentional radiators)

Highest frequency generated or Upper frequency of measurement used in the device or on which the device operates or tunes (MHz)	Range (MHz)
Below 1.705	30
1.705 – 108	1000
108 – 500	2000
500 – 1000	5000
Above 1000	5 th harmonic of the highest frequency or 40 GHz, whichever is lower

6.3 Test procedure

Spectrum Parameter	Setting
Attenuation	Auto
Start Frequency	1000 MHz
Stop Frequency	10th carrier harmonic
RB / VB (emission in restricted band)	1 MHz / 1 MHz for Peak, 1 MHz / 10Hz for Average

Receiver Parameter	Setting
Attenuation	Auto
Start ~ Stop Frequency	9kHz~150kHz / RB 200Hz for QP
Start ~ Stop Frequency	150kHz~30MHz / RB 9kHz for QP
Start ~ Stop Frequency	30MHz~1000MHz / RB 120kHz for QP

Below 1GHz test procedure as below:

- a. The EUT was placed on the top of a rotating table 0.8 meters above the ground at a 3 meter semi-anechoic chamber. The table was rotated 360 degrees to determine the position of the highest radiation.
- b. The EUT was set 3 meters away from the interference-receiving antenna, which was mounted on the top of a variable-height antenna tower.
- c. The antenna height is varied from one meter to four meters above the ground to determine the maximum value of the field strength. Both horizontal and vertical polarizations of the antenna are set to make the measurement.
- d. For each suspected emission, the EUT was arranged to its worst case and then the antenna was tuned to heights from 1 meter to 4 meters (for the test frequency of below 30MHz, the antenna was tuned to heights 1 meter) and the rotatable table was turned from 0 degrees to 360 degrees to find the maximum reading.
- e. The test-receiver system was set to Peak Detect Function and Specified Bandwidth with Maximum Hold Mode.
- f. If the emission level of the EUT in peak mode was 10dB lower than the limit specified, then testing could be stopped and the peak values of the EUT would be reported. Otherwise the emissions that did not have 10dB margin would be re-tested one by one using peak, quasi-peak or average method as specified and then reported in a data sheet.

Above 1GHz test procedure as below:

- g. Different between above is the test site, change from Semi- Anechoic Chamber to fully Anechoic Chamber and change form table 0.8 metre to 1.5 metre(Above 18GHz the distance is 1 meter and table is 1.5 metre).
- h. Test the EUT in the lowest channel ,the middle channel ,the Highest channel.

Note:

Both horizontal and vertical antenna polarities were tested and performed pretest to three orthogonal axis. The worst case emissions were reported.

Above 1GHz test procedure as below:

- a. The EUT was placed on the top of a rotating table 1.5 meters above the ground at a 3 meter chamber. The table was rotated 360 degrees to determine the position of the highest radiation.
- b. The EUT was set 3 meters away from the interference-receiving antenna, which was mounted on the top of a variable-height antenna tower.

c. The antenna height is varied from one meter to four meters above the ground to determine the maximum value of the field strength. Both horizontal and vertical polarizations of the antenna are set to make the measurement.

d. For each suspected emission, the EUT was arranged to its worst case and then the antenna was tuned to heights from 1 meter to 4 meters and the rota table was turned from 0 degrees to 360 degrees to find the maximum reading.

e. The test-receiver system was set to Peak Detect Function and Specified Bandwidth with Maximum Hold Mode.

f. If the emission level of the EUT in peak mode was 10dB lower than the limit specified, then testing could be stopped and the peak values of the EUT would be reported. Otherwise the emissions that did not have 10dB margin would be re-tested one by one using peak, quasi-peak or average method as specified and then reported in a data sheet.

g. Test the EUT in the lowest channel, the Highest channel.

Note:

Both horizontal and vertical antenna polarities were tested and performed pretest to three orthogonal axis. The worst case emissions were reported.

6.4 EUT operating Conditions

The EUT was configured for testing in a typical fashion (as a customer would normally use it). The EUT has been programmed to continuously transmit during test. This operating condition was tested and used to collect the included data.

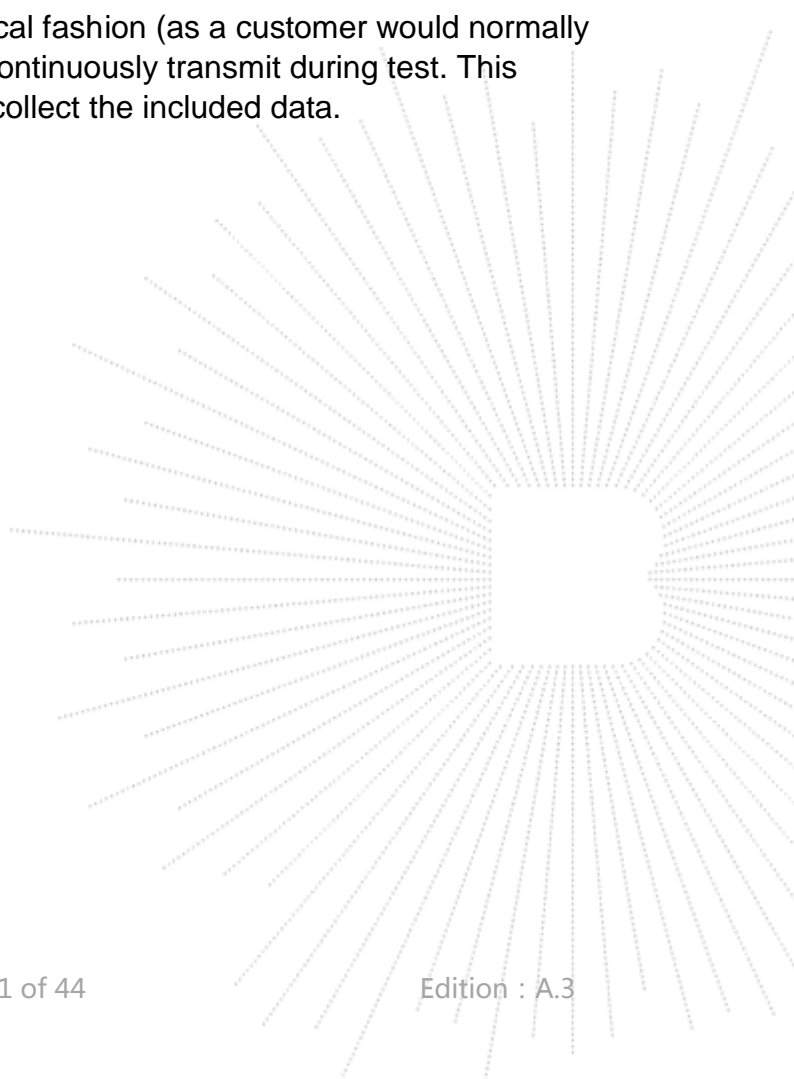

6.5 Test Result

Below 30MHz

Temperature:	26°C	Relative Humidity:	24%
Pressure:	101 kPa	Test Voltage :	AC120V/60Hz
Test Mode:	Mode 4	Polarization :	--

Freq. (MHz)	Reading (dBuV/m)	Limit (dBuV/m)	Margin (dB)	State P/F
--	--	--	--	PASS
--	--	--	--	PASS

Note:

The amplitude of spurious emissions which are attenuated by more than 20dB below the permissible value has no need to be reported.

Distance extrapolation factor = $40 \log (\text{specific distance}/\text{test distance})(\text{dB})$;

Limit line = specific limits(dBuv) + distance extrapolation factor.

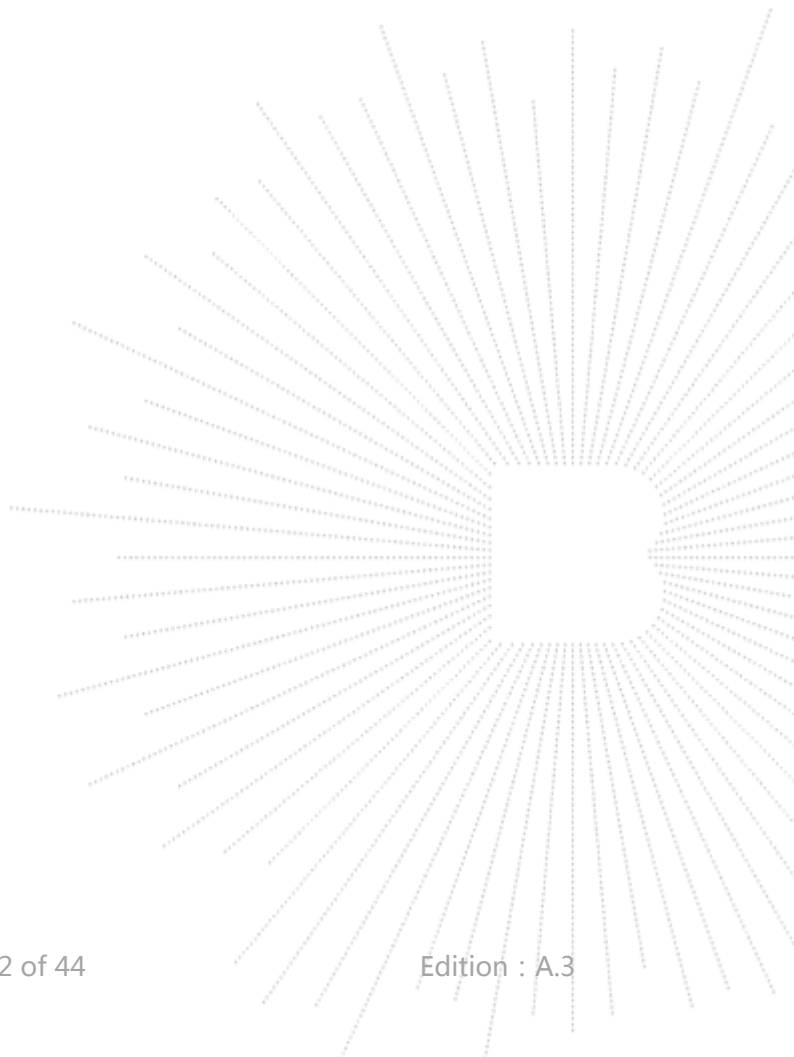

Between 30MHz – 1GHz

Temperature:	26°C	Relative Humidity:	54%
Pressure:	101 kPa	Test Voltage :	AC120V/60Hz
Test Mode :	Mode 4	Polarization :	Horizontal

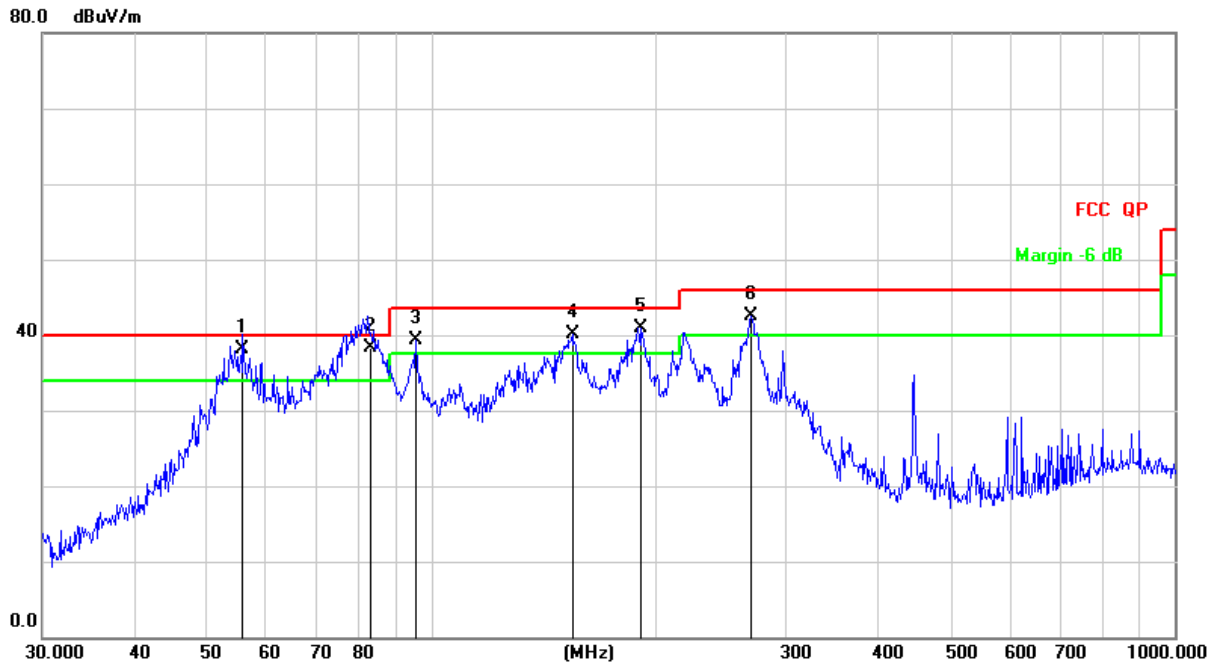

Remark:

Factor = Antenna Factor + Cable Loss – Pre-amplifier.

No.	Mk.	Freq. MHz	Reading Level dBuV	Correct Factor dB	Measure- ment dBuV/m	Limit dB/m	Over dB	Detector
1	!	55.8047	52.53	-14.42	38.11	40.00	-1.89	QP
2	*	82.9896	57.21	-18.91	38.30	40.00	-1.70	QP
3	!	95.4270	55.77	-16.39	39.38	43.50	-4.12	QP
4	!	154.8204	58.46	-18.38	40.08	43.50	-3.42	QP
5	!	191.7450	56.76	-15.83	40.93	43.50	-2.57	QP
6	!	269.4284	56.00	-13.52	42.48	46.00	-3.52	QP

Temperature:	26°C	Relative Humidity:	54%
Pressure:	101 kpa	Test Voltage :	AC120V/60Hz
Test Mode :	Mode 4	Polarization :	Vertical

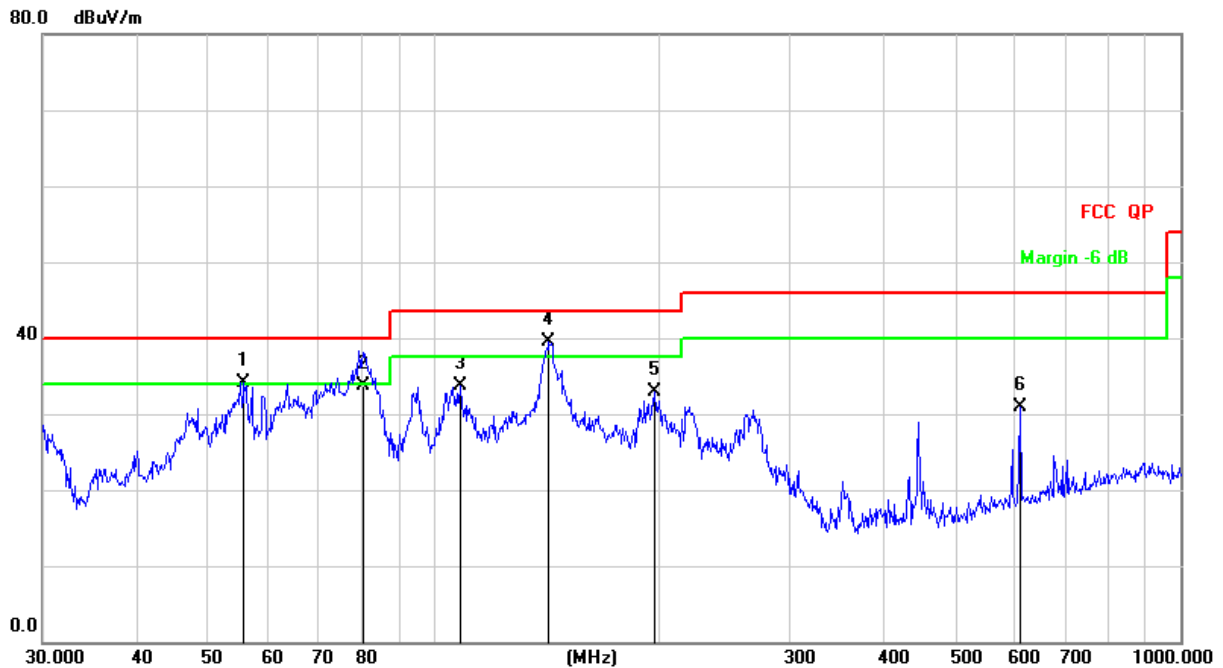

Remark:

Factor = Antenna Factor + Cable Loss – Pre-amplifier.

No.	Mk.	Freq. MHz	Reading Level dBuV	Correct Factor dB	Measure- ment dBuV/m	Limit dB/m	Over dB	Detector
1	!	55.8046	48.61	-14.42	34.19	40.00	-5.81	QP
2		80.7199	53.10	-19.36	33.74	40.00	-6.26	QP
3		108.6470	49.74	-16.03	33.71	43.50	-9.79	QP
4	*	142.8243	57.76	-18.25	39.51	43.50	-3.99	QP
5		197.8926	48.40	-15.41	32.99	43.50	-10.51	QP
6		609.9215	35.89	-4.90	30.99	46.00	-15.01	QP

(Above 1000 MHz)
Normal Voltage 905MHz

Polar (H/V)	Frequency	Meter Reading	Factor	Emission Level	Limits	Margin	Detector Type
	(MHz)	(dBuV)	(dB)	(dBuV/m)	(dBuV/m)	(dB)	
V	1810.00	52.03	-0.43	51.60	74.00	-22.40	PK
V	1810.00	43.87	-0.43	43.44	54.00	-10.56	AV
V	2715.00	43.22	8.31	51.53	74.00	-22.47	PK
V	2715.00	32.87	8.31	41.18	54.00	-12.82	AV
V	3620.00	44.51	8.31	52.82	74.00	-21.18	PK
V	3620.00	34.38	8.31	42.69	54.00	-11.31	AV
H	1810.00	51.17	-0.43	50.74	74.00	-23.26	PK
H	1810.00	40.17	-0.43	39.74	54.00	-14.26	AV
H	2715.00	40.99	8.31	49.30	74.00	-24.70	PK
H	2715.00	33.64	8.31	41.95	54.00	-12.05	AV
H	3620.00	42.36	8.31	50.67	74.00	-23.33	PK
H	3620.00	33.69	8.31	42.00	54.00	-12.00	AV

Remark:

Absolute Level= ReadingLevel+ Factor, Margin= Limit- Absolute Level

Other harmonics emissions are lower than 20dB below the allowable limit.

Normal Voltage 915MHz

Polar (H/V)	Frequency	Meter Reading	Factor	Emission Level	Limits	Margin	Detector Type
	(MHz)	(dBuV)	(dB)	(dBuV/m)	(dBuV/m)	(dB)	
V	1830.00	52.39	-0.43	51.96	74.00	-22.04	PK
V	1830.00	42.83	-0.43	42.40	54.00	-11.60	AV
V	2745.00	44.38	8.31	52.69	74.00	-21.31	PK
V	2745.00	35.07	8.31	43.38	54.00	-10.62	AV
V	3660.00	46.16	8.31	54.47	74.00	-19.53	PK
V	3660.00	35.74	8.31	44.05	54.00	-9.95	AV
H	1830.00	48.62	-0.43	48.19	74.00	-25.81	PK
H	1830.00	38.20	-0.43	37.77	54.00	-16.23	AV
H	2745.00	41.68	8.31	49.99	74.00	-24.01	PK
H	2745.00	34.19	8.31	42.50	54.00	-11.50	AV
H	3660.00	43.74	8.31	52.05	74.00	-21.95	PK
H	3660.00	36.02	8.31	44.33	54.00	-9.67	AV

Remark:

Absolute Level= ReadingLevel+ Factor, Margin= Limit- Absolute Level

Other harmonics emissions are lower than 20dB below the allowable limit.

Normal Voltage 925MHz

Polar (H/V)	Frequency	Meter Reading	Factor	Emission Level	Limits	Margin	Detector Type
	(MHz)	(dBuV)	(dB)	(dBuV/m)	(dBuV/m)	(dB)	
V	1850.00	52.81	-0.43	52.38	74.00	-21.62	PK
V	1850.00	43.95	-0.43	43.52	54.00	-10.48	AV
V	2775.00	45.30	8.31	53.61	74.00	-20.39	PK
V	2775.00	35.42	8.31	43.73	54.00	-10.27	AV
V	3700.00	49.75	44.72	8.31	53.03	74.00	-20.97
V	3700.00	48.63	35.53	8.31	43.84	54.00	-10.16
H	1850.00	50.00	-0.43	49.57	74.00	-24.43	PK
H	1850.00	39.98	-0.43	39.55	54.00	-14.45	AV
H	2775.00	43.67	8.31	51.98	74.00	-22.02	PK
H	2775.00	36.26	8.31	44.57	54.00	-9.43	AV
H	3700.00	42.66	8.31	50.97	74.00	-23.03	PK
H	3700.00	34.27	8.31	42.58	54.00	-11.42	AV

Remark:
 Absolute Level= ReadingLevel+ Factor, Margin= Limit- Absolute Level
 Other harmonics emissions are lower than 20dB below the allowable limit.

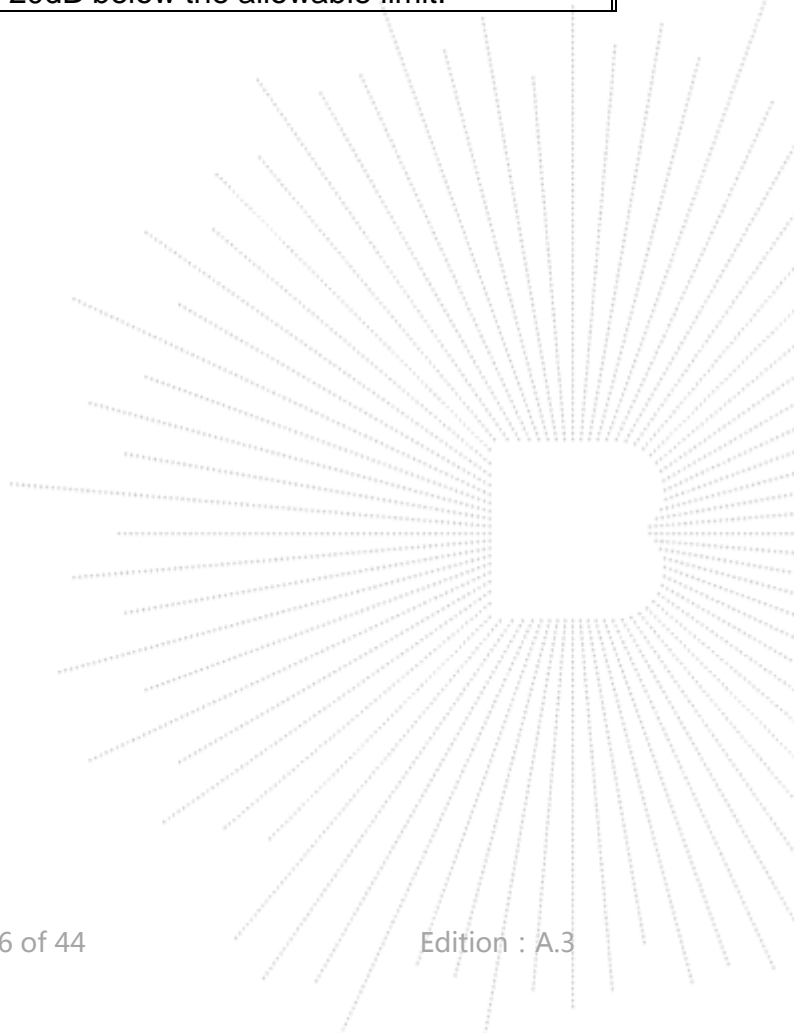

6.6 Field Strength Calculation

The field strength is calculated by adding the Antenna Factor and Cable Factor and subtracting the Amplifier Gain and Duty Cycle Correction Factor (if any) from the measured reading. The basic equation with a sample calculation is as follows:

$$FS=RA+AF+CL-AG$$

FS=Field Strength	CL=Cable Attenuation Factor (Cable Loss)
RA=Reading Amplitude	AG=Amplifier Gain
AF=Antenna Factor	

Test Result:

Temperature:	26°C	Relative Humidity:	54%
Pressure:	101kPa	Polarization :	Horizontal
Test Voltage :	DC 5V		
Test Mode :	Mode 1		

Frequency (MHz)	Meter Reading (dB μ V)	Factor (dB)	Emission Level (dB μ V/m)	Limits (dB μ V/m)	Margin (dB)	Detector Type
905	77.55	-0.19	77.36	114.00	-36.64	Peak
905	78.56	-0.19	78.37	94.00	-15.63	Average

Remark:

Factor = Antenna Factor + Cable Loss - Pre-amplifier.
All interfaces was connected, and TX mode

Temperature:	26°C	Relative Humidity:	54%
Pressure:	101kPa	Polarization :	Vertical
Test Voltage :	DC 5V		
Test Mode :	Mode 1		

Frequency (MHz)	Meter Reading (dB μ V)	Factor (dB)	Emission Level (dB μ V/m)	Limits (dB μ V/m)	Margin (dB)	Detector Type
905	76.68	-0.19	76.49	114.00	-37.51	Peak
905	75.69	-0.19	75.50	94.00	-18.50	Average

Remark:

Factor = Antenna Factor + Cable Loss - Pre-amplifier.
All interfaces was connected, and TX mode

Temperature:	26°C	Relative Humidity:	54%
Pressure:	101kPa	Polarization :	Horizontal
Test Voltage :	DC 5V		
Test Mode :	Mode 1		

Frequency (MHz)	Meter Reading (dB μ V)	Factor (dB)	Emission Level (dB μ V/m)	Limits (dB μ V/m)	Margin (dB)	Detector Type
915	78.05	-0.19	77.86	114.00	-36.14	Peak
915	75.43	-0.19	75.24	94.00	-18.76	Average

Remark:

Factor = Antenna Factor + Cable Loss - Pre-amplifier.
All interfaces was connected, and TX mode

Temperature:	26°C	Relative Humidity:	54%
Pressure:	101kPa	Polarization :	Vertical
Test Voltage :	DC 5V		
Test Mode :	Mode 1		

Frequency (MHz)	Meter Reading (dB μ V)	Factor (dB)	Emission Level (dB μ V/m)	Limits (dB μ V/m)	Margin (dB)	Detector Type
915	79.52	-0.19	79.33	114.00	-34.67	Peak
915	74.63	-0.19	74.44	94.00	-19.56	Average

Remark:

Factor = Antenna Factor + Cable Loss - Pre-amplifier.
All interfaces was connected, and TX mode

Temperature:	26°C	Relative Humidity:	54%
Pressure:	101kPa	Polarization :	Horizontal
Test Voltage :	DC 5V		
Test Mode :	Mode 1		

Frequency	Meter Reading	Factor	Emission Level	Limits	Margin	Detector Type
(MHz)	(dB μ V)	(dB)	(dB μ V/m)	(dB μ V/m)	(dB)	
925	77.51	-0.19	77.32	114.00	-36.68	Peak
925	76.46	-0.19	76.27	94.00	-17.73	Average

Remark:

Factor = Antenna Factor + Cable Loss - Pre-amplifier.

All interfaces was connected, and TX mode

Temperature:	26°C	Relative Humidity:	54%
Pressure:	101kPa	Polarization :	Vertical
Test Voltage :	DC 5V		
Test Mode :	Mode 1		

Frequency	Meter Reading	Factor	Emission Level	Limits	Margin	Detector Type
(MHz)	(dB μ V)	(dB)	(dB μ V/m)	(dB μ V/m)	(dB)	
925	78.69	-0.19	78.50	114.00	-35.50	Peak
925	79.36	-0.19	79.17	94.00	-14.83	Average

Remark:

Factor = Antenna Factor + Cable Loss - Pre-amplifier.

All interfaces was connected, and TX mode

7. 100 KHZ BANDWIDTH OF FREQUENCY BAND EDGE

7.1 Block Diagram Of Test Setup

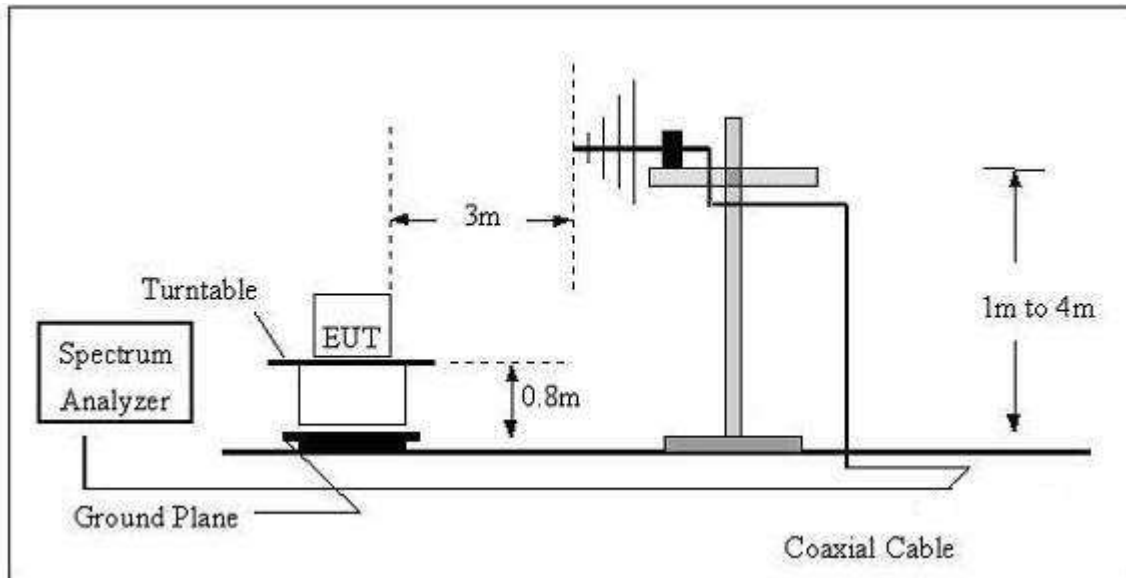

7.2 Applicable Standard

Emissions radiated outside of the specified frequency bands, except for harmonics, shall be attenuated by at least 50 dB below the level of the fundamental or to the general radiated emission limits in § 15.209, whichever is the lesser attenuation

7.3 Test procedure

- Check the calibration of the measuring instrument using either an internal calibrator or a known signal from an external generator.
- Position the EUT without connection to measurement instrument. Turn on the EUT and connect its antenna terminal to measurement instrument via a low loss cable. Then set it to any one measured frequency within its operating range, and make sure the instrument is operated in its linear range.
- VBW for Peak, Quasi-peak, or Average Detector Function: $3 \times \text{RBW}$
- Repeat above procedures until all measured frequencies were complete.

Note:

Both horizontal and vertical antenna polarities were tested and performed pretest to three orthogonal axis. The worst case emissions were reported.

7.4 EUT operating Conditions

The EUT tested system was configured as the statements of 2.4 Unless otherwise a special operating condition is specified in the follows during the testing.

7.5 Test Result

Temperature:	26 °C	Relative Humidity:	54%
Pressure:	101 kPa	Test Voltage :	AC120V/60Hz
Test Mode :	Mode 1		

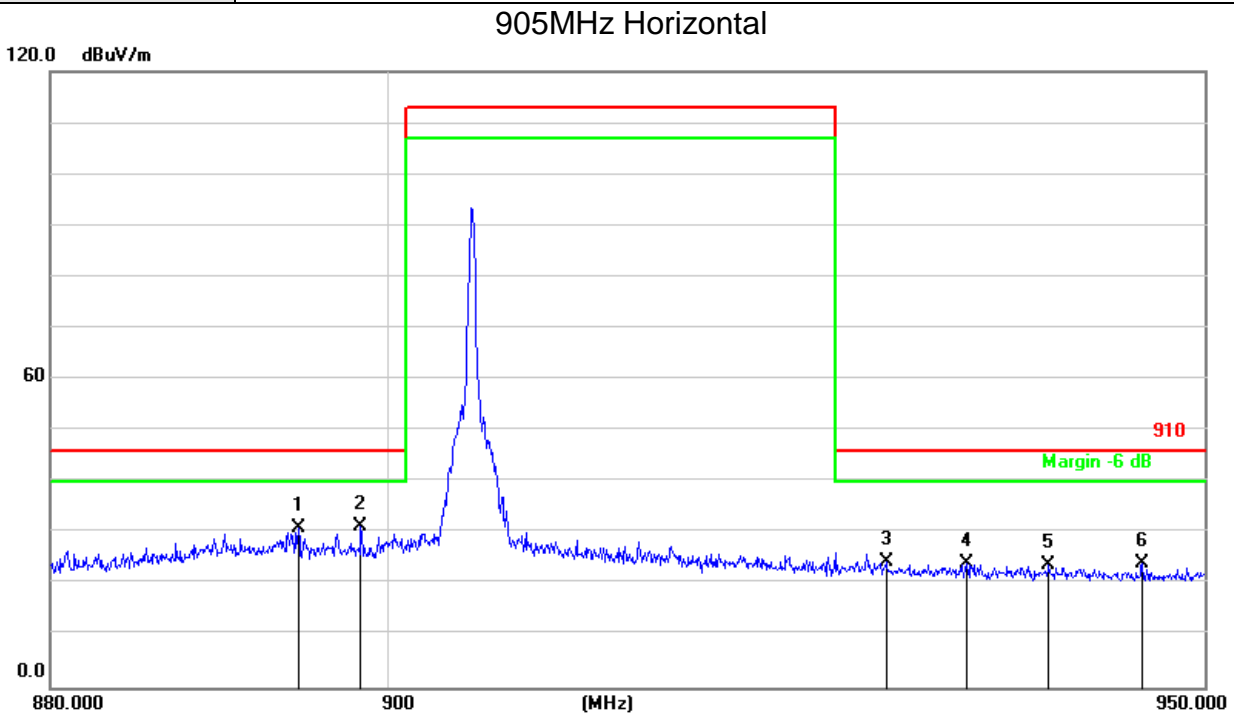

No.	Mk.	Freq. MHz	Reading Level dBuV	Correct Factor dB	Measure- ment dBuV/m	Limit dB/m	Over dB	Detector
1		894.6300	32.59	-1.61	30.98	46.00	-15.02	peak
2	*	898.3400	32.96	-1.53	31.43	46.00	-14.57	peak
3		930.1900	25.64	-1.26	24.38	46.00	-21.62	peak
4		935.1599	25.40	-1.23	24.17	46.00	-21.83	peak
5		940.2700	24.90	-1.19	23.71	46.00	-22.29	peak
6		946.1499	25.18	-1.14	24.04	46.00	-21.96	peak

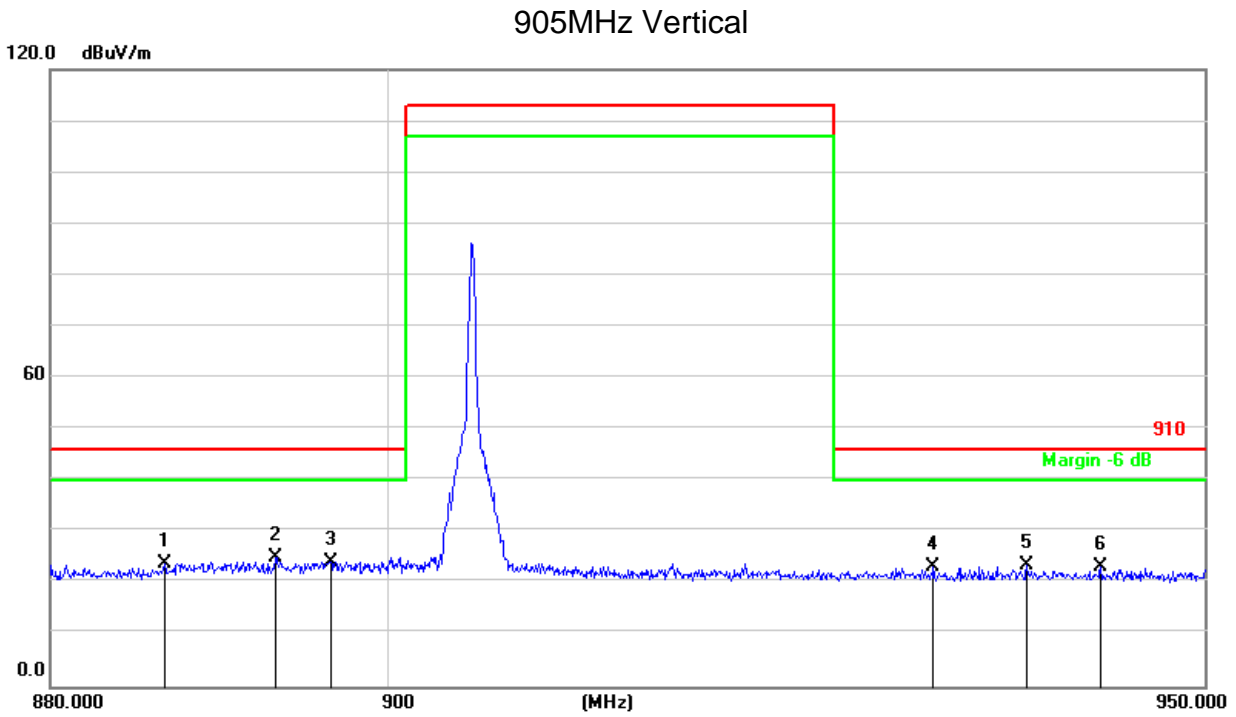

No.	Mk.	Freq. MHz	Reading Level dBuV	Correct Factor dB	Measure- ment dBuV/m	Limit dB/m	Over dB	A I Detector
1		886.7200	25.52	-1.77	23.75	46.00	-22.25	peak
2	*	893.3000	26.80	-1.64	25.16	46.00	-20.84	peak
3		896.5204	25.62	-1.57	24.05	46.00	-21.95	peak
4		933.1299	24.37	-1.24	23.13	46.00	-22.87	peak
5		938.8700	24.67	-1.20	23.47	46.00	-22.53	peak
6		943.4900	24.45	-1.16	23.29	46.00	-22.71	peak

Temperature:	26 °C	Relative Humidity:	54%
Pressure:	101 kPa	Test Voltage :	AC120V/60Hz
Test Mode :	Mode 2		

915MHz Horizontal

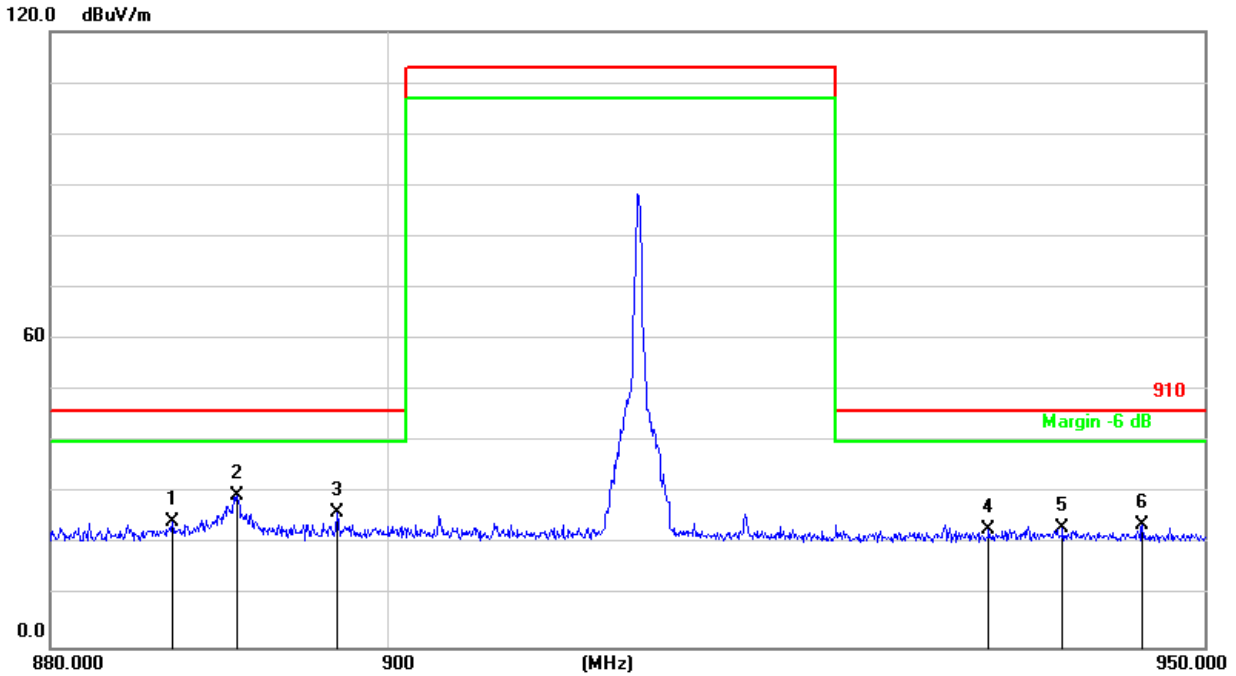

No.	Mk.	Freq. MHz	Reading Level dBuV	Correct Factor dB	Measure- ment dBuV/m	Limit dB/m	Over dB	Detector
1		887.2100	26.31	-1.76	24.55	46.00	-21.45	Peak
2	*	890.9900	31.17	-1.68	29.49	46.00	-16.51	Peak
3		896.9400	27.85	-1.56	26.29	46.00	-19.71	Peak
4		936.5600	24.05	-1.21	22.84	46.00	-23.16	Peak
5		941.1100	24.32	-1.18	23.14	46.00	-22.86	Peak
6		946.1500	25.07	-1.14	23.93	46.00	-22.07	Peak

915MHz Vertical

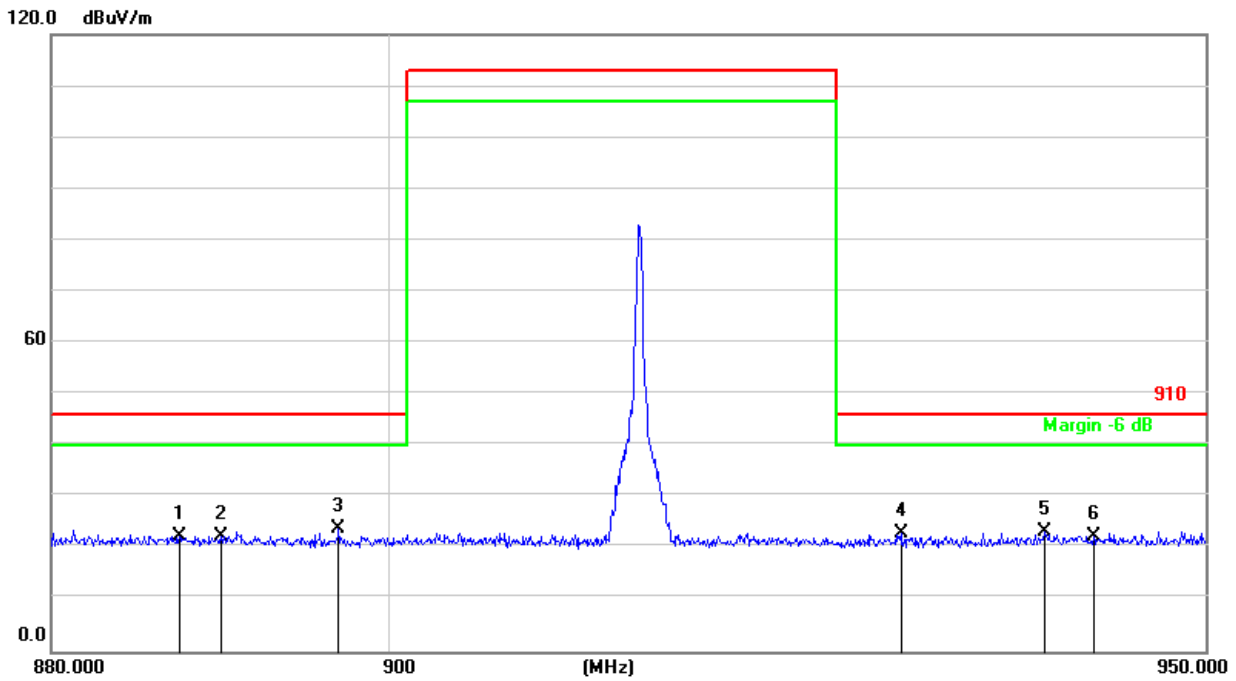

No.	Mk.	Freq. MHz	Reading Level dBuV	Correct Factor dB	Measure- ment dBuV/m	Limit dB/m	Over dB	Detector
1		887.5598	24.12	-1.75	22.37	46.00	-23.63	peak
2		890.0100	24.17	-1.70	22.47	46.00	-23.53	peak
3	*	896.9400	25.46	-1.56	23.90	46.00	-22.10	peak
4		931.0300	24.33	-1.26	23.07	46.00	-22.93	peak
5		939.9900	24.37	-1.19	23.18	46.00	-22.82	peak
6		943.0000	23.66	-1.16	22.50	46.00	-23.50	peak

Temperature:	26 °C	Relative Humidity:	54%
Pressure:	101 kPa	Test Voltage :	AC120V/60Hz
Test Mode :	Mode 3		

925MHz Horizontal

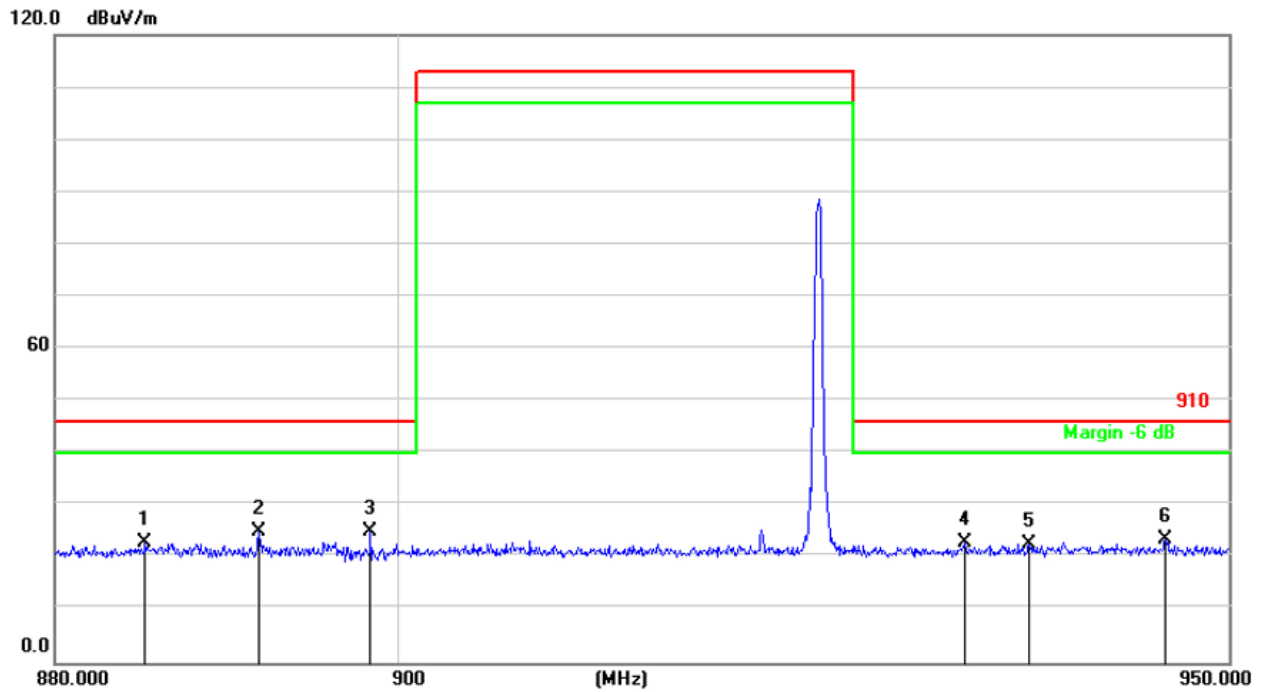

No.	Mk.	Freq. MHz	Reading Level dBuV	Correct Factor dB	Measure- ment dBuV/m	Limit dB/m	Over dB	Detector
1		885.2500	24.81	-1.80	23.01	46.00	-22.99	peak
2	*	891.8300	26.81	-1.67	25.14	46.00	-20.86	Peak
3		898.3400	26.55	-1.53	25.02	46.00	-20.98	Peak
4		933.8300	24.26	-1.24	23.02	46.00	-22.98	Peak
5		937.7500	23.98	-1.21	22.77	46.00	-23.23	peak
6		946.1500	24.71	-1.14	23.57	46.00	-22.43	Peak

925MHz Vertical

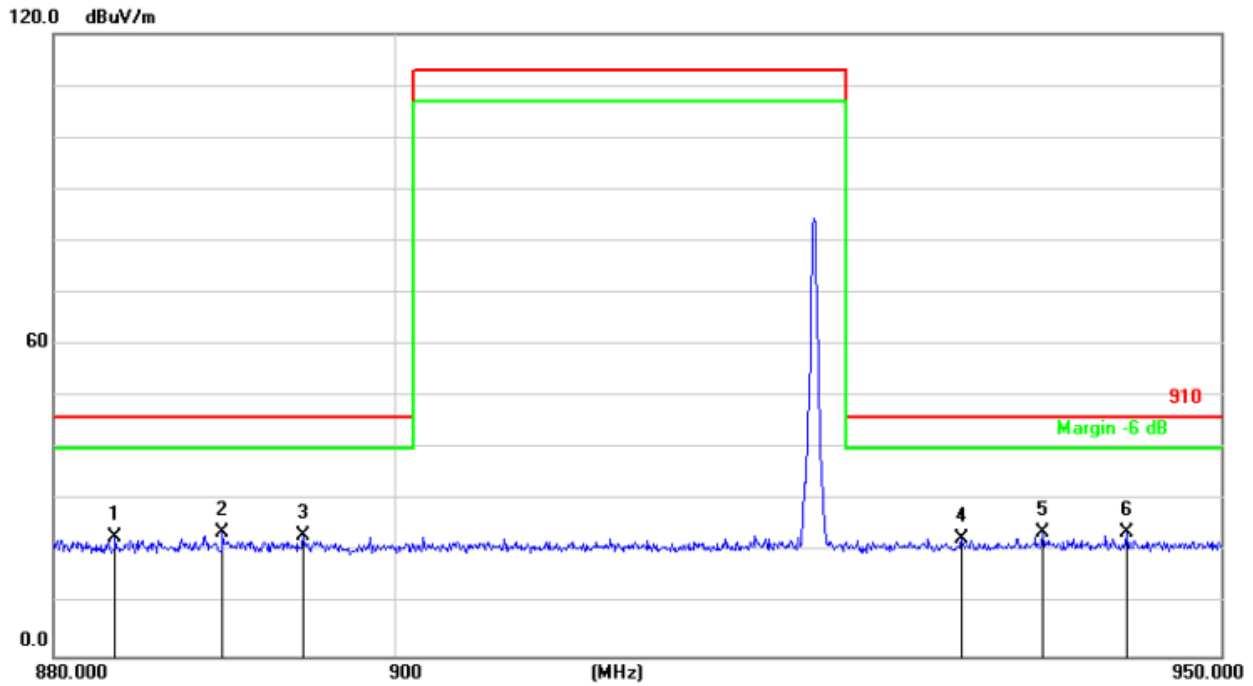

No.	Mk.	Freq. MHz	Reading Level dBuV	Correct Factor dB	Measure- ment dBuV/m	Limit dB/m	Over dB	Detector
1		883.6399	24.85	-1.83	23.02	46.00	-22.98	Peak
2		889.8700	25.52	-1.71	23.81	46.00	-22.19	Peak
3		894.5599	24.73	-1.61	23.12	46.00	-22.88	Peak
4		934.0399	23.82	-1.23	22.59	46.00	-23.41	Peak
5	*	938.9400	25.13	-1.20	23.93	46.00	-22.07	Peak
6		944.1900	24.98	-1.16	23.82	46.00	-22.18	Peak

8. 20 DB BANDWIDTH

8.1 Block Diagram Of Test Setup



8.2 Limit

FCC Part15 (15.249) , Subpart C			
Section	Test Item	Frequency Range (MHz)	Result
15.249	Bandwidth	902~928	PASS

8.3 Test procedure

1. Set resolution bandwidth (RBW) = 1-5% or DTS BW, not to exceed 100 kHz.
2. Set the video bandwidth (VBW) $\geq 3 \times$ RBW.
3. Detector = Peak.
4. Trace mode = max hold.
5. Sweep = auto couple.
6. Allow the trace to stabilize.
7. Measure the maximum width of the emission that is constrained by the frequencies associated with the two outermost amplitude points (upper and lower) that are attenuated by 20 dB relative to the maximum level measured in the fundamental emission.

8.4 EUT OPERATION CONDITIONS

The EUT tested system was configured as the statements of 2.4 Unless otherwise a special operating condition is specified in the follows during the testing.

8.5 Test Result

Temperature :	26°C	Relative Humidity :	54%
Test Voltage :	DC 5V	Remark	N/A

Channel	Frequency (MHz)	20dB bandwidth (KHz)
01	905	141.4
02	915	141.0
03	925	133.9

CH01



CH02

CH03



9. ANTENNA REQUIREMENT

9.1 Limit

15.203 requirement: For intentional device, according to 15.203: an intentional radiator shall be designed to ensure that no antenna other than that furnished by the responsible party shall be used with the device.

9.2 Test Result

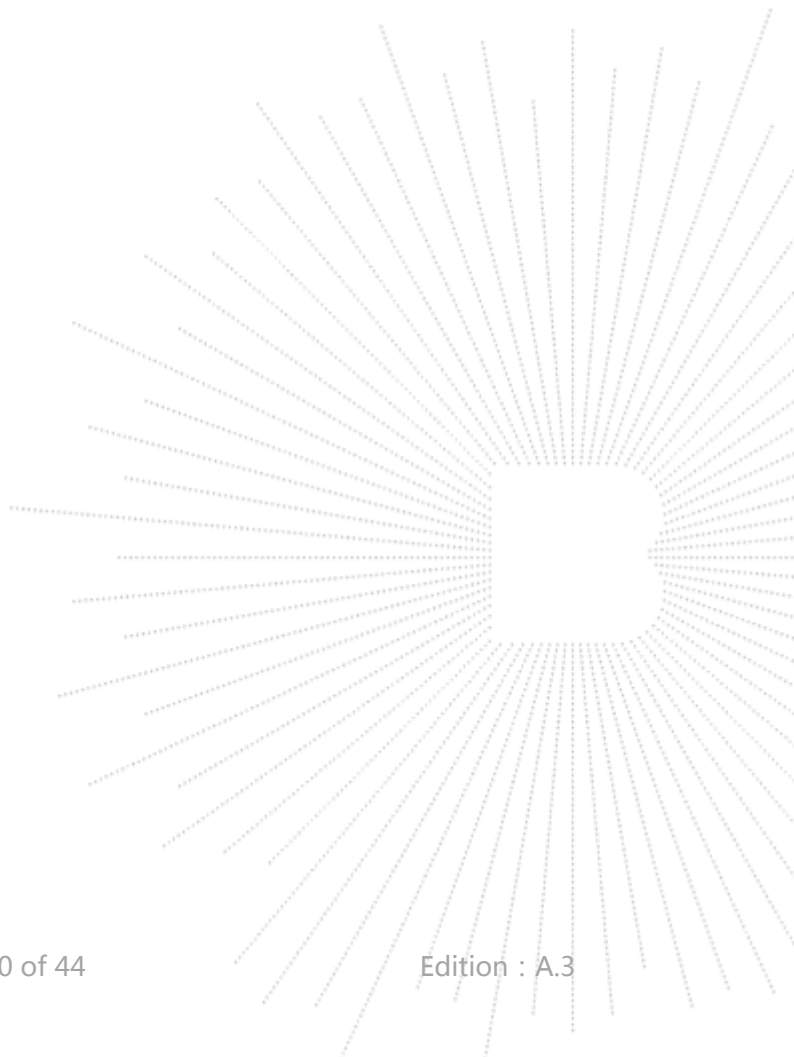
The EUT antenna is Internal antenna, The antenna gain is 0dBi, fulfill the requirement of this section.



10. EUT PHOTOGRAPHS

EUT Photo 1



EUT Photo 2



11. EUT TEST SETUP PHOTOGRAPHS

Conducted emissions



Radiated emissions





STATEMENT

- 1.The equipment lists are traceable to the national reference standards.
- 2.The test report can not be partially copied unless prior written approval is issued from our lab.
- 3.The test report is invalid without stamp of laboratory.
- 4.The test report is invalid without signature of person(s) testing and authorizing.
- 5.The test process and test result is only related to the Unit Under Test.
- 6.The quality system of our laboratory is in accordance with ISO/IEC17025.
- 7.If there is any objection to report, the client should inform issuing laboratory within 15 days from the date of receiving test report.

Address:

1-2/F., Building B, Pengzhou Industrial Park, No.158, Fuyuan 1st Road, Tangwei, Fuhai Subdistrict, Bao'an District, Shenzhen, Guangdong, China

TEL : 400-788-9558

P.C.: 518103

FAX : 0755-33229357

Website : <http://www.chnbctc.com>

E-Mail : bctc@bctc-lab.com.cn

***** END *****

