



Shenzhen Huaxia Testing Technology Co., Ltd

1F., Block A of Tongsheng Technology Building, Huahui Road, Dalang Street, Longhua District, Shenzhen, China

Telephone: +86-755-26648640
Fax: +86-755-26648637
Website: www.cqa-cert.com

Report Template Version: V04
Report Template Revision Date: 2018-07-06

Test Report

Report No.: CQASZ20200800807E-01
Applicant: Shenzhen HCY Electrics and Technology Co., Ltd
Address of Applicant: 5th Floor, Block 8, Shangxiawei Industrial Park, Shasan Road, Shajing, Shenzhen, China
Equipment Under Test (EUT):
EUT Name: Intelligent remote control
Model No.: CHY-Q40
Brand Name: N/A
FCC ID: 2AOBUHCY-Q40
Standards: 47 CFR Part 15, Subpart C
Date of Receipt: 2020-08-06
Date of Test: 2020-08-06 to 2020-08-18
Date of Issue: 2020-08-19
Test Result: **PASS***

*In the configuration tested, the EUT complied with the standards specified above

Tested By: Tiny You

(Tiny You)

Reviewed By: Sheek Luo

(Sheek Luo)

Approved By: Jack Ai

(Jack Ai)



1 Version

Revision History Of Report

Report No.	Version	Description	Issue Date
CQASZ20200800807E-01	Rev.01	Initial report	2020-08-19

2 Test Summary

Test Item	Test Requirement	Test method	Result
Antenna Requirement	47 CFR Part 15, Subpart C Section 15.203	ANSI C63.10 (2013)	PASS
AC Power Line Conducted Emission	47 CFR Part 15, Subpart C Section 15.207	ANSI C63.10 (2013)	PASS
Field Strength of the Fundamental Signal	47 CFR Part 15, Subpart C Section 15.249 (a)	ANSI C63.10 (2013)	PASS
Spurious Emissions	47 CFR Part 15, Subpart C Section 15.249 (a)/15.209	ANSI C63.10 (2013)	PASS
Restricted bands around fundamental frequency (Radiated Emission)	47 CFR Part 15, Subpart C Section 15.249(a)/15.205	ANSI C63.10 (2013)	PASS
20dB Occupied Bandwidth	47 CFR Part 15, Subpart C Section 15.215 (c)	ANSI C63.10 (2013)	PASS

3 Contents

	Page
1 VERSION	2
2 TEST SUMMARY	3
3 CONTENTS	4
4 GENERAL INFORMATION	5
4.1 CLIENT INFORMATION	5
4.2 GENERAL DESCRIPTION OF EUT	5
4.3 TEST ENVIRONMENT AND MODE	7
4.4 DESCRIPTION OF SUPPORT UNITS	7
4.5 STATEMENT OF THE MEASUREMENT UNCERTAINTY	8
4.6 TEST LOCATION	9
4.7 TEST FACILITY	9
4.8 DEVIATION FROM STANDARDS	9
4.9 ABNORMALITIES FROM STANDARD CONDITIONS	9
4.10 OTHER INFORMATION REQUESTED BY THE CUSTOMER	9
4.11 EQUIPMENT LIST	10
5 TEST RESULTS AND MEASUREMENT DATA	11
5.1 ANTENNA REQUIREMENT	11
5.2 CONDUCTED EMISSIONS	12
5.3 RADIATED EMISSION	15
5.4 20DB BANDWIDTH	23
6 PHOTOGRAPHS	26
6.1 RADIATED EMISSION TEST SETUP	26
6.2 CONDUCTED EMISSION TEST SETUP	27
6.3 EUT CONSTRUCTIONAL DETAILS	28

4 General Information

4.1 Client Information

Applicant:	Shenzhen HCY Electrics and Technology Co.,Ltd
Address of Applicant:	5th Floor, Block 8, Shangxiawei Industrial Park, Shasan Road, Shajing, Shenzhen, China
Manufacturer:	Shenzhen HCY Electrics and Technology Co.,Ltd
Address of Manufacturer:	5th Floor, Block 8, Shangxiawei Industrial Park, Shasan Road, Shajing, Shenzhen, China
Factory:	Shenzhen HCY Electrics and Technology Co.,Ltd
Address of Factory:	5th Floor, Block 8, Shangxiawei Industrial Park, Shasan Road, Shajing, Shenzhen, China

4.2 General Description of EUT

Product Name:	Intelligent remote control
Model No.:	CHY-Q40
Trade Mark:	N/A
Hardware Version:	HCYQ40-TX001-V12
Software Version:	hcy_q40_rc1163__18431751_v1.0
Frequency Range:	2404MHz ~ 2480MHz
Modulation Type:	GFSK
Number of Channels:	65 (declared by the client)
Sample Type:	<input type="checkbox"/> Mobile <input checked="" type="checkbox"/> Portable <input type="checkbox"/> Fix Location
Test Software of EUT:	RF test (manufacturer declare)
Antenna Type:	PCB antenna
Antenna Gain:	-3.0dBi
Power Supply:	lithium battery:DC3.7V, 550mAh, Charge by DC5.0V

Operation Frequency each of channel							
Channel	Frequency	Channel	Frequency	Channel	Frequency	Channel	Frequency
1	2404MHz	18	2424MHz	35	2444MHz	52	2467MHz
2	2405MHz	19	2425MHz	36	2445MHz	53	2468MHz
3	2406MHz	20	2426MHz	37	2446MHz	54	2469MHz
4	2407MHz	21	2427MHz	38	2450MHz	55	2470MHz
5	2408MHz	22	2428MHz	39	2451MHz	56	2471MHz
6	2409MHz	23	2429MHz	40	2452MHz	57	2472MHz
7	2410MHz	24	2430MHz	41	2453MHz	58	2473MHz
8	2411MHz	25	2434MHz	42	2454MHz	59	2474MHz
9	2412MHz	26	2435MHz	43	2455MHz	60	2475MHz
10	2413MHz	27	2436MHz	44	2456MHz	61	2476MHz
11	2414MHz	28	2437MHz	45	2457MHz	62	2477MHz
12	2418MHz	29	2438MHz	46	2458MHz	63	2478MHz
13	2419MHz	30	2439MHz	47	2459MHz	64	2479MHz
14	2420MHz	31	2440MHz	48	2460MHz	65	2480MHz
15	2421MHz	32	2441MHz	49	2461MHz		
16	2422MHz	33	2442MHz	50	2462MHz		
17	2423MHz	34	2443MHz	51	2466MHz		

Note:

In section 15.31(m), regards to the operating frequency range over 10 MHz, the Lowest frequency, the middle frequency, and the highest frequency of channel were selected to perform the test, and the selected channel see below:

Channel	Frequency
The Lowest channel(CH1)	2404MHz
The Middle channel(CH31)	2440MHz
The Highest channel(CH65)	2480MHz

4.3 Test Environment and Mode

Operating Environment:	
Radiated Emissions:	
Temperature:	25.6 °C
Humidity:	56 % RH
Atmospheric Pressure:	1009mbar
Conduction emission:	
Temperature:	25.8 °C
Humidity:	57 % RH
Atmospheric Pressure:	1009mbar
Radio conducted item test (RF Conducted test room):	
Temperature:	25.1 °C
Humidity:	52 % RH
Atmospheric Pressure:	1009mbar
Test mode:	
Transmitting mode:	Use test software (RF test) to set the lowest frequency, the middle frequency and the highest frequency keep transmitting of the EUT.

4.4 Description of Support Units

The EUT has been tested with associated equipment below.

1) Support equipment

Description	Manufacturer	Model No.	Certification	Supplied by
Adapter	HUAWEI	LPL-C010050200Z	DOC	CQA

2) Cable

Cable No.	Description	Manufacturer	Cable Type/Length	Supplied by
/	/	/	/	/

4.5 Statement of the measurement uncertainty

The data and results referenced in this document are true and accurate.

The reader is cautioned that there may be errors within the calibration limits of the equipment and facilities.

The measurement uncertainty was calculated for all measurements listed in this test report acc. to CISPR 16 - 4 „Specification for radio disturbance and immunity measuring apparatus and methods – Part 4: Uncertainty in EMC Measurements“ and is documented in the **Shenzhen Huaxia Testing Technology Co., Ltd** quality system acc. to DIN EN ISO/IEC 17025.

Furthermore, component and process variability of devices similar to that tested may result in additional deviation. The manufacturer has the sole responsibility of continued compliance of the device.

Hereafter the best measurement capability for **CQA** laboratory is reported:

Test	Range	Uncertainty	Notes
Radiated Emission	Below 1GHz	5.12dB	(1)
Radiated Emission	Above 1GHz	4.60dB	(1)
Conducted Disturbance	0.15~30MHz	3.34dB	(1)

(1) This uncertainty represents an expanded uncertainty expressed at approximately the 95% confidence level using a coverage factor of $k=2$.

4.6 Test Location

All tests were performed at:

Shenzhen Huaxia Testing Technology Co., Ltd.,

1F., Block A of Tongsheng Technology Building, Huahui Road, Dalang Street, Longhua District, Shenzhen, China

4.7 Test Facility

- **A2LA (Certificate No. 4742.01)**

Shenzhen Huaxia Testing Technology Co., Ltd., Shenzhen EMC Laboratory is accredited by the American Association for Laboratory Accreditation(A2LA). Certificate No. 4742.01.

- **FCC Registration No.: 522263**

Shenzhen Huaxia Testing Technology Co., Ltd., Shenzhen EMC Laboratory has been registered and fully described in a report filed with the (FCC) Federal Communications Commission. The acceptance letter from the FCC is maintained in our files. Registration No.:522263

4.8 Deviation from Standards

None.

4.9 Abnormalities from Standard Conditions

None.

4.10 Other Information Requested by the Customer

None.

4.11 Equipment List

Test Equipment	Manufacturer	Model No.	Instrument No.	Calibration Date	Calibration Due Date
EMI Test Receiver	R&S	ESR7	CQA-005	2019/10/25	2020/10/24
Spectrum analyzer	R&S	FSU26	CQA-038	2019/10/25	2020/10/24
Preamplifier	MITEQ	AMF-6D-02001800-29-20P	CQA-036	2019/10/25	2020/10/24
Loop antenna	Schwarzbeck	FMZB1516	CQA-060	2019/10/21	2020/10/20
Bilog Antenna	R&S	HL562	CQA-011	2019/9/26	2020/9/25
Horn Antenna	R&S	HF906	CQA-012	2019/9/26	2020/9/25
Horn Antenna	Schwarzbeck	BBHA 9170	CQA-088	2019/9/25	2020/9/24
Coaxial Cable (Above 1GHz)	CQA	N/A	C007	2019/9/26	2020/9/25
Coaxial Cable (Below 1GHz)	CQA	N/A	C013	2019/9/26	2020/9/25
Antenna Connector	CQA	RFC-01	CQA-080	2019/9/26	2020/9/25
RF cable(9KHz~40GHz)	CQA	RF-01	CQA-079	2019/9/26	2020/9/25
Power divider	MIDWEST	PWD-2533-02-SMA-79	CQA-067	2019/9/26	2020/9/25
EMI Test Receiver	R&S	ESR7	CQA-005	2019/10/25	2020/10/24
LISN	R&S	ENV216	CQA-003	2019/10/23	2020/10/22
Coaxial cable	CQA	N/A	CQA-C009	2019/9/26	2020/9/25
DC power	KEYSIGHT	E3631A	CQA-028	2019/9/26	2020/9/25

Note:

The temporary antenna connector is soldered on the PCB board in order to perform conducted tests and this temporary antenna connector is listed in the equipment list.

5 Test results and Measurement Data

5.1 Antenna Requirement

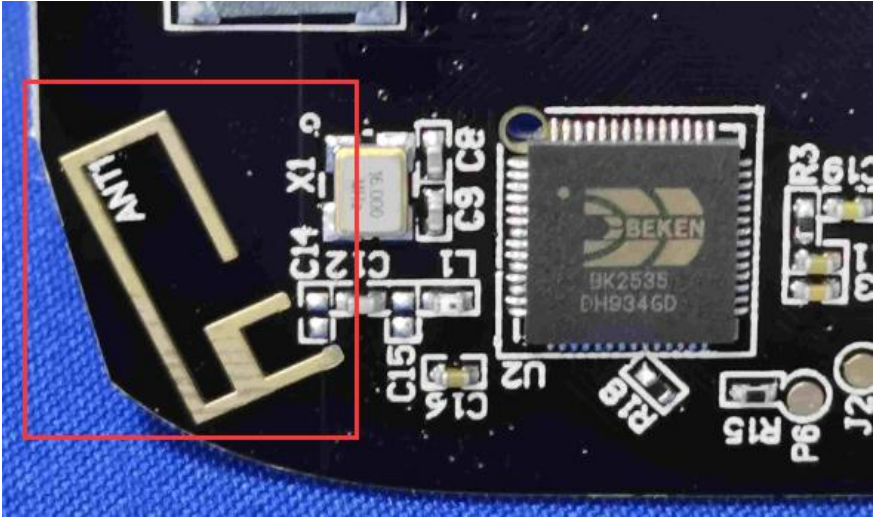
Standard requirement:	47 CFR Part 15C Section 15.203
<p>15.203 requirement: An intentional radiator shall be designed to ensure that no antenna other than that furnished by the responsible party shall be used with the device. The use of a permanently attached antenna or of an antenna that uses a unique coupling to the intentional radiator, the manufacturer may design the unit so that a broken antenna can be replaced by the user, but the use of a standard antenna jack or electrical connector is prohibited.</p>	
EUT Antenna:	
<p>The antenna is PCB antenna. The best case gain of the antenna is -3.0dBi.</p>	

5.2 Conducted Emissions

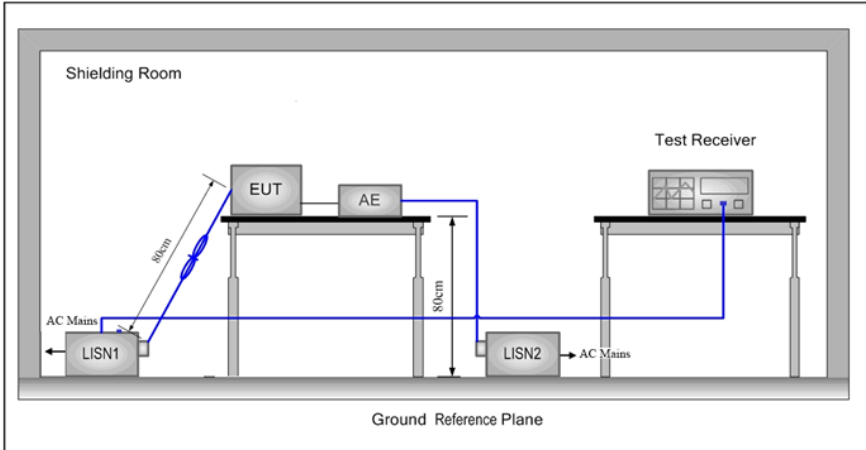
Test Requirement:	47 CFR Part 15C Section 15.207		
Test Method:	ANSI C63.10: 2013		
Test Frequency Range:	150kHz to 30MHz		
Limit:	Frequency range (MHz)	Limit (dBuV)	
		Quasi-peak	Average
	0.15-0.5	66 to 56*	56 to 46*
	0.5-5	56	46
	5-30	60	50
* Decreases with the logarithm of the frequency.			
Test Procedure:	<ol style="list-style-type: none"> 1) The mains terminal disturbance voltage test was conducted in a shielded room. 2) The EUT was connected to AC power source through a LISN 1 (Line Impedance Stabilization Network) which provides a $50\Omega/50\mu\text{H} + 5\Omega$ linear impedance. The power cables of all other units of the EUT were connected to a second LISN 2, which was bonded to the ground reference plane in the same way as the LISN 1 for the unit being measured. A multiple socket outlet strip was used to connect multiple power cables to a single LISN provided the rating of the LISN was not exceeded. 3) The tabletop EUT was placed upon a non-metallic table 0.8m above the ground reference plane. And for floor-standing arrangement, the EUT was placed on the horizontal ground reference plane. 4) The test was performed with a vertical ground reference plane. The rear of the EUT shall be 0.4 m from the vertical ground reference plane. The vertical ground reference plane was bonded to the horizontal ground reference plane. The LISN 1 was placed 0.8 m from the boundary of the unit under test and bonded to a ground reference plane for LISNs mounted on top of the ground reference plane. This distance was between the closest points of the LISN 1 and the EUT. All other units of the EUT and associated equipment was at least 0.8 m from the LISN 2. 5) In order to find the maximum emission, the relative positions of equipment and all of the interface cables must be changed according to ANSI C63.10: 2013 on conducted measurement. 		
Test Setup:			

Test Mode:	Transmitting with GFSK modulation. Charge +Transmitting mode.
Final Test Mode:	below 1GHz part, through pre-scan, the worst case is the lowest channel. Only the worst case is recorded in the report.
Test Results:	Pass

Measurement Data

Live line:

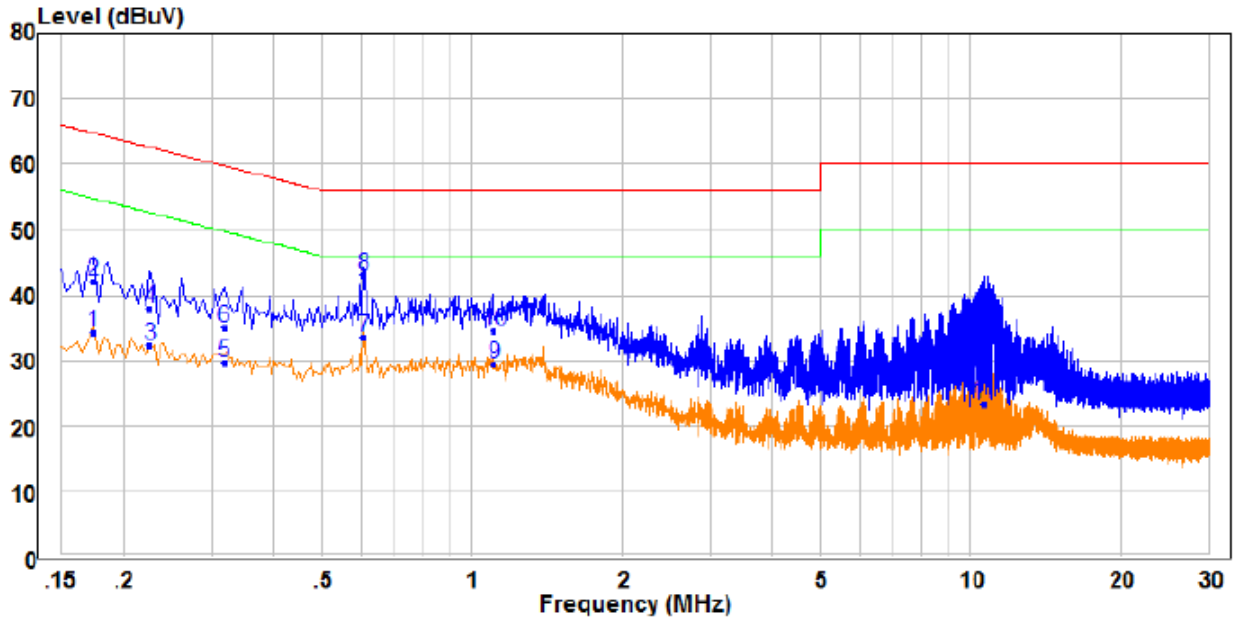

	Freq	Read Level	Factor	Limit Level	Over Limit	Remark	Pol/Phase	
	MHz	dBuV	dB	dBuV	dB			
1	0.174	24.78	9.49	34.27	54.77	-20.50	Average	Line
2	0.174	32.50	9.49	41.99	64.77	-22.78	QP	Line
3	0.226	22.93	9.49	32.42	52.60	-20.18	Average	Line
4	0.226	28.45	9.49	37.94	62.60	-24.66	QP	Line
5	0.318	20.20	9.49	29.69	49.76	-20.07	Average	Line
6	0.318	25.42	9.49	34.91	59.76	-24.85	QP	Line
7	0.606	23.87	9.72	33.59	46.00	-12.41	Average	Line
8	0.606	33.35	9.72	43.07	56.00	-12.93	QP	Line
9	1.106	19.91	9.53	29.44	46.00	-16.56	Average	Line
10	1.106	24.90	9.53	34.43	56.00	-21.57	QP	Line
11	10.649	13.58	9.82	23.40	50.00	-26.60	Average	Line
12	10.649	26.41	9.82	36.23	60.00	-23.77	QP	Line

Remark:

1. The following Quasi-Peak and Average measurements were performed on the EUT:
2. Final Test Level = Receiver Reading + LISN Factor + Cable Loss.
3. If the Peak value under Average limit, the Average value is not recorded in the report.

Neutral line:

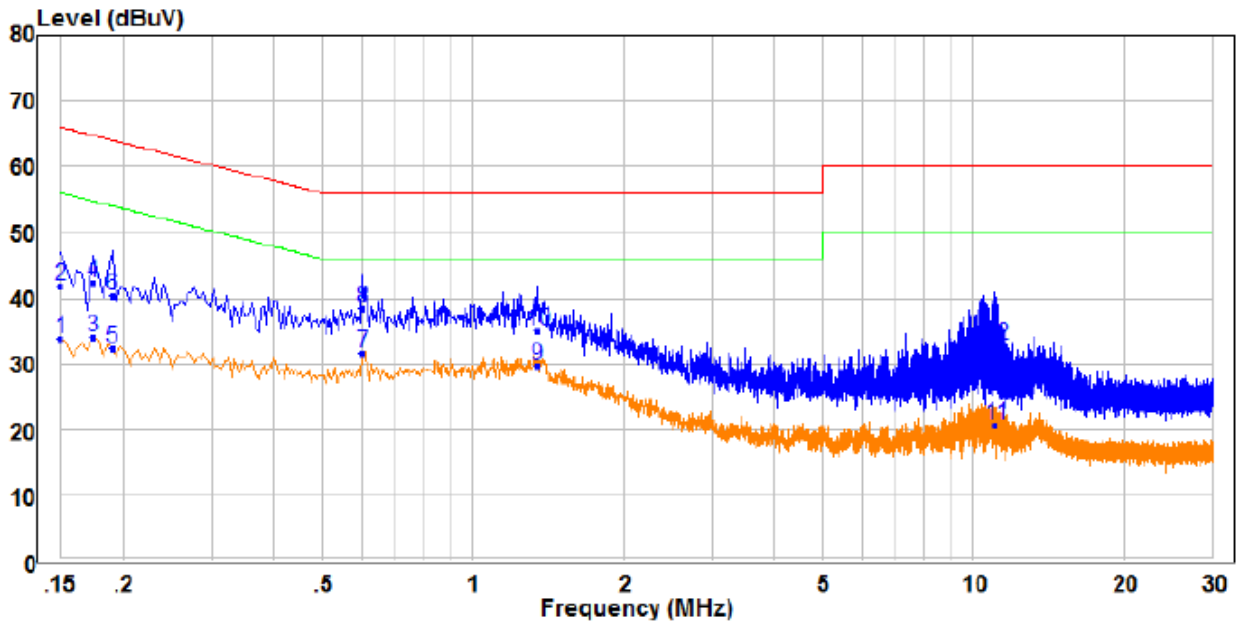

	Freq	Read Level	Factor	Level	Limit Line	Over Limit	Remark	Pol/Phase
	MHz	dBuV	dB	dBuV	dBuV	dB		
1	0.150	24.32	9.48	33.80	56.00	-22.20	Average	Neutral
2	0.150	32.31	9.48	41.79	66.00	-24.21	QP	Neutral
3	0.174	24.68	9.48	34.16	54.77	-20.61	Average	Neutral
4	0.174	32.73	9.48	42.21	64.77	-22.56	QP	Neutral
5	0.190	22.88	9.48	32.36	54.04	-21.68	Average	Neutral
6	0.190	30.83	9.48	40.31	64.04	-23.73	QP	Neutral
7 PP	0.602	21.88	9.71	31.59	46.00	-14.41	Average	Neutral
8 QP	0.602	28.80	9.71	38.51	56.00	-17.49	QP	Neutral
9	1.346	19.99	9.72	29.71	46.00	-16.29	Average	Neutral
10	1.346	25.24	9.72	34.96	56.00	-21.04	QP	Neutral
11	11.097	10.67	9.94	20.61	50.00	-29.39	Average	Neutral
12	11.097	22.97	9.94	32.91	60.00	-27.09	QP	Neutral

Remark:

1. The following Quasi-Peak and Average measurements were performed on the EUT:
2. Final Test Level = Receiver Reading + LISN Factor + Cable Loss.
3. If the Peak value under Average limit, the Average value is not recorded in the report.

5.3 Radiated Emission

Test Requirement:	47 CFR Part 15C Section 15.249 and 15.209 and 15.205				
Test Method:	ANSI C63.10: 2013				
Test Site:	Measurement Distance: 3m (Semi-Anechoic Chamber)				
Receiver Setup:	Frequency	Detector	RBW	VBW	Remark
	0.009MHz-0.090MHz	Peak	10kHz	30KHz	Peak
	0.009MHz-0.090MHz	Average	10kHz	30KHz	Average
	0.090MHz-0.110MHz	Quasi-peak	10kHz	30KHz	Quasi-peak
	0.110MHz-0.490MHz	Peak	10kHz	30KHz	Peak
	0.110MHz-0.490MHz	Average	10kHz	30KHz	Average
	0.490MHz-30MHz	Quasi-peak	10kHz	30kHz	Quasi-peak
	30MHz-1GHz	Quasi-peak	100 kHz	300KHz	Quasi-peak
	Above 1GHz	Peak	1MHz	3MHz	Peak
		Peak	1MHz	10Hz	Average
Note: For fundamental frequency, RBW=5MHz, VBW=5MHz, Peak detector is for PK value, RMS detector is for Average value.					
Limit: (Spurious Emissions and band edge)	Frequency	Field strength (microvolt/meter)	Limit (dBuV/m)	Remark	Measurement distance (m)
	0.009MHz-0.490MHz	2400/F(kHz)	-	-	300
	0.490MHz-1.705MHz	24000/F(kHz)	-	-	30
	1.705MHz-30MHz	30	-	-	30
	30MHz-88MHz	100	40.0	Quasi-peak	3
	88MHz-216MHz	150	43.5	Quasi-peak	3
	216MHz-960MHz	200	46.0	Quasi-peak	3
	960MHz-1GHz	500	54.0	Quasi-peak	3
	Above 1GHz	500	54.0	Average	3
Note: 1) 15.35(b), Unless otherwise specified, the limit on peak radio frequency emissions is 20dB above the maximum permitted average emission limit applicable to the equipment under test. This peak limit applies to the total peak emission level radiated by the device. 2) Emissions radiated outside of the specified frequency bands, except for harmonics, shall be attenuated by at least 50 dB below the level of the fundamental or to the general radiated emission limits in Section 15.209, whichever is the lesser attenuation.					
Limit: (Field strength of the fundamental signal)	Frequency	Limit (dBuV/m @3m)		Remark	
	2400MHz-2483.5MHz	94.0		Average Value	
		114.0		Peak Value	

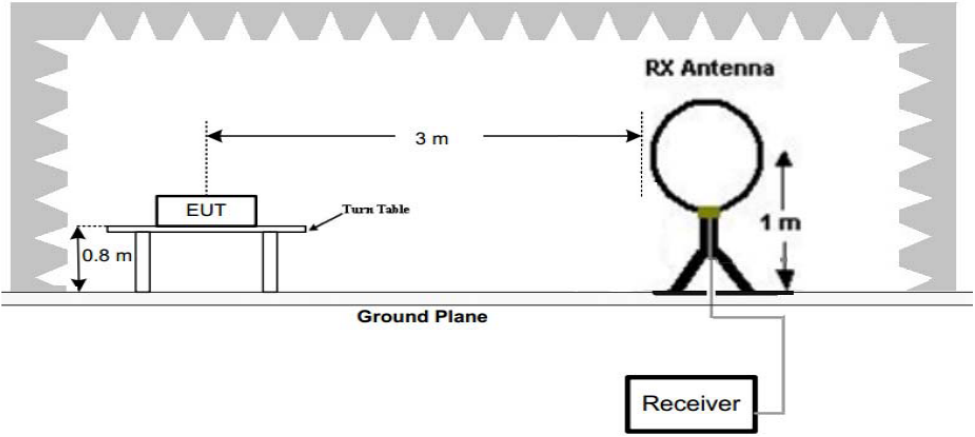
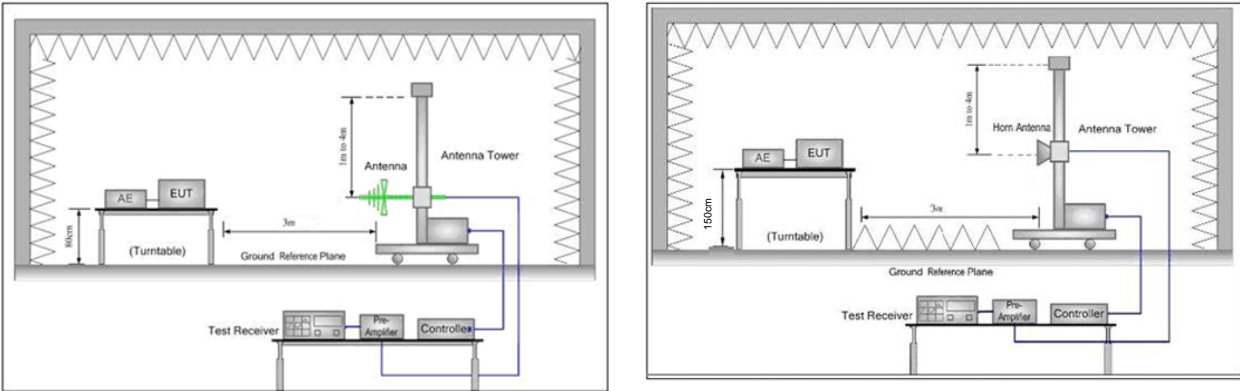
<p>Test Setup:</p>		
		
<p>Figure 1. Below 30MHz</p>		
		
<p>Figure 2. 30MHz to 1GHz</p>		<p>Figure 3. Above 1 GHz</p>
<p>Test Procedure:</p>	<p>a. 1) Below 1G: The EUT was placed on the top of a rotating table 0.8 meters above the ground at a 3 meter semi-anechoic chamber. The table was rotated 360 degrees to determine the position of the highest radiation. 2) Above 1G: The EUT was placed on the top of a rotating table 1.5 meters above the ground at a 3 meter semi-anechoic chamber. The table was rotated 360 degrees to determine the position of the highest radiation. Note: For the radiated emission test above 1GHz: Place the measurement antenna away from each area of the EUT determined to be a source of emissions at the specified measurement distance, while keeping the measurement antenna aimed at the source of emissions at each frequency of significant emissions, with polarization oriented for maximum response. The measurement antenna may have to be higher or lower than the EUT, depending on the radiation pattern of the emission and staying aimed at the emission source for receiving the maximum signal. The final measurement antenna elevation shall be that which maximizes the emissions. The measurement antenna elevation for maximum emissions shall be restricted to a range of heights of from 1 m to 4 m above the ground or reference ground plane.</p> <p>b. The EUT was set 3 meters away from the interference-receiving antenna, which was mounted on the top of a variable-height antenna tower.</p> <p>c. The antenna height is varied from one meter to four meters above the ground to determine the maximum value of the field strength. Both horizontal and vertical polarizations of the antenna are set to make the measurement.</p> <p>d. For each suspected emission, the EUT was arranged to its worst case and then the antenna was tuned to heights from 1 meter to 4 meters (for the test frequency of</p>	

	<p>below 30MHz, the antenna was tuned to heights 1 meter) and the rotatable table was turned from 0 degrees to 360 degrees to find the maximum reading.</p> <p>e. The test-receiver system was set to Peak Detect Function and Specified Bandwidth with Maximum Hold Mode.</p> <p>f. If the emission level of the EUT in peak mode was 10dB lower than the limit specified, then testing could be stopped and the peak values of the EUT would be reported. Otherwise the emissions that did not have 10dB margin would be re-tested one by one using peak, quasi-peak or average method as specified and then reported in a data sheet.</p> <p>g. Test the EUT in the lowest channel,the middle channel,the Highest channel</p> <p>h. The radiation measurements are performed in X, Y, Z axis positioning for Transmitting mode,And found the X axis positioning which it is worse case.</p> <p>i. Repeat above procedures until all frequencies measured was complete.</p>
Exploratory Test Mode:	Transmitting mode, Charge + Transmitting mode.
Final Test Mode:	<p>Pretest the EUT at Transmitting mode and Charge + Transmitting mode, found the Charge + Transmitting mode which it is worse case.</p> <p>For below 1GHz part, through pre-scan, the worst case is the lowest channel.</p> <p>Only the worst case is recorded in the report.</p>
Test Results:	Pass

Measurement Data

30MHz~1GHz		
Test mode:	Charging+Transmitting	Vertical

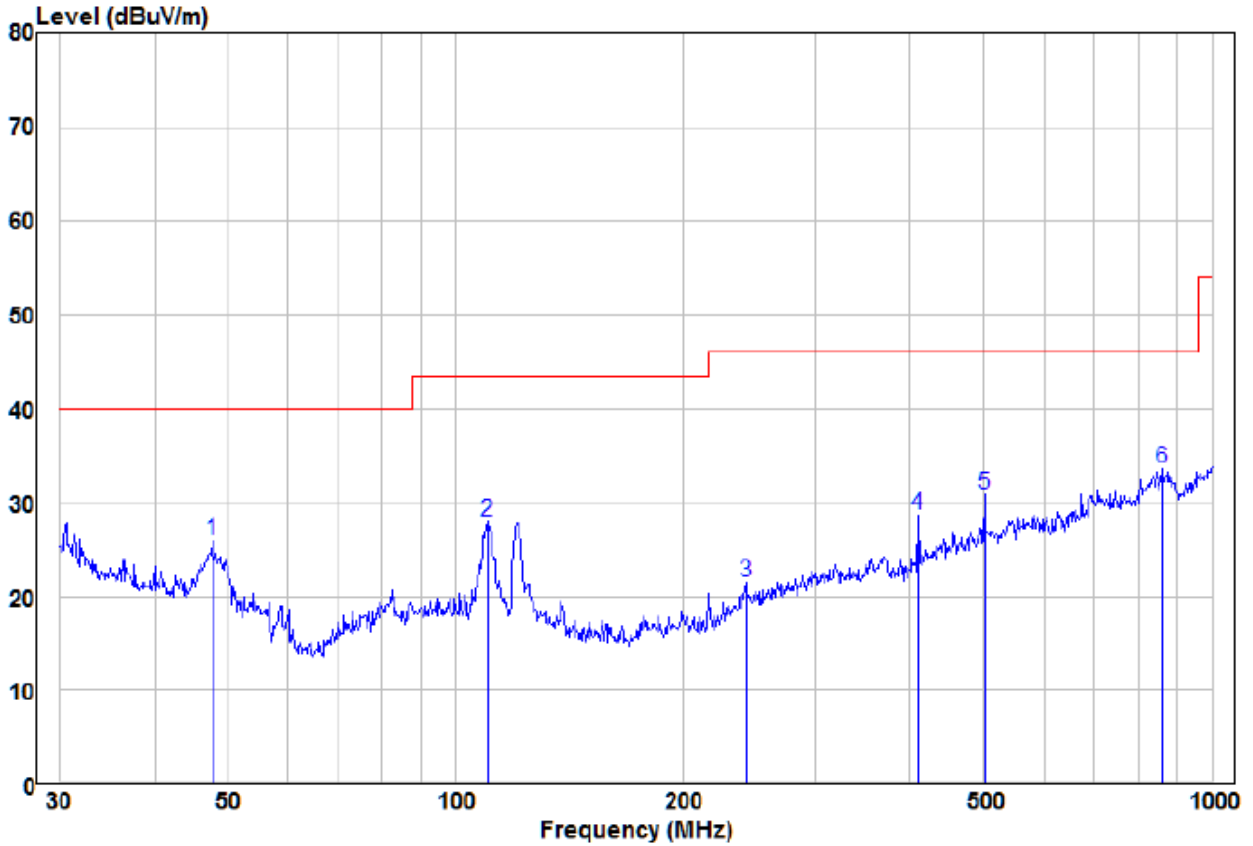

	Read Freq	Read Level	Read Factor	Limit Level	Limit Line	Over Limit	Remark	Pol/Phase
	MHz	dBuV	dB/m	dBuV/m	dBuV/m	dB		
1	47.66	16.73	9.19	25.92	40.00	-14.08	Peak	VERTICAL
2	110.57	17.73	10.21	27.94	43.50	-15.56	Peak	VERTICAL
3	242.53	9.78	11.74	21.52	46.00	-24.48	Peak	VERTICAL
4	408.95	13.15	15.43	28.58	46.00	-17.42	Peak	VERTICAL
5	501.18	12.66	18.29	30.95	46.00	-15.05	Peak	VERTICAL
6 pp	860.04	9.59	24.01	33.60	46.00	-12.40	Peak	VERTICAL

Test mode:	Charging+Transmitting	Horizontal
------------	-----------------------	------------

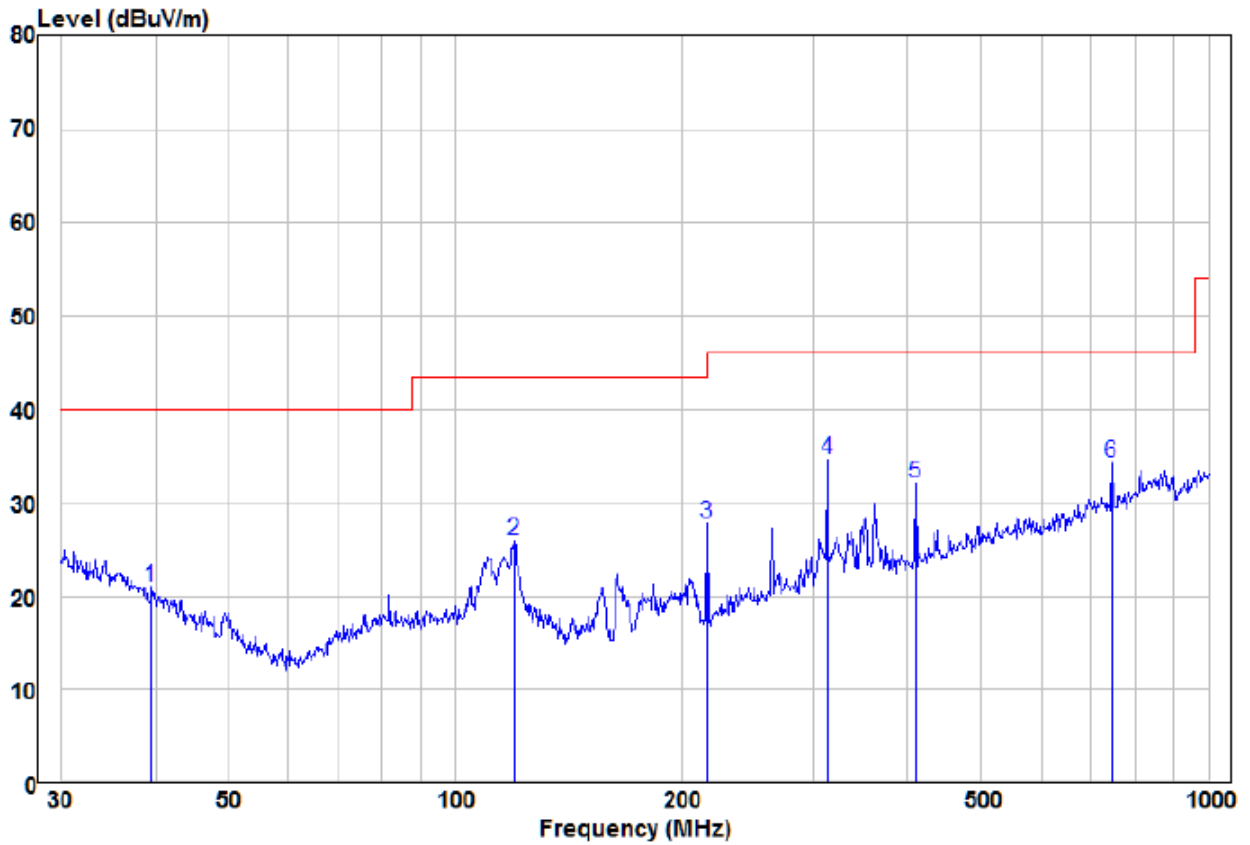

	Read Freq	Read Level	Factor	Limit Level	Over Limit	Remark	Pol/Phase
	MHz	dBuV	dB/m	dBuV/m	dBuV/m	dB	
1	39.58	8.11	12.95	21.06	40.00	-18.94	Peak HORIZONTAL
2	119.86	15.27	10.69	25.96	43.50	-17.54	Peak HORIZONTAL
3	216.02	18.89	9.00	27.89	46.00	-18.11	Peak HORIZONTAL
4 pp	312.18	20.58	14.03	34.61	46.00	-11.39	Peak HORIZONTAL
5	408.95	16.56	15.43	31.99	46.00	-14.01	Peak HORIZONTAL
6	744.87	12.37	21.88	34.25	46.00	-11.75	Peak HORIZONTAL

Above 1GHz							
Test mode:		Transmitting		Test channel:		Lowest	
Frequency	Meter Reading	Factor	Emission Level	Limits	Over	Detector Type	Ant. Pol.
(MHz)	(dB μ V)	(dB)	(dB μ V/m)	(dB μ V/m)	(dB)		H/V
2390	58.49	-9.2	49.29	74	-24.71	Peak	H
2390	44.83	-9.2	35.63	54	-18.37	AVG	H
2400	60.19	-9.39	50.80	74	-23.20	Peak	H
2400	46.31	-9.39	36.92	54	-17.08	AVG	H
2404	91.87	-9.36	82.51	114	-31.49	peak	H
2404	86.22	-9.36	76.86	94	-17.14	AVG	H
4808	53.88	-4.28	49.60	74	-24.40	peak	H
4808	37.51	-4.28	33.23	54	-20.77	AVG	H
7212	51.98	1.16	53.14	74	-20.86	peak	H
7212	37.72	1.16	38.88	54	-15.12	AVG	H
2390	58.87	-9.2	49.67	74	-24.33	peak	V
2390	44.92	-9.2	35.72	54	-18.28	AVG	V
2400	59.72	-9.39	50.33	74	-23.67	peak	V
2400	46.14	-9.39	36.75	54	-17.25	AVG	V
2404	91.66	-9.36	82.3	114	-31.7	peak	V
2404	85.97	-9.36	76.61	94	-17.39	AVG	V
4808	54.98	-4.28	50.70	74	-23.30	peak	V
4808	39.50	-4.28	35.22	54	-18.78	AVG	V
7212	50.83	1.16	51.99	74	-22.01	peak	V
7212	36.91	1.16	38.07	54	-15.93	AVG	V

Test mode:		Transmitting		Test channel:		Middle	
Frequency	Meter Reading	Factor	Emission Level	Limits	Over	Detector Type	Ant. Pol.
(MHz)	(dB μ V)	(dB)	(dB μ V/m)	(dB μ V/m)	(dB)		H/V
2440	92.86	-9.45	83.41	114	-30.59	peak	H
2440	87.12	-9.45	77.67	94	-16.33	AVG	H
4880	51.54	-4.11	47.43	74	-26.57	peak	H
4880	36.14	-4.11	32.03	54	-21.97	AVG	H
7320	48.45	1.51	49.96	74	-24.04	peak	H
7320	35.53	1.51	37.04	54	-16.96	AVG	H
2440	92.56	-9.45	83.11	114	-30.89	peak	V
2440	86.77	-9.45	77.32	94	-16.68	AVG	V
4880	52.64	-4.11	48.53	74	-25.47	peak	V
4880	36.80	-4.11	32.69	54	-21.31	AVG	V
7320	48.46	1.51	49.97	74	-24.03	peak	V
7320	36.34	1.51	37.85	54	-16.15	AVG	V

Test mode:		Transmitting		Test channel:		Highest	
Frequency	Meter Reading	Factor	Emission Level	Limits	Over	Detector Type	Ant. Pol.
(MHz)	(dBμV)	(dB)	(dBμV/m)	(dBμV/m)	(dB)		H/V
2480	91.67	-9.21	82.46	114	-31.54	peak	H
2480	85.34	-9.21	76.13	94	-17.87	AVG	H
2483.5	58.04	-9.29	48.75	74	-25.25	Peak	H
2483.5	43.49	-9.29	34.20	54	-19.80	AVG	H
4960	52.28	-4.04	48.24	74	-25.76	peak	H
4960	37.53	-4.04	33.49	54	-20.51	AVG	H
7440	50.14	1.57	51.71	74	-22.29	peak	H
7440	36.88	1.57	38.45	54	-15.55	AVG	H
2480	92.13	-9.21	82.92	114	-31.08	peak	V
2480	86.54	-9.21	77.33	94	-16.67	AVG	V
2483.5	58.38	-9.29	49.09	74	-24.91	peak	V
2483.5	45.98	-9.29	36.69	54	-17.31	AVG	V
4960	54.04	-4.04	50.00	74	-24.00	peak	V
4960	37.53	-4.04	33.49	54	-20.51	AVG	V
7440	50.28	1.57	51.85	74	-22.15	peak	V
7440	36.59	1.57	38.16	54	-15.84	AVG	V

Remark:

- 1) The field strength is calculated by adding the Antenna Factor, Cable Factor & Preamplifier. The basic equation with a sample calculation is as follows:
Final Test Level = Receiver Reading + Antenna Factor + Cable Factor – Preamplifier Factor
- 2) Scan from 9kHz to 25GHz, The disturbance above 10GHz and below 30MHz was very low, and the above harmonics were the highest point could be found when testing, so only the above harmonics had been displayed. The amplitude of spurious emissions from the radiator which are attenuated more than 20dB below the limit need not be reported .

5.4 20dB Bandwidth

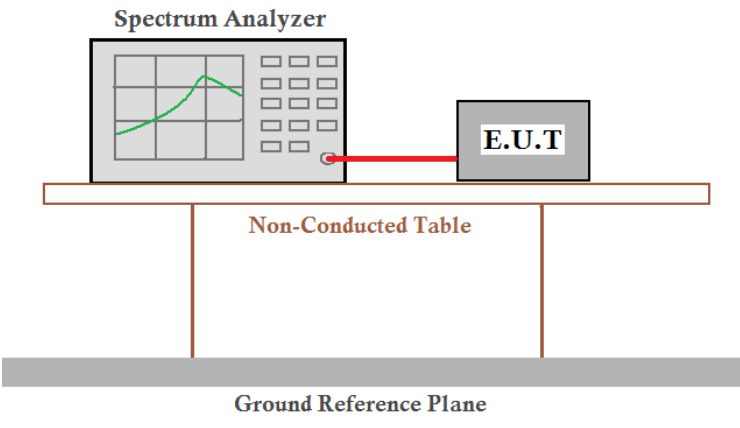
Test Requirement:	47 CFR Part 15C Section 15.215
Test Method:	ANSI C63.10:2013
Test Setup:	 <p>The diagram illustrates the test setup. A Spectrum Analyzer is connected to an E.U.T. (Equipment Under Test) via a red cable. Both are placed on a Non-Conducted Table, which is supported by a Ground Reference Plane.</p>
Test Mode:	Transmitting with GFSK modulation.
Limit:	N/A
Test Results:	Pass

Measurement Data

Test channel	20dB bandwidth (MHz)	Results
Lowest	0.875	Pass
Middle	0.87	Pass
Highest	0.88	Pass

Test plot as follows:

Test channel: Lowest

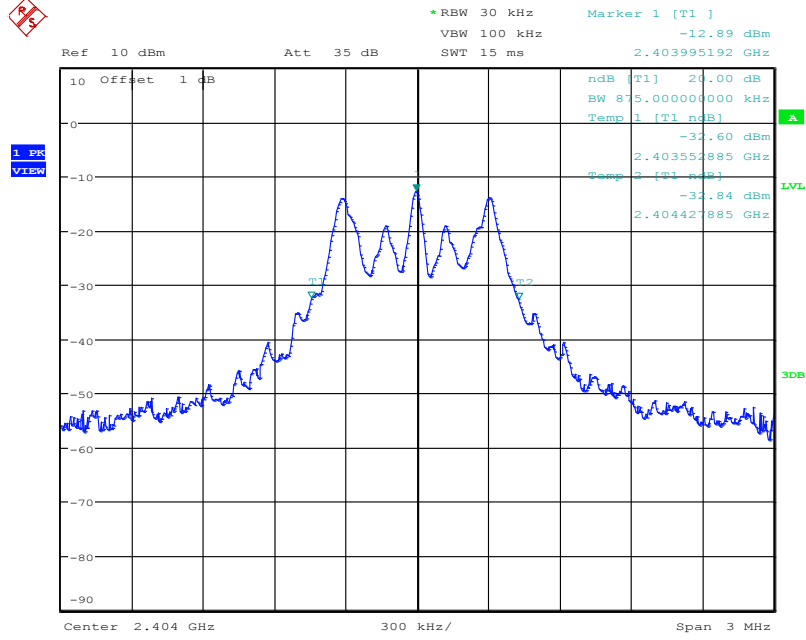

Date: 12.AUG.2020 09:11:15

Test channel: Middle

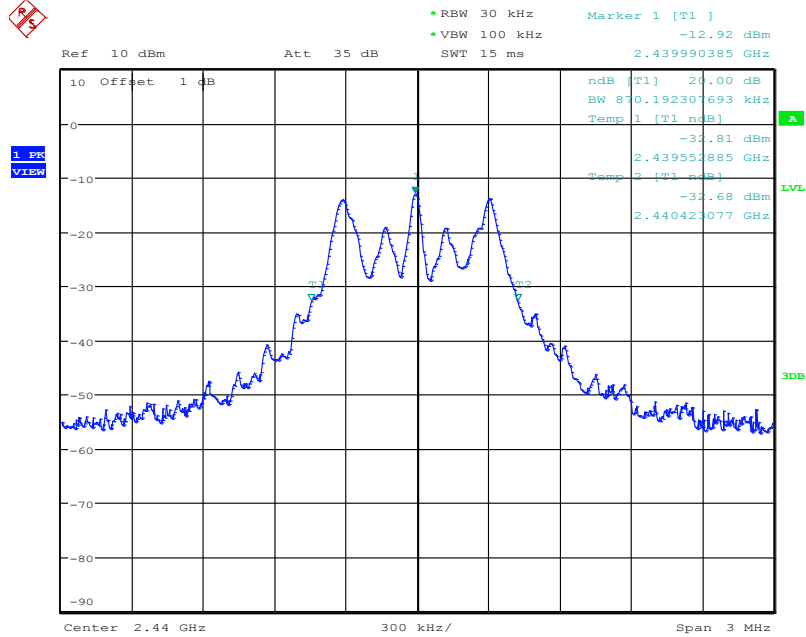

Date: 12.AUG.2020 09:15:59

Test channel: Highest

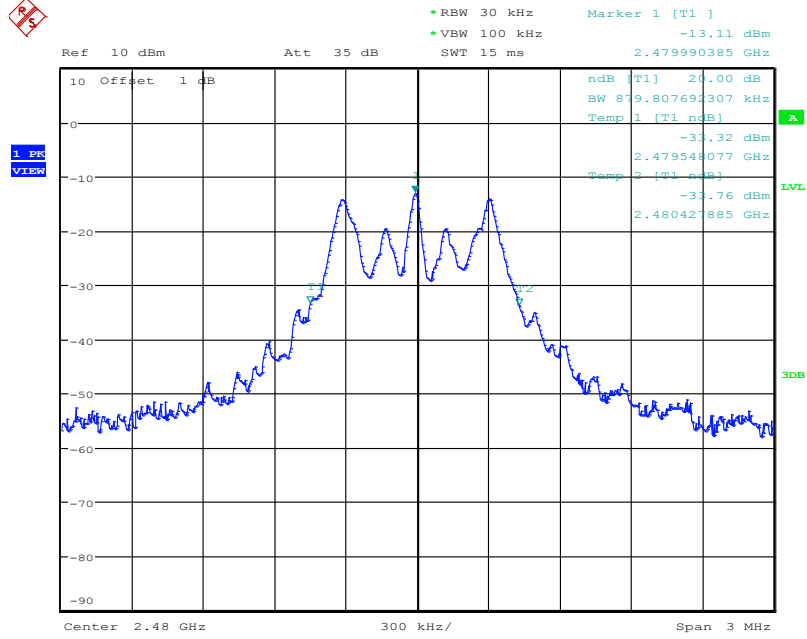

Date: 12.AUG.2020 09:19:47

6 Photographs

6.1 Radiated Emission Test Setup

9kHz~30MHz

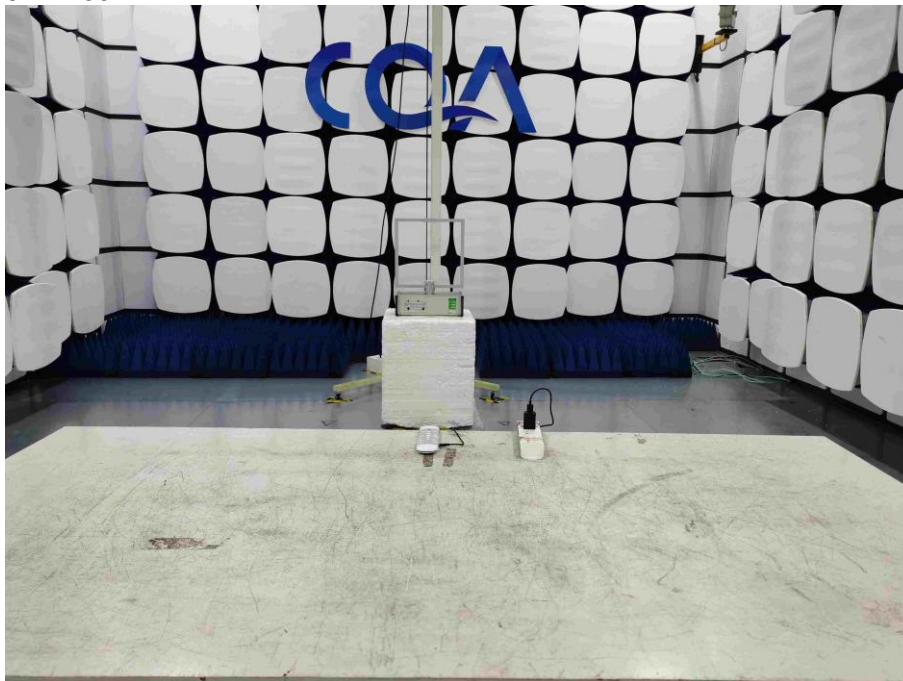

30MHz~1GHz:



Above 1GHz:

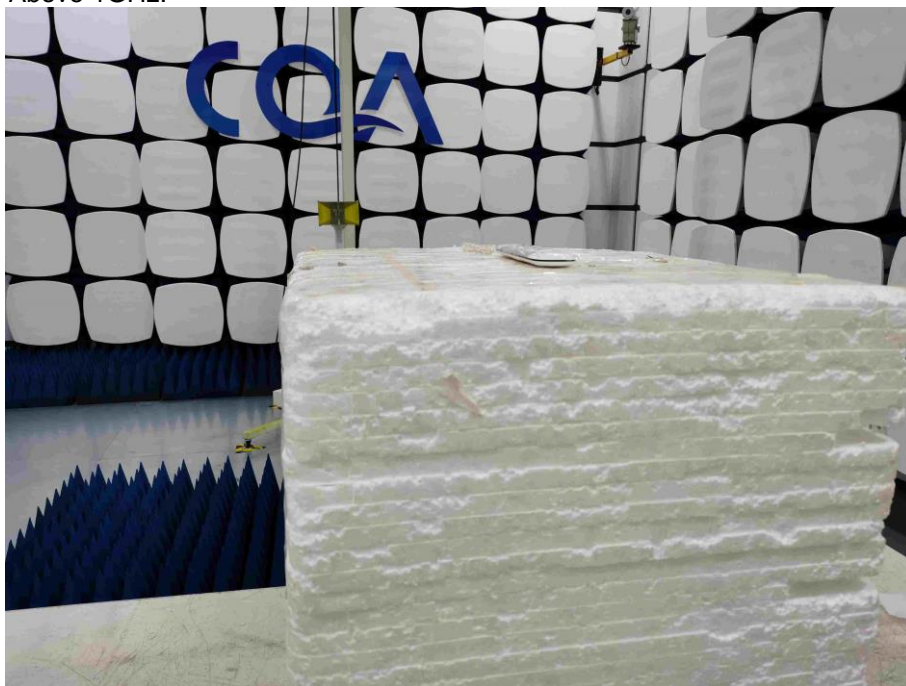

6.2 Conducted Emission Test Setup

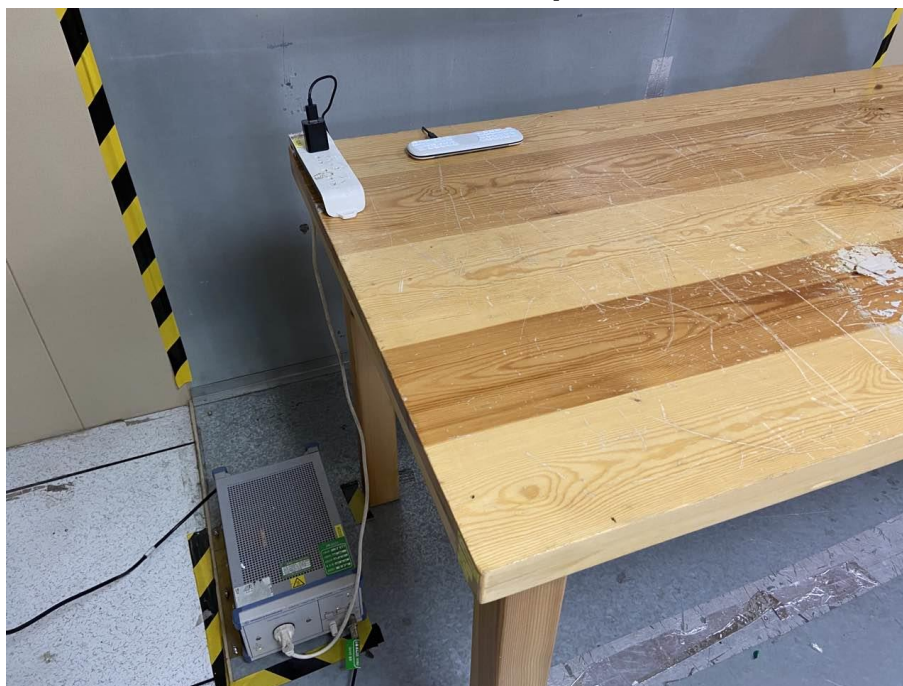

6.3 EUT Constructional Details

Test Model No.: CHY-Q40



