

NUX

MIGHTY MKII
NEW GENERATION AMP
Desktop Amp
TS/AC HD
White-Box
Amp Modeling algorithm

MIGHTY LITE BT MKII

Desktop Modeling Amplifier
多功能蓝牙吉他/贝斯音箱

Owner's Manual
使用手册



3W 3 Watt Output Power

 Bluetooth Connection

 7 Presets
Active function with App control

 10 Beat Styles
Realistic drum beats

WARNING

To reduce the risk of fire or electric shock, do not expose this appliance to rain or moisture.

CAUTION

This device complies with part 15 of the FCC Rules. Operation is subject to the following two conditions: (1) this device may not cause harmful interference, and (2) this device must accept any interference received, including interference that may cause undesired operation. Any changes or modifications not expressly approved by the party responsible for compliance could void the user's authority to operate the equipment.

NOTE: This equipment has been tested and found to comply with the limits for a Class B digital device, pursuant to Part 15 of the FCC Rules. These limits are designed to provide reasonable protection against harmful interference in a residential installation. This equipment generates, uses and can radiate radio frequency energy and, if not installed and used in accordance with the instructions, may cause harmful interference to radio communications. However, there is no guarantee that interference will not occur in a particular installation.

If this equipment does cause harmful interference to radio or television reception, which can be determined by turning the equipment off and on, the user is encouraged to try to correct the interference by one or more of the following measures:

- Reorient or relocate the receiving antenna.
- Increase the separation between the equipment and receiver.
- Connect the equipment into an outlet on a circuit different from that to which the receiver is connected.
- Consult the dealer or an experienced radio/TV technician for help.

The device has been evaluated to meet general RF exposure requirement.

This equipment should be installed and operated with minimum distance 20cm between the radiator &you body.



The lightning symbol within a triangle means, “Electrical caution!” It indicates the presence of information about operating voltage and potential risks of electrical shock.



The exclamation point within a triangle means, “Caution!” Please read the information next to all caution signs.

Introduction

Thank you for purchasing the NUX MIGHTY LITE BT MKII. Since launching the MIGHTY LITE BT in 2018, we have been hard at work incorporating the latest innovations in amp modeling into this brand new version. We hope you enjoy using it.

The MIGHTY LITE BT MKII provides a variety of effects for electric guitar and bass guitar including amp modeling and cabinet IRs. It also comes with acoustic amp modeling and acoustic IRs to let you simulate acoustic guitar tones. And, you can even load 3rd party IRs through Mighty Editor™ edit software to expand your tone. (You can load any WAV format IRs, the Mighty Editor™ will convert to 32bits/48kHz onto the device automatically.)



Note: There are 36 default IRs, and user IR slots are 18 (from 37 to 54).

Introduction

You can customize the presets through the MightyAmp™ APP (mobile) or Mighty Editor™ edit software (PC). You can do lots of things with the intuitive interface, experience it, feel the versatility and mighty!



The MightyAmp™ APP and Mighty Editor™ edit software let's you tweak all the signal blocks and parameters. The MIGHTY LITE BT MKII includes GATE, EFX, AMP, IR, MOD, DLY and RVB signal blocks. Along with the included 36 built-in IRs, there are 18 empty slots for 3rd party IRs loading. No need to worry about the sampling rate, Mighty Editor™ edit software can convert the WAV(IR) format automatically.

Introduction

The MIGHTY LITE BT MKII supports USB-C audio stream, which means that it can be an USB recording interface. It supports Normal / Dry Out / Re-amp / Loopback routing, you can adjust it through the MightyAmp™ APP or Mighty Editor™ edit software., no need to setup USB OUT in DAW. Even live stream jamming with Loopback!

**All of the brand and model names mentioned on this page are Trademarks of their respective owners, which are in no way associated or affiliated with NUX Effects and Cherub Technology CO. LTD.*

Control Panel

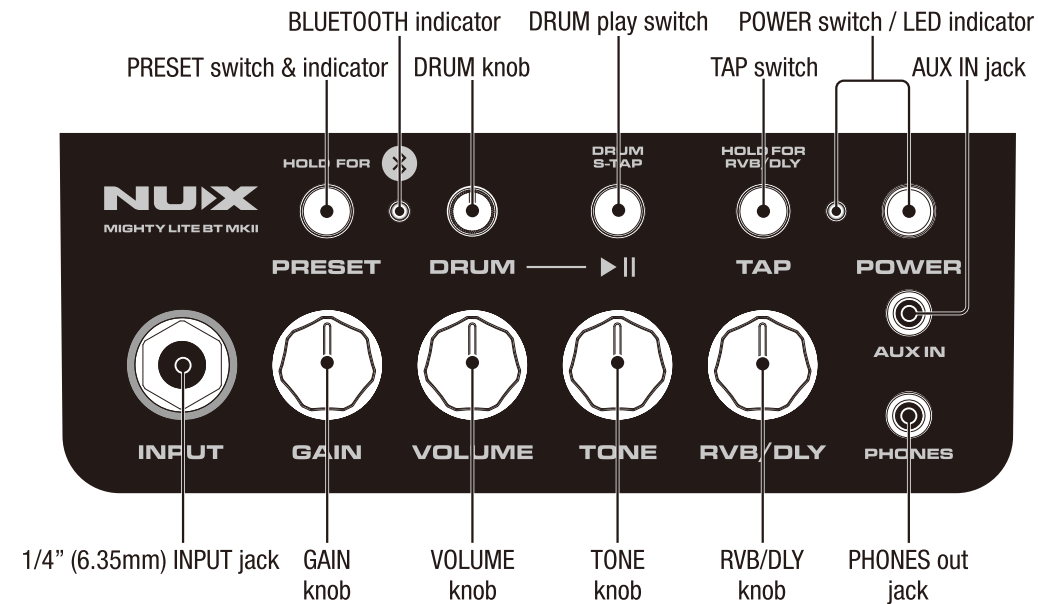

Operation

1/4" (6.35mm) INPUT jack

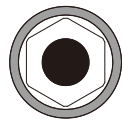

INPUT

Connect your guitar cable with guitar into INPUT jack.

POWER switch / LED indicator



POWER

Press the POWER switch to boot-up the amplifier, while the amp is on, the LED indicator will show "Red". While you turn off the amp, the LED indicator will turn off.

BLUETOOTH indicator



When connecting a Bluetooth enabled mobile device to the MIGHTY LITE BT MKII's Bluetooth audio, the BLUETOOTH indicator will turn on "Blue". (If not connected, the BLUETOOTH indicator will flash "Blue".)

Operation: You can connect Bluetooth Audio from "Settings" on the mobile phone to play audio through the MIGHTY LITE BT MKII. Click "Settings" on the mobile phone. Enter "Bluetooth", and choose "MIGHTY LITE BT MKII", while you connect MIGHTY LITE BT MKII's Bluetooth audio, you will hear a connection sound.



Settings

Operation

MightyAmp™ APP connects with the device.

Operation: Launch the MightyAmp™ APP on your mobile phone, and press "Settings" to choose "Current Amp" as "MIGHTY LITE BT MKII", then "Click to Scan Devices". The APP will find "MIGHTY LITE BT MKII". Now select it, and the APP will connect with the device.

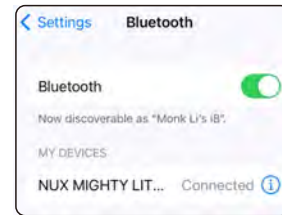
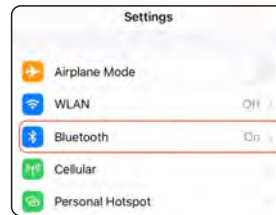

If you wish to disconnect the MIGHTY LITE BT MKII, just press and hold the PRESET button/indicator to disconnect. Then you can connect to MIGHTY LITE BT MKII manually.

Note: The Bluetooth audio and Bluetooth MIDI are independent, you have to connect them separately. Both of these connections must be made in order to use the MIGHTY LITE BT MKII's full functionality.

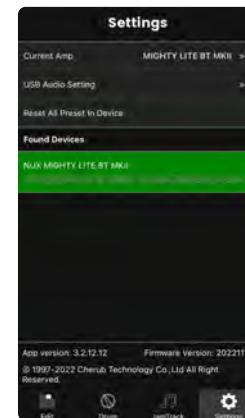

Operation

Note: The APP uses Bluetooth MIDI to communicate with the device.

Note: For Android OS, you may need to turn on GPS permission.
PRIVACY NOTE: We do not use your GPS to track you. Where you want to play music is your business, not ours!

Applications that scan for Bluetooth devices must request permission in the manifest file. This LOCATION permission is required because it may be possible to guess the location of an Android device by seeing which BTLE devices are nearby.

https://developer.android.com/reference/android/media/midi/package-summary#btle_location_permissions

PRESET switch & indicator



PRESET

While the device is engaged, you can press the PRESET switch to change the preset from 1~7. The indicator will display colors related to specific presets.

Note: You can adjust which preset can be ACTIVE while you press the PRESET switch through MightyAmp™ APP or Mighty Editor™ edit software. (ACTIVE function)

MightyAmp™ APP example:

Choose preset 1, 3, 5, 7 and press Active icon, then the device will know preset 1, 3, 5, 7 will be chosen while you press the PRESET switch.

Operation

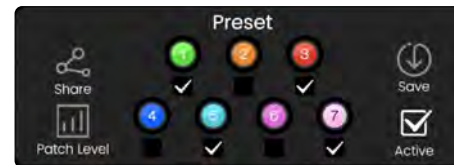

Mighty Editor™ example

Click icon, the 7 PRESETS will be COLORED, then choose the ones you want to active, like 1, 3, 5, 7. Then press icon again, Mighty Editor™ will show current preset, and according to the interface, you will see which is be chosen with .



Operation

GAIN knob

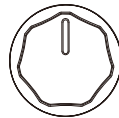

GAIN

Controls AMP MODEL's gain.

VOLUME knob



VOLUME

Controls AMP model's master.

TONE knob



TONE

Controls AMP model's Treble / Tone.

RVB/DLY knob



RVB/DLY

Controls RVB/DLY model's mix level.

Operation

TAP switch/indicator

HOLD FOR
RVB/DLY



TAP

Hold the TAP switch to choose RVB/DLY. In the meantime, the TAP indicator will show related block's color. For example, RVB is Purple. DLY will flash Surf-Green. Under DLY, tap the Tap switch to adjust Delay Time.

DRUM knob and DRUM play switch



DRUM

DRUM
S-TAP



▶ ||

DRUM knob and DRUM play switch: Press the DRUM play switch once to start the drum beat, more than twice will

become Smart Tap Tempo to adjust the drum tempo. During the drum playing, press the DRUM switch once to stop the drum beat. DRUM knob adjusts the drum volume.

*If you want to change the drum style, you have to use the MightyAmp™ APP or Mighty Editor™ edit software.

AUX IN jack



AUX IN

Connect a MP3 player into the 1/8" AUX IN jack to play audio tracks for jamming.

PHONES out jack



PHONES

Connect with headphones for silent practicing, the MIGHTY LITE BT MKII speaker will be automatically muted.

Backplane Interface

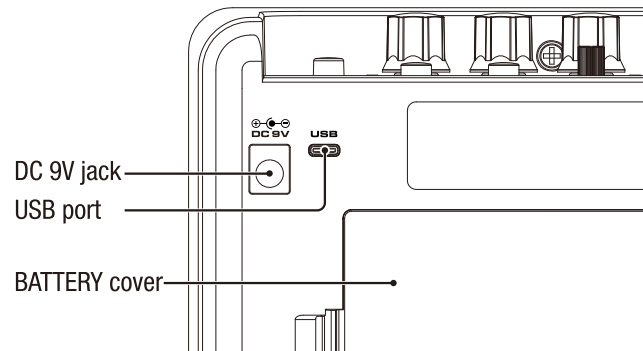

DC 9V jack



Connect the included power adaptor to power the MIGHTY LITE BT MKII.

USB port



This port is for the Mighty Editor™ edit software, USB audio stream, and Firmware updates.

Recording:

For WIN OS, please go to the product page to download ASIO driver for recording.

For MAC OS, the device supports CORE AUDIO, so there is no need for driver.

Firmware Update:

Connect USB with PC, hold the TAP switch and turn on the device by pressing POWER switch to enter to DFU (Device Firmware Update) mode. Then use DFU updater software to update the firmware. (You can get the firmware and firmware update guide on the product page.)

Battery Installation

MIGHTY LITE BT MKII can be powered by 6 AA batteries.

It takes 6 pieces AA batteries to power on the NUX Mighty Lite BT MKII amplifier, if you want to use battery as power source or change batteries, please open the battery compartment cover located on the back of the amplifier.

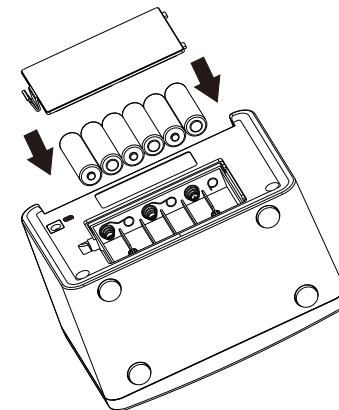

Mobile APP & Edit Software

Be sure to check out the MIGHTY LITE BT MKII tutorials on our NUX YouTube channel for more pro tips.

The MightyAmp™ APP allows you to tweak parameters. You can also set Events on any selected JamTrack or load custom tracks into your phone through the PC.

The Mighty Editor™ software can load 3rd party IRs, and tweak parameters for all included effects.

Mobile APP & Edit Software



MightyAmp™



Mighty Editor™

Features

- 3 watt desktop Modeling Amplifier.
- TSAC-HD (White-Box) Amp Modeling algorithm offers realistic playability & feedback.
- 512 samples IR resolution. (36 premium built-in IRs and 18 user slots for 3rd party)
- 7 presets with ACTIVE functions. (PRESET switch toggles ACTIVE ones sequentially.)
- GATE, EFX, AMP, IR, MOD, DLY, RVB effect blocks.
- White-box algorithm EFX offers analog response and natural chaos.
- Patch Level function for each preset.
- Drum machine.
- Intuitive MightyAmp™ APP & Mighty Editor™ edit software(3rd party IR loader).
- USB-C: Mighty Editor™ edit software communication, USB audio stream, and Firmware update.

Specifications

- Input Impedance: 680K Ω
- AUX In Impedance: 13K Ω
- Earphone Output Impedance: 32 Ω
- Sampling Rate: 48KHz / 32-bit
- System Latency: 1.42ms
- Current Draw: 9VDC / Battery 120mA, USB 185mA
- Speaker: 3" , 4 Ω , 5W
- Dimensions: 166(L) x 98(W) x 124(H)mm
- Weight: 720g

*Specifications and appearance subject to change without notice.

Accessories: Adapter, User manual, Warranty card, NUX sticker.



©2023 Cherub Technology-All rights reserved. No part of this publication may be reproduced in any form without prior written permission of Cherub Technology.

www.nuxefx.com Made in China

请注意！重要安全说明。
在连接使用前，阅读以下说明。

警告: 为减少火灾或触电的危险，请勿将本产品置于雨中或潮湿的地方。

注意: 为避免火灾或触电等危险，请勿擅自拆卸本产品。维修本产品内部部件对于非专业人员来说较为困难，若有损坏请交给专业维修人员处理。

注意: 本产品已经过测试，证明符合FCC规则第15部分的B级数字设备的限制规定。操作应符合以下两个条件：（1）本产品不会产生有害干扰，且（2）本产品必须接受任何干扰，包括可能会导致非正常操作的干扰。

1. 仅能使用与出厂附带规格相同的电源适配器。如果您不确定可用的电源适配器类型，请咨询您的经销商。
2. 本产品不应遭受水滴或水溅，本产品上不应放置诸如花瓶一类的装满液体的物品。
3. 请勿放置在热源附近，如散热器、电热器，或其它产生高热量的设备。
4. 如果电池更换不当会有爆炸危险，只能用同类型或等效类型的电池来更换。
5. 请勿尝试自行维修本产品。如需维修，请联系我司售后热线，或交给专业的维修人员。
6. 当本产品遭遇电源适配器损坏、不明物体进入、进水等情况，请谨慎使用，并主动联系售后维修。
7. 如果长时间不使用本产品，应拔掉电源线。
8. 避免踩踏电源线，避免过度绷紧电源线。
9. 人耳长时间接收高音音量声音可能会导致无法挽回的听力损害，请始终保持“安全聆听”。

请遵守所有的指示和注意所有警告并保留这些说明！

产品简介

感谢您选择并购买NUX MIGHTY LITE BT MKII多功能蓝牙吉他/贝斯音箱。相较于发布于2018年的初代MIGHTY LITE BT，MKII最大的亮点在于它应用了我司在音箱模拟这一领域最新的研发成果。我们衷心希望您在使用这款音箱时能感受到快乐，就像我们的工程师在取得技术突破后所感受到喜悦一样。

NUX MIGHTY LITE BT MKII内置了一系列吉他和贝斯用效果，包括音箱模拟、箱体IR。想要模拟木吉他音色？交给我们，MKII有木吉他音箱模拟以及木吉他IR。嫌出厂IR不够多？交给我们，MKII配套的编辑软件（Mighty Editor™）可以随心导入第三方IR文件（小声说一句，编辑软件自带格式转换功能，导入的第三方IR文件会自动被转换成32bit/48kHz wav格式）。

***注意：**出厂IR数量为36个，用户IR存储位置为18个（位置编号：37-54）。



产品简介

使用NUX MIGHTY LITE BT MKII面板上的旋钮、按键可以快速切换预设、控制鼓机以及简单地调整音色。若要深入编辑音色，我们建议您使用MightyAmp™移动端应用或Mighty Editor™桌面端编辑软件。不管是移动端应用还是桌面端软件，功能都非常强大，界面都非常直观，调整起来也都十分方便。

NUX MIGHTY LITE BT MKII信号链包括7大效果模块（GATE, EFX, AMP, IR, MOD, DLY以及RVB），使用MightyAmp™移动端应用或Mighty Editor™桌面端软件可以调节各个模块下效果或音箱模型的参数。

MIGHTY LITE BT MKII背部的USB Type C接口支持音频串流，这意味着您可以将其用作USB录音声卡，支持Normal, Dry Out, Re-amp以及Loop Back四种模式。您可以根据实际需要，使用MightyAmp™或Mighty Editor™来选择合适的模式，不再需要设置DAW的USB OUT。您甚至还可以使用Loop Back模式来直播弹琴。

***注意：**本说明书中所提及的其他产品名称、注册商标和公司名词属于其各所有者，与纽克斯效果器或深圳蔚科电子科技有限公司无任何关联或附属关系。提及仅用于功能或特性说明，而非侵犯其各所有者的各项权利。

控制面板

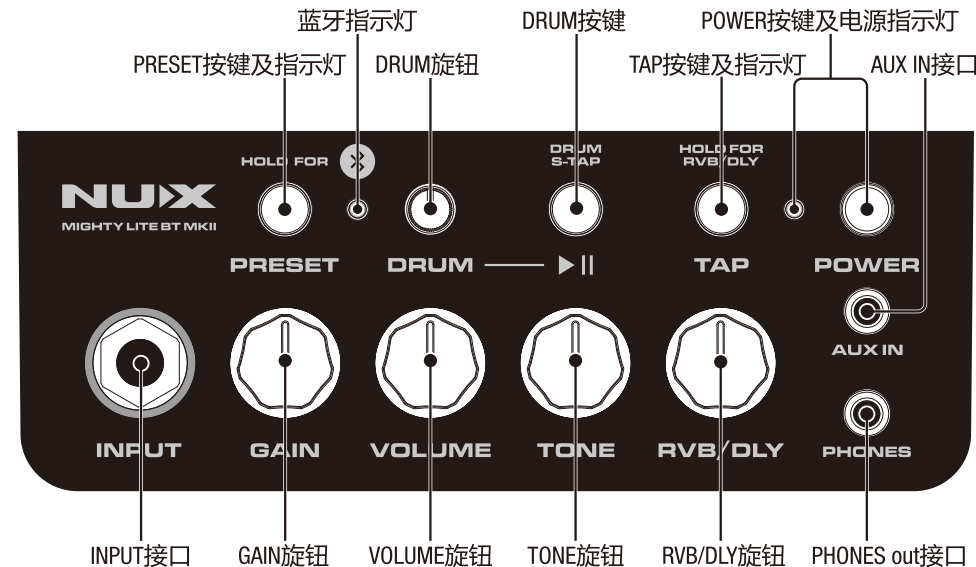

操作说明

INPUT接口

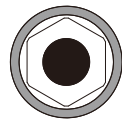

INPUT

6.35mm单声道输入接口，请将您的电吉他或贝斯通过连接线接入此接口。

POWER按键及电源指示灯



POWER

按下POWER按键可以打开或关闭MKII。

MKII处于开机状态时，电源指示灯呈红色长亮状态；

MKII处于关机状态时，电源指示灯呈熄灭状态。

蓝牙指示灯



蓝牙音频状态指示灯。

蓝牙音频连接指南：

1. 确认MKII处于开机状态。
2. 进入手机或平板电脑的设置选项，找到蓝牙设置菜单。
3. 进入蓝牙设置菜单，在蓝牙设备标题下找到名称为“NUX MIGHTY LITE BT MKII”的蓝牙设备，点击进行连接。

连接成功后，会有提示音响起，同时蓝牙指示灯会保持蓝色常亮状态。当MKII蓝牙音频处于断连的状态时，蓝牙指示灯呈蓝色闪烁状态。

***注意：**蓝牙音频与蓝牙MIDI是相对独立的，初次使用时，您需要分别进行一次手动连接。蓝牙音频与蓝牙MIDI两个连接均建立后您才能使用MKII完整的功能。

操作说明



Settings

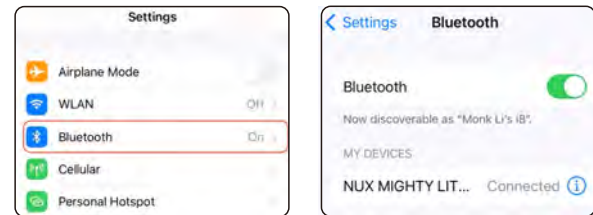

蓝牙MIDI (MightyAmp™) 连接指南：

1. 确认MKII处于开机状态并在手机或平板电脑上打开MightyAmp™ APP。
2. 点击下方标签栏上的Settings图标进入设置列表，点击Current Amp (当前音箱) 进入设备选择页面，然后点选“MIGHTY LITE BT MKII”选定设备。

3. 选定设备后，点击设置列表下方的“Click to scan device (点击后开始扫描设备)”，App开始自动扫描附近蓝牙MIDI设备。
4. 当“MIGHTY LITE BT MKII”出现在“Found Devices (已找到的设备)”标题下时，点击“MIGHTY LITE BT MKII”进行连接。

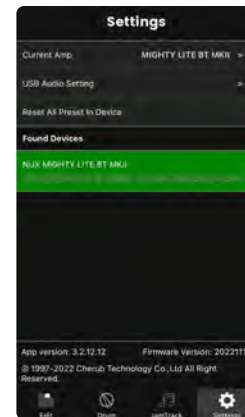
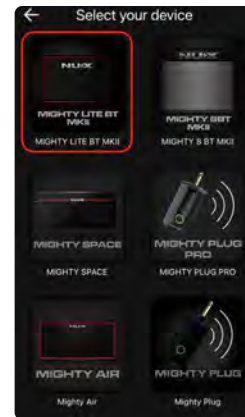

操作说明

蓝牙MIDI连接成功后，您可以使用MightyAmp™ APP来控制MKII。

***注意：** MightyAmp™与MIGHTY LITE BT MKII是通过蓝牙MIDI来完成各项指令的。

***注意：** 多数安卓用户可能需要为MightyAmp™ APP开启位置权限，但是我们不会收集您的隐私。如果您想了解安卓系统为什么需要开启位置权限，请参考安卓官方的开发者文档：https://developer.android.com/reference/android/media/midi/package-summary#btlocation_permissions

PRESET按键及指示灯



PRESET

预设切换按键，MIGHTY LITE BT MKII内置7个预设，短按PRESET按键可循环切换预设。

切换预设后，PRESET按键指示灯的颜色也会随之变化。

提示： 您可以使用MightyAmp™或Mighty Editor™来选择用户自选预设。用户自选预设：您可以勾选任意数量的预设，以便简化切换预设的流程。

例： 吉他手大鹏日常练习需要使用四个预设，使用Mighty Editor™进行一番调整后大鹏在预设1、预设3、预设4以及预设7四个位置上编辑并保存了预设。此时，大鹏只需要取消勾选预设2、预设5以及预设6三个预设并保存设置。这之后，大鹏便可以使用PRESET按键在这四个预设之间进行切换。

操作说明

Mighty Editor™ 示例：



MightyAmp™ APP 示例：



操作说明

GAIN旋钮

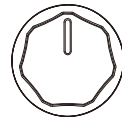

GAIN

调节当前预设AMP模块下所选音箱模型的增益大小。

VOLUME旋钮



VOLUME

调节当前预设AMP模块下所选音箱模型的整体音量大小。

TONE旋钮



TONE

调节当前预设AMP模块下所选音箱模型的Treble和Tone。

RVB/DLY旋钮



RVB/DLY

调节当前预设混响效果或延迟效果的混合比。

操作说明

TAP按键及指示灯

HOLD FOR
RVB/DLY



TAP

按住TAP按键来选择RVB/DLY旋钮的控制项，您可以依据TAP按键指示灯的状态来作出判断：

TAP按键指示灯呈紫色时，RVB旋钮控制混响效果的混合比；
TAP按键指示灯呈冲浪绿闪烁状态时，有节奏地连续按压TAP按键可以打点设速设置延迟时间。

DRUM旋钮及DRUM按键



DRUM

DRUM
S-TAP



DRUM S-TAP

按DRUM按键一次来激活鼓机，有节奏的连续按压DRUM按键可以打点设速设置鼓机的速度。

鼓机工作时，按一次DRUM按键可以停止鼓机，转动DRUM旋钮可以调节鼓机的音量大小。

AUX IN接口



AUX IN

3.5mm音频输入接口。可外接音频播放设备播放伴奏。

PHONES out接口



PHONES

3.5mm音频输出接口。可连接耳机进行静音练习。

背板接口

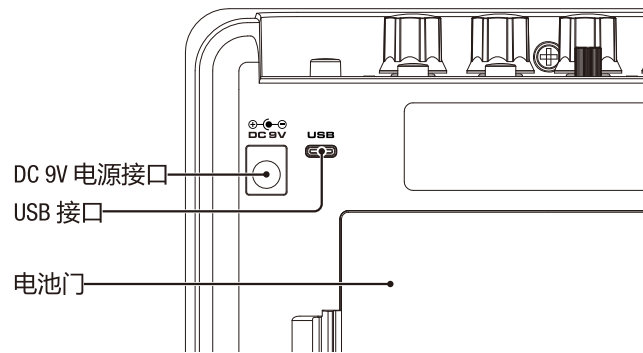

DC 9V电源接口



将附赠的电源适配器通过此接口连接至MIGHTY LITE BT MKII为音箱供电。

USB接口



USB-C数据接口，可连接电脑进行固件更新、使用Mighty Editor™编辑音色或录音。

固件更新需要使用高品质数据线并按照NUX MIGHTY LITE BT MKII产品页面底部固件更新指南所述步骤进行操作。

将MKII用作USB声卡时，Windows用户需要提前安装NUX ASIO驱动；MacOs原生支持Core Audio即插即用。

电池安装

MIGHTY LITE BT MKII可以使用6节AA电池为音箱供电，如果您需要使用电池供电或更换电池，请打开位于音箱背后的电池仓盖，如下图所示安装电池：

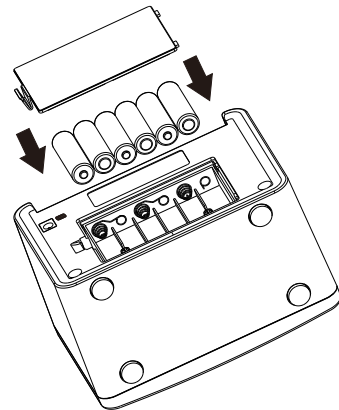

MightyAmp™和Mighty Editor™

您可以访问MKII产品页面、我司微信公众号或bilibili获取更多产品文字及视频介绍。MightyAmp™ APP是MIGHTY LITE BT MKII配套的音色编辑应用，您可以使用它编辑预设音色以及解锁更多隐藏功能。此外，MightyAmp™的伴奏播放功能不仅支持导入伴奏甚至还支持自定义事件（例：AB循环）。

Mighty Editor™是桌面端软件与MightyAmp™ APP的功能基本一致，但调节界面更为直观，最大的区别是Mighty Editor™可以导入第三方IR。



纽克斯微信公众平台



bilibili纽克斯官方账号



纽克斯交流群

Mighty Amp™和Mighty Editor™

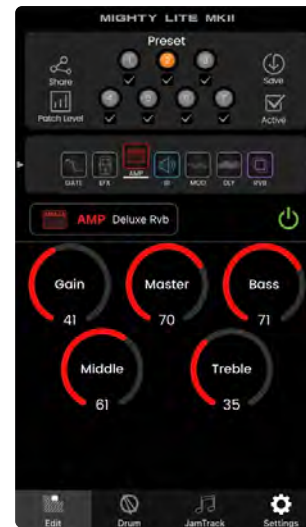

MightyAmp™界面



Mighty Editor™界面

产品特点

- 小而不凡3瓦桌面小音箱。
- TS/AC-HD白盒建模音箱模拟算法，提供真实的演奏手感和反馈。
- 支持512点IR，36个出厂IR，18个用户IR存储位置。
- 7个预设带用户自选预设功能。
- 7大效果模块。
- Patch level调节。
- 内置鼓机。
- 易于上手的移动端和桌面端音色编辑软件。
- 支持电池供电、USB供电以及电源适配器供电。

技术规格

- INPUT接口输入阻抗：680K Ω
- AUX IN接口输入阻抗：13K Ω
- PHONES OUT接口输出阻抗：32 Ω
- 采样率：48KHz / 32-bit
- 系统延迟：1.42ms
- 电流消耗：9VDC / Battery 120mA, USB 185mA
- 喇叭：3”，4 Ω ，5W
- 体积：166 (L) x 98 (W) x 124 (H)mm
- 重量：720g

*技术规格如有变更，恕不另行通知。

附件： 电源适配器、使用说明书、保修卡、NUX贴纸。

有关产品中所含有害物质的说明

为了控制和减少电器电子产品废弃后对环境造成的污染，本资料就本公司产品中所含的特定有害物质及其安全性予以说明。

本资料适用于2016年7月1号以后本公司所制造的产品。

环保使用期限



此标志适用于在中国国内销售的电子信息产品，表示环保使用期限的年数。所谓环保使用期限是指在制造日起的规定期限内，产品中所含的有害物质不致引起环境污染，不会对人身、财产造成严重的不良影响。环保使用期限仅在遵照产品使用说明，正确使用产品的条件下才有效。不当的使用，将会导致有害物质泄漏的危险。

产品中有害物质的名称及含量

部件名称		有害物质					
		铅(Pb)	汞(Hg)	镉(Cd)	六价铬(Cr(VI))	多溴联苯(PBB)	多溴二苯醚(PBDE)
主体	塑胶件	○	○	○	○	○	○
	五金件	×	○	○	○	○	○
	硅胶件	○	○	○	○	○	○
	内置电路板	×	○	○	○	○	○
附件	*交流电源适配器、线缆	×	○	○	○	○	○

*表示某些产品可能不含有这些项目，上表当中的信息仅在产品含有这些项目时适用。

本表格依据SJ/T 11364的规定编制。

○：表示该有害物质在该部件所有均质材料中的含量均在GB/T 26572规定的限量要求以下。

×：表示该有害物质至少在该部件的某一均质材料中的含量超出GB/T 26572规定的限量要求，因根据现有的技术水平，还没有什么物质能够代替它。

保护环境

如果需要废弃本产品，请遵循本地相关指引，请勿随意丢弃或作为生活垃圾处理，以避免对环境造成污染。

质量承诺

亲爱的 **NUX** 用户：

在您使用 **NUX** 产品时，请仔细阅读产品说明书，当您有疑问和困难时，请拨打售后服务热线：**400-990-9866**

- 一周内出现质量问题可退货退款
- 一年内出现质量问题可免费维修
- 一月内出现质量问题可调换
- 终身享有咨询和维修服务

[请向销售商索取正规发票并予以保存]

换修政策

一、包换政策：

- 1、消费者通过正规授权渠道购买的产品，自购机之日起1个月之内，在正常使用情况下出现非人为的产品性能故障、且产品外观及包装保持完好，可向所购机的经销商换机。
- 2、消费者在换机时应出示由经销商开出的购机凭证，否则经销商可以不予更换。

二、保修政策：

- 1、消费者通过正规授权渠道购买的产品(以发票所示销售方为准)，自购买之日起1年内，若出现非人为损坏的性能故障，可享受免费维修服务。
- 2、对于超过1年或人为及不可抗力因素造成损坏的产品，我司可提供有偿维修服务。

*本售后政策仅适用于中国大陆地区，其它国家及地区以当地售后政策及法律法规为准。

售后服务地址

广东省珠海市高新区唐家湾镇科技九路10号
珠海市蔚科科技开发有限公司 售后服务部
邮编: 519085

制造商

深圳市蔚科电子科技开发有限公司

制造商地址

深圳市南山区蛇口兴华路6号南海意库1号楼507
电话: 0755 - 2686 9866
网址: cn.nuxefx.com

生产商

珠海市蔚科科技开发有限公司

生产商地址

珠海市高新区唐家湾镇科技九路10号
电话: 0756-3689866

合格证
Certificate

检验员
Inspector

名称 多功能蓝牙吉他/贝斯音箱
Name

型号 MIGHTY LITE BT MKII
Type

生产日期
Date

本产品经检验合格
This product is inspected and approved.
执行标准: Q/WKDZ 002-2020
Product is certificated with Q/WKDZ 002-2020