



中认信通
CHINA CERTIFICATION ICT CO., LTD (DONGGUAN)



TEST REPORT

Applicant: Cherub Technology Co., Ltd

Address: Room507, Block 1, Nanhai E-Cool, No. 6 Xinghua Shekou, Nanshan District, Shenzhen, China

FCC ID: 2AOAA-MIGHTYSPACE

Product Name: Wireless Stereo Modeling Amplifier

**Standard(s): 47 CFR Part 15, Subpart C(15.247)
ANSI C63.10-2013
KDB 558074 D01 15.247 Meas Guidance v05r02**

The above equipment has been tested and found compliant with the requirement of the relative standards by China Certification ICT Co., Ltd (Dongguan)

Report Number: CR22080062-00A

Date Of Issue: 2022-10-04

Reviewed By: Sun Zhong

Sun Zhong

Title: Manager

Test Laboratory: China Certification ICT Co., Ltd (Dongguan)
No. 113, Pingkang Road, Dalang Town, Dongguan,
Guangdong, China
Tel: +86-769-82016888

Test Facility

The Test site used by China Certification ICT Co., Ltd (Dongguan) to collect test data is located on the No. 113, Pingkang Road, Dalang Town, Dongguan, Guangdong, China.

The lab has been recognized as the FCC accredited lab under the KDB 974614 D01 and is listed in the FCC Public Access Link (PAL) database, FCC Registration No. : 442868, the FCC Designation No. : CN1314.

The lab has been recognized by Innovation, Science and Economic Development Canada to test to Canadian radio equipment requirements, the CAB identifier: CN0123.

Declarations

China Certification ICT Co., Ltd (Dongguan) is not responsible for the authenticity of any test data provided by the applicant. Data included from the applicant that may affect test results are marked with a triangle symbol “▲”. Customer model name, addresses, names, trademarks etc. are not considered data.

Unless otherwise stated the results shown in this test report refer only to the sample(s) tested.

This report cannot be reproduced except in full, without prior written approval of the Company.

This report is valid only with a valid digital signature. The digital signature may be available only under the Adobe software above version 7.0.

This report may contain data that are not covered by the accreditation scope and shall be marked with an asterisk “★”.

CONTENTS

TEST FACILITY	2
DECLARATIONS.....	2
1. GENERAL INFORMATION	5
1.1 PRODUCT DESCRIPTION FOR EQUIPMENT UNDER TEST (EUT)	5
1.2 DESCRIPTION OF TEST CONFIGURATION.....	6
1.2.2 Support Equipment List and Details	6
1.2.3 Support Cable List and Details	6
1.2.4 Block Diagram of Test Setup.....	7
1.3 MEASUREMENT UNCERTAINTY	8
2. SUMMARY OF TEST RESULTS	9
3. REQUIREMENTS AND TEST PROCEDURES	10
3.1 AC LINE CONDUCTED EMISSIONS.....	10
3.1.1 Applicable Standard.....	10
3.1.2 EUT Setup.....	11
3.1.3 EMI Test Receiver Setup	11
3.1.4 Test Procedure	12
3.1.5 Corrected Amplitude & Margin Calculation.....	12
3.2 RADIATION SPURIOUS EMISSIONS	13
3.2.1 Applicable Standard.....	13
3.2.2 EUT Setup.....	13
3.2.3 EMI Test Receiver & Spectrum Analyzer Setup	14
3.2.4 Test Procedure	14
3.2.5 Corrected Amplitude & Margin Calculation.....	14
3.3 6 dB EMISSION BANDWIDTH:.....	15
3.3.1 Applicable Standard.....	15
3.3.2 EUT Setup.....	15
3.3.3 Test Procedure	15
3.4 MAXIMUM PEAK CONDUCTED OUTPUT POWER:.....	16
3.4.1 Applicable Standard.....	16
3.4.2 EUT Setup.....	16
3.4.3 Test Procedure	16
3.5 MAXIMUM POWER SPECTRAL DENSITY:	17
3.5.1 Applicable Standard.....	17
3.5.2 EUT Setup.....	17
3.5.3 Test Procedure	17
3.6 100 KHZ BANDWIDTH OF FREQUENCY BAND EDGE:	18
3.6.1 Applicable Standard.....	18
3.6.2 EUT Setup.....	18
3.6.3 Test Procedure	18
3.7 DUTY CYCLE:.....	19
3.7.1 EUT Setup.....	19

3.7.2 Test Procedure19

3.8 ANTENNA REQUIREMENT.....19

3.8.1 Applicable Standard.....19

3.8.2 Judgment.....19

4. Test DATA AND RESULTS 20

4.1 AC LINE CONDUCTED EMISSIONS.....20

4.2 RADIATION SPURIOUS EMISSIONS23

4.3 6 dB EMISSION BANDWIDTH:30

4.4 MAXIMUM PEAK CONDUCTED OUTPUT POWER:33

4.5 MAXIMUM POWER SPECTRAL DENSITY:34

4.6 100 KHZ BANDWIDTH OF FREQUENCY BAND EDGE:37

4.7 DUTY CYCLE:.....40

5. RF EXPOSURE EVALUATION 42

5.1 APPLICABLE STANDARD.....42

5.2 PROCEDURE.....42

5.3 MEASUREMENT RESULT42

1. GENERAL INFORMATION

1.1 Product Description for Equipment under Test (EUT)

EUT Name:	Wireless Stereo Modeling Amplifier
EUT Model:	MIGHTY SPACE
Operation Frequency:	2402-2480 MHz
Maximum Peak Output Power (Conducted):	0.03 dBm
Modulation Type:	GFSK
Rated Input Voltage:	DC 15V from adapter or DC 11.1V from battery
Serial Number:	CR22080062-RF-S1
EUT Received Date:	2022.9.1
EUT Received Status:	Good

Operation Frequency Detail:

For BLE:

Channel	Frequency (MHz)	Channel	Frequency (MHz)
0	2402	20	2442
1	2404
...
...
..	...	38	2478
19	2440	39	2480

Per section 15.31(m), the below frequencies were performed the test as below:

Test Channel	Frequency (MHz)
Lowest	2402
Middle	2440
Highest	2480

Antenna Information Detail▲:

Antenna Manufacturer	Antenna Type	input impedance (Ohm)	Antenna Gain /Frequency Range	§15.203 Requirement
Actions (Zhuhai) Technology Co., Limited	PCB	50	1.54 dBi/ 2.4~2.5GHz	Compliance

The Method of §15.203 Compliance:

- Antenna must be permanently attached to the unit.
- Antenna must use a unique type of connector to attach to the EUT.
- Unit must be professionally installed, and installer shall be responsible for verifying that the correct antenna is employed with the unit.

Accessory Information:

Accessory Description	Manufacturer	Model	Parameters
Adapter	SHENZHEN HONOR ELECTRONIC CO.,CTD.	ADS-40NP-12-1 15038E	Input:100-240V, 50~60Hz,1A Output:15V,2.5A
Power Cable	Unknown	Unknown	Unshielded, 0.5m
Aux Cable	Unknown	Unknown	Unshielded, 1.2m
USB Cable	Unknown	Unknown	Unshielded, 1m

1.2 Description of Test Configuration**1.2.1 EUT Operation Condition:****For BLE:**

EUT Operation Mode:	The system was configured for testing in Engineering Mode, which was provided by the manufacturer.		
Equipment Modifications:	No		
EUT Exercise Software:	BT FCC Tool V2.24		
The software was provided by manufacturer. The maximum power was configured as below, that was provided by the manufacturer ▲ :			
Test Modes	Power Level Setting		
	Lowest Channel	Middle Channel	Highest Channel
1Mbps	8	8	8
2Mbps	8	8	8

1.2.2 Support Equipment List and Details

Manufacturer	Description	Model	Serial Number
Mighty Space	B-5 TX	B-5 TX	Unknown
Mighty Space	Drum&Loop Foot Switch	NMP-2	Unknown
Mighty Space	Speaker out load	Load	Unknown
Huawei	Phone	BLN-AL40	BLN-AL40C00B120
1MORE	Earphone	1m301	5521427
Lenovo	Laptop	T460S	60PDTEK8

1.2.3 Support Cable List and Details

Cable Description	Shielding Type	Ferrite Core	Length (m)	From Port	To
Earphone Cable	No	No	1.5	EUT	Earphone
TRS Cable*3	No	Yes	1.2	EUT	Load
USB Cable	No	No	2	Laptop	EUT

1.2.4 Block Diagram of Test Setup

AC line conducted emissions:

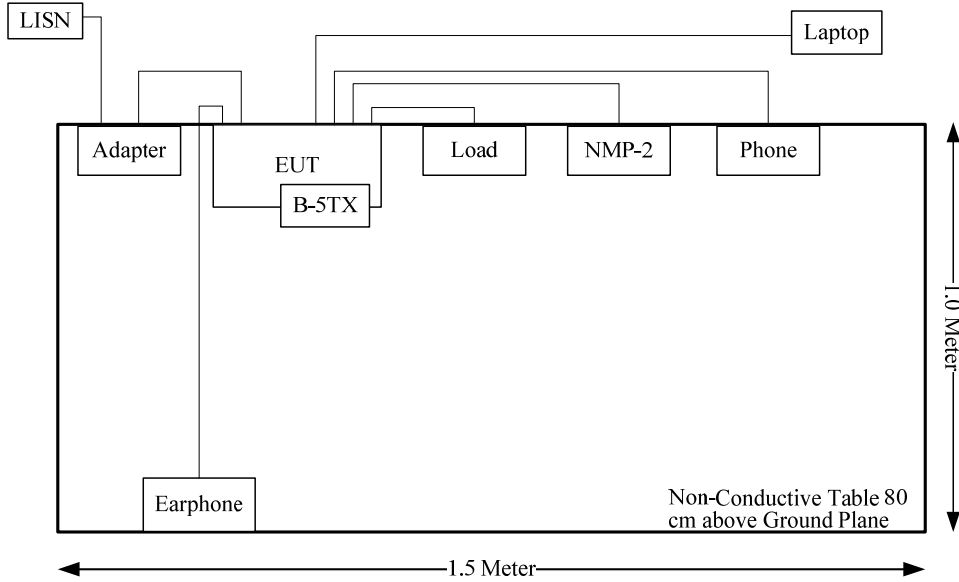

Spurious Emissions:

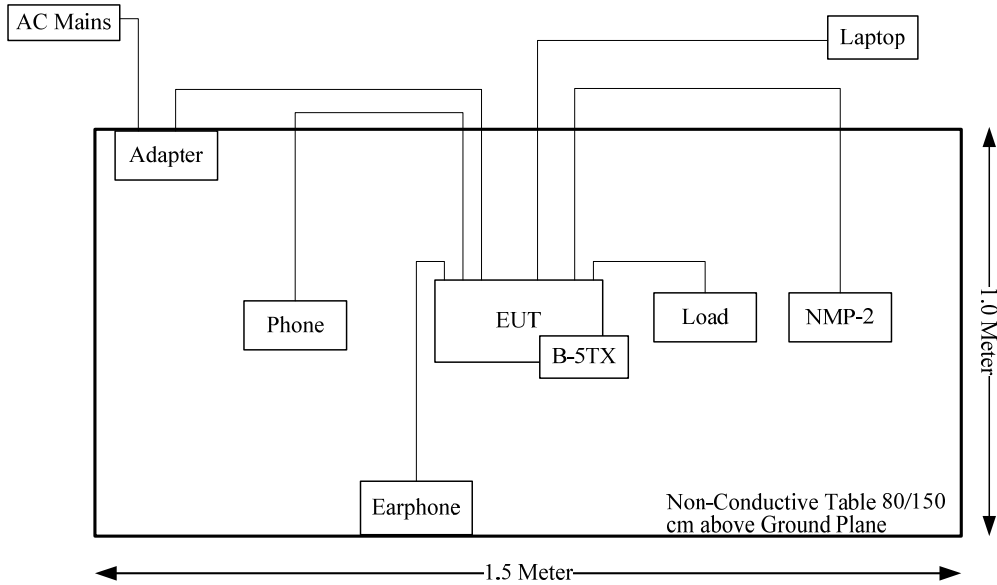

1.3 Measurement Uncertainty

Otherwise required by the applicant or Product Regulations, Decision Rule in this report did not consider the uncertainty. The extended uncertainty given in this report is obtained by combining the standard uncertainty times the coverage factor K with the 95% confidence interval.

Parameter	Measurement Uncertainty
Occupied Channel Bandwidth	±5 %
RF output power, conducted	±0.61dB
Power Spectral Density, conducted	±0.61 dB
Unwanted Emissions, radiated	30M~200MHz: 4.15 dB,200M~1GHz: 5.61 dB,1G~6GHz: 5.14 dB, 6G~18GHz: 5.93 dB,18G~26.5G:5.47 dB,26.5G~40G:5.63 dB
Unwanted Emissions, conducted	±1.26 dB
Temperature	±1 °C
Humidity	±5%
DC and low frequency voltages	±0.4%
Duty Cycle	1%
AC Power Lines Conducted Emission	2.8 dB (150 kHz to 30 MHz)

2. SUMMARY OF TEST RESULTS

Standard(s) Section	Test Items	Result
§15.207(a)	AC line conducted emissions	Compliant
§15.205, §15.209, §15.247(d)	Spurious Emissions	Compliant
§15.247 (a)(2)	6 dB Bandwidth	Compliant
§15.247(b)(3)	Maximum Conducted Output Power	Compliant
§15.247(d)	100 kHz Bandwidth of Frequency Band Edge	Compliant
§15.247(e)	Power Spectral Density	Compliant
§15.203	Antenna Requirement	Compliant
FCC§15.247 (i) & §1.1307	RF Exposure	Compliant

3. REQUIREMENTS AND TEST PROCEDURES

3.1 AC Line Conducted Emissions

3.1.1 Applicable Standard

FCC§15.207(a).

(a) Except as shown in paragraphs (b) and (c) of this section, for an intentional radiator that is designed to be connected to the public utility (AC) power line, the radio frequency voltage that is conducted back onto the AC power line on any frequency or frequencies, within the band 150 kHz to 30 MHz, shall not exceed the limits in the following table, as measured using a 50 μ H/50 ohms line impedance stabilization network (LISN). Compliance with the provisions of this paragraph shall be based on the measurement of the radio frequency voltage between each power line and ground at the power terminal. The lower limit applies at the boundary between the frequency ranges.

Frequency of emission (MHz)	Conducted limit (dB μ V)	
	Quasi-peak	Average
0.15-0.5	66 to 56*	56 to 46*
0.5-5	56	46
5-30	60	50

*Decreases with the logarithm of the frequency.

(b) The limit shown in paragraph (a) of this section shall not apply to carrier current systems operating as intentional radiators on frequencies below 30 MHz. In lieu thereof, these carrier current systems shall be subject to the following standards:

(1) For carrier current system containing their fundamental emission within the frequency band 535-1705 kHz and intended to be received using a standard AM broadcast receiver: no limit on conducted emissions.

(2) For all other carrier current systems: 1000 μ V within the frequency band 535-1705 kHz, as measured using a 50 μ H/50 ohms LISN.

(3) Carrier current systems operating below 30 MHz are also subject to the radiated emission limits in §15.205, §15.209, §15.221, §15.223, or §15.227, as appropriate.

(c) Measurements to demonstrate compliance with the conducted limits are not required for devices which only employ battery power for operation and which do not operate from the AC power lines or contain provisions for operation while connected to the AC power lines. Devices that include, or make provisions for, the use of battery chargers which permit operating while charging, AC adapters or battery eliminators or that connect to the AC power lines indirectly, obtaining their power through another device which is connected to the AC power lines, shall be tested to demonstrate compliance with the conducted limits.

3.1.2 EUT Setup

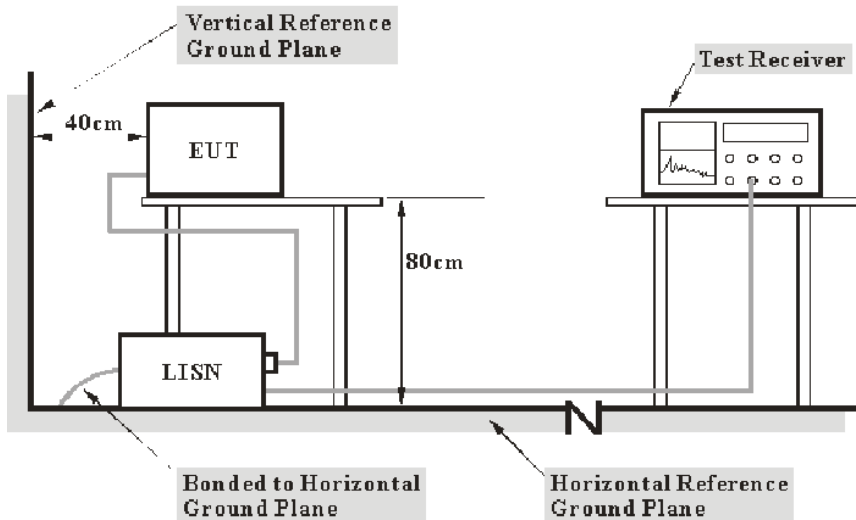

- Note: 1. Support units were connected to second LISN.
 2. Both of LISNs (AMN) 80 cm from EUT and at the least 80 cm from other units and other metal planes support units.

The setup of EUT is according with per ANSI C63.10-2013 measurement procedure. The specification used was with the FCC Part 15.207 limits.

The spacing between the peripherals was 10 cm.

The adapter or EUT was connected to the main LISN with a 120 V/60 Hz AC power source.

3.1.3 EMI Test Receiver Setup

The EMI test receiver was set to investigate the spectrum from 150 kHz to 30 MHz.

During the conducted emission test, the EMI test receiver was set with the following configurations:

Frequency Range	IF B/W
150 kHz – 30 MHz	9 kHz

3.1.4 Test Procedure

The frequency and amplitude of the six highest ac power-line conducted emissions relative to the limit, measured over all the current-carrying conductors of the EUT power cords, and the operating frequency or frequency to which the EUT is tuned (if appropriate), should be reported, unless such emissions are more than 20 dB below the limit. AC power-line conducted emissions measurements are to be separately carried out only on each of the phase (“hot”) line(s) and (if used) on the neutral line(s), but not on the ground [protective earth] line(s). If less than six emission frequencies are within 20 dB of the limit, then the noise level of the measuring instrument at representative frequencies should be reported. The specific conductor of the power-line cord for each of the reported emissions should be identified. Measure the six highest emissions with respect to the limit on each current-carrying conductor of each power cord associated with the EUT (but not the power cords of associated or peripheral equipment that are part of the test configuration). Then, report the six highest emissions with respect to the limit from among all the measurements identifying the frequency and specific current-carrying conductor identified with the emission. The six highest emissions should be reported for each of the current-carrying conductors, or the six highest emissions may be reported over all the current-carrying conductors.

3.1.5 Corrected Amplitude & Margin Calculation

The basic equation is as follows:

Result = Reading + Factor

Factor = attenuation caused by cable loss + voltage division factor of AMN

The “**Margin**” column of the following data tables indicates the degree of compliance within the applicable limit. The equation for margin calculation is as follows:

Margin = Limit – Result

3.2 Radiation Spurious Emissions

3.2.1 Applicable Standard

FCC §15.247 (d);

In any 100 kHz bandwidth outside the frequency band in which the spread spectrum or digitally modulated intentional radiator is operating, the radio frequency power that is produced by the intentional radiator shall be at least 20 dB below that in the 100 kHz bandwidth within the band that contains the highest level of the desired power, based on either an RF conducted or a radiated measurement, provided the transmitter demonstrates compliance with the peak conducted power limits. If the transmitter complies with the conducted power limits based on the use of RMS averaging over a time interval, as permitted under paragraph (b)(3) of this section, the attenuation required under this paragraph shall be 30 dB instead of 20 dB. Attenuation below the general limits specified in §15.209(a) is not required. In addition, radiated emissions which fall in the restricted bands, as defined in §15.205(a), must also comply with the radiated emission limits specified in §15.209(a) (see §15.205(c)).

3.2.2 EUT Setup

Below 1GHz:

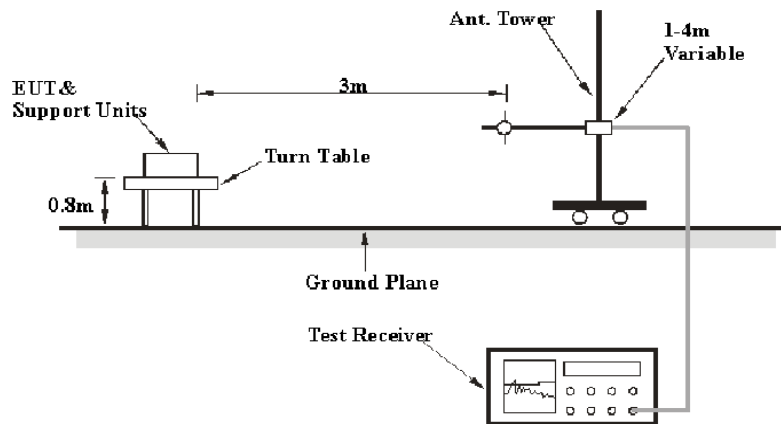

Above 1GHz:

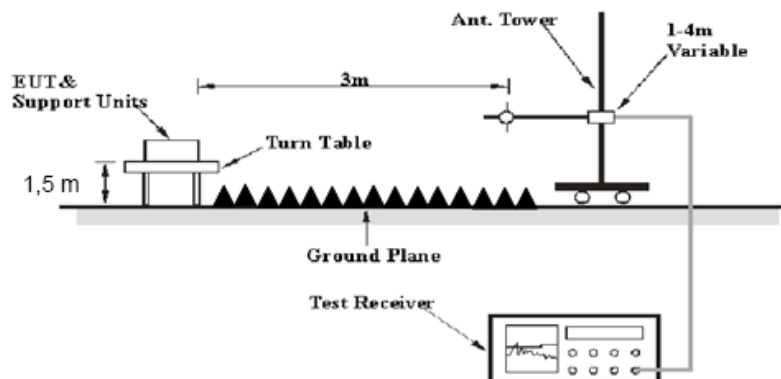

The radiated emissions were performed in the 3 meters distance, using the setup accordance with the ANSI C63.10-2013. The specification used was the FCC 15.209, and FCC 15.247 limits.

The external I/O cables were draped along the test table and formed a bundle 30 to 40 cm long in the middle.

The spacing between the peripherals was 10 cm.

3.2.3 EMI Test Receiver & Spectrum Analyzer Setup

The system was investigated from 30 MHz to 25 GHz.

During the radiated emission test, the EMI test receiver & Spectrum Analyzer Setup were set with the following configurations:

30MHz-1000MHz:

Measurement	RBW	Video B/W	IF B/W
QP	120 kHz	300 kHz	120kHz

1GHz- 25GHz:

Measurement	Duty cycle	RBW	Video B/W
PK	Any	1MHz	3 MHz
AV	>98%	1MHz	10 Hz
	<98%	1MHz	1/T

Note: T is minimum transmission duration

If the maximized peak measured value complies with under the QP/Average limit more than 6dB, then it is unnecessary to perform an QP/Average measurement.

3.2.4 Test Procedure

Maximizing procedure was performed on the highest emissions to ensure that the EUT complied with all installation combinations.

Data was recorded in Quasi-peak detection mode for frequency range of 30 MHz-1 GHz, peak and Average detection modes for frequencies above 1 GHz.

3.2.5 Corrected Amplitude & Margin Calculation

The basic equation is as follows:

Result = Reading + Factor

Factor = Antenna Factor + Cable Loss- Amplifier Gain

The “**Margin**” column of the following data tables indicates the degree of compliance within the applicable limit. The equation for margin calculation is as follows:

Margin = Limit – Result

3.3 6 dB Emission Bandwidth:

3.3.1 Applicable Standard

FCC §15.247 (a)(2)

Systems using digital modulation techniques may operate in the 902-928 MHz, 2400-2483.5 MHz, and 5725-5850 MHz bands. The minimum 6 dB bandwidth shall be at least 500 kHz.

3.3.2 EUT Setup

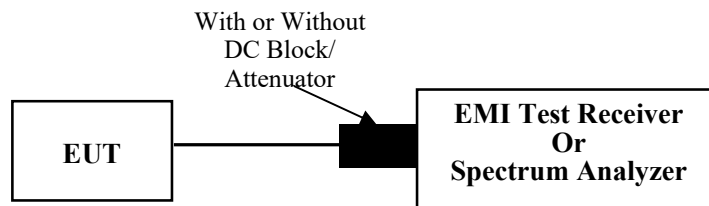

3.3.3 Test Procedure

According to ANSI C63.10-2013 Section 11.8

- a) Set RBW = 100 kHz.
- b) Set the video bandwidth (VBW) $\geq 3 \times$ RBW.
- c) Detector = Peak.
- d) Trace mode = max hold.
- e) Sweep = auto couple.
- f) Allow the trace to stabilize.
- g) Measure the maximum width of the emission that is constrained by the frequencies associated with the two outermost amplitude points (upper and lower frequencies) that are attenuated by 6 dB relative to the maximum level measured in the fundamental emission.

3.4 Maximum peak conducted output power:

3.4.1 Applicable Standard

FCC §15.247 (b)(3)

For systems using digital modulation in the 902-928 MHz, 2400-2483.5 MHz, and 5725-5850 MHz bands: 1 Watt. As an alternative to a peak power measurement, compliance with the one Watt limit can be based on a measurement of the maximum conducted output power. Maximum Conducted Output Power is defined as the total transmit power delivered to all antennas and antenna elements averaged across all symbols in the signaling alphabet when the transmitter is operating at its maximum power control level. Power must be summed across all antennas and antenna elements. The average must not include any time intervals during which the transmitter is off or is transmitting at a reduced power level. If multiple modes of operation are possible (e.g., alternative modulation methods), the maximum conducted output power is the highest total transmit power occurring in any mode.

3.4.2 EUT Setup

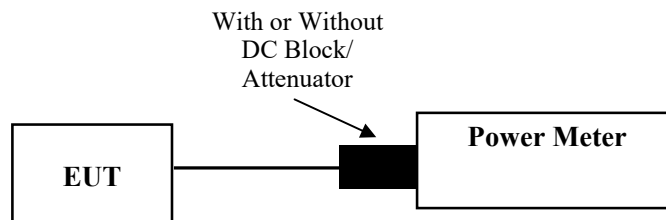

3.4.3 Test Procedure

According to ANSI C63.10-2013 Section 11.9.1.3

The maximum peak conducted output power may be measured using a broadband peak RF power meter. The power meter shall have a video bandwidth that is greater than or equal to the DTS bandwidth and shall use a fast-responding diode detector.

- a) Set the EUT in transmitting mode.
- b) Remove the antenna from the EUT and then connect a low loss RF cable from the antenna port to test equipment.
- c) Add a correction factor to the display.
- d) Set the power meter to test peak output power, record the result.

3.5 Maximum power spectral density:

3.5.1 Applicable Standard

FCC §15.247 (e)

For digitally modulated systems, the power spectral density conducted from the intentional radiator to the antenna shall not be greater than 8 dBm in any 3 kHz band during any time interval of continuous transmission. This power spectral density shall be determined in accordance with the provisions of paragraph (b) of this section. The same method of determining the conducted output power shall be used to determine the power spectral density.

3.5.2 EUT Setup

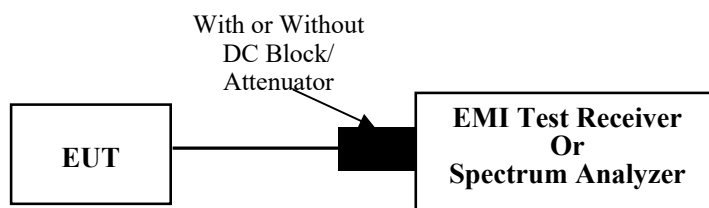

3.5.3 Test Procedure

According to ANSI C63.10-2013 Section 11.10.2

- a) Set analyzer center frequency to DTS channel center frequency.
- b) Set the span to 1.5 times the DTS bandwidth.
- c) Set the RBW to $3 \text{ kHz} \leq \text{RBW} \leq 100 \text{ kHz}$.
- d) Set the VBW $\geq [3 \cdot \text{RBW}]$.
- e) Detector = peak.
- f) Sweep time = auto couple.
- g) Trace mode = max hold.
- h) Allow trace to fully stabilize.
- i) Use the peak marker function to determine the maximum amplitude level within the RBW.
- j) If measured value exceeds requirement, then reduce RBW (but no less than 3 kHz) and repeat.

3.6 100 kHz Bandwidth of Frequency Band Edge:

3.6.1 Applicable Standard

FCC §15.247 (d);

In any 100 kHz bandwidth outside the frequency band in which the spread spectrum or digitally modulated intentional radiator is operating, the radio frequency power that is produced by the intentional radiator shall be at least 20 dB below that in the 100 kHz bandwidth within the band that contains the highest level of the desired power, based on either an RF conducted or a radiated measurement, provided the transmitter demonstrates compliance with the peak conducted power limits. If the transmitter complies with the conducted power limits based on the use of RMS averaging over a time interval, as permitted under paragraph (b)(3) of this section, the attenuation required under this paragraph shall be 30 dB instead of 20 dB. Attenuation below the general limits specified in §15.209(a) is not required. In addition, radiated emissions which fall in the restricted bands, as defined in §15.205(a), must also comply with the radiated emission limits specified in §15.209(a) (see §15.205(c)).

3.6.2 EUT Setup

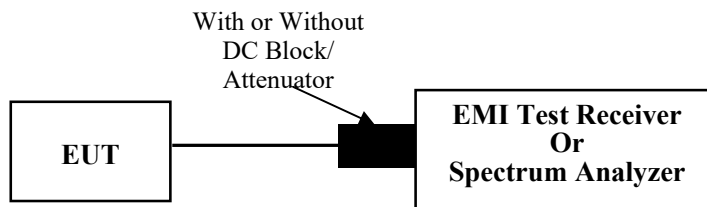

3.6.3 Test Procedure

According to ANSI C63.10-2013 Section 11.11

- a) Set the center frequency and span to encompass frequency range to be measured.
- b) Set the RBW = 100 kHz.
- c) Set the VBW $\geq [3 \times \text{RBW}]$.
- d) Detector = peak.
- e) Sweep time = auto couple.
- f) Trace mode = max hold.
- g) Allow trace to fully stabilize.
- h) Use the peak marker function to determine the maximum amplitude level.

Ensure that the amplitude of all unwanted emissions outside of the authorized frequency band (excluding restricted frequency bands) is attenuated by at least the minimum requirements specified in 11.11. Report the three highest emissions relative to the limit.

3.7 Duty Cycle:

3.7.1 EUT Setup

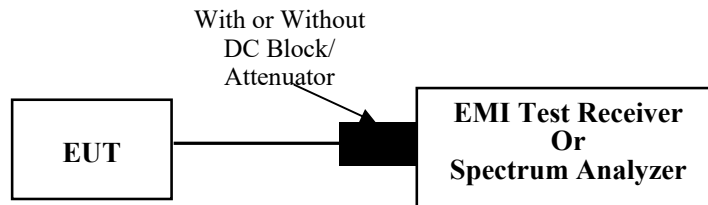

3.7.2 Test Procedure

According to ANSI C63.10-2013 Section 11.6

The zero-span mode on a spectrum analyzer or EMI receiver if the response time and spacing between bins on the sweep are sufficient to permit accurate measurements of the ON and OFF times of the transmitted signal:

- 1) Set the center frequency of the instrument to the center frequency of the transmission.
- 2) Set $RBW \geq OBW$ if possible; otherwise, set RBW to the largest available value.
- 3) Set $VBW \geq RBW$. Set detector = peak or average.
- 4) The zero-span measurement method shall not be used unless both RBW and VBW are $> 50/T$ and the number of sweep points across duration T exceeds 100. (For example, if VBW and/or RBW are limited to 3 MHz, then the zero-span method of measuring the duty cycle shall not be used if $T \leq 16.7 \mu s$.)

3.8 Antenna Requirement

3.8.1 Applicable Standard

FCC §15.203

An intentional radiator shall be designed to ensure that no antenna other than that furnished by the responsible party shall be used with the device. The use of a permanently attached antenna or of an antenna that uses a unique coupling to the intentional radiator shall be considered sufficient to comply with the provisions of this section. The manufacturer may design the unit so that a broken antenna can be replaced by the user, but the use of a standard antenna jack or electrical connector is prohibited. This requirement does not apply to carrier current devices or to devices operated under the provisions of §§15.211, 15.213, 15.217, 15.219, 15.221, or §15.236. Further, this requirement does not apply to intentional radiators that must be professionally installed, such as perimeter protection systems and some field disturbance sensors, or to other intentional radiators which, in accordance with §15.31(d), must be measured at the installation site. However, the installer shall be responsible for ensuring that the proper antenna is employed so that the limits in this part are not exceeded.

3.8.2 Judgment

Please refer to the Antenna Information detail in Section 1.

4. Test DATA AND RESULTS

4.1 AC Line Conducted Emissions

Serial Number:	CR22080062-RF-S1	Test Date:	2022/09/23
Test Site:	CE	Test Mode:	Transmitting
Tester:	Vic Du	Test Result:	Pass

Environmental Conditions:

Temperature: (°C)	27.5	Relative Humidity: (%)	60	ATM Pressure: (kPa)	101.2
----------------------	------	------------------------------	----	------------------------	-------

Test Equipment List and Details:

Manufacturer	Description	Model	Serial Number	Calibration Date	Calibration Due Date
R&S	LISN	ENV216	101134	2022/04/01	2023/03/31
R&S	EMI Test Receiver	ESR3	102726	2022/07/15	2023/07/14
MICRO-COAX	Coaxial Cable	UTIFLEX	C-0200-01	2022/08/07	2023/08/06
Audix	Test Software	E3	190306 (V9)	N/A	N/A

* Statement of Traceability: China Certification ICT Co., Ltd (Dongguan) attests that all calibrations have been performed, traceable to National Primary Standards and International System of Units (SI).

Line

Test Mode: Transmitting
 Port: Line
 Note:

Date: 2022-09-23

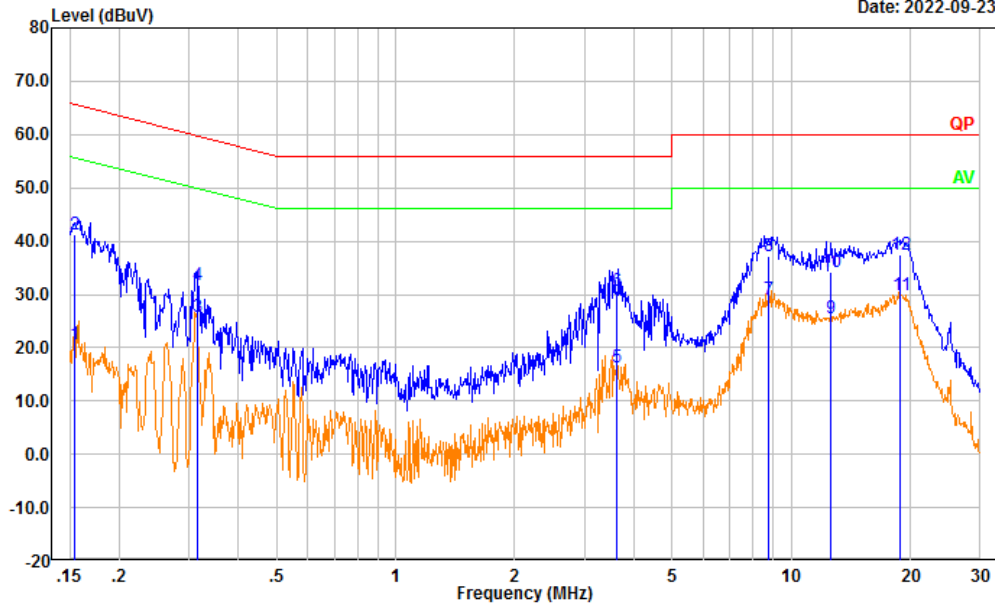

No.	Frequency (MHz)	Reading (dBμV)	Factor (dB)	Result (dBμV)	Limit (dBμV)	Margin (dB)	Detector
1	0.154	11.12	9.61	20.73	55.76	35.03	Average
2	0.154	31.57	9.61	41.18	65.76	24.58	QP
3	0.315	16.32	9.61	25.93	49.84	23.91	Average
4	0.315	22.11	9.61	31.72	59.84	28.12	QP
5	3.610	6.62	9.65	16.27	46.00	29.73	Average
6	3.610	21.04	9.65	30.69	56.00	25.31	QP
7	8.724	19.34	9.67	29.01	50.00	20.99	Average
8	8.724	27.58	9.67	37.25	60.00	22.75	QP
9	12.567	15.79	9.68	25.47	50.00	24.53	Average
10	12.567	24.61	9.68	34.29	60.00	25.71	QP
11	18.871	20.01	9.77	29.78	50.00	20.22	Average
12	18.871	27.67	9.77	37.44	60.00	22.56	QP

Neutral

Test Mode: Transmitting
 Port: neutral
 Note:

Date: 2022-09-23

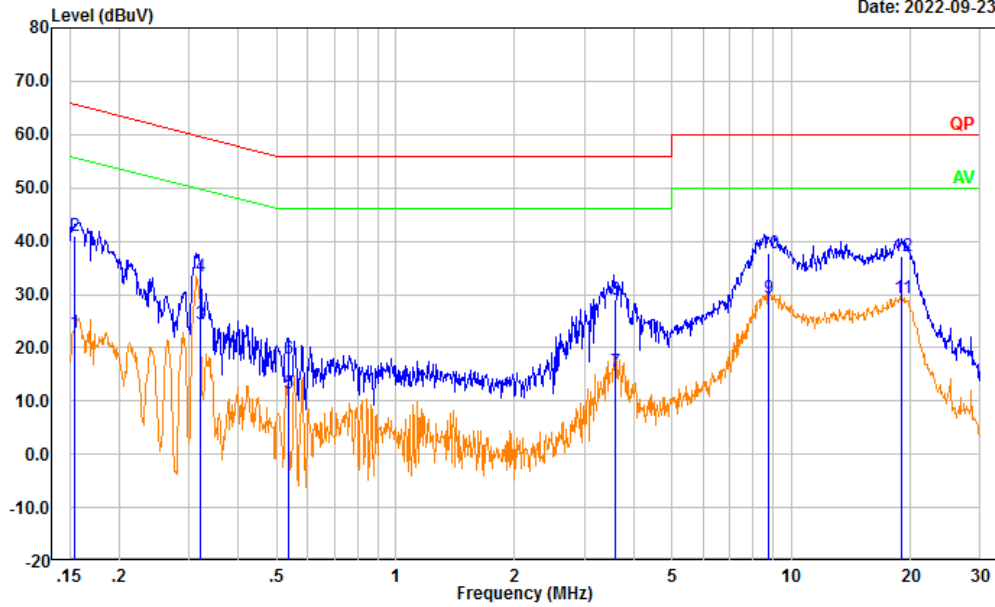

No.	Frequency (MHz)	Reading (dBμV)	Factor (dB)	Result (dBμV)	Limit (dBμV)	Margin (dB)	Detector
1	0.155	13.09	9.61	22.70	55.74	33.04	Average
2	0.155	31.33	9.61	40.94	65.74	24.80	QP
3	0.322	14.76	9.61	24.37	49.66	25.29	Average
4	0.322	23.69	9.61	33.30	59.66	26.36	QP
5	0.535	1.88	9.61	11.49	46.00	34.51	Average
6	0.535	8.28	9.61	17.89	56.00	38.11	QP
7	3.602	5.85	9.65	15.50	46.00	30.50	Average
8	3.602	19.40	9.65	29.05	56.00	26.95	QP
9	8.739	19.57	9.67	29.24	50.00	20.76	Average
10	8.739	27.97	9.67	37.64	60.00	22.36	QP
11	19.028	19.66	9.69	29.35	50.00	20.65	Average
12	19.028	27.37	9.69	37.06	60.00	22.94	QP

4.2 Radiation Spurious Emissions

Serial Number:	CR22080062-RF-S1	Test Date:	2022/09/23~2022/09/28
Test Site:	966-1, 966-2	Test Mode:	Transmitting
Tester:	Tommy Luo, Great Qiao	Test Result:	Pass

Environmental Conditions:

Temperature: (°C)	25.5~26.7	Relative Humidity: (%)	51~53	ATM Pressure: (kPa)	100.4~101.2
----------------------	-----------	------------------------------	-------	------------------------	-------------

Test Equipment List and Details:

Manufacturer	Description	Model	Serial Number	Calibration Date	Calibration Due Date
Sunol Sciences	Antenna	JB6	A082520-5	2020/10/19	2023/10/18
R&S	EMI Test Receiver	ESR3	102724	2022/07/15	2023/07/14
TIMES MICROWAVE	Coaxial Cable	LMR-600-UltraFlex	C-0470-02	2022/07/17	2023/07/16
TIMES MICROWAVE	Coaxial Cable	LMR-600-UltraFlex	C-0780-01	2022/07/17	2023/07/16
Sonoma	Amplifier	310N	186165	2022/07/17	2023/07/16
Audix	Test Software	E3	201021 (V9)	N/A	N/A
ETS-Lindgren	Horn Antenna	3115	9912-5985	2020/10/13	2023/10/12
R&S	Spectrum Analyzer	FSV40	101591	2022/07/15	2023/07/14
MICRO-COAX	Coaxial Cable	UFA210A-1-1200-70U300	217423-008	2022/08/07	2023/08/06
MICRO-COAX	Coaxial Cable	UFA210A-1-2362-300300	235780-001	2022/08/07	2023/08/06
Mini	Pre-amplifier	ZVA-183-S+	5969001149	2021/11/10	2022/11/09
PASTERNAK	Horn Antenna	PE9852/2F-20	112002	2021/02/05	2024/02/04
AH	Preamplifier	PAM-1840VH	190	2021/11/19	2022/11/18
MICRO-COAX	Coaxial Cable	UFB142A-1-2362-200200	235772-001	2022/08/07	2023/08/06
E-Microwave	Band Rejection Filter	2400-2483.5MHz	OE01902424	2022/08/07	2023/08/06
Mini Circuits	High Pass Filter	VHF-6010+	31119	2022/08/07	2023/08/06

* Statement of Traceability: China Certification ICT Co., Ltd (Dongguan) attests that all calibrations have been performed, traceable to National Primary Standards and International System of Units (SI).

**1) 30MHz-1GHz(1Mbps low channel was the worst)
Horizontal:**

Test Mode: Transmitting
Polarization: horizontal
Note:

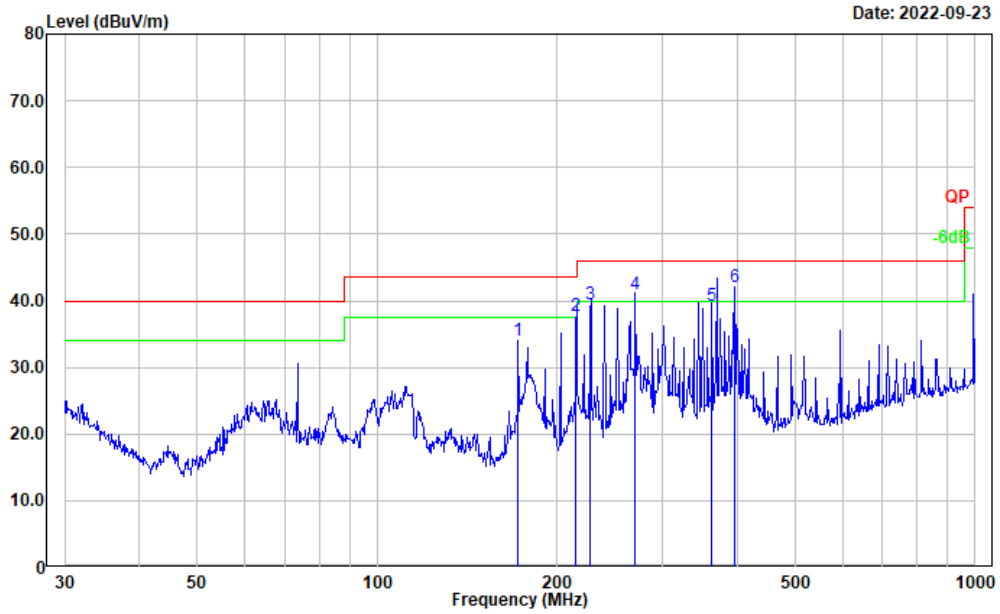

No.	Frequency (MHz)	Reading (dBμV)	Factor (dB/m)	Result (dBμV/m)	Limit (dBμV/m)	Margin (dB)	Detector
1	171.995	47.17	-13.05	34.12	43.50	9.38	Peak
2	215.018	50.28	-12.61	37.67	43.50	5.83	QP
3	227.336	52.43	-12.92	39.51	46.00	6.49	QP
4	270.331	53.07	-12.08	40.99	46.00	5.01	QP
5	362.482	49.06	-9.76	39.30	46.00	6.70	QP
6	396.068	50.80	-8.82	41.98	46.00	4.02	QP

Vertical:

Test Mode: Transmitting
 Polarization: vertical
 Note:

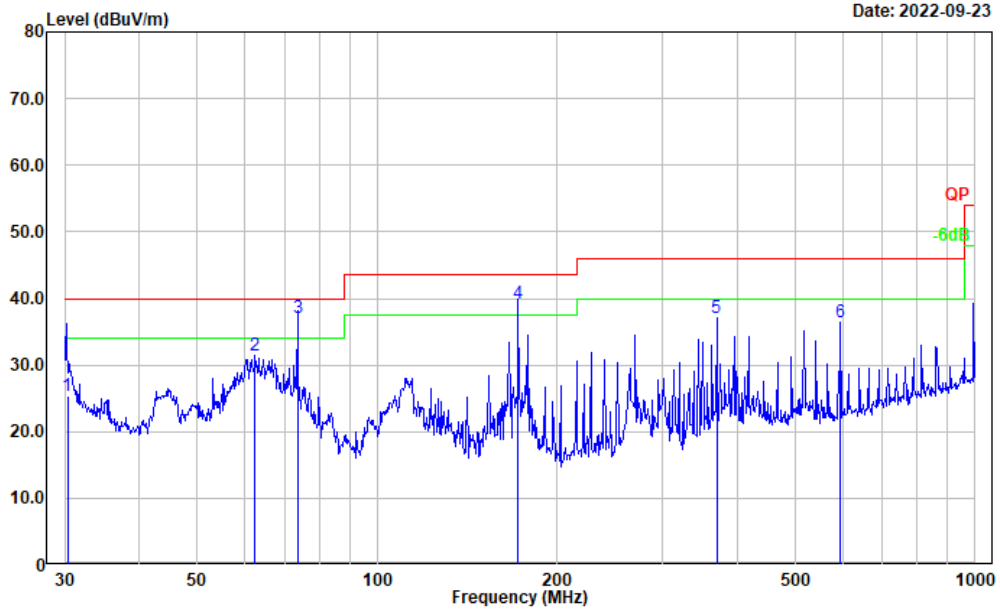

No.	Frequency (MHz)	Reading (dBμV)	Factor (dB/m)	Result (dBμV/m)	Limit (dBμV/m)	Margin (dB)	Detector
1	30.321	29.24	-3.85	25.39	40.00	14.61	QP
2	62.431	48.56	-17.19	31.37	40.00	8.63	Peak
3	73.726	53.92	-16.85	37.07	40.00	2.93	QP
4	172.029	52.22	-13.05	39.17	43.50	4.33	QP
5	369.405	46.56	-9.53	37.03	46.00	8.97	Peak
6	595.133	41.53	-5.15	36.38	46.00	9.62	Peak

2) 1-25GHz:

BLE, 1Mbps:

Frequency (MHz)	Receiver		Polar (H/V)	Factor (dB/m)	Result (dBµV/m)	Limit (dBµV/m)	Margin (dB)
	Reading (dBµV)	Detector					
Low Channel: 2402 MHz							
2402.00	64.38	PK	H	31.51	95.89	N/A	N/A
2402.00	60.01	AV	H	31.51	91.52	N/A	N/A
2402.00	58.21	PK	V	31.51	89.72	N/A	N/A
2402.00	60.95	AV	V	31.51	92.46	N/A	N/A
2390.00	24.36	PK	H	31.46	55.82	74.00	18.18
2390.00	12.57	AV	H	31.46	44.03	54.00	9.97
4804.00	43.06	PK	H	10.91	53.97	74.00	20.03
4804.00	31.03	AV	H	10.91	41.94	54.00	12.06
7206.00	37.34	PK	H	14.22	51.56	74.00	22.44
7206.00	25.17	AV	H	14.22	39.39	54.00	14.61
Middle Channel: 2440 MHz							
2440.00	65.11	PK	H	31.60	96.71	N/A	N/A
2440.00	63.15	AV	H	31.60	94.75	N/A	N/A
2440.00	60.47	PK	V	31.60	92.07	N/A	N/A
2440.00	58.34	AV	V	31.60	89.94	N/A	N/A
4880.00	43.49	PK	H	11.07	54.56	74.00	19.44
4880.00	31.25	AV	H	11.07	42.32	54.00	11.68
7320.00	36.97	PK	H	14.80	51.77	74.00	22.23
7320.00	24.50	AV	H	14.80	39.30	54.00	14.70
High Channel: 2480 MHz							
2480.00	65.24	PK	H	31.64	96.88	N/A	N/A
2480.00	63.45	AV	H	31.64	95.09	N/A	N/A
2480.00	60.21	PK	V	31.64	91.85	N/A	N/A
2480.00	58.34	AV	V	31.64	89.98	N/A	N/A
2483.50	26.15	PK	H	31.64	57.79	74.00	16.21
2483.50	14.36	AV	H	31.64	46.00	54.00	8.00
4960.00	43.40	PK	H	11.23	54.63	74.00	19.37
4960.00	31.20	AV	H	11.23	42.43	54.00	11.57
7440.00	36.56	PK	H	15.26	51.82	74.00	22.18
7440.00	24.33	AV	H	15.26	39.59	54.00	14.41

BLE, 2Mbps:

Frequency (MHz)	Receiver		Polar (H/V)	Factor (dB/m)	Result (dB μ V/m)	Limit (dB μ V/m)	Margin (dB)
	Reading (dB μ V)	Detector					
Low Channel: 2402 MHz							
2402.00	65.23	PK	H	31.51	96.74	N/A	N/A
2402.00	63.51	AV	H	31.51	95.02	N/A	N/A
2402.00	60.14	PK	V	31.51	91.65	N/A	N/A
2402.00	58.64	AV	V	31.51	90.15	N/A	N/A
2390.00	25.74	PK	H	31.46	57.20	74.00	16.80
2390.00	14.66	AV	H	31.46	46.12	54.00	7.88
4804.00	44.21	PK	H	10.91	55.12	74.00	18.88
4804.00	32.10	AV	H	10.91	43.01	54.00	10.99
7206.00	37.93	PK	H	14.22	52.15	74.00	21.85
7206.00	25.27	AV	H	14.22	39.49	54.00	14.51
Middle Channel: 2440 MHz							
2440.00	64.57	PK	H	31.60	96.17	N/A	N/A
2440.00	62.62	AV	H	31.60	94.22	N/A	N/A
2440.00	60.50	PK	V	31.60	92.10	N/A	N/A
2440.00	58.57	AV	V	31.60	90.17	N/A	N/A
4880.00	43.40	PK	H	11.07	54.47	74.00	19.53
4880.00	31.20	AV	H	11.07	42.27	54.00	11.73
7320.00	36.96	PK	H	14.80	51.76	74.00	22.24
7320.00	24.48	AV	H	14.80	39.28	54.00	14.72
High Channel: 2480 MHz							
2480.00	65.11	PK	H	31.64	96.75	N/A	N/A
2480.00	63.21	AV	H	31.64	94.85	N/A	N/A
2480.00	60.14	PK	V	31.64	91.78	N/A	N/A
2480.00	58.21	AV	V	31.64	89.85	N/A	N/A
2483.50	25.88	PK	H	31.64	57.52	74.00	16.48
2483.50	14.86	AV	H	31.64	46.50	54.00	7.50
4960.00	44.53	PK	H	11.23	55.76	74.00	18.24
4960.00	32.37	AV	H	11.23	43.60	54.00	10.40
7440.00	37.13	PK	H	15.26	52.39	74.00	21.61
7440.00	25.07	AV	H	15.26	40.33	54.00	13.67

Worst Test plots(2Mbps high channel was the worst)

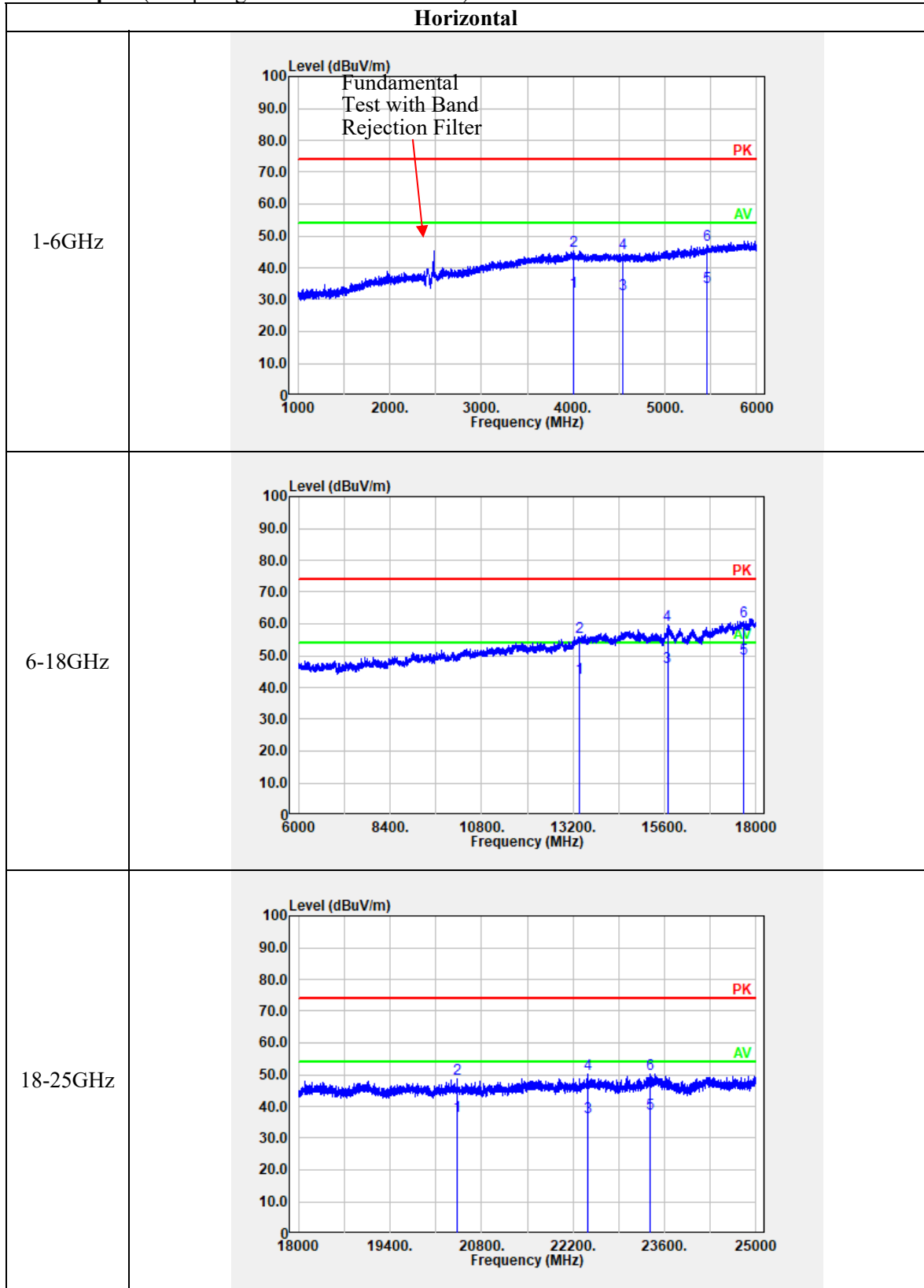

Vertical

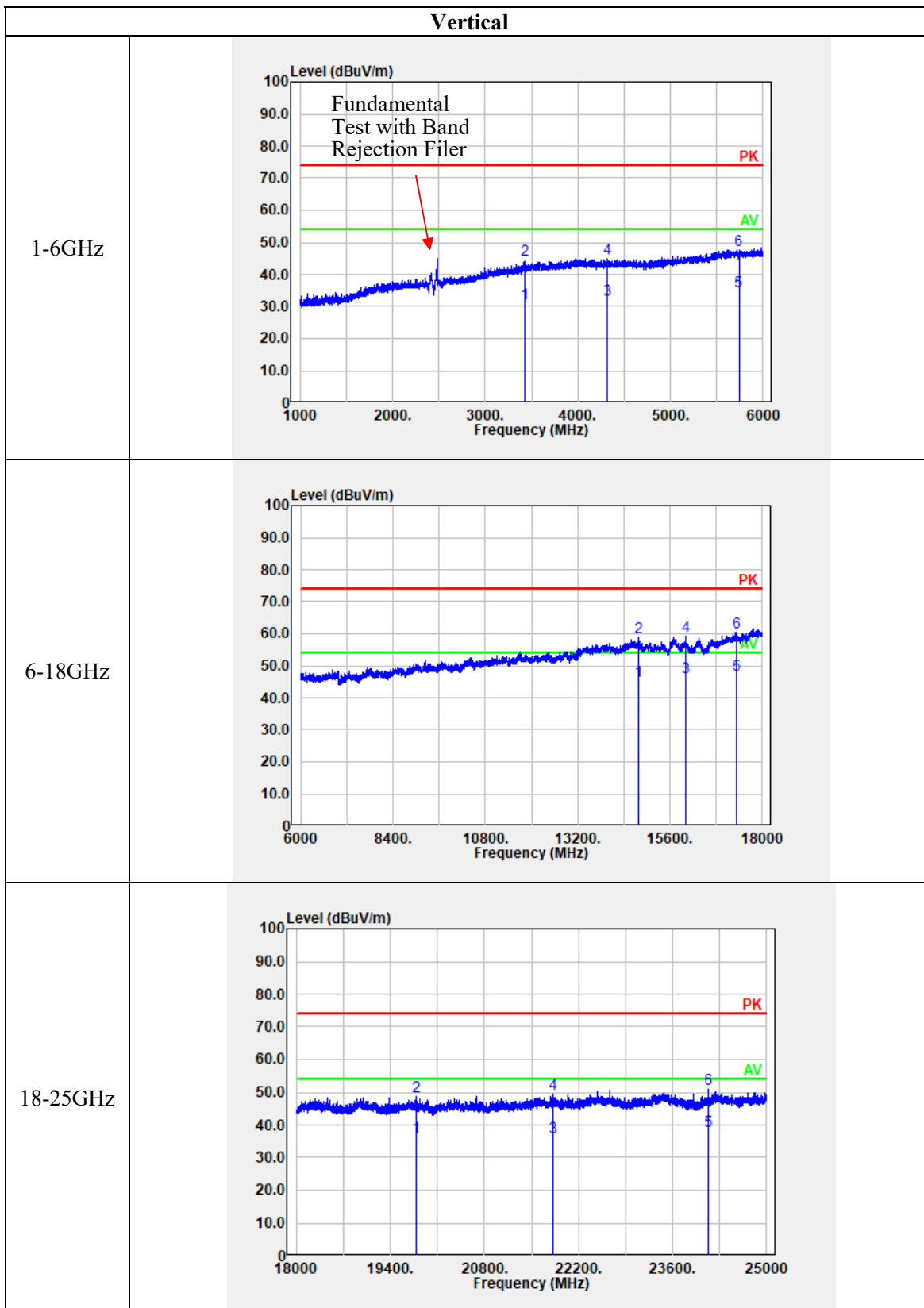

4.3 6 dB Emission Bandwidth:

Serial Number:	CR22080062-RF-S1	Test Date:	2022-09-13
Test Site:	RF	Test Mode:	Transmitting
Tester:	Morpheus Shi	Test Result:	Pass

Environmental Conditions:

Temperature: (°C)	26.6	Relative Humidity: (%)	55	ATM Pressure: (kPa)	100.2
----------------------	------	------------------------------	----	------------------------	-------

Test Equipment List and Details:

Manufacturer	Description	Model	Serial Number	Calibration Date	Calibration Due Date
R&S	Spectrum Analyzer	FSU26	200256	2022-07-15	2023-07-14
zhuoxiang	Coaxial Cable	SMA-178	211001	Each time	N/A
Mini-Circuits	DC Block	BLK-18-S+	1554403	2022-08-07	2023-08-06

* Statement of Traceability: China Certification ICT Co., Ltd (Dongguan) attests that all calibrations have been performed, traceable to National Primary Standards and International System of Units (SI).

Test Data:

Test Modes	Test Frequency (MHz)	6 dB Bandwidth (MHz)	Limit (MHz)
BLE 1Mbps	2402	0.716	≥ 0.5
	2440	0.720	≥ 0.5
	2480	0.712	≥ 0.5
BLE 2Mbps	2402	1.224	≥ 0.5
	2440	1.232	≥ 0.5
	2480	1.248	≥ 0.5

6dB Emission Bandwidth	
BLE 1Mbps Lowest Channel	<p style="text-align: center;">Date: 13.SEP.2022 22:45:43</p>
BLE 1Mbps Middle Channel	<p style="text-align: center;">Date: 13.SEP.2022 22:47:00</p>
BLE 1Mbps Highest Channel	<p style="text-align: center;">Date: 13.SEP.2022 22:48:04</p>

6dB Emission Bandwidth

BLE 2Mbps
Lowest Channel

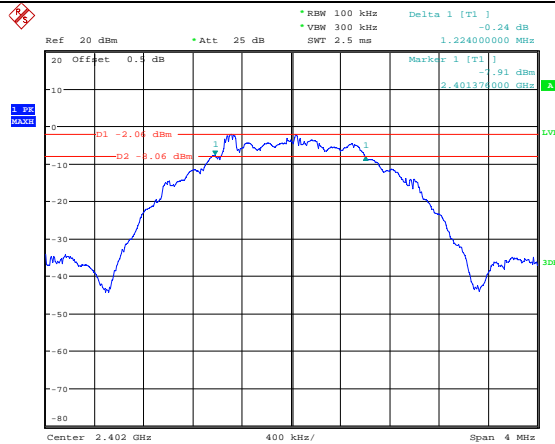

BLE 2Mbps
Middle Channel

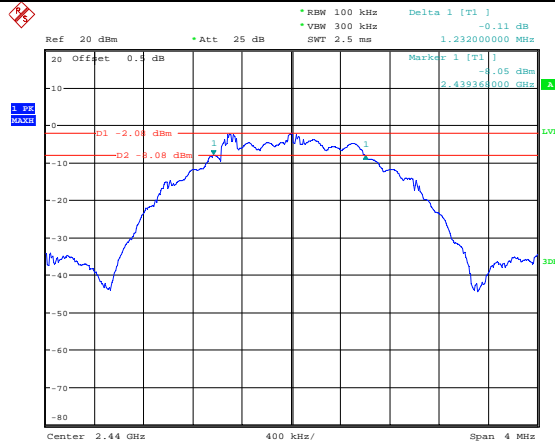

BLE 2Mbps
Highest Channel

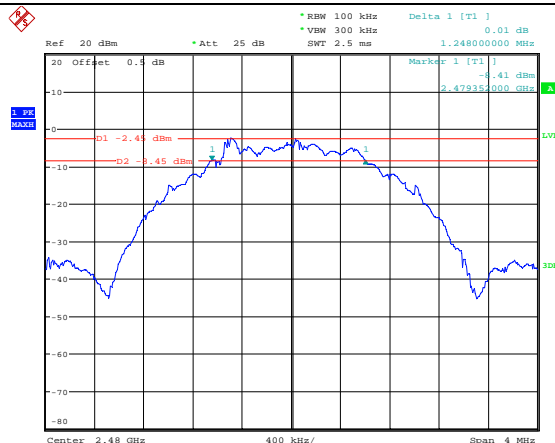

4.4 Maximum peak conducted output power:

Serial Number:	CR22080062-RF-S1	Test Date:	2022/9/13
Test Site:	RF	Test Mode:	Transmitting
Tester:	Morpheus Shi	Test Result:	Pass

Environmental Conditions:

Temperature: (°C)	26.6	Relative Humidity: (%)	55	ATM Pressure: (kPa)	100.2
----------------------	------	------------------------------	----	------------------------	-------

Test Equipment List and Details:

Manufacturer	Description	Model	Serial Number	Calibration Date	Calibration Due Date
Agilent	USB Wideband Power Sensor	U2021XA	MY54080015	2022-07-15	2023-07-14
zhuoxiang	Coaxial Cable	SMA-178	211001	Each time	N/A
Mini-Circuits	DC Block	BLK-18-S+	1554403	2022-08-07	2023-08-06

* Statement of Traceability: China Certification ICT Co., Ltd (Dongguan) attests that all calibrations have been performed, traceable to National Primary Standards and International System of Units (SI).

Test Data:

Test Modes	Test Frequency (MHz)	Maximum Conducted Peak Output Power (dBm)	Limit (dBm)
BLE 1Mbps	2402	0.03	≤30
	2440	-0.10	≤30
	2480	-0.27	≤30
BLE 2Mbps	2402	-0.13	≤30
	2440	-0.33	≤30
	2480	-0.49	≤30

4.5 Maximum power spectral density:

Serial Number:	CR22080062-RF-S1	Test Date:	2022-09-13
Test Site:	RF	Test Mode:	Transmitting
Tester:	Morpheus Shi	Test Result:	Pass

Environmental Conditions:

Temperature: (°C)	26.6	Relative Humidity: (%)	55	ATM Pressure: (kPa)	100.2
----------------------	------	------------------------------	----	------------------------	-------

Test Equipment List and Details:

Manufacturer	Description	Model	Serial Number	Calibration Date	Calibration Due Date
R&S	Spectrum Analyzer	FSU26	200256	2022-07-15	2023-07-14
zhuoxiang	Coaxial Cable	SMA-178	211001	Each time	N/A
Mini-Circuits	DC Block	BLK-18-S+	1554403	2022-08-07	2023-08-06

* Statement of Traceability: China Certification ICT Co., Ltd (Dongguan) attests that all calibrations have been performed, traceable to National Primary Standards and International System of Units (SI).

Test Data:

Test Modes	Test Frequency (MHz)	Power Spectral Density (dBm/3kHz)	Limit (dBm/3kHz)
BLE 1Mbps	2402	-16.11	≤8.00
	2440	-16.18	≤8.00
	2480	-16.57	≤8.00
BLE 2Mbps	2402	-19.50	≤8.00
	2440	-19.99	≤8.00
	2480	-20.01	≤8.00

Maximum power spectral density

<p>BLE 1Mbps Lowest Channel</p>	<p>Ref: 20 dBm *Att: 25 dB *RBW: 3 kHz Marker 1 [T1] -16.11 dBm *VBW: 10 kHz *SWT: 120 ms 2.402088069 GHz</p> <p>Center: 2.402 GHz 107.4 kHz/ Span: 1.074 MHz</p> <p>Date: 13.SEP.2022 22:46:19</p>
<p>BLE 1Mbps Middle Channel</p>	<p>Ref: 20 dBm *Att: 25 dB *RBW: 3 kHz Marker 1 [T1] -16.18 dBm *VBW: 10 kHz *SWT: 120 ms 2.440090720 GHz</p> <p>Center: 2.44 GHz 108 kHz/ Span: 1.08 MHz</p> <p>Date: 13.SEP.2022 22:47:40</p>
<p>BLE 1Mbps Highest Channel</p>	<p>Ref: 20 dBm *Att: 25 dB *RBW: 3 kHz Marker 1 [T1] -16.57 dBm *VBW: 10 kHz *SWT: 120 ms 2.480087576 GHz</p> <p>Center: 2.48 GHz 106.8 kHz/ Span: 1.068 MHz</p> <p>Date: 13.SEP.2022 22:48:41</p>

Maximum power spectral density

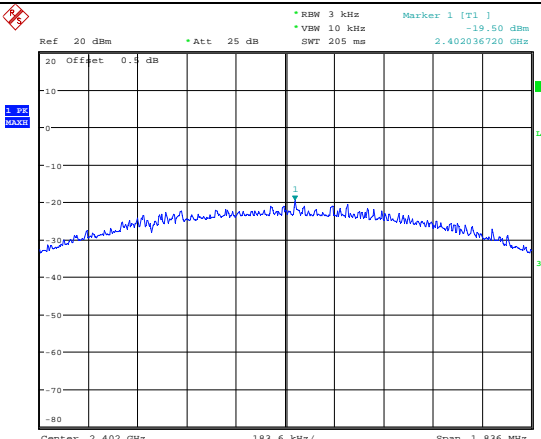
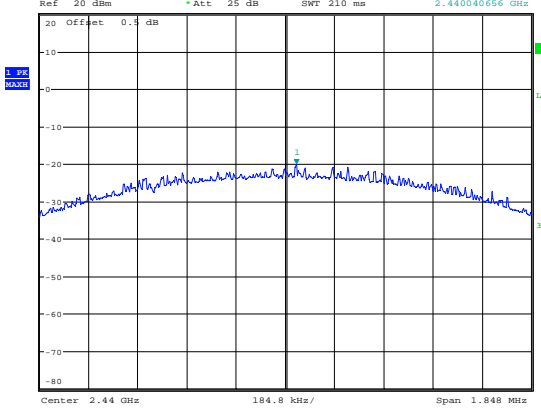
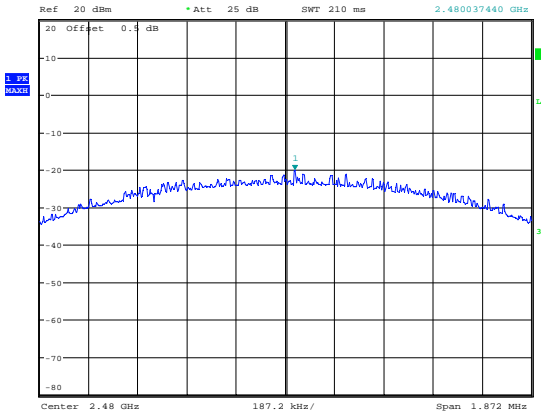
<p>BLE 2Mbps Lowest Channel</p>	 <p>Ref: 20 dBm, Att: 25 dB, RBW: 3 kHz, VBW: 10 kHz, SWT: 205 ms, Marker 1 [T1]: -19.50 dBm, 2.402036720 GHz</p> <p>Center: 2.402 GHz, Span: 1.836 MHz</p> <p>Date: 13.SEP.2022 22:50:06</p>
<p>BLE 2Mbps Middle Channel</p>	 <p>Ref: 20 dBm, Att: 25 dB, RBW: 3 kHz, VBW: 10 kHz, SWT: 210 ms, Marker 1 [T1]: -19.99 dBm, 2.440040656 GHz</p> <p>Center: 2.44 GHz, Span: 1.848 MHz</p> <p>Date: 13.SEP.2022 22:51:20</p>
<p>BLE 2Mbps Highest Channel</p>	 <p>Ref: 20 dBm, Att: 25 dB, RBW: 3 kHz, VBW: 10 kHz, SWT: 210 ms, Marker 1 [T1]: -20.01 dBm, 2.480037440 GHz</p> <p>Center: 2.48 GHz, Span: 1.872 MHz</p> <p>Date: 13.SEP.2022 22:52:22</p>

4.6 100 kHz Bandwidth of Frequency Band Edge:

Serial Number:	CR22080062-RF-S1	Test Date:	2022-09-13
Test Site:	RF	Test Mode:	Transmitting
Tester:	Morpheus Shi	Test Result:	Pass

Environmental Conditions:

Temperature: (°C)	26.6	Relative Humidity: (%)	55	ATM Pressure: (kPa)	100.2
----------------------	------	------------------------------	----	------------------------	-------

Test Equipment List and Details:

Manufacturer	Description	Model	Serial Number	Calibration Date	Calibration Due Date
R&S	Spectrum Analyzer	FSU26	200256	2022-07-15	2023-07-14
zhuoxiang	Coaxial Cable	SMA-178	211001	Each time	N/A
Mini-Circuits	DC Block	BLK-18-S+	1554403	2022-08-07	2023-08-06

* Statement of Traceability: China Certification ICT Co., Ltd (Dongguan) attests that all calibrations have been performed, traceable to National Primary Standards and International System of Units (SI).

100 kHz Bandwidth of Frequency Band Edge

BLE 1Mbps
Lowest Band edge

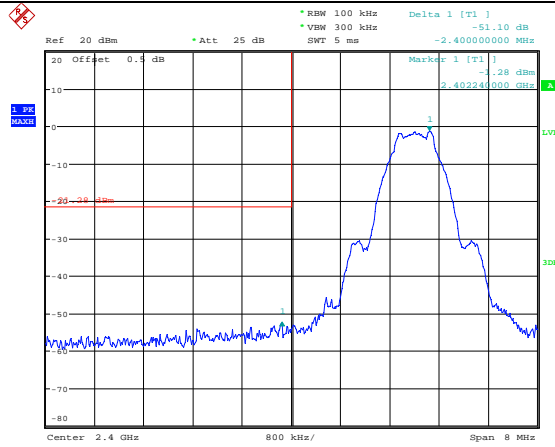

BLE 1Mbps
Highest Band edge

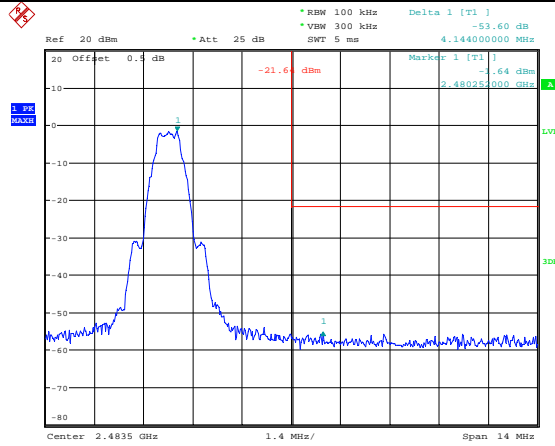

100 kHz Bandwidth of Frequency Band Edge

BLE 2Mbps
Lowest Band edge

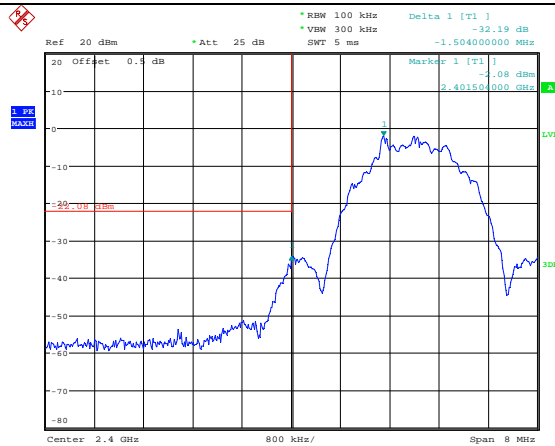

Date: 13.SEP.2022 22:50:19

BLE 2Mbps
Highest Band edge

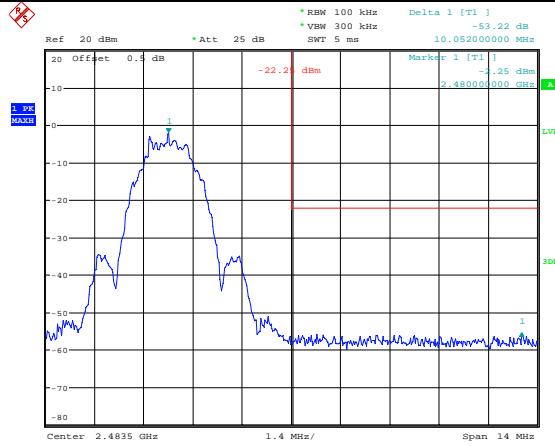

Date: 13.SEP.2022 22:52:38

4.7 Duty Cycle:

Serial Number:	CR22080062-RF-S1	Test Date:	2022-09-13
Test Site:	RF	Test Mode:	Transmitting
Tester:	Morpheus Shi	Test Result:	N/A

Environmental Conditions:

Temperature: (°C)	26.6	Relative Humidity: (%)	55	ATM Pressure: (kPa)	100.2
----------------------	------	------------------------------	----	------------------------	-------

Test Equipment List and Details:

Manufacturer	Description	Model	Serial Number	Calibration Date	Calibration Due Date
R&S	Spectrum Analyzer	FSU26	200256	2022-07-15	2023-07-14
zhuoxiang	Coaxial Cable	SMA-178	211001	Each time	N/A
Mini-Circuits	DC Block	BLK-18-S+	1554403	2022-08-07	2023-08-06

* Statement of Traceability: China Certification ICT Co., Ltd (Dongguan) attests that all calibrations have been performed, traceable to National Primary Standards and International System of Units (SI).

Test Data:

Test Modes	Ton (ms)	Ton+off (ms)	Duty cycle (%)
BLE 1Mbps	2.175	2.513	86.55
BLE 2Mbps	1.148	1.276	89.97

Duty Cycle

BLE 1Mbps

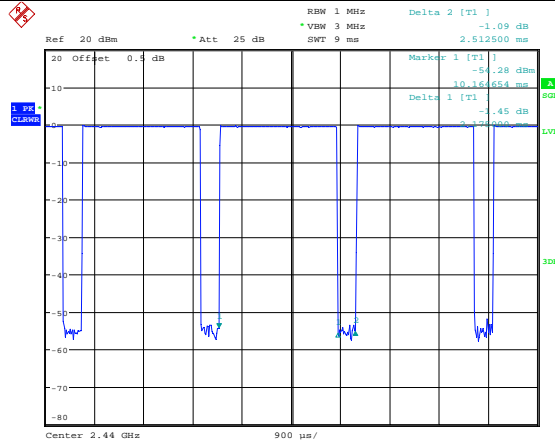

Date: 13.SEP.2022 22:56:34

BLE 2Mbps

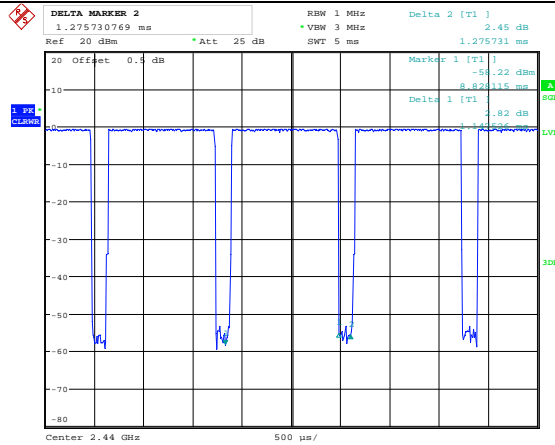

Date: 13.SEP.2022 22:58:37

5. RF EXPOSURE EVALUATION

5.1 Applicable Standard

FCC §15.247 (i)

Systems operating under the provisions of this section shall be operated in a manner that ensures that the public is not exposed to radio frequency energy levels in excess of the Commission's guidelines. See §1.1307(b)(1) of this chapter.

5.2 Procedure

According to §1.1307(b)(3)(i)

(C) Or using Table 1 and the minimum separation distance (R in meters) from the body of a nearby person for the frequency (f in MHz) at which the source operates, the ERP (watts) is no more than the calculated value prescribed for that frequency. For the exemption in Table 1 to apply, R must be at least $\lambda/2\pi$, where λ is the free-space operating wavelength in meters. If the ERP of a single RF source is not easily obtained, then the available maximum time-averaged power may be used in lieu of ERP if the physical dimensions of the radiating structure(s) do not exceed the electrical length of $\lambda/4$ or if the antenna gain is less than that of a half-wave dipole (1.64 linear value).

Table 1 to § 1.1307(b)(3)(i)(C) - Single RF Sources Subject to Routine Environmental Evaluation

RF Source frequency (MHz)	Threshold ERP (watts)
0.3-1.34	$1,920 R^2$.
1.34-30	$3,450 R^2/f^2$.
30-300	$3.83 R^2$.
300-1,500	$0.0128 R^2f$.
1,500-100,000	$19.2R^2$.

5.3 Measurement Result

Radio	Frequency (MHz)	$\lambda/2\pi$ (mm)	Distance (mm)	Exemption ERP (mW)	Maximum Conducted Power including Tune-up Tolerance (dBm)	Antenna Gain (dBi)	ERP		MPE-Based Exemption
							dBm	mW	
BDR/EDR	2402-2480	19.88	200	768	2	1.54	1.39	1.38	Compliant
BLE	2402-2480	19.88	200	768	1	1.54	0.39	1.09	Compliant

Result: The device compliant the MPE-Based Exemption at 20cm distances.

===== END OF REPORT =====