

NUX
NUX Drum System

DM-8 DIGITAL DRUM KIT

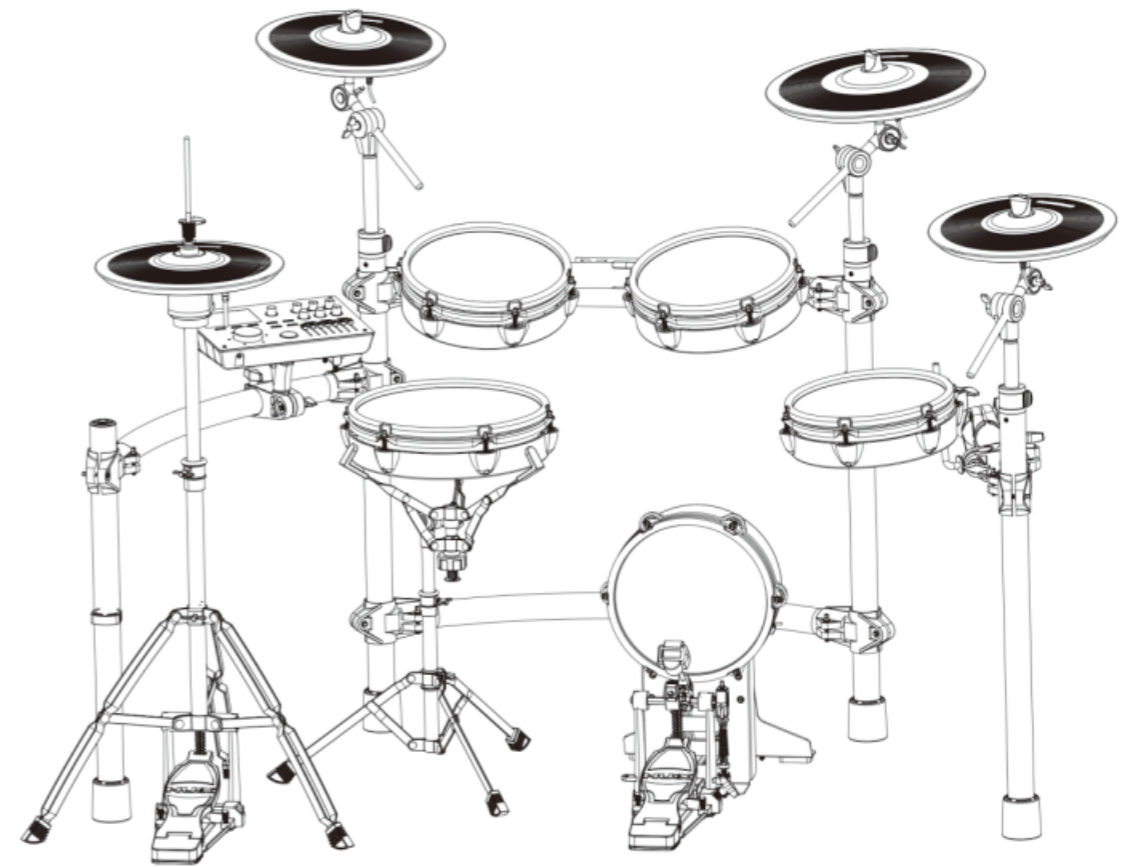

User Manual

© Cherub Technology Co., Ltd.

Version 1.0

All Rights Reserved. No part of this publication may be reproduced, stored in a retrieval system, or transmitted, in any form or by any means, electronic, mechanical, photocopying, recording, or otherwise, without the prior written permission of Cherub Technology Co., Ltd.

USING THE UNIT SAFELY

INSTRUCTIONS FOR THE PREVENTION OF FIRE, ELECTRIC SHOCK, OR INJURY TO PERSONS

About ⚠️ WARNING and ⚠️ CAUTION Notices

⚠️ WARNING	Used for instructions intended to alert the user to the risk of death or severe injury should the unit be used improperly.
-------------------	--

About the Symbol

⚠️ CAUTION	Used for instructions intended to alert the user to the risk of injury or material damage should the unit be used improperly. * Material damage refers to damage or other adverse effects caused with respect to the home and all its furnishings, as well to domestic animals or pets.
-------------------	--

ALWAYS OBSERVE THE FOLLOWING

⚠️ WARNING

- Before using this unit, make sure to read the instructions below and the Owner's Manual.
- Do not open (or modify in any way) the unit or its AC adaptor.
- Do not attempt to repair the unit, or replace parts within it (except when this manual provides specific instructions directing you to do so). Refer all servicing to your retailer, the nearest NUX Service Center.
- Never use or store the unit in places that are:
 - Subject to temperature extremes (e.g., direct sunlight in an enclosed vehicle, near a heating duct, on top of heat-generating equipment).
 - Damp (e.g., baths, washrooms, on wet floors).
 - Humid.
 - Exposed to rain.
 - Dusty.
 - Subject to high levels of vibration.
- This unit may be installed on stand using a Clamp.
- When installing the unit on a stand with a clamp, the stand must not be placed in an unstable location or on an incline, but in a level and stable position. Even if a stand is not used, make sure that the unit is placed in a stable location.

⚠️ WARNING

- Be sure to use only the AC adaptor supplied with the unit. Also, make sure the line voltage at the installation matches the input voltage specified on the AC adaptor's body. Other AC adaptors may use a different polarity, or be designed for a different voltage, so their use could result in damage, malfunction, or electric shock.
- Do not excessively twist or bend the power cord, nor place heavy objects on it. Doing so can damage the cord, producing severed elements and short circuits. Damaged cords are fire and shock Hazards!
- This unit, either alone or in combination with an amplifier and headphones or speakers, may be capable of producing sound levels that could cause permanent hearing loss. Do not operate for a long period of time at a high volume level, or at a level that is uncomfortable. If you experience any hearing loss or ringing in the ears, you should immediately stop using the unit, and consult an Audiologist.
- Do not allow any objects (e.g., flammable material, coins, pins); or liquids of any kind (water, soft drinks, etc.) to penetrate the unit.

⚠️ WARNING

- Immediately turn the power off, remove the AC adaptor from the outlet, and request servicing by your retailer, the nearest NUX Service Center.
 - The AC adaptor or the power-supply cord has been damaged.
 - If smoke or an unusual odor occurs.
 - Objects have fallen into, or liquid has been spilled onto the unit.
 - The unit has been exposed to rain (or otherwise has become wet).
 - The unit does not appear to operate normally or exhibits a marked change in performance.

- In households with small children, an adult should provide supervision until the child is capable of following all the rules essential for the safe operation of the unit.

- Protect the unit from strong impact. (Do not drop it!)

- Do not force the unit's power-supply cord to share an outlet with an unreasonable number of other devices. Be especially careful when using extension cords-the total power used by all devices you have connected to the extension cord's outlet must never exceed the power rating (watts/amperes) for the extension cord. Excessive loads can cause the insulation on the cord to heat up and eventually melt through.

- Before using the unit in a foreign country, consult with your retailer, the nearest NUX Service Center.

⚠️ CAUTION

- The unit and the AC adaptor should be located so their location or position does not interfere with their proper ventilation.

- Always grasp only the output plug or the body of the AC adaptor when plugging into, or unplugging from, this unit or an outlet.

- Any accumulation of dust between the AC adaptor and the power outlet can result in poor insulation and lead to fire. Periodically wipe away such dust with a dry cloth. Also, disconnect the power plug from the power outlet whenever the unit is to remain unused for an extended period of time.

- Try to prevent cords and cables from becoming entangled. Also, all cords and cables should be placed so they are out of the reach of children.

- Never climb on top of, nor place heavy objects on the unit.

- Never handle the AC adaptor body, or its output plugs, with wet hands when plugging into, or unplugging from, an outlet or this unit.

- If you need to move the instrument, take note of the precautions listed below. Make sure to have a firm grip, to protect yourself from injury and the instrument from damage.
 - Check to make sure that the clamp that fixes the unit to the stand has not become loose. Fasten them again securely whenever you notice any loosening.
 - Disconnect the power cord.
 - Disconnect all cords coming from external devices.

- Before cleaning the unit, turn off the power and unplug the AC adaptor from the outlet.

- Whenever you suspect the possibility of lightning in your area, disconnect the AC adaptor from the outlet.

- Should you remove security screws, make sure to put them in a safe place out of children's reach, so there is no chance of them being swallowed accidentally.

Quick installation guide

Unit

1



Left straight tube 650 x 1

2



Right straight tube 700 x 1

3



Left straight tube 800 x 1

4



Right straight tube 800 x 1

5

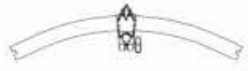

Left curve tube 650 x 1

6



Right curve tube 650 x 1

7



Top curve tube 750 x 1

8



Bottom curve tube 750 x 1

9



Cymbal boom arm x 3

10



Tom hold x 3

11



Hi-hat stand x 1

12



Snare stand x 1

13



Module x 1

14



NCY-12
12" cymbal x 2

15



NRC-14C
14" cymbal x 1

16



Hi-hat cymbal x 1

17

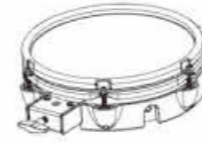

10" mesh drum pad x 3

18



12" mesh drum pad x 1

19

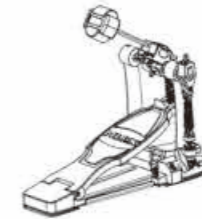

Kick pedal x 1

20



Kick drum x 1

21



Hi-hat control x 1

22



Cable locker x 6

23

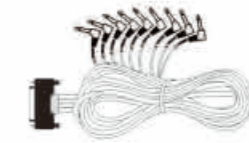

Cable x 1

24



Power adapter x 1

Quick installation guide

Quick installation guide

Install

1. Install the drum rack

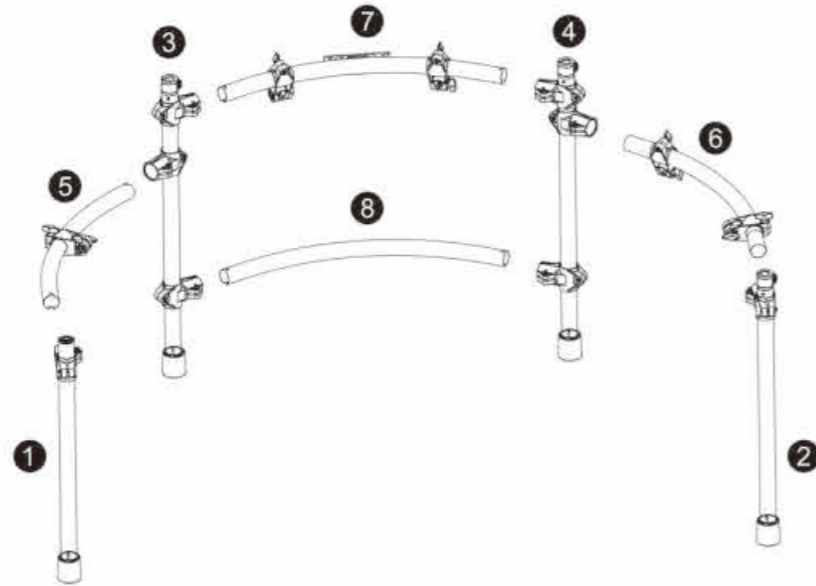

2. Install the cymbal arm and drum holder

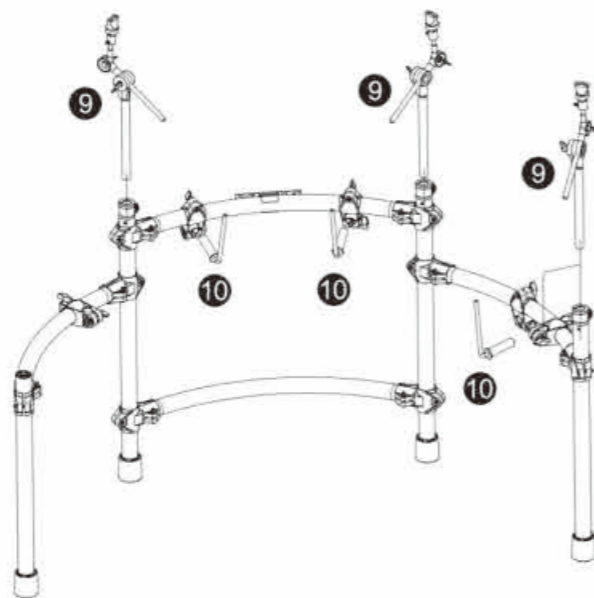

Quick installation guide

3. Install the drum pads and cymbals

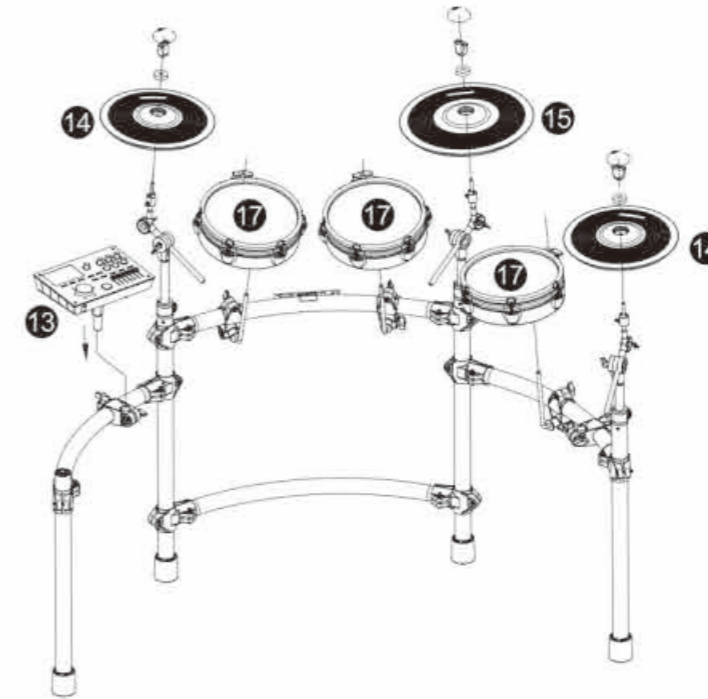

4. Install the hi-hat, snare, kick

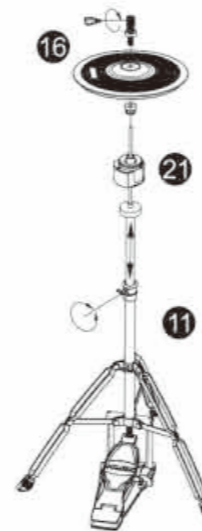

Install the hi-hat

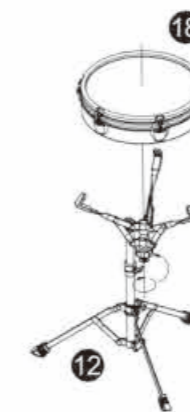

Install the snare

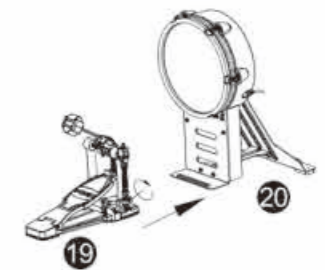

Install the kick and kick pedal

Quick installation guide

5. Connect the cables

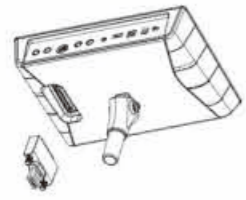

Module



Tom



Snare

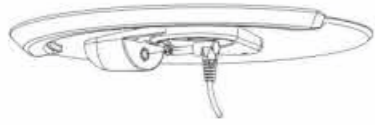

Cymbal



Hi-hat Control



Kick

6. Ready to go!

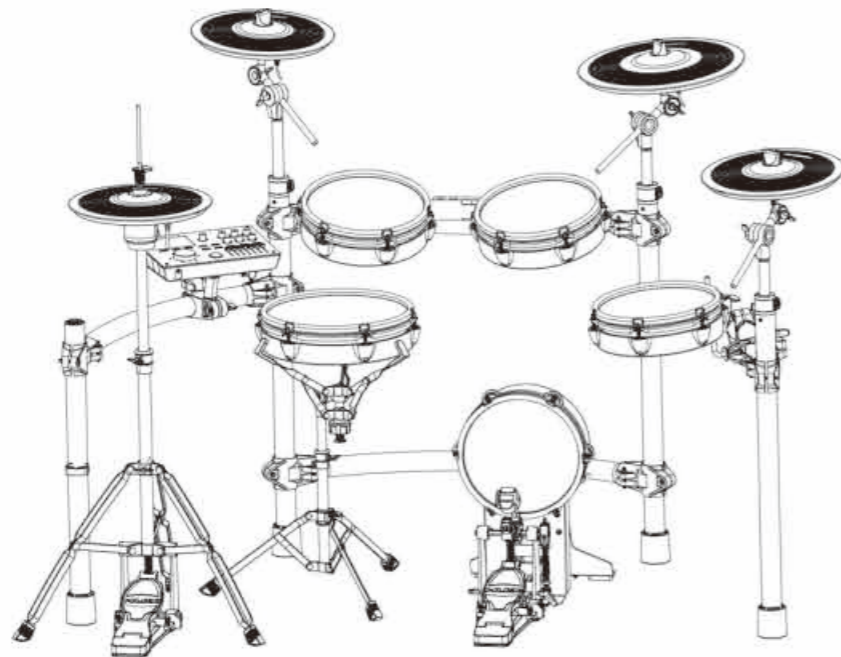

Quick installation guide

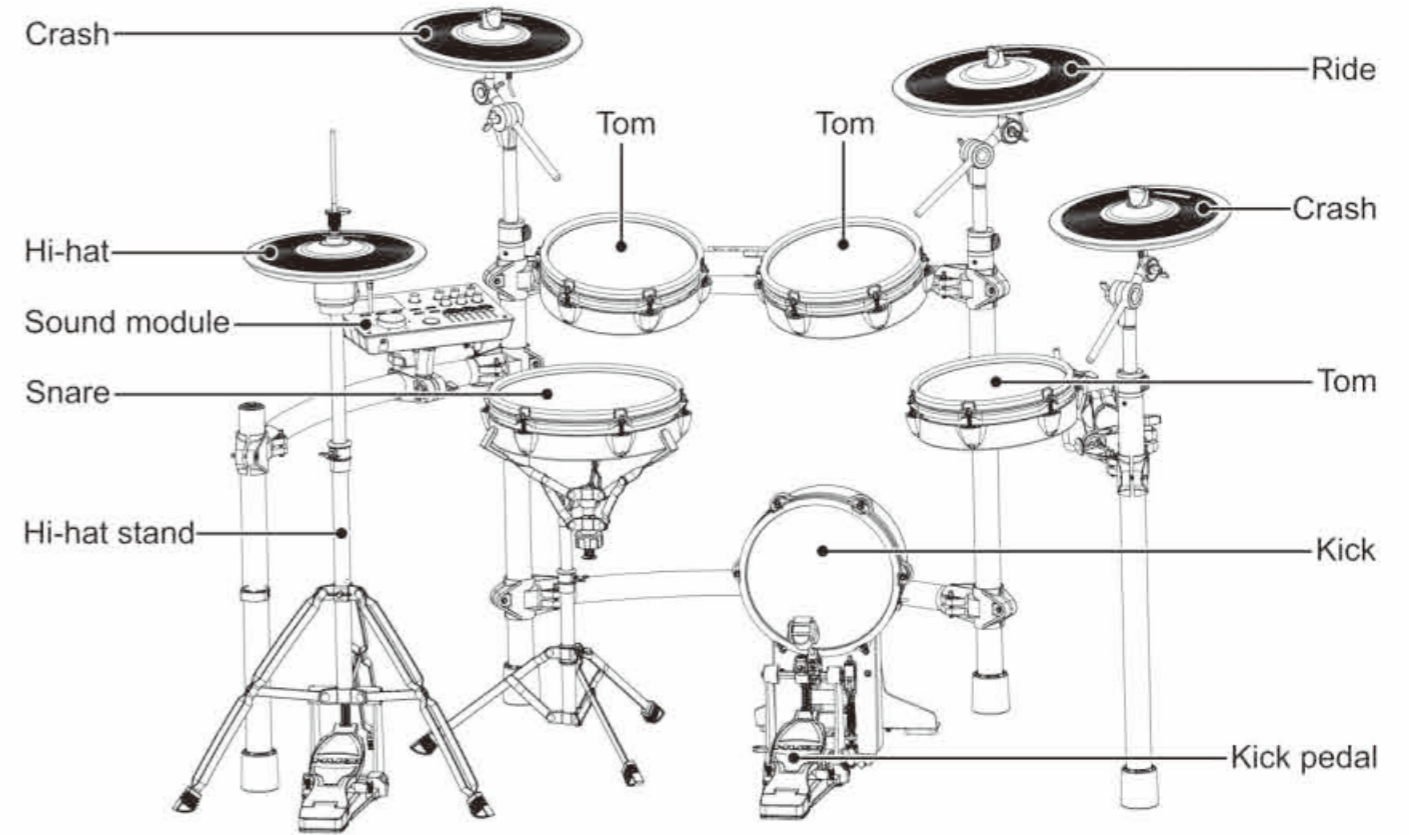

Catalog

Control Panel	
Front panel	02
Top panel	03
Connecting audio equipment	04
About the screen	05
Ready to play	
Turn on/off the power	06
How you can play on DM-8	07
Drum kit operation	
Drum kit switch	09
Drum kit sound settings	09
Drum pad tone settings	09
Group fader	09
Song function operation	10
Recording operation	10
Coach function	12
System menu operation	
Hi-hat set	15
Click	15
Effect	15
Song	16
Trigger	16
Panning	17
Kit name	17
Wav files	17
Output	19
Midi note	19
Factory reset	19
Option	20
USB audio\USB midi	20
MIDI list	21
Technical specifications	22

Control Panel

Front panel



- | | |
|---|---|
| <p>1 Display
Display DM-8 operation information</p> <p>2 Display operation button
Display parameter button, operate according to the display content</p> <p>3 Drum set switching encoder
It is used for overall switching of drum timbre</p> <p>4 TEMPO
Metronome speed quick adjustment knob</p> <p>5 SONG LIST
Song selection knob</p> <p>6 SONG VOL
Song volume knob</p> <p>7 CLICK
Metronome on/off button</p> <p>8 USB SONG
Enter/exit the music selection interface in the U disk, this button is only valid after the U disk is inserted</p> | <p>9 DRUM OFF
Turn on/mute the drum sound in the built-in DEMO song</p> <p>10 ENTER, KICK/SNARE
Confirm button, quick access to KICK/SNARE selection button</p> <p>11 INSTRUMENT
Parameter adjustment knob</p> <p>12 TOM/CYMBAL
Quickly enter the TOM/CYMBAL selection button</p> <p>13 AUX
External audio device volume adjustment knob</p> <p>14 PHONE
Headphone volume adjustment knob</p> <p>15 MASTER
Output volume adjustment knob</p> <p>16 3.5mm Output
Headphone interface</p> |
|---|---|

Control Panel

- 17 REC**
Record button, need to be used with U disk
- 18 PREVIEW**
Sound preview button
- 19 PLAY/STOP**
Music play/pause button
- 20 GROUP FADER**
Quick volume adjustment fader for each instrument

Top panel

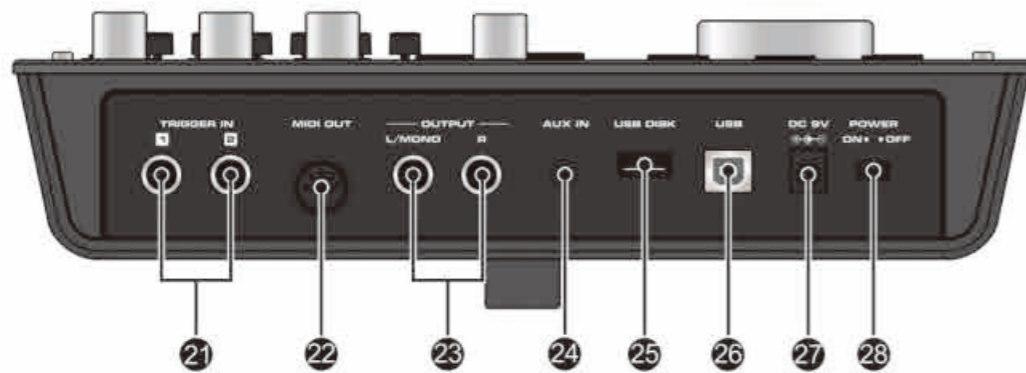

- 21 TRIGGER IN 1, 2**
Expansion interface
- 22 MIDI OUT**
MIDI OUT interface
- 23 OUTPUT L/MONO, R**
Used to connect DM-8 to an external audio amplifier. When using mono output, please use L/MONO
- 24 AUX IN**
Connect external audio equipment, such as mp3, mobile phone, CD player, etc.
- 25 USB DISK**
USB DISK interface
- 26 USB**
Used to connect the DM-8 module to the computer
- 27 DC-9V**
9V power adapter interface
- 28 POWER**
Power switch

Connecting audio equipment

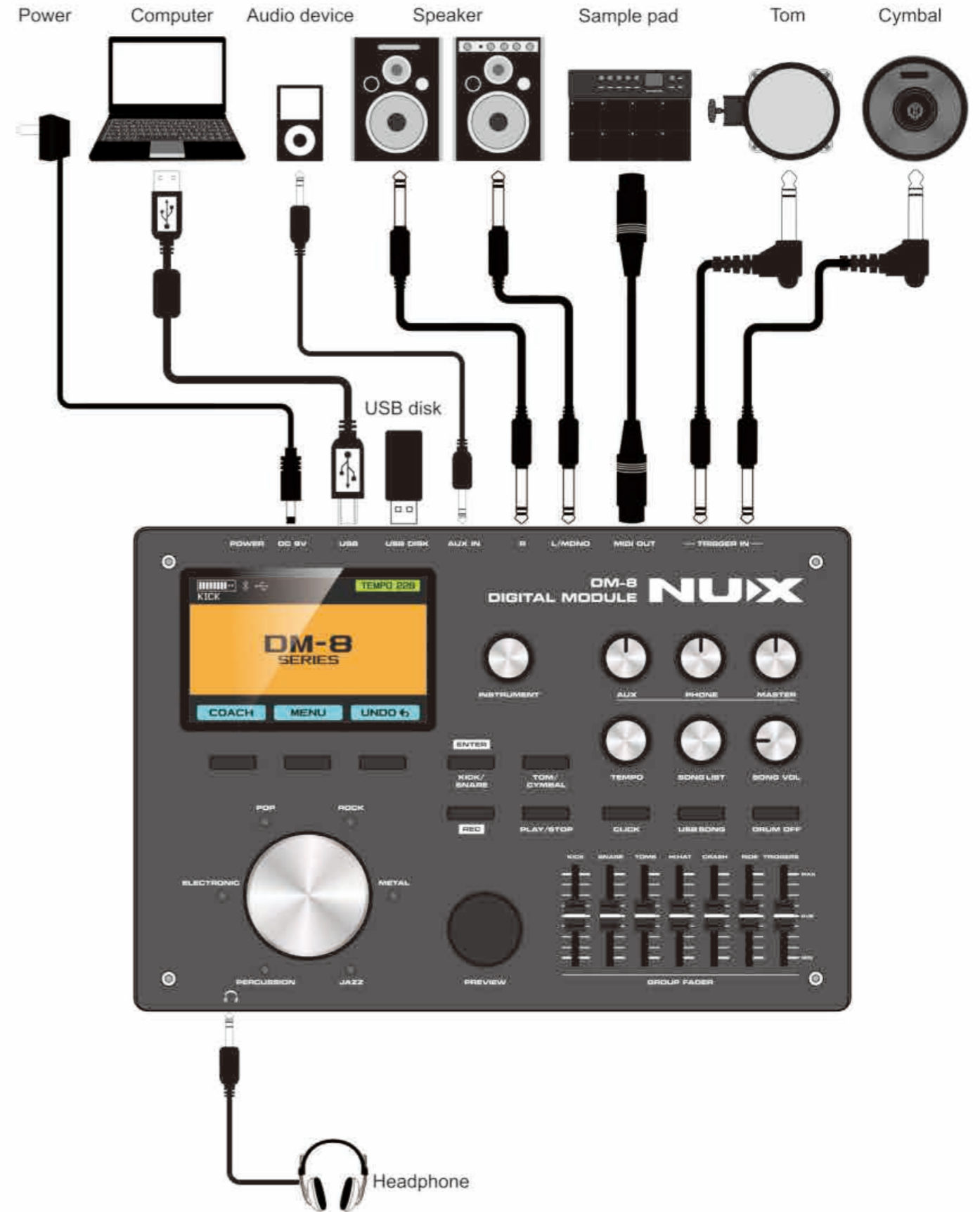

WARNING

To prevent equipment damage, please turn down the volume before turn on DM-8 or connect it to other driver.

About the screen

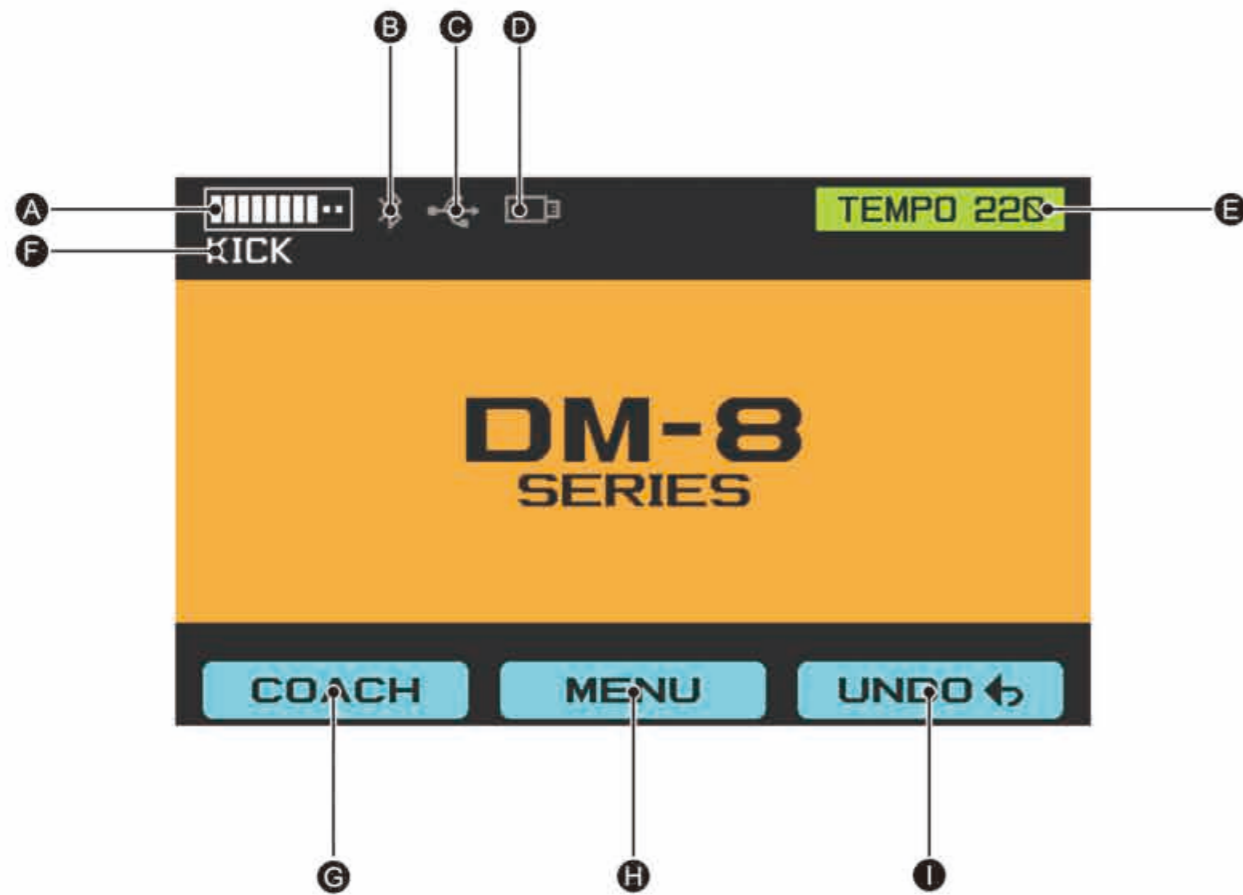

- A Ten-level force display
- B Blue-tooth icon
- C USB connect icon
- D USB disk icon
- E Metronome speed display

- F The pad you playing
- G Coach function
- H Menu function
- I UNDO

Ready to play

Turn on/off the power

*Turn on the power

1. Turn down the master volume.
2. Turn down the speaker's volume.
3. Turn on the power.



Power on display

*When you turning on the power, you may hear a faint sound, this in normal.

*Turn off the power

1. Turn down the speaker's volume.
2. Turn off the module.



Ready to play

How you can play on DM-8

*Snare

Head shot

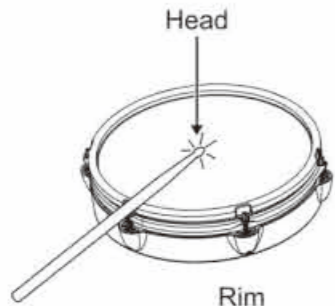

Cross stick



Rim shot

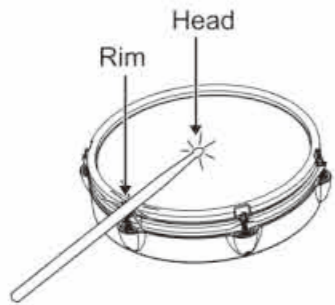

*Tom

Head shot

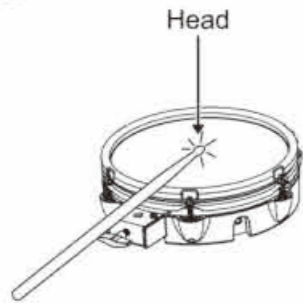

Rim click

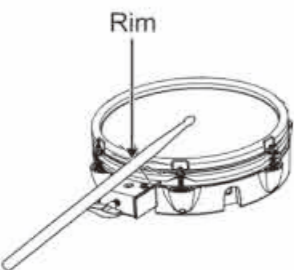

*Kick

Hit the drum head

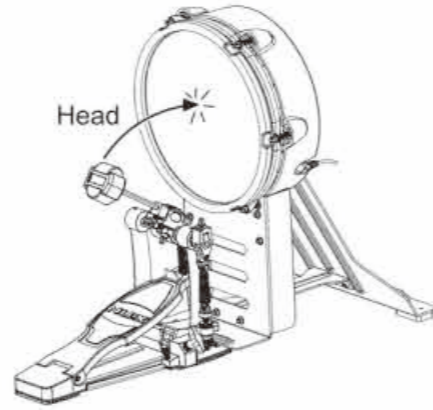

*Crash

Bow shot

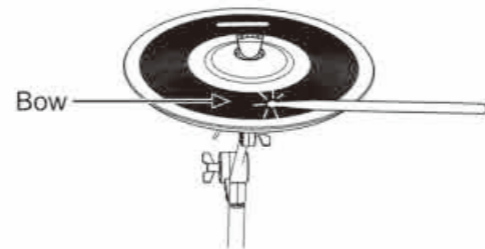

Edge shot

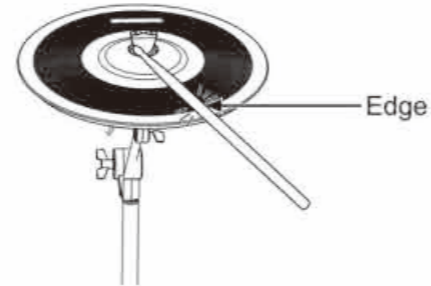

*Ride

Bow shot

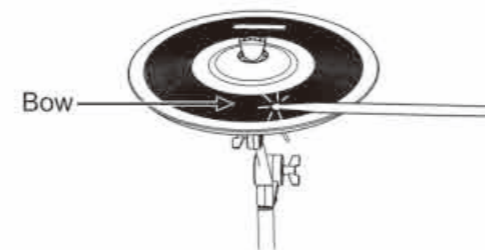

Ready to play

Edge shot

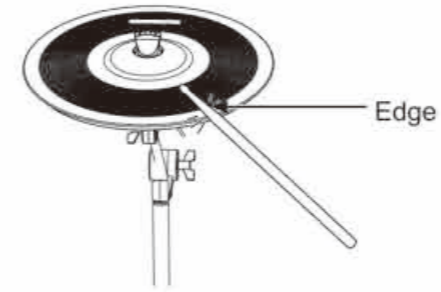

Bell shot

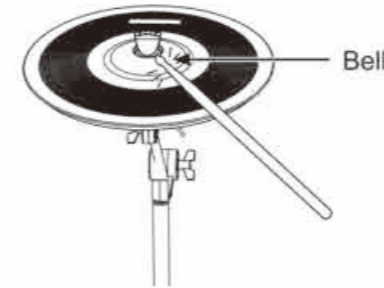

Choking a cymbal

Choking the cymbal's edge with a hand immediately after hitting the cymbal will mute or choke the sound. Just like with a real cymbal, the choke function only works when you grasp in the area.

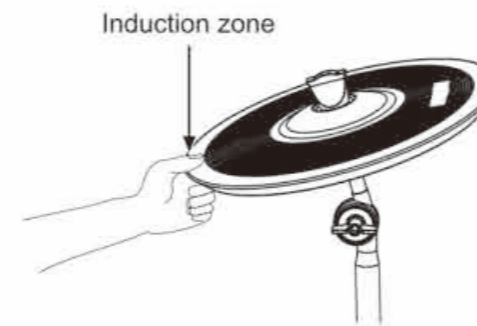

*Hi-hat

Open\Close

The cymbal tone will change between open and closed, depending on the force control of the cymbal pedal and cymbal blade.

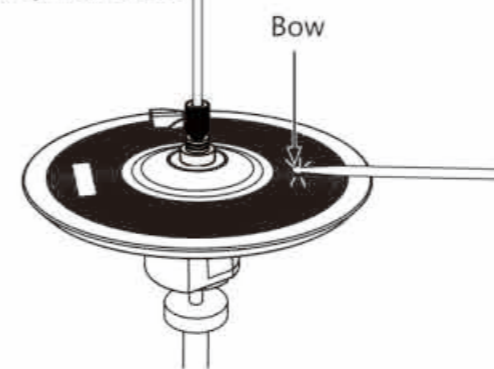

Edge shot

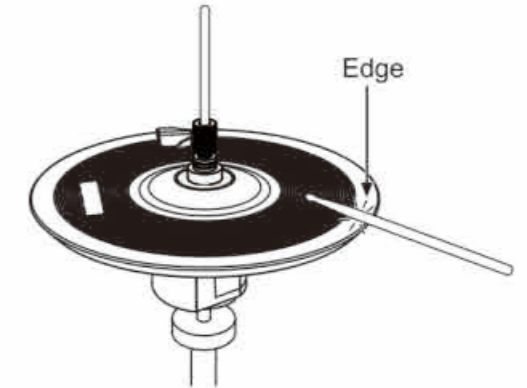

Choking a cymbal

Choking the cymbal's edge with a hand immediately after hitting the cymbal will mute or choke the sound. Just like with a real cymbal, the choke function only works when you grasp in the area.

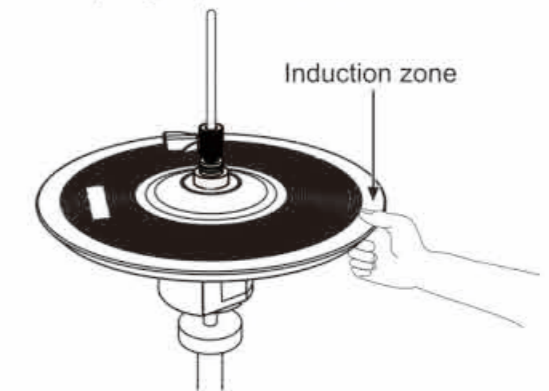

*Hi-hat control pedal

Open Hi-hat

Strike the Hi-hat without pressing the pedal.

Closed Hi-hat

Strike the Hi-hat with the pedal pressed.



Drum kit operation

Drum kit switch

*Power on and enter the drum kit mode

1. Use the selector to select the drum kit style, press the selector to confirm the style to indicator light flashing, and turn the selector again to select the kit.



2. Turn the selector to enter the drum kit mode in any mode.

Drum kit sound settings

1. Use the drum kit selector to select the drum kit you want to edit.
2. Use any buttons as below pic to enter the edit mode.



3. Hit the pad to select the pad (or you can just press KICK/SNARE, TOM/CYMBAL) to select.



Drum pad tone settings

1. In the sound modify mode, select the pad you want to edit.



2. Use the buttons at the bottom of the display to select the parameters you want to adjust.
3. Use the INSTRUMENT knob to adjust the parameters.
4. You can preview the tone via hit the PREVIEW button on the module (with power sensing).



Parameter comparison table

Parameter	Range	Description
INSTRU		Pad tone selection
PITCH	-32~+32	Tone pitch adjustment
LEVEL	0~127	Pad volume adjustment
SPLIT		After clicking the SPLIT button, the rim/head sound of the pad can be assigned separately Snare: head, rim Tom: head, rim Hi-hat: Bow, edge Crash: Bow, edge Ride: Bow, edge, bell

Group fader

DM-8 adds the function of real-time adjustment of output level. You can adjust the output for each instrument in real-time through the faders on the panel of the module, so as to achieve the most suitable volume balance for you.



Song function operation

* Without USB flash drive

1. Under the main interface, turn the SONG LIST knob on the panel to enter the SONG interface.

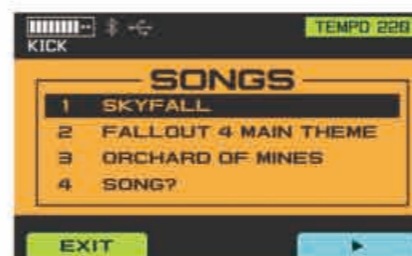

2. Under the SONG interface, press the play button at the bottom of the screen or PLAY/STOP on the panel to play or pause the music.



3. Press the DRUM OFF button on the panel to mute or activate the drum sound in the song (this function is only valid for the built-in song).



* With USB flash drive

1. After the USB flash drive is inserted into the module, the USB flash drive icon on the display is lit.



Drum kit operation

2. Turn the SONG LIST knob on the module panel to enter the SONG interface, and then press the USB SONG button on the panel to enter the USB SONGS interface.



3. In the USB SONGS interface, press the play button at the bottom of the screen or the PLAY/STOP button on the panel to play or pause the music in the USB flash drive.

Note: Only .wav and .midi formats are supported. Before that, please create a folder named 'SONG' in the U disk and put the music you want to play in this folder. The name of the music only supports English characters.

Recording operation

*This function must be used with a USB flash drive. If you press REC without inserting a USB flash drive, the system will prompt the following interface.

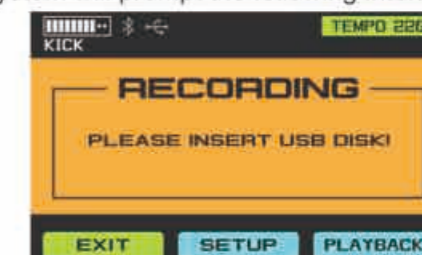

1. After inserting the USB flash drive, press the REC button on the panel to enter the recording mode.

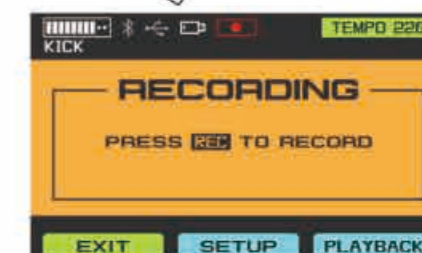

Drum kit operation

2. Press REC again in recording mode to start recording.



3. Press the stop button to end the recording. After the recording is over, you can press the play button to play the track just now. Press the SAVE button in the middle to save the track to the USB flash drive (the recording is in .wav format).



*If the following prompt pops up during the saving process, please clear the storage space of the USB flash drive and try again.



4. In the main interface of recording mode, press SETUP to enter the recording setting interface, select the option you want to adjust and press ENTER to enter.



● VOLUME SETUP

You can adjust the volume balance of the background music and the drum sound in the recording.



● BACKING TRACK

You can select the desired song in the recording. During the selection process, you can use the USB SONG button on the panel to switch between the music in the U disk or the music in the sound module.



● SONG SETUP

Used to adjust the various parameters of song playback. (This parameter adjustment will affect the recording content).



Parameter	Range	Description
DRUM OFF	ON/OFF	Mute or activate the drum sound in the song
CYCLE PLAY	ON/OFF	Turn on/off the playback of the song
BACK VOLUME	0~127	Song volume adjustment
DRUM VOLUME	0~127	Drum volume adjustment

Drum kit operation

Coach function

1. On the DRUM KIT table, click on COACH to enter the coaching function.



2. Use the up and down keys to select the function you want to practice and press ENTER to enter.



* ACCENTS SHIFT

In this mode, you can practice the accent transfer.

1. Enter this mode, after the automatic four-shot preparation, the practice begins.



2. After finishing the exercise, automatically enter the score interface to score this exercise. (Press START to start the exercise again)



3. Click SETUP to enter the setting interface, press the up and down keys to select the item you want to set, and adjust the parameters by using the INSTRUMENT knob.



Parameter	Range	Description
RHYTHM SHIFT	8 th \Triplet\16 th	Accent type switching
SOUND	FULL4 th \ACCENT\QUEIT	Sound switching
SCORE	OFF\4bar\8bar\16bar\32bar	Scoring mode switching

4. Click CLICK to enter the metronome setting interface, press the up and down keys to select the parameter you want to adjust, and adjust it by using the INSTRUMENT knob.



Parameter	Range	Description
TEMP	40~280	Speed adjustment
SOUND		Metronome tone type
VOLUME	0~127	VOL switching

* TIME CHECK

In this mode, you can train your hit accuracy.

1. Enter this mode, after the automatic four-shot preparation, the practice begins.



Drum kit operation

2. After finishing the exercise, automatically enter the score interface to score this exercise. (Press START to start the exercise again)



3. Click SETUP to enter the setting interface, press the up and down keys to select the item you want to set, and adjust the parameters by using the INSTRUMENT knob.



Parameter	Range	Description
SCORE	OFF\4bar\8bar\16bar\32bar	Scoring mode switching
DISPLAY 1	KICK\SNARE\TOMS\RIDE\CYMS\HIHAT	Test position 1
DISPLAY 2	KICK\SNARE\TOMS\RIDE\CYMS\HIHAT	Test position 1
GAUGE	LEFT AHEND\LEFT BEHIND	Measurement mode switching

4. Press the CLICK button to enter the metronome setting interface, press the up and down keys to select the parameter you want to adjust, and adjust it by using the INSTRUMENT knob.

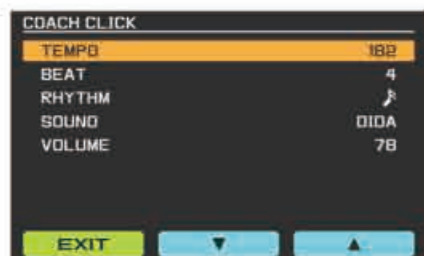

Parameter	Range	Description
TEMP	40~280	Speed adjustment
BEAT	1~9	Beat adjustment
RHYTHM	Triplet\4 th \8 th \16 th	Note switching
SOUND		Metronome tone type
VOLUME	0~127	VOL switching

* QUIET COUNT

In this mode, you can train the sense of time, and the metronome will alternate between "sound and mute".

1. Enter this mode, start the practice after the automatic four-shot preparation.

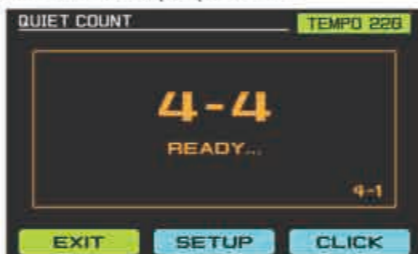

2. The metronome is muted when practicing to silent shooting.



3. Automatically score after each session is completed and continue to practice.



4. Click the SETUP button to enter the setting interface, press the up and down keys to select the item you want to set, and adjust the parameters by using the INSTRUMENT knob.

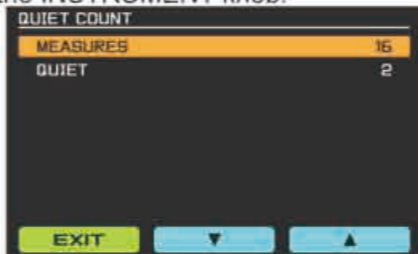

Parameter	Range	Description
MEASURES	4\8\12\16	Number of beats per measure
QUIET	1\2\4\8	Silent beat

5. Click the CLICK button to enter the metronome setting interface, press the up and down keys to select the parameter you want to adjust, and use the INSTRUMENT knob to adjust.

Drum kit operation

3. Click the CLICK button to enter the metronome setting interface, press the up and down keys to select the parameter you want to adjust, and adjust it by using the INSTRUMENT knob.



Parameter	Range	Description
TEMP	40~280	Speed adjustment
BEAT	1~9	Beat adjustment
SOUND		Metronome tone type
VOLUME	0~127	VOL switching



Parameter	Range	Description
TEMP	40~280	Speed adjustment
BEAT	1~9	Beat adjustment
RHYTHM	Triplet\4 th \8 th \16 th	Note switching
SOUND		Metronome tone type
VOLUME	0~127	VOL switching

* CHANGE UP

In this mode, you can train your performance speed accuracy for different notes at the same time value.

1. Enter this mode, start the practice after the automatic four-shot preparation.



2. This mode does not set a score, click SETUP to enter the setting interface, use the up and down keys to select the item you want to set, and adjust the parameters with the INSTRUMENT knob.



Parameter	Range	Description
DURATION	5\10\15\20 MINS	Practice time
CHANGE-UP	16th\5\6	Note adjustment
MEASURES	1\2\4\8	Beat adjustment

System menu operation

Click the MENU button at the bottom of the screen to enter the menu, use the left and right buttons or the INSTRUMENT knob to select the item you want to adjust, and press the ENTER button to enter.



System main interface



System setting interface

HI-HAT SET

Select HIHAT SET and press ENTER to enter. This interface is used to adjust the parameters of the hi-hat system.

The DM-8 hi-hat has three states, closed, half-open, and full-open.

HH VOLUME is to adjust the hi-hat volume value, the parameter range is 0~127.

The interval between OP and CL is the half-open cymbal range, which can be adjusted by adjusting HH OPEN VAL and HH CLOSE VAL. Over OP is a fully open, under CL is closed.

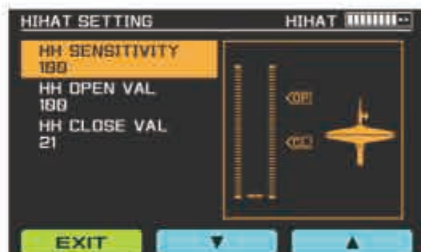

CLICK

1. Select CLICK in the MENU interface, press ENTER to enter.
2. Use the up and down keys to select the parameter you want to adjust, and use the INSTRUMENT knob to adjust the parameter value.



Parameter comparison table

Parameter	Range	Description
TEMP	40~280	Speed adjustment
BEAT	1~9	Beat adjustment
RHYTHM	Triplet 4 th 8 th 16 th	Note switching
SOUND		Metronome tone type
VOLUME	0~127	VOL switching

EFFECT

1. Select EFFECT in the MENU interface, press ENTER to enter.
2. Use the left and right keys or the INSTRUMENT knob to select the effect you want to set, and press ENTER to set the effect interface.
3. After entering the effect setting interface, press ENTER to turn on or off the effect. Use the left and right keys to select the parameter you want to adjust, and then use the INSTRUMENT knob to select the parameter value.



PAD EQ

It can be used to adjust the EQ of each pad.



System menu operation

SONG

1. Select SONG in the MENU interface, press ENTER to enter.
2. Use the up and down keys to select the parameter you want to adjust, turn the INSTRUMENT knob to adjust the parameter value.



Parameter comparison table

Parameter	Range	Description
DRUM OFF	ON/OFF	Mute or activate the drum sound in the song
CYCLE PLAY	ON/OFF	Turn on/off the playback of the song
BACK VOLUME	0~127	Song volume adjustment
DRUM VOLUME	0~127	Drum volume adjustment

TRIGGER

1. In the MENU interface, select TRIGGER, press ENTER to enter.
2. Hit the pad, select the pad you want to adjust.
3. Use the up and down keys to select the parameter you want to adjust, turn the INSTRUMENT knob to adjust the parameter value.

* When the sensitivity is high, the sound will be loud even you hit the pad slightly. And when the sensitivity is low, the sound will be soft no matter how hard you hit. So please adjust the sensitivity according to your preference.



Parameter comparison table

Parameter	Range	Description
SENSITIVITY	1~99	Head or bow sensitivity adjustment. When the sensitivity is high, the sound will be loud even you hit the pad slightly. And when the sensitivity is low, the sound will be soft no matter how hard you hit. So please adjust the sensitivity according to your preference.

PAD COMP

PAD COMPRESSOR. It can be used to adjust the compressor of each pad.



MASTER EQ

It can be used to adjust the master EQ of the drum set.



MASTER COMP

MASTER COMPRESSOR. It can be used to adjust the master compressor of the drum set.



OVERDRIVE

It can be used to add the overdrive effect to the drum set.





REVERB

It can be used to add the reverb to the drum set.

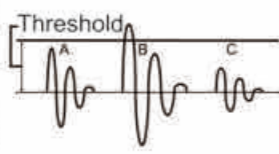
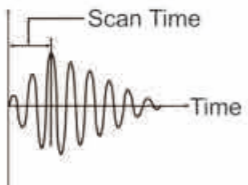
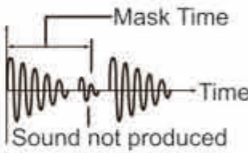

System menu operation

Parameter comparison table		
Parameter	Range	Description
THRESHOLD	1~99	Adjust the trigger level of the drum.
<p>As shown on the right, the B waveform will sound and the A and C waveforms will not occur.</p> <p>Note: If the value you set is too high, a light blow will not sound.</p> 		
SCAN TIME	1MS~8MS	Adjust the detection time of the trigger signal.
<p>When setting, try a soft and powerful blow and confirm the natural changer in volume.</p> <p>Note: If the value you set is too high, the sounding time will be lengthened. Please set as low as possible.</p> 		
MASK TIME	4MS~64MS	Adjust the masking time of the trigger signal.
<p>Note: When playing fast, too high values may mask the trigger signal, so lower the value as much as possible.</p> 		
RETRIG CANCEL	0~99	Adjust the repeat trigger value of the trigger signal.
		
XTALK CANCEL	0%~80%	Adjust the crosstalk value.
<p>When hit, some drums that are not hit are also triggered to sound, improving the XTALK CANCEL of the drum that is being audible.</p> <p>Note: If the value is set too high and the strike is at the same time, the drum with a small striking force may not be triggered. Therefore, the value is set as small as possible without crosstalk.</p>		
CURVE	LINEAR/EXP/LOG/LOUD	
RIM GAIN	1~99	Adjust the edge gain to be effective only for the drum rim and cymbal edge.

Parameter comparison table		
Parameter	Range	Description
RIM SHOT SENSITIVITY	1~99	RIM SHOT sensitivity adjustment
HEAD RIM ADJUST	1~99	This parameter is about the relationship between the head and rim(bow and edge)

Note: The parameter will be saved automatically when exiting this mode.

PANNING

1. In the MENU interface, select PANNING to enter.
2. Use the up and down keys to select PAD PANNING, or hit the drum pad to select the pad you want to adjust. Use the INSTRUMENT knob to adjust the parameters.

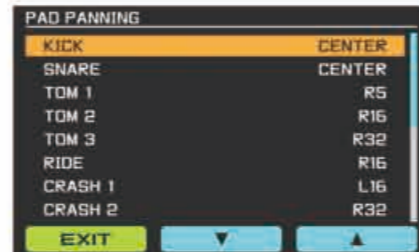

KIT NAME

1. In DRUM KIT mode, select the drum kit you want to rename.
2. Click MENU to enter the menu, select KIT NAME to enter the drum kit naming.
3. Use the left and right keys to select the position, and use the INSTRUMENT knob to adjust the character.



WAV FILES

*This function must be used with an external U disk, this function is used to import or delete WAV files.

Note: First of all, you need to create a folder named 'WAVIMPORT' in the U disk and then name the WAV file you want to import with English characters. After that, import the WAV

System menu operation

file into the 'WAVIMPORT' folder. Please noted :
 1. The maximum of the WAV files you can import is 100. 2. The total size of the files imported shall not exceed 100M. 3. The duration of each WAV file shall not exceed 20 seconds.

1. After inserting the U disk, in the MENU interface, select WAV FILES to enter WAV settings.
2. Use the INSTRUMENT knob or left right keys to select the item you want to set, press ENTER to enter.



● IMPORT A WAV

This function is to import a single WAV file from the U disk to the module.



After importing, you can find the imported tone in the drum pad tone setting function, and assign the imported tone to the pad you need.



● IMPORT ALL WAV

This function can import all the wav files in the 'WAVIMPORT' folder from the U disk to the module at one time.



After importing, you can find the imported tone in the drum pad tone setting function, and assign the imported tone to the pad you need.



● DELETE A WAV

You can choose to delete a single previously imported WAV file in the module. Use the up and down keys or the INSTRUMENT knob to select, press the ENTER key to confirm.



● DELETE ALL WAV

This function is used to delete all WAV files previously imported into the module at one time.



System menu operation

OUTPUT

This function provides three different output distribution modes for users .

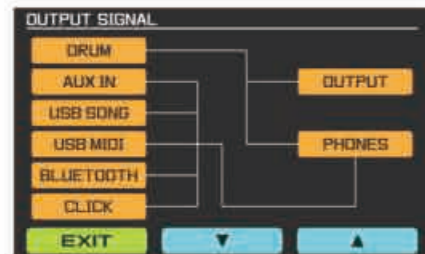
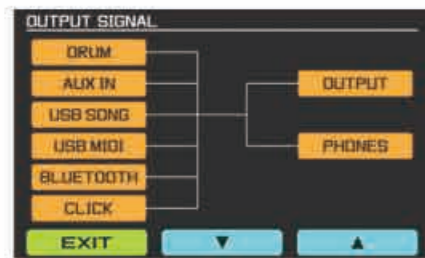
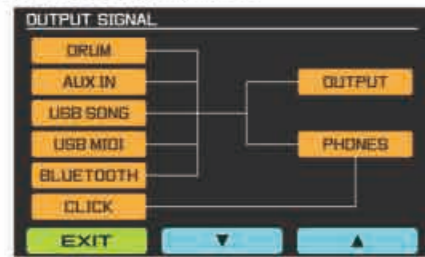

MIDI NOTE

*Set the MIDI code corresponding to the output of the pad, OFF means no MIDI signal is output.

- 1.In the MENU interface, select MIDI NOTE, press ENTER to enter the setting.
- 2.Use the up and down keys to select the pad you want to set, and use the INSTRUMENT knob to adjust the parameter value.

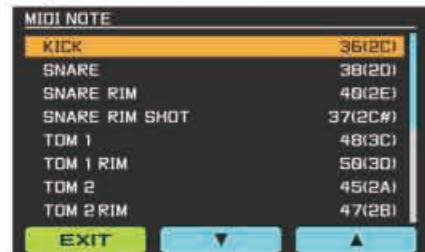

Parameter comparison table

Parameter	Range	Description
KICK	OFF, 0~127	Kick MIDI code
SNARE	OFF, 0~127	Snare MIDI code
SNARE RIM	OFF, 0~127	Snare rim MIDI code
SNARE RIM SHOT	OFF, 0~127	Snare rim shot MIDI code
TOM 1	OFF, 0~127	Tom1 MIDI code

TOM 1 RIM	OFF, 0~127	Tom1 rim MIDI code
TOM 2	OFF, 0~127	Tom2 MIDI code
TOM 2 RIM	OFF, 0~127	Tom2 rim MIDI code
TOM 3	OFF, 0~127	Tom3 MIDI code
TOM 3 RIM	OFF, 0~127	Tom3 rim MIDI code
RIDE BOW	OFF, 0~127	Ride bow MIDI code
RIDE EDGE	OFF, 0~127	Ride edge MIDI code
RIDE BELL	OFF, 0~127	Ride bell MIDI code
CRASH 1 BOW	OFF, 0~127	Crash 1 bow MIDI code
CRASH 1 EDGE	OFF, 0~127	Crash 1 edge MIDI code
CRASH 2 BOW	OFF, 0~127	Crash 2 bow MIDI code
CRASH 2 EDGE	OFF, 0~127	Crash 2 edge MIDI code
HH OPEN BOW	OFF, 0~127	HH open bow MIDI code
HH OPEN EDGE	OFF, 0~127	HH open edge MIDI code
HH HALF OPEN BOW	OFF, 0~127	HH half open bow MIDI code
HH HALF OPEN EDGE	OFF, 0~127	HH half open edge MIDI code
HH CLOSE BOW	OFF, 0~127	HH close bow MIDI code
HH CLOSE EDGE	OFF, 0~127	HH close edge MIDI code
HH PEDAL	OFF, 0~127	HH pedal MIDI code
TRIG 1	OFF, 0~127	Trigger 1 MIDI code
TRIG 1 RIM	OFF, 0~127	Trigger 1 rim MIDI code
TRIG 2	OFF, 0~127	Trigger 2 MIDI code
TRIG 2 RIM	OFF, 0~127	Trigger 2 rim MIDI code

FACTORY RESET

- 1.In the MENU screen, select FACTORY RESET and press ENTER to enter.
- 2.Use the up and down keys to select the parameter you want to adjust and press ENTER to enter the setting.



Parameter	Description
RESET CURRENT KT	Restore all current parameters of this drum kit to the factory settings.
RESET ALL KT	Restore all parameters of all drum kits to factory settings.
RESET SYSTEM	Restore the source system version content to factory settings.
RESET ALL	Restore all content values to factory settings. (one click recovery)

System menu operation

OPTION

- 1.In the MENU interface, select OPTION and press ENTER to enter.
- 2.Use the up and down keys to select the parameter you want to adjust, and use the INSTRUMENT knob to adjust the parameter value.



3. When you adjust the MEMORY LOCK parameter, such as selecting LOCK, a lock icon will appear on the main screen. At this time, it means that no matter you modify any parameters, it will not be automatically saved.



Parameter comparison table

Parameter	Range	Description
BRIGHTNESS	1~10	Screen brightness adjustment
MIDI OUT CHANNEL	1~16	MIDI out channel selection
MEMORY LOCK	LOCK/UNLOCK	Memory lock selection
BLUETOOTH	BOTH ON/AUDIO ON/MIDI ON	Bluetooth on/off
SYSTEM INFO RMATION		System version

BLUETOOTH CONNECTION

Turn on the Bluetooth function of the mobile phone, find the DM-8 series in the device list, and click Connect. After successfully connected, the audio in the mobile phone can be played through DM-8.

USB AUDIO\USB MIDI

- 1.Use a USB cable to connect the DM-8 to the computer. After the connection is successful, the USB icon on the screen will light up.

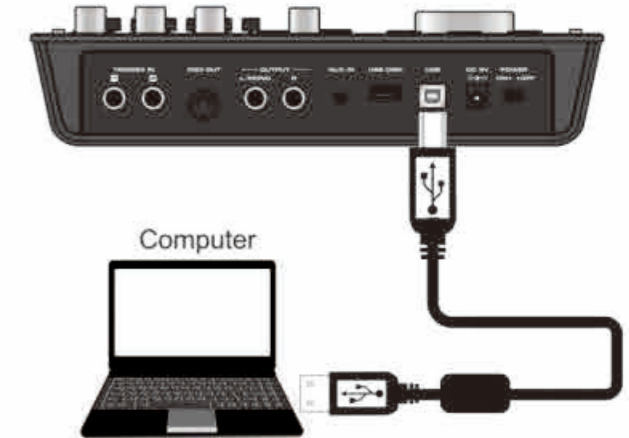

- 2.The DM-8 module is an audio/MIDI recording interface in itself, with the ability to send stereo sound and MIDI data to a Mac or Windows computer via a single USB cable. This lets you record discrete audio and MIDI drum tracks in any DAW, or trigger sounds in software-based drum instruments for studio or live playing.

Note: You need to select 'NUX DM-8 as the input device on the DAW's input device to record multi-track audio.

Function	Transmitted	Recognized	Remarked	
Basic default	10	1~16		
Channel changed	No	No		
Note	0~127	0~127		
Velocity:	Note on	Yes	Yes	
	Note off	No	Yes	
After key's	No	Yes		
Touch Channel's	No	Yes		
Control change:	0	No	No	Bank select
	1	No	Yes	Modulation
	5	No	Yes	Portamento time
	7	No	Yes	Volume
	10	No	Yes	Pan
	11	No	Yes	Expression
	64	No	Yes	Sustain pedal
	65	No	Yes	Portamento on/off
	66	No	Yes	Sostenuto pedal
	67	No	Yes	Soft pedal
	120	No	Yes	All sound off
121	No	Yes	Reset all controllers	
123	No	Yes	All note off	
Program change	No	Yes	Yes	
System exclusive	No	No	No	

Display:	TFT LCD color screen
Tones:	30 sets of self-sampling tones, the number of single tones is about 300
Drum set:	48 sets of drum sets (30 sets of presets, 18 sets of user-defined sets)
USB:	USB AUDIO, USB MIDI, USB flash drive
Effect:	PAD EQ, PAD COMPRESSOR, MASTER EQ, MASTER COMPRESSOR, OVER DRIVE, REVERB
Coach function:	Accents, Time check, Quiet count, Change up
Import audio files:	Import audio files: Import limited to 100 wav files or 100M, and the sampling format is WAV
Trigger:	TOM*3(Dual-zone), SNARE*1(Three-zone, head, rim, rim shot), HIHAT*1(Dual-zone), CRASH*2(Dual-zone), RIDE*1(Three-zone, bow, edge, bell), KICK*1(Single-zone)
Interface:	Power interface, USB interface, USB DISK interface, AUX IN interface, OUTPUT interface, MIDI OUT interface, TRIGGER IN interface, headphone interface
Power:	DC 9V

*Technical specifications are subject to change without notice.

FCC ID: 2A0AA-DM-8

FCC WARNING:

This device complies with part 15 of the FCC Rules. Operation is subject to the following two conditions: (1) this device may not cause harmful interference, and (2) this device must accept any interference received, including interference that may cause undesired operation. Any changes or modifications not expressly approved by the party responsible for compliance could void the user's authority to operate the equipment.

NOTE: This equipment has been tested and found to comply with the limits for a Class B digital device, pursuant to Part 15 of the FCC Rules. These limits are designed to provide reasonable protection against harmful interference in a residential installation. This equipment generates, uses and can radiate radio frequency energy and, if not installed and used in accordance with the instructions, may cause harmful interference to radio communications. However, there is no guarantee that interference will not occur in a particular installation.

If this equipment does cause harmful interference to radio or television reception, which can be determined by turning the equipment off and on, the user is encouraged to try to correct the interference by one or more of the following measures:

- Reorient or relocate the receiving antenna.
- Increase the separation between the equipment and receiver.
- Connect the equipment into an outlet on a circuit different from that to which the receiver is connected.
- Consult the dealer or an experienced radio/TV technician for help.

To maintain compliance with FCC's RF Exposure guidelines, This equipment should be installed and operated with minimum distance between 20cm the radiator your body: Use only the supplied antenna.

According to the technical specifications of low-power radio frequency equipment:

For low-power radio frequency equipment that has been certified, companies, firms, or users are not allowed to change the frequency, increase the power, or change the characteristics and functions of the original design without approval. The use of low-power radio frequency equipment must not affect flight safety and interfere with legal communications; if interference is found, it should be stopped immediately and improved to no interference before continuing to use. The aforementioned legal communication refers to radio communication operated in accordance with the provisions of the Telecommunications Administration Law. Low-power radio frequency equipment must endure the interference of legal communications or industrial, scientific and medical radio wave radiation electrical equipment.



Made in China