



# Test Report

FCC ID: 2AOAA-B-2

Date of issue: Nov. 15, 2017

Report Number:	CF17112305
Sample Description:	B-2 2.4GHz Wireless System
Model(s):	B-2
Applicant:	Cherub Technology Co., Ltd
Address:	Room507, Block 1, Nanhai E-Cool, No. 6 Xinghua Road, Shekou, Nanshan District, Shenzhen City, Guangdong Province, China, 518067
Date of Test:	Nov. 03, 2017 to Nov. 15, 2017



<b>TEST RESULT CERTIFICATION</b>	
<b>Applicant's name</b> .....	<b>Cherub Technology Co., Ltd</b>
Address .....	Room507, Block 1, Nanhai E-Cool, No. 6 Xinghua Road, Shekou, Nanshan District, Shenzhen City, Guangdong Province, China, 518067
<b>Manufacture's Name</b> .....	<b>Cherub Technology Co., Ltd ( Zhuhai High-tech Park )</b>
Address .....	No.10, Keji No. 9 Rd, Tangjiawan Town, Zhuhai National Hi-tech industrial Development Zone, Zhuhai City, Guangdong Province, China, 519080
<b>Product description</b>	
Product name .....	B-2 2.4GHz Wireless System
Model and/or type reference :	B-2
Serial Model.....	N/A
<b>Standards</b> .....	FCC Part15.247
Test procedure.....	ANSI C63.10:2013

*This device described above has been tested by WH Technology Corp. and the test results show that the equipment under test (EUT) is in compliance with the FCC requirements. And it is applicable only to the tested sample identified in the report.*

Tested by:

Bell Wei

Nov. 28, 2017

Approved by:

Mike Lee

Nov. 28, 2017



**Table of Contents**

	<b>Page</b>
<b>1 . SUMMARY OF TEST RESULTS</b>	<b>5</b>
1.1 TEST FACILITY	6
1.2 MEASUREMENT UNCERTAINTY	6
<b>2 . GENERAL INFORMATION</b>	<b>7</b>
2.1 GENERAL DESCRIPTION OF EUT	7
2.2 DESCRIPTION OF TEST MODES	8
2.3 BLOCK DIGRAM SHOWING THE CONFIGURATION OF SYSTEM TESTED	9
2.4 DESCRIPTION OF SUPPORT UNITS(CONDUCTED MODE)	10
2.5 EQUIPMENTS LIST FOR ALL TEST ITEMS	11
<b>3 . EMC EMISSION TEST</b>	<b>12</b>
3.1 CONDUCTED EMISSION MEASUREMENT	12
3.1.1 POWER LINE CONDUCTED EMISSION LIMITS	12
3.1.2 TEST PROCEDURE	14
3.1.3 DEVIATION FROM TEST STANDARD	14
3.1.4 TEST SETUP	14
3.1.5 EUT OPERATING CONDITIONS	14
3.1.6 TEST RESULTS	15
3.2 RADIATED EMISSION MEASUREMENT	17
3.2.1 RADIATED EMISSION LIMITS	17
3.2.2 TEST PROCEDURE	17
3.2.3 DEVIATION FROM TEST STANDARD	18
3.2.4 TEST SETUP	19
3.2.5 EUT OPERATING CONDITIONS	20
3.2.6 TEST RESULTS (BETWEEN 9KHZ – 30 MHZ)	21
3.2.7 TEST RESULTS (BETWEEN 30MHZ – 1GHZ)	22
3.2.8 TEST RESULTS (1G-25GHZ)	23
<b>4 . POWER SPECTRAL DENSITY TEST</b>	<b>25</b>
4.1 APPLIED PROCEDURES / LIMIT	25
4.1.1 TEST PROCEDURE	25
4.1.2 DEVIATION FROM STANDARD	25
4.1.3 TEST SETUP	25
4.1.4 EUT OPERATION CONDITIONS	25



**Table of Contents**

	<b>Page</b>
4.1.5 TEST RESULTS	26
<b>5 . BANDWIDTH TEST</b>	<b>28</b>
5.1 APPLIED PROCEDURES / LIMIT	28
5.1.1 TEST PROCEDURE	28
5.1.2 DEVIATION FROM STANDARD	28
5.1.3 TEST SETUP	28
5.1.4 EUT OPERATION CONDITIONS	28
5.1.5 TEST RESULTS	29
<b>6 . PEAK OUTPUT POWER TEST</b>	<b>31</b>
6.1 APPLIED PROCEDURES / LIMIT	31
6.1.1 TEST PROCEDURE	31
6.1.2 DEVIATION FROM STANDARD	31
6.1.3 TEST SETUP	31
6.1.4 EUT OPERATION CONDITIONS	31
6.1.5 TEST RESULTS	32
<b>7 . 100 KHZ BANDWIDTH OF FREQUENCY BAND EDGE</b>	<b>33</b>
7.1 DEVIATION FROM STANDARD	33
7.2 TEST SETUP	33
7.3 EUT OPERATION CONDITIONS	34
7.4 TEST RESULTS	35
<b>8 . ANTENNA REQUIREMENT</b>	<b>37</b>
8.1 STANDARD REQUIREMENT	37
8.2 EUT ANTENNA	37
<b>9 . EUT TEST PHOTO</b>	<b>38</b>



## 1. SUMMARY OF TEST RESULTS

Test procedures according to the technical standards:

<b>FCC Part15 (15.247) , Subpart C</b>			
<b>Standard Section</b>	<b>Test Item</b>	<b>Judgment</b>	<b>Remark</b>
15.207	Conducted Emission	PASS	
15.247 (a)(2)	6dB Bandwidth	PASS	
15.247 (b)	Peak Output Power	PASS	
15.247 (c)	Radiated Spurious Emission	PASS	
15.247 (d)	Power Spectral Density	PASS	
15.205	Band Edge Emission	PASS	
15.203	Antenna Requirement	PASS	

**NOTE:**

(1) "N/A" denotes test is not applicable in this Test Report



## 1.1 TEST FACILITY

WH Technology Corp.

Add.: 7F., No.262, Sec. 3, Datong Rd., Xizhi Dist., New Taipei City 221, Taiwan (R.O.C.)

FCC Registration No.: TW1083

## 1.2 MEASUREMENT UNCERTAINTY

The reported uncertainty of measurement  $y \pm U$  where expanded uncertainty  $U$  is based on a standard uncertainty multiplied by a coverage factor of  $k=2$  providing a level of confidence of approximately **95 %**.

No.	Item	Uncertainty
1	Conducted Emission Test	$\pm 1.38\text{dB}$
2	RF power,conducted	$\pm 0.16\text{dB}$
3	Spurious emissions,conducted	$\pm 0.21\text{dB}$
4	All emissions,radiated(<1G)	$\pm 4.68\text{dB}$
5	All emissions,radiated(>1G)	$\pm 4.89\text{dB}$
6	Temperature	$\pm 0.5^\circ\text{C}$
7	Humidity	$\pm 2\%$



**2. GENERAL INFORMATION**

**2.1 GENERAL DESCRIPTION OF EUT**

Equipment	B-2 2.4GHz Wireless System	
Trade Name	NUX	
Model Name	B-2	
Serial Model	N/A	
Model Difference	N/A	
Product Description	The EUT is a B-2 2.4GHz Wireless System	
	Operation Frequency:	2418-2480MHz
	Modulation Type:	FSK
	Output Power(Conducted):	4.895 dBm (Max.)
	Antenna Gain (dBi)	4.66 dBi
Based on the application, features, or specification exhibited in User's Manual, the EUT is considered as an ITE/Computing Device. More details of EUT technical specification, please refer to the User's Manual.		
Channel List	Please refer to the Note 1.	
Battery	DC 3.7V 750 mAh by battery	
Connecting I/O Port(s)	Please refer to the User's Manual	

Note:

1. For a more detailed features description, please refer to the manufacturer's specifications or the User's Manual.

2.

**TEST FREQUENCY CHANNEL**

Low	2418 MHz
Middle	2442 MHz
High	2480 MHz

3.

Table for Filed Antenna

Ant	Brand	Model Name	Antenna Type	Connector	Gain (dBi)	NOTE
-----	-------	------------	--------------	-----------	------------	------



---

A	NUX	B-2	PCB antenna	/	4.66	PCB Antenna
---	-----	-----	-------------	---	------	-------------

## 2.2 DESCRIPTION OF TEST MODES

To investigate the maximum EMI emission characteristics generates from EUT, the test system was pre-scanning tested base on the consideration of following EUT operation mode or test configuration mode which possible have effect on EMI emission level. Each of these EUT operation mode(s) or test configuration mode(s) mentioned above was evaluated respectively.

Pretest Mode	Description
Mode 1	Link Mode

For Conducted Emission	
Final Test Mode	Description
Mode 2	Link Mode

For Radiated Emission	
Final Test Mode	Description
Mode 1	Link Mode

Note:

- (1) The measurements are performed at the highest, middle, lowest available channels.
- (2) The measurements are performed at all Bit Rate of Transmitter, the worst data was reported





**2.3 BLOCK DIGRAM SHOWING THE CONFIGURATION OF SYSTEM TESTED**

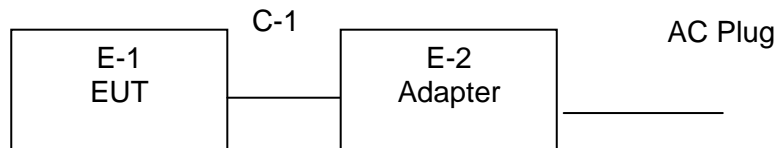



**2.4 DESCRIPTION OF SUPPORT UNITS(CONDUCTED MODE)**

The EUT has been tested as an independent unit together with other necessary accessories or support units. The following support units or accessories were used to form a representative test configuration during the tests.

Item	Equipment	Brand	Model/Type No.	Series No.	Note
E-1	B-2 2.4GHz Wireless System	NUX	B-2	N/A	EUT
E-2	Adapter	N/A	HW-050100E01	N/A	

Item	Shielded Type	Ferrite Core	Length	Note
C-1	NO	NO	1.0m	

Note:

- (1) The support equipment was authorized by Declaration of Confirmation.
- (2) For detachable type I/O cable should be specified the length in cm in 『Length』 column.



**2.5 EQUIPMENTS LIST FOR ALL TEST ITEMS**

For RF conducted test:

Equipment	Manufacturer	Model	Serial No.	Calibration Due
Signal Analyzer	Agilent	N9010A	MY48030494	2018/11/4
4 Ch. Simultaneous Sampling 14 Bits 2 MS/s	Agilent	U2531A	TW54063513	2018/11/4
X-series USB Peak and Average Power Sensor	Agilent	U2021XA	MY54080019	2018/11/4
vector Signal Generator	Agilent	E4438C	US44271917	2018/11/4
vector Signal Generator	Agilent	E4438C	MY49070163	2018/11/4
Dc Power Supply	GW	GPR-6030D	/	2018/11/4
Temperature & Humidity Chamber	GIANT FORCE	GTH-056P	GF-94454-1	2018/11/4
Wideband Radio Communication Tester	ROHDE&SCHWARZ	CMW500	120909	2018/11/4

For Radiated test:

Equipment	Manufacturer	Model	Serial No.	Calibration Due
Broadband TRILOG Antenna	Schwarabeck	VULB9163	9163-872	2018/11/14
Horn Antenna	Schwarzbeck	BBHA 9120 D	9120D-1145	2018/11/14
Amplifier	HP	8447D	3113A06150	2018/11/4
Amplifier	Agilent	8449B	3008A02400	2018/7/4
Test Receiver	Schwarabeck	ESPI7	100314	2018/11/4
Spectrum analyzer	Agilent	E4407B	MY41441082	2018/11/4
Signal Generator	R&S	SMT 06	832080/007	2018/11/4

Note: the calibration interval of the above test instruments is 12 months and the calibrations are traceable to international system unit (SI).



### 3. EMC EMISSION TEST

#### 3.1 CONDUCTED EMISSION MEASUREMENT

##### 3.1.1 POWER LINE CONDUCTED EMISSION Limits (Frequency Range 150KHz-30MHz)

Frequency (MHz)	Limit	
	Quasi-peak	Average
0.15-0.5	66 to 56	56 to 46
0.5-5	56	46
5-30	60	50

Note:

(1) Decreases with the logarithm of the frequency from 0.15MHz to 0.5MHz.

##### 1.1.1 Test method

1. The EUT was placed 0.8 meters from the horizontal ground plane with EUT being connected to the power mains through a line impedance stabilization network (LISN). All other support equipment powered from additional LISN(s). The LISN provide 50 Ohm/50uH of coupling impedance for the measuring instrument.

2. Interconnecting cables that hang closer than 40 cm to the ground plane shall be folded back and forth in the center forming a bundle 30 to 40 cm long.

3. I/O cables that are not connected to a peripheral shall be bundled in the center. The end of the cable may be terminated, if required, using the correct terminating impedance. The overall length shall not exceed 1 m.

4. LISN is at least 80 cm from nearest part of EUT chassis.

5. The resolution bandwidth of EMI test receiver is set at 9kHz.

##### 1.1.2 Test Result

Not application because of the EUT is power by battery.

The following table is the setting of the receiver

Receiver Parameters	Setting
Attenuation	10 dB
Start Frequency	0.15 MHz
Stop Frequency	30 MHz



---

IF Bandwidth	9 kHz
--------------	-------



### 3.1.2 TEST PROCEDURE

- a. The EUT was placed 0.8 meters from the horizontal ground plane with EUT being connected to the power mains through a line impedance stabilization network (LISN). All other support equipments powered from additional LISN(s). The LISN provide 50 Ohm/ 50uH of coupling impedance for the measuring instrument.
- b. Interconnecting cables that hang closer than 40 cm to the ground plane shall be folded back and forth in the center forming a bundle 30 to 40 cm long.
- c. I/O cables that are not connected to a peripheral shall be bundled in the center. The end of the cable may be terminated, if required, using the correct terminating impedance. The overall length shall not exceed 1 m.
- d. LISN at least 80 cm from nearest part of EUT chassis.
- e. For the actual test configuration, please refer to the related Item –EUT Test Photos.

### 3.1.3 DEVIATION FROM TEST STANDARD

No deviation

### 3.1.4 TEST SETUP

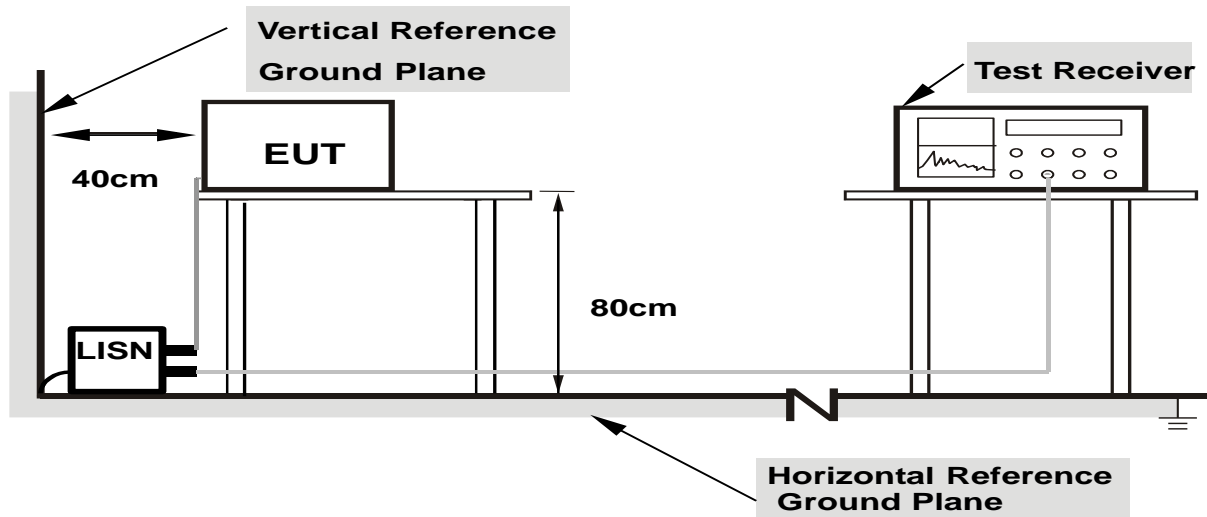

**Note: 1.Support units were connected to second LISN.**

**2.Both of LISNs (AMN) are 80 cm from EUT and at least 80 from other units and other metal planes**

### 3.1.5 EUT OPERATING CONDITIONS

The EUT was configured for testing in a typical fashion (as a customer would normally use it). The EUT has been programmed to continuously transmit during test. This operating condition was tested and used to collect the included data.



### 3.1.6 TEST RESULTS

EUT :	B-2 2.4GHz Wireless System	Model Name. :	B-2
Temperature :	26 °C	Relative Humidity :	54%
Pressure :	1010hPa	Phase :	L
Test Voltage :	DC 5Vfrom adapter AC 120V/60Hz	Test Mode :	Mode 2

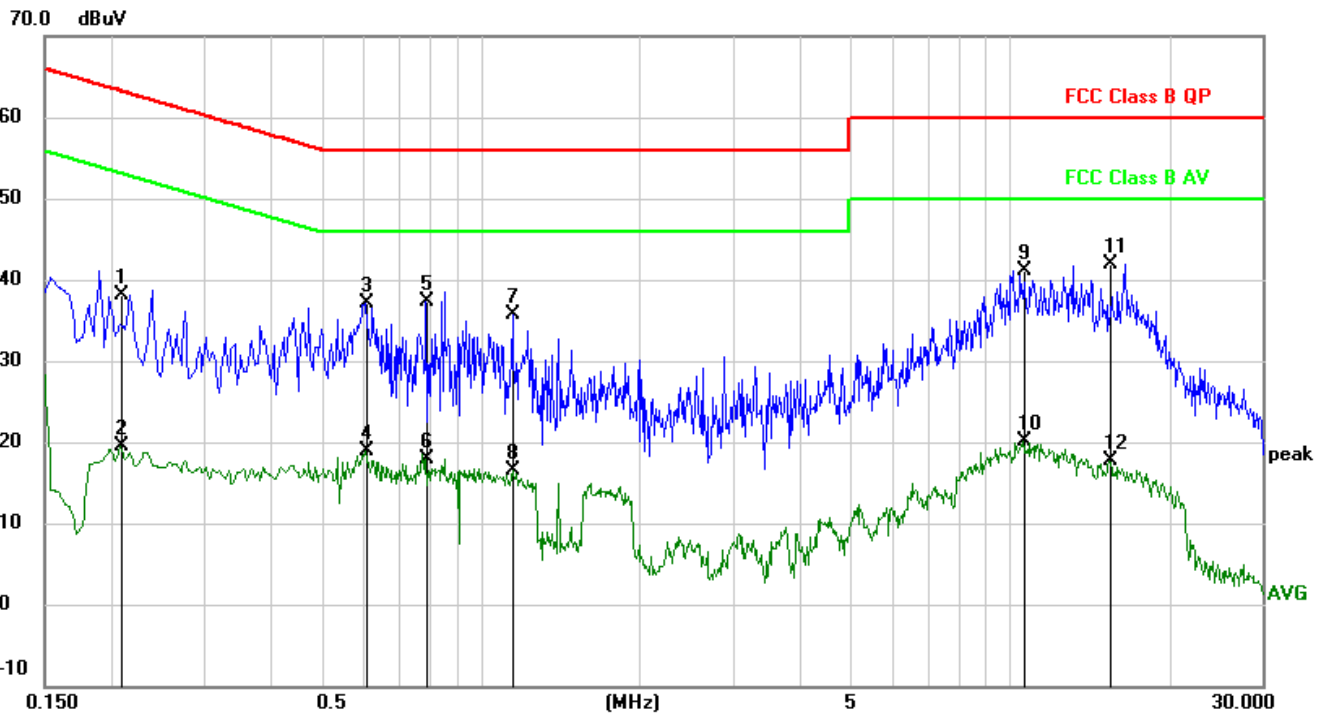

No.	Mk.	Freq. MHz	Reading Level dBuV	Correct Factor dB	Measure- ment dBuV	Limit dBuV	Over dB	Detector	Comment
1		0.2085	38.12	-0.03	38.09	63.26	-25.17	QP	
2		0.2085	19.44	-0.03	19.41	53.26	-33.85	AVG	
3		0.6045	37.09	-0.03	37.06	56.00	-18.94	QP	
4		0.6045	18.85	-0.03	18.82	46.00	-27.18	AVG	
5		0.7890	37.40	-0.03	37.37	56.00	-18.63	QP	
6		0.7890	18.01	-0.03	17.98	46.00	-28.02	AVG	
7		1.1490	35.79	-0.04	35.75	56.00	-20.25	QP	
8		1.1490	16.54	-0.04	16.50	46.00	-29.50	AVG	
9		10.6125	41.28	-0.10	41.18	60.00	-18.82	QP	
10		10.6125	20.26	-0.10	20.16	50.00	-29.84	AVG	
11	*	15.4005	42.11	-0.18	41.93	60.00	-18.07	QP	
12		15.4005	17.79	-0.18	17.61	50.00	-32.39	AVG	



EUT :	B-2 2.4GHz Wireless System	Model Name. :	B-2
Temperature :	26 °C	Relative Humidity :	54%
Pressure :	1010hPa	Phase :	N
Test Voltage :	DC 5V from adapter AC 120V/60Hz	Test Mode :	Mode 2

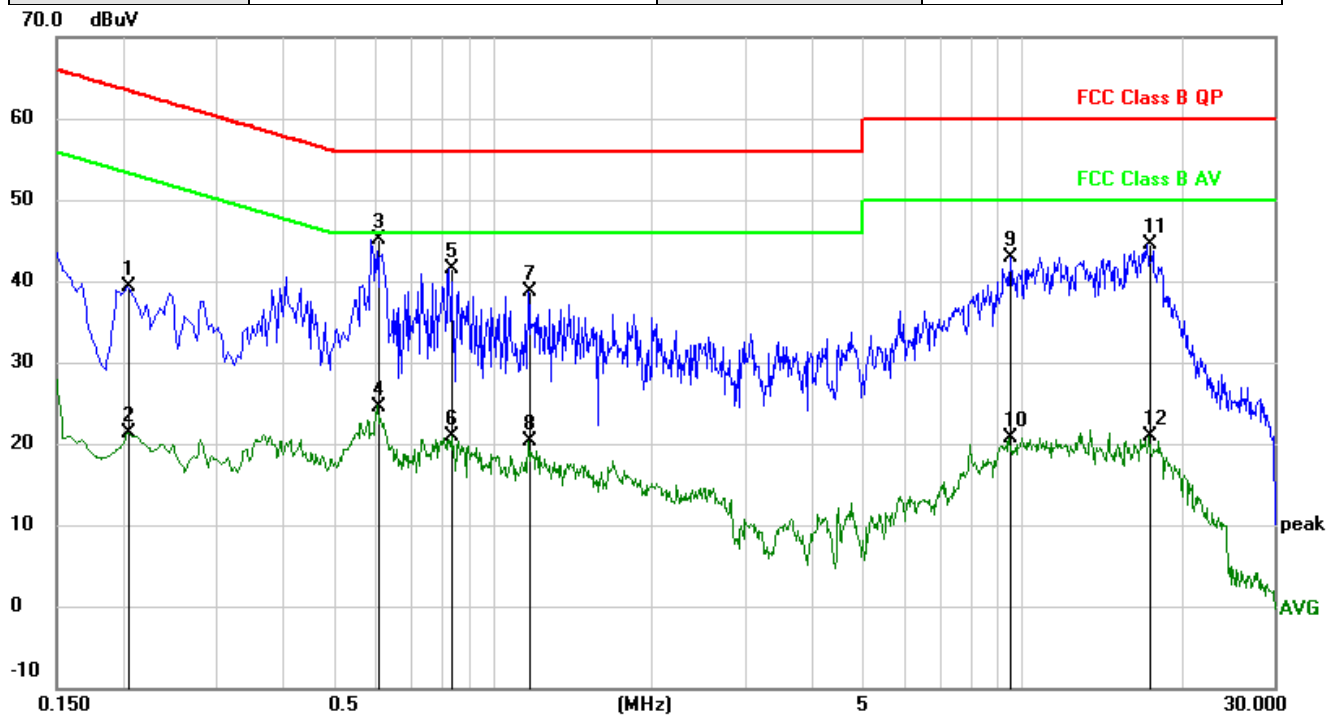

No.	Mk.	Freq. MHz	Reading Level dBuV	Correct Factor dB	Measure- ment dBuV	Limit dBuV	Over dB	Detector	Comment
1		0.2040	39.41	-0.03	39.38	63.45	-24.07	QP	
2		0.2040	21.33	-0.03	21.30	53.45	-32.15	AVG	
3	*	0.6045	45.05	-0.03	45.02	56.00	-10.98	QP	
4		0.6045	24.63	-0.03	24.60	46.00	-21.40	AVG	
5		0.8385	41.60	-0.03	41.57	56.00	-14.43	QP	
6		0.8385	20.88	-0.03	20.85	46.00	-25.15	AVG	
7		1.1715	38.76	-0.04	38.72	56.00	-17.28	QP	
8		1.1715	20.26	-0.04	20.22	46.00	-25.78	AVG	
9		9.4830	42.91	-0.08	42.83	60.00	-17.17	QP	
10		9.4830	20.87	-0.08	20.79	50.00	-29.21	AVG	
11		17.4705	44.63	-0.21	44.42	60.00	-15.58	QP	
12		17.4705	21.10	-0.21	20.89	50.00	-29.11	AVG	





### 3.2 RADIATED EMISSION MEASUREMENT

#### 3.2.1 RADIATED EMISSION LIMITS (Frequency Range 9kHz-1000MHz)

20dBc in any 100 kHz bandwidth outside the operating frequency band. In case the emission fall within the restricted band specified on 15.205(a), then the 15.209(a) limit in the table below has to be followed.

Frequencies (MHz)	Field Strength (micorvolts/meter)	Measurement Distance (meters)
0.009~0.490	2400/F(KHz)	300
0.490~1.705	24000/F(KHz)	30
1.705~30.0	30	30
30~88	100	3
88~216	150	3
216~960	200	3
Above 960	500	3

Spectrum Parameter	Setting
Attenuation	Auto
Start Frequency	1000 MHz
Stop Frequency	10th carrier harmonic
RB / VB (emission in restricted band)	1 MHz / 1 MHz for Peak, 1 MHz / 10Hz for Average

Receiver Parameter	Setting
Attenuation	Auto
Start ~ Stop Frequency	9kHz~150kHz / RB 200Hz for QP
Start ~ Stop Frequency	150kHz~30MHz / RB 9kHz for QP
Start ~ Stop Frequency	30MHz~1000MHz / RB 120kHz for QP

#### 3.2.2 TEST PROCEDURE

- a. The measuring distance of at 3 m shall be used for measurements at frequency up to 1GHz. For frequencies above 1GHz, any suitable measuring distance may be used.
- b. The EUT was placed on the top of a rotating table 0.8 meters above the ground at a 3 meter open area test site. The table was rotated 360 degrees to determine the position of the highest radiation.
- c. The height of the equipment or of the substitution antenna shall be 0.8 m; the height of the test antenna shall vary between 1 m to 4 m. Both horizontal and vertical polarizations of the antenna are set to make the measurement.



- d. The initial step in collecting conducted emission data is a spectrum analyzer peak detector mode pre-scanning the measurement frequency range. Significant peaks are then marked and then Quasi Peak detector mode re-measured.
- e. If the Peak Mode measured value compliance with and lower than Quasi Peak Mode Limit, the EUT shall be deemed to meet QP Limits and then no additional QP Mode measurement performed.
- f. For the actual test configuration, please refer to the related Item –EUT Test Photos.

Note:

Both horizontal and vertical antenna polarities were tested and performed pretest to three orthogonal axis. The worst case emissions were reported

### **3.2.3 DEVIATION FROM TEST STANDARD**

No deviation



### 3.2.4 TEST SETUP

(A) Radiated Emission Test-Up Frequency Below 30MHz

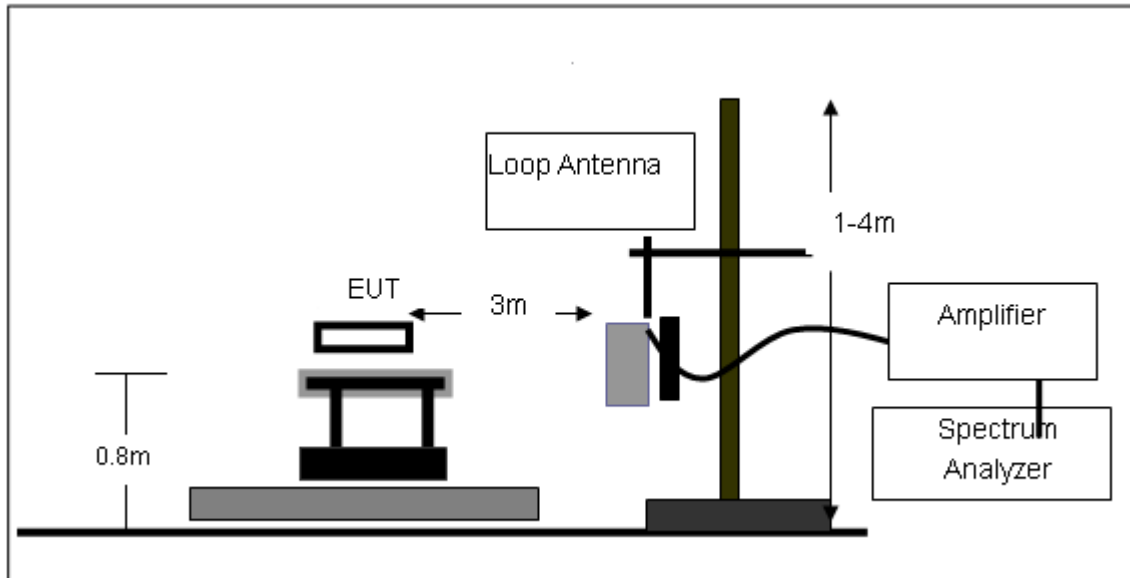

(B) Radiated Emission Test-Up Frequency 30MHz~1GHz

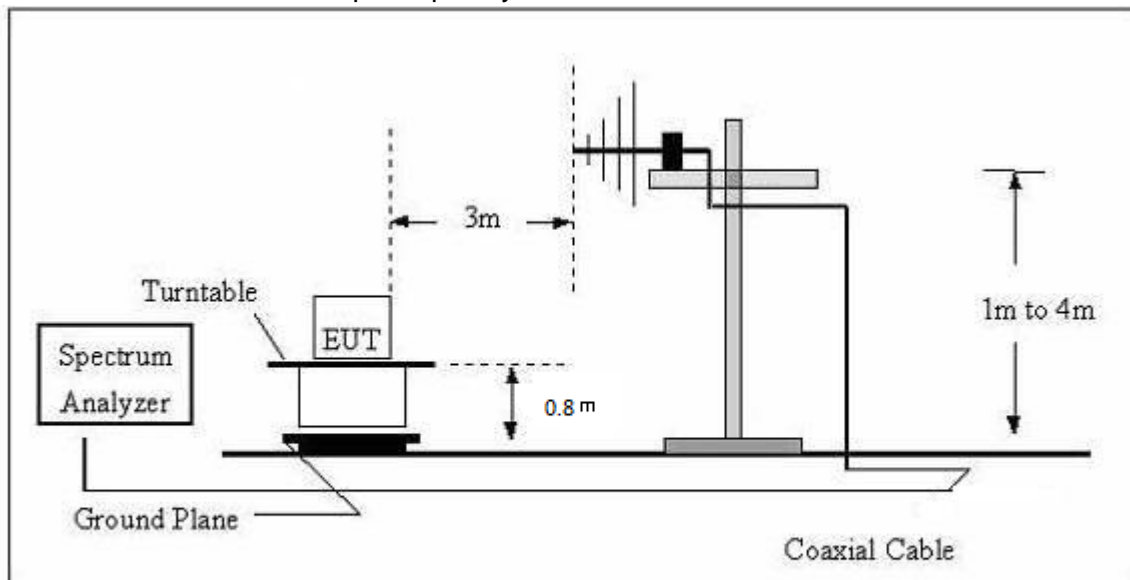



(C) Radiated Emission Test-Up Frequency Above 1GHz

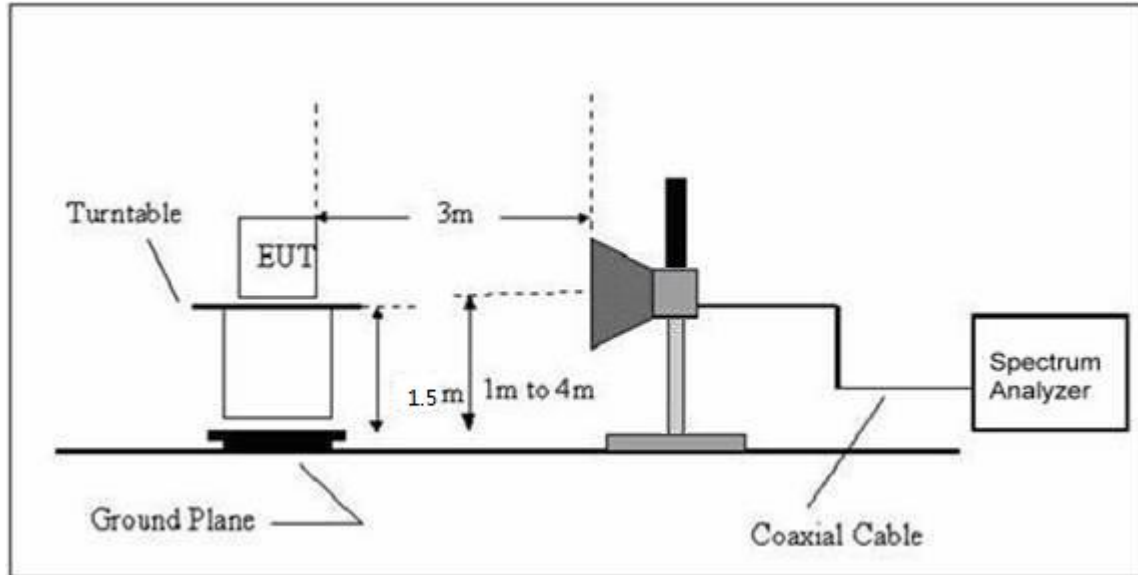

**3.2.5 EUT OPERATING CONDITIONS**

The EUT tested system was configured as the statements of 2.4 Unless otherwise a special operating condition is specified in the follows during the testing.



**3.2.6 TEST RESULTS (BETWEEN 9KHZ – 30 MHZ)**

EUT:	B-2 2.4GHz Wireless System	Model Name. :	B-2
Temperature:	20 °C	Relative Humidity:	48%
Pressure:	1010 hPa	Test Voltage :	DC 5V from adapter
Test Mode :	TX	Polarization :	--

Freq. (MHz)	Reading (dBuV/m)	Limit (dBuV/m)	Margin (dB)	State P/F
--	--	--	--	PASS
--	--	--	--	PASS

**NOTE:**

The amplitude of spurious emissions which are attenuated by more than 20dB below the permissible value has no need to be reported.

Distance extrapolation factor =  $40 \log(\text{specific distance}/\text{test distance})(\text{dB})$ ;

Limit line = specific limits(dBuv) + distance extrapolation factor.



**3.2.7 TEST RESULTS (BETWEEN 30MHZ – 1GHZ)**

EUT :	B-2 2.4GHz Wireless System	Model Name :	B-2
Temperature :	20 °C	Relative Humidity :	48%
Pressure:	1010 hPa	Test Voltage :	DC 5V from adapter
Test Mode :	TX		

No.	Frequency (MHz)	Reading (dBUV)	Factor (dB)	Emission Level (dBUV/m)	Limits (dBUV/m)	Margin (dB)	Detector Type	Result
Polarization: Vertical								
1	119.4360	17.83	12.08	27.88	43.5	15.62	QP	Pass
2	128.1124	15.45	12.72	27.65	43.5	15.45	QP	Pass
3	170.7926	21.81	10.35	31.57	43.5	11.43	QP	Pass
4	341.9786	12.03	16.14	28.22	46	17.78	QP	Pass
5	468.8771	16.19	19.69	36.52	46	9.78	QP	Pass
6	935.5462	10.82	29.47	39.85	46	6.17	QP	Pass
Polarization: Horizontal								
1	170.7943	26.63	10.37	36.98	43.5	6.57	QP	Pass
2	341.9786	23.73	16.15	40.02	46	5.98	QP	Pass
3	468.8781	20.92	19.69	40.12	46	5.81	QP	Pass
4	726.8032	14.13	26.43	40.73	46	5.29	QP	Pass
5	813.1114	16.73	26.75	42.58	46	3.42	QP	Pass
6	854.0257	12.54	27.81	40.04	46	5.91	QP	Pass



### 3.2.8 TEST RESULTS (1G-25GHZ)

EUT :	B-1 2.4GHz Wireless System	Model Name :	B-1
Temperature :	20 °C	Relative Humidity :	48%
Pressure:	1010 hPa	Test Voltage :	DC 5V from adapter
Test Mode :	TX mode		

No.	Frequency (MHz)	Reading (dBUV/m)	Factor dB/m	Emission Level (dBUV/m)	Limit (dBUV/m)	Margin (dB)	Detector	Result
Polarization: Vertical								
1	2830.000	50.70	-7.69	43.01	74.00	-30.99	Peak	Pass
2	3075.000	49.07	-6.61	42.46	74.00	-31.54	Peak	Pass
3	3370.000	50.62	-6.19	44.43	74.00	-29.57	Peak	Pass
4	3675.000	48.61	-5.38	43.23	74.00	-30.77	Peak	Pass
5	4190.000	49.62	-5.37	44.25	74.00	-29.75	Peak	Pass
6	4840.000	64.64	-9.11	55.53	74.00	-18.47	AVG	Pass
7	2830.000	50.70	-7.69	43.01	74.00	-30.99	Peak	Pass
Polarization: Horizontal								
1	3370.000	50.62	-6.19	44.43	74.00	-29.57	Peak	Pass
2	3795.000	48.79	-4.95	43.84	74.00	-30.16	Peak	Pass
3	4190.000	49.62	-5.37	44.25	74.00	-29.75	Peak	Pass
4	4840.000	64.64	-9.11	55.53	74.00	-18.47	Peak	Pass
5	5085.000	47.92	-9.83	38.09	74.00	-35.91	Peak	Pass
6	5690.000	47.02	-8.53	38.49	74.00	-35.51	Peak	Pass

Note: The radiated emission above 6GHz, which the level of test result was background, so it was not reported here.



## BAND EDGE(Radiated)

Frequency (MHz)	Meter Reading (dB $\mu$ V)	Factor (dB)	Emission Level (dB $\mu$ V/m)	Limits (dB $\mu$ V/m)	Margin (dB)	Detector Type	Comment
GFSK							
2390	54.39	-12.78	41.61	74	-32.39	peak	Vertical
2390	51.18	-12.78	38.40	74	-35.60	peak	Horizontal
2483.5	53.74	-12.78	40.96	74	-33.04	peak	Vertical
2483.5	53.90	-12.78	41.12	74	-32.88	peak	Horizontal
$\pi/4$ -DQPSK							
2390	51.86	-13.06	38.80	74	-35.20	peak	Vertical
2390	53.69	-13.06	40.63	74	-33.37	peak	Horizontal
2483.5	52.50	-12.78	39.72	74	-34.28	peak	Vertical
2483.5	50.96	-12.78	38.18	74	-35.82	peak	Horizontal
8-DPSK							
2390	53.65	-13.06	40.59	74	-33.41	peak	Vertical
2390	53.63	-13.06	40.57	74	-33.43	peak	Horizontal
2483.5	52.29	-12.78	39.51	74	-34.49	peak	Vertical
2483.5	54.27	-12.78	41.49	74	-32.51	peak	Horizontal

NOTE: The PK value is less than the AV value, AV value is not required.





#### 4. POWER SPECTRAL DENSITY TEST

##### 4.1 APPLIED PROCEDURES / LIMIT

FCC Part15 (15.247) , Subpart C				
Section	Test Item	Limit	Frequency Range (MHz)	Result
15.247	Power Spectral Density	8 dBm (in any 3KHz)	2400-2483.5	PASS

##### 4.1.1 TEST PROCEDURE

1. Set analyzer center frequency to DTS channel center frequency.
2. Set the span to 1.5 times the DTS channel bandwidth.
3. Set the RBW  $\geq$  3 kHz.
4. Set the VBW  $\geq$  3 x RBW.
5. Detector = peak.
6. Sweep time = auto couple.
7. Trace mode = max hold.
8. Allow trace to fully stabilize.
9. Use the peak marker function to determine the maximum amplitude level.
10. If measured value exceeds limit, reduce RBW (no less than 3 kHz) and repeat.

##### 4.1.2 DEVIATION FROM STANDARD

No deviation.

##### 4.1.3 TEST SETUP



##### 4.1.4 EUT OPERATION CONDITIONS

The EUT tested system was configured as the statements of 2.1 Unless otherwise a special operating condition is specified in the follows during the testing.



**4.1.5 TEST RESULTS**

EUT :	B-2 2.4GHz Wireless System	Model Name :	B-2
Temperature :	25 °C	Relative Humidity :	60%
Pressure :	1015 hPa	Test Voltage :	DC 5V from adapter
Test Mode :	TX Mode		

Frequency	Power Density (dBm)	Limit (dBm)	Result
2418 MHz	-4.900	8	PASS
2442 MHz	-4.221	8	PASS
2480 MHz	-5.387	8	PASS

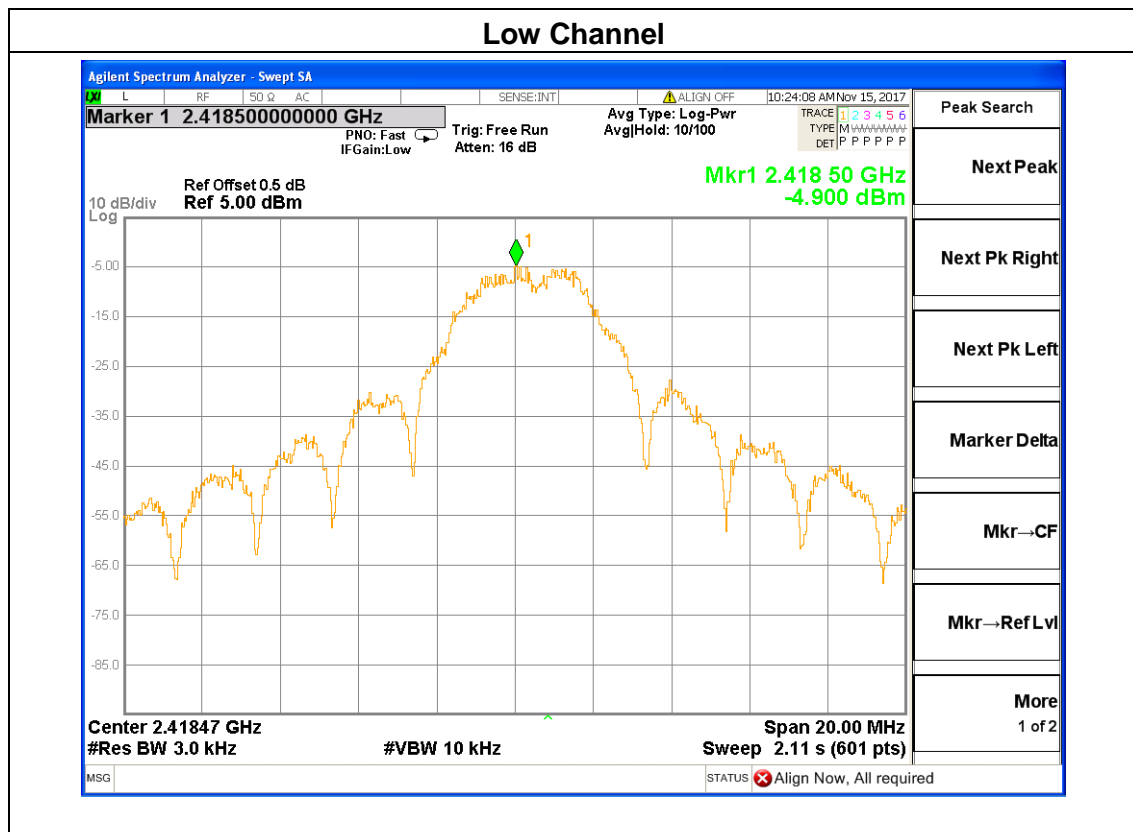

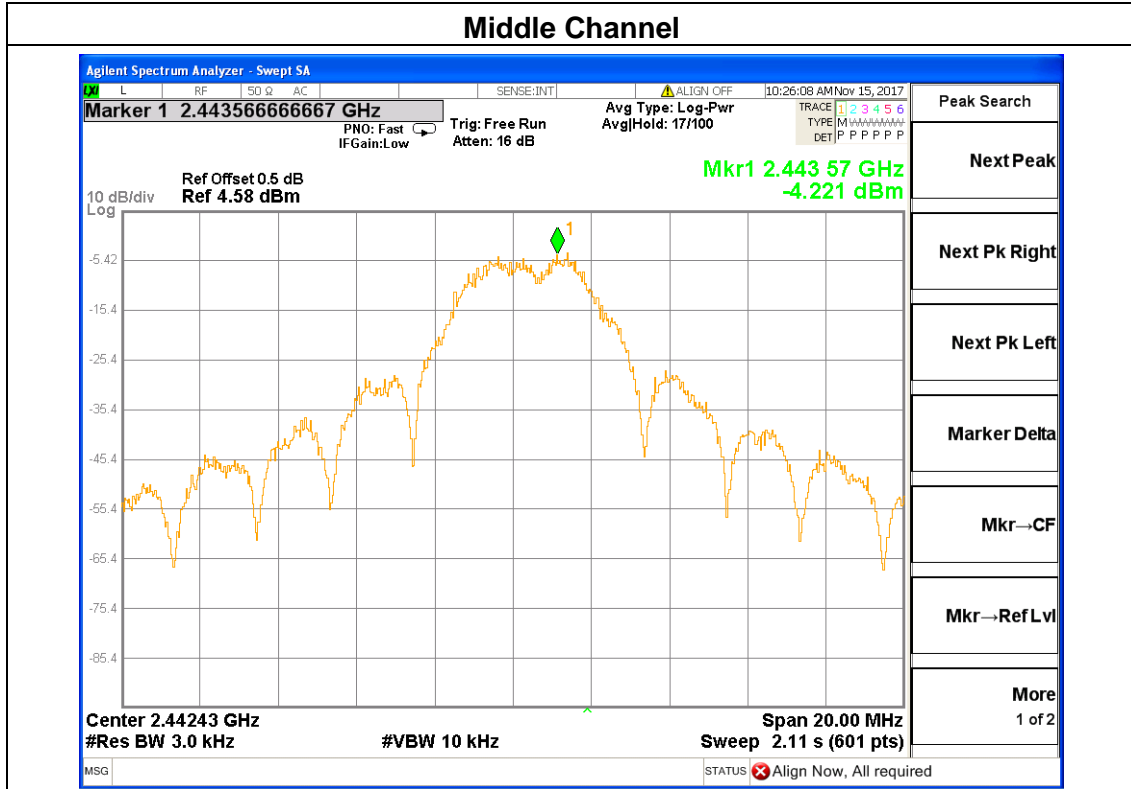



## 5. BANDWIDTH TEST

### 5.1 APPLIED PROCEDURES / LIMIT

FCC Part15 (15.247) , Subpart C				
Section	Test Item	Limit	Frequency Range (MHz)	Result
15.247(a)(2)	Bandwidth	$\geq 500\text{KHz}$ (6dB bandwidth)	2400-2483.5	PASS

#### 5.1.1 TEST PROCEDURE

1. Set RBW= 100 kHz.
2. Set the video bandwidth (VBW)  $\geq 3 \times$  RBW.
3. Detector = Peak.
4. Trace mode = max hold.
5. Sweep = auto couple.
6. Allow the trace to stabilize.
7. Measure the maximum width of the emission that is constrained by the frequencies associated with the two outermost amplitude points (upper and lower) that are attenuated by 6 dB relative to the maximum level measured in the fundamental emission.

#### 5.1.2 DEVIATION FROM STANDARD

No deviation.

#### 5.1.3 TEST SETUP

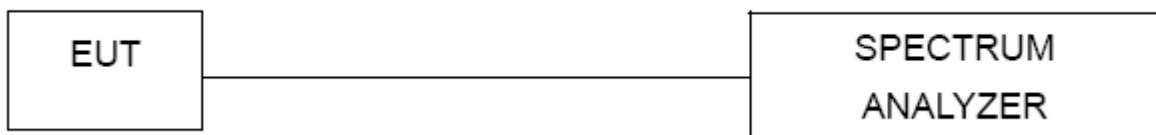

#### 5.1.4 EUT OPERATION CONDITIONS

The EUT tested system was configured as the statements of 2.4 Unless otherwise a special operating condition is specified in the follows during the testing.



**5.1.5 TEST RESULTS**

EUT :	B-2 2.4GHz Wireless System	Model Name :	B-2
Temperature :	25 °C	Relative Humidity :	60%
Pressure :	1012 hPa	Test Voltage :	DC 5Vfrom adapter
Test Mode :	TX Mode		

Channel	Frequency (MHz)	6dB bandwidth (KHz)	Limit (kHz)	Result
Low	2418	2776	500	Pass
Middle	2442	2715	500	Pass
High	2480	2832	500	Pass

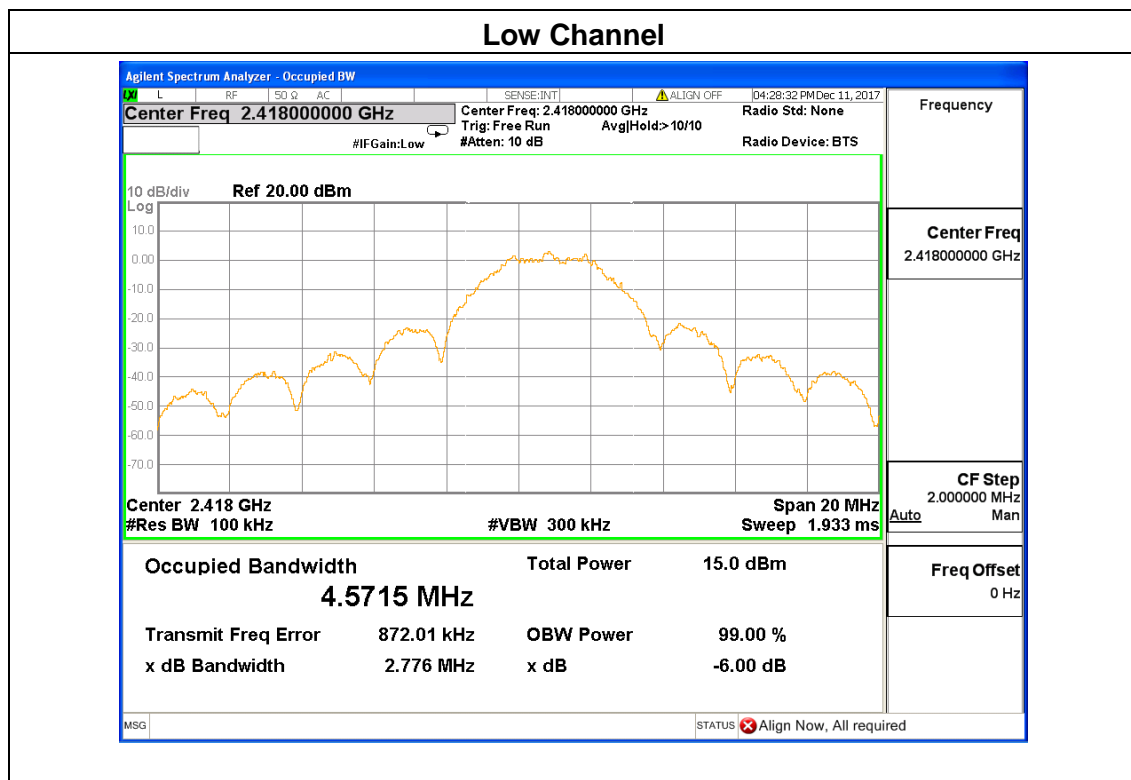

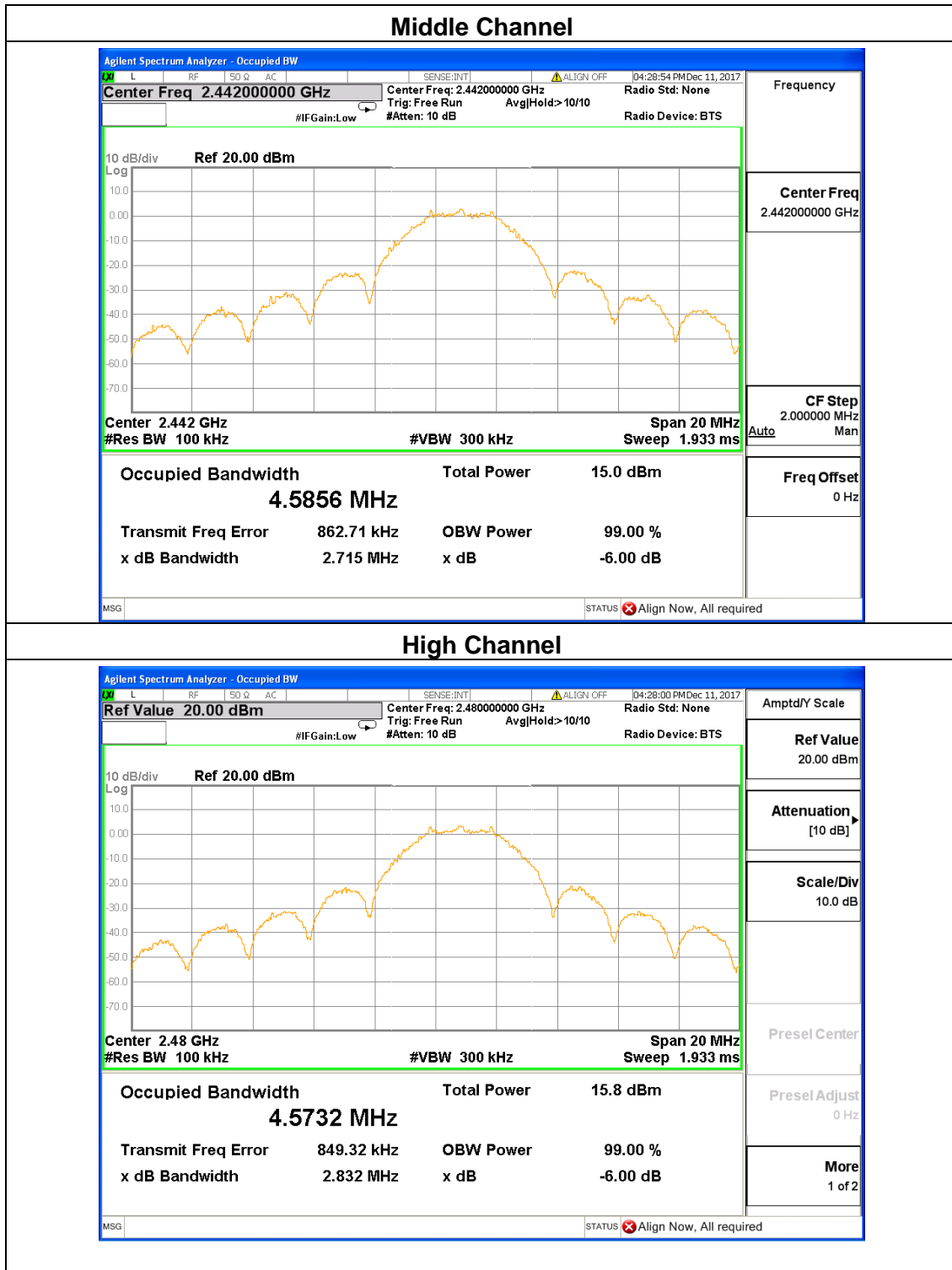



## 6. PEAK OUTPUT POWER TEST

### 6.1 APPLIED PROCEDURES / LIMIT

FCC Part15 (15.247) , Subpart C				
Section	Test Item	Limit	Frequency Range (MHz)	Result
15.247(b)(3)	Peak Output Power	1 watt or 30dBm	2400-2483.5	PASS

#### 6.1.1 TEST PROCEDURE

- a. The EUT was directly connected to the Power meter

#### 6.1.2 DEVIATION FROM STANDARD

No deviation.

#### 6.1.3 TEST SETUP



#### 6.1.4 EUT OPERATION CONDITIONS

The EUT tested system was configured as the statements of 2.4 Unless otherwise a special operating condition is specified in the follows during the testing.



**6.1.5 TEST RESULTS**

EUT :	B-2 2.4GHz Wireless System	Model Name :	B-2
Temperature :	25 °C	Relative Humidity :	60%
Pressure :	1012 hPa	Test Voltage :	DC 5Vfrom adapter
Test Mode :	TX Mode		

<b>FSK Mode</b>			
Test Channe	Frequency	Maximum Conducted Output Power(PK)	LIMIT
	(MHz)	(dBm)	dBm
Low	2418	4.772	30
Middel	2442	4.895	30
High	2480	4.831	30

'''





## **7. 100 KHZ BANDWIDTH OF FREQUENCY BAND EDGE**

### **APPLICABLE STANDARD**

In any 100 kHz bandwidth outside the frequency band in which the spread spectrum or digitally modulated intentional radiator is operating, the radio frequency power that is produced by the intentional radiator shall be at least 20 dB below that in the 100 kHz bandwidth within the band that contains the highest level of the desired power, based on either an RF conducted or a radiated measurement, provided the transmitter demonstrates compliance with the peak conducted power limits. If the transmitter complies with the conducted power limits based on the use of RMS averaging over a time interval, as permitted under paragraph (b)(3) of this section, the attenuation required under this paragraph shall be 30 dB instead of 20 dB. Attenuation below the general limits specified in §15.209(a) is not required. In addition, radiated emissions which fall in the restricted bands, as defined in §15.205(a), must also comply with the radiated emission limits specified in §15.209(a) (see §15.205(c)).

### **TEST PROCEDURE**

- a) Check the calibration of the measuring instrument using either an internal calibrator or a known signal from an external generator.
- b) Position the EUT without connection to measurement instrument. Turn on the EUT and connect its antenna terminal to measurement instrument via a low loss cable. Then set it to any one measured frequency within its operating range, and make sure the instrument is operated in its linear range.
- c) Set RBW to 100 kHz and VBW of spectrum analyzer to 300 kHz with a convenient frequency span including 100 kHz bandwidth from band edge.
- d) Measure the highest amplitude appearing on spectral display and set it as a reference level. Plot the graph with marking the highest point and edge frequency.
- e) Repeat above procedures until all measured frequencies were complete.

### **7.1 DEVIATION FROM STANDARD**

No deviation.

### **7.2 TEST SETUP**

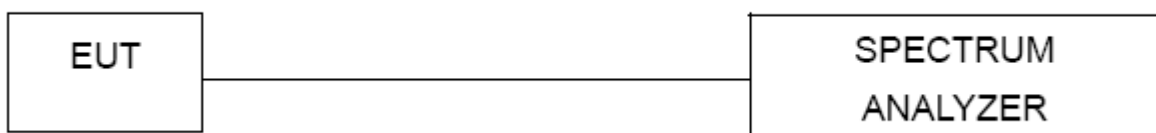



### **7.3 EUT OPERATION CONDITIONS**

The EUT tested system was configured as the statements of 2.4 Unless otherwise a special operating condition is specified in the follows during the testing.



**7.4 TEST RESULTS**

EUT :	B-2 2.4GHz Wireless System	Model Name :	B-2
Temperature :	25 °C	Relative Humidity :	60%
Pressure :	1012 hPa	Test Voltage :	DC 5Vfrom adapter

Frequency Band	Delta Peak to band emission (dBc)	> Limit (dBc)	Result
FSK mode			
Left-band	61.492	20	Pass
Right-band	-22.447	20	Pass



## BLE: Band Edge, Left Side

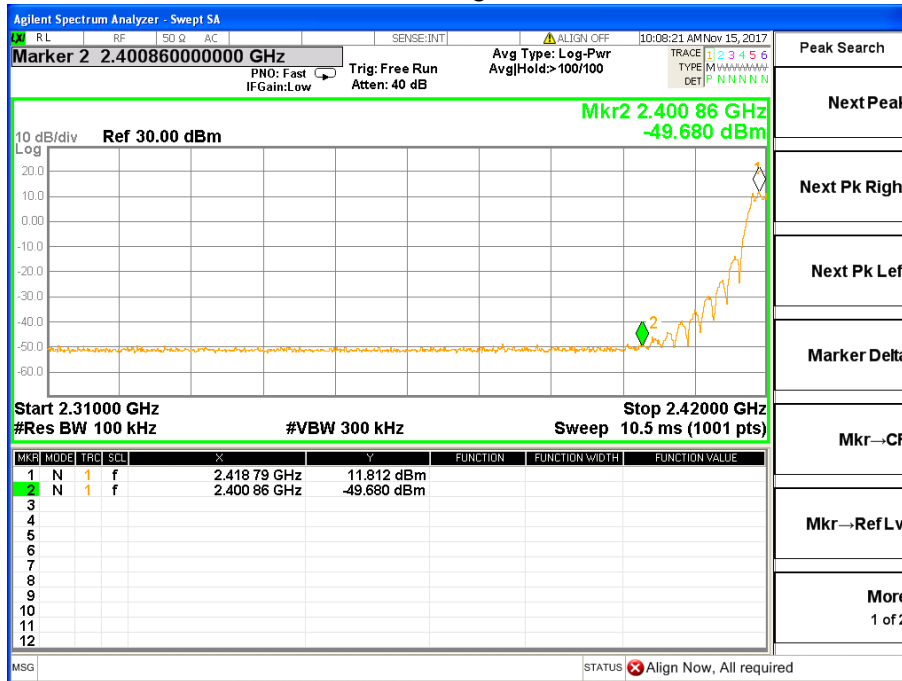

## BLE: Band Edge, Right Side

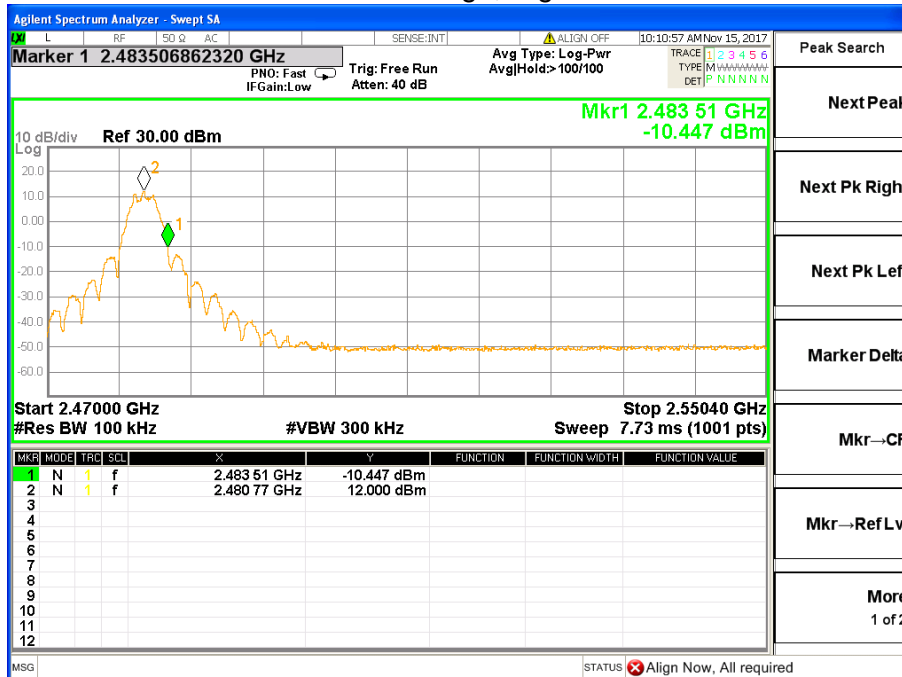



## **8. ANTENNA REQUIREMENT**

### **8.1 STANDARD REQUIREMENT**

15.203 requirement: For intentional device, according to 15.203: an intentional radiator shall be designed to ensure that no antenna other than that furnished by the responsible party shall be used with the device.

### **8.2 EUT ANTENNA**

The EUT antenna is PCB antenna. It comply with the standard requirement. In case of replacement of broken antenna the same antenna type must be used.



**9. EUT TEST PHOTO**

**Radiated Measurement Photos**

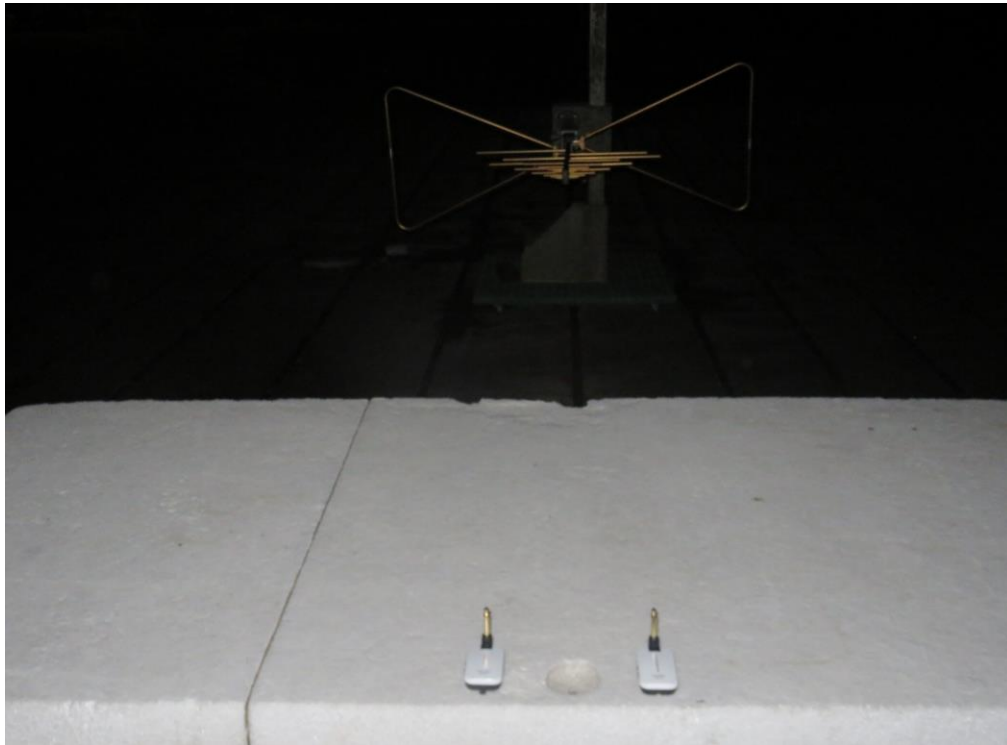



**CONDUCTED EMISSION Photos**

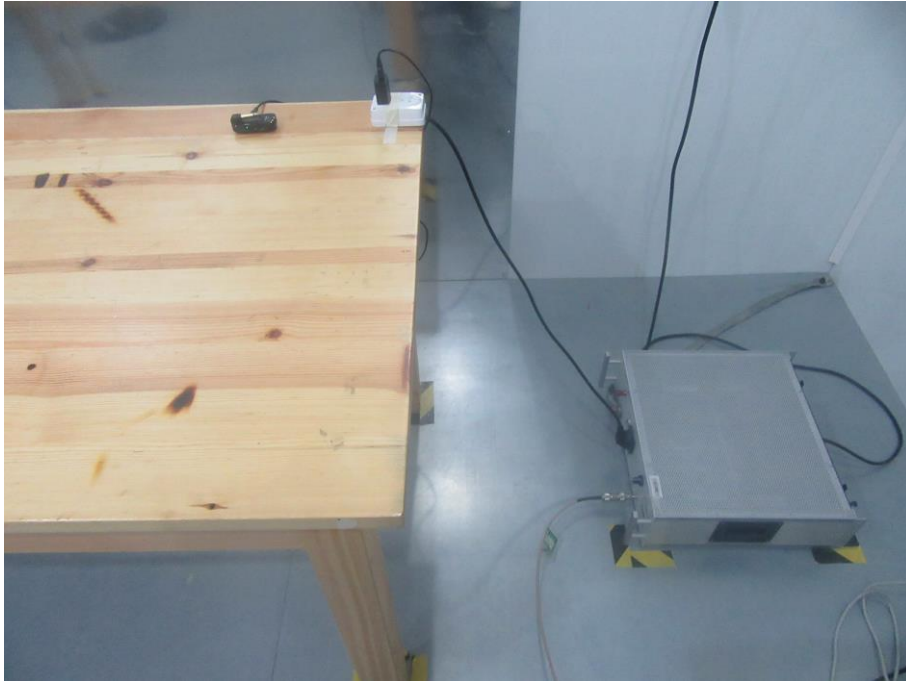

**----END OF REPORT----**