



Test Report

Report No.: MTi201225011-08E2

Date of issue: Apr. 27, 2021

Applicant: Cherub Technology Co., Ltd

Product name: Portable Battery-Operated
Acoustic Amp

Model(s): AC-25, SA-25

FCC ID: 2AOAA-AC-25

Shenzhen Microtest Co., Ltd.
<http://www.mtitest.com>



Instructions

1. The report shall not be partially reproduced without the written consent of the laboratory;
2. The test results of this report are only responsible for the samples submitted;
3. This report is invalid without the seal and signature of the laboratory;
4. This report is invalid if transferred, altered or tampered with in any form without authorization;
5. Any objection to this report shall be submitted to the laboratory within 15 days from the date of receipt of the report.



Table of Contents

1. GENERAL INFORMATION.....	6
1.1. DESCRIPTION OF EUT	6
1.2. OPERATION CHANNEL LIST	6
1.3. TEST CHANNEL LIST	7
1.4. ANCILLARY EQUIPMENT LIST	7
1.5. DESCRIPTION OF SUPPORT UNITS	7
2. SUMMARY OF TEST RESULTS.....	8
3. TEST FACILITIES AND ACCREDITATIONS	9
3.1. TEST LABORATORY	9
3.2. ENVIRONMENTAL CONDITIONS	9
3.3. MEASUREMENT UNCERTAINTY	9
3.4. TEST SOFTWARE	9
4. EQUIPMENT LIST	10
5. TEST RESULT	11
5.1. ANTENNA REQUIREMENT	11
5.1.1 <i>Standard Requirement</i>	11
5.1.2 <i>EUT Antenna</i>	11
5.2. PEAK OUTPUT POWER TEST	12
5.2.1 <i>Limit</i>	12
5.2.2 <i>Test setup</i>	12
5.2.3 <i>Test Procedure</i>	12
5.2.4 <i>Test Results</i>	12
5.3. CONDUCTED EMISSION	15
5.3.1 <i>Limits</i>	15
5.3.2 <i>Test Setup</i>	15
5.3.3 <i>Test Procedure</i>	16
5.3.4 <i>Test Results</i>	16
5.4. RADIATED SPURIOUS EMISSION.....	21
5.4.1 <i>Limits</i>	21
5.4.2 <i>Test Setup</i>	22
5.4.3 <i>Test Procedure</i>	23
5.4.4 <i>Test Results</i>	24
5.4.4.1 <i>Band edge-radiated</i>	28
5.4.4.2 <i>Spurious Emission in Restricted Band 3260MHz-18000MHz</i>	29
5.5. POWER SPECTRAL DENSITY TEST	30
5.5.1 <i>Limit</i>	30
5.5.2 <i>Test Procedure</i>	30
5.5.3 <i>Test Setup</i>	30
5.5.4 <i>Test Results</i>	31
5.6. 6DB BANDWIDTH	33
5.6.1 <i>Limit</i>	33
5.6.2 <i>Test Procedure</i>	33
5.6.3 <i>Test Setup</i>	33
5.6.4 <i>Test Result</i>	33
5.7. DUTY CYCLE	36
5.7.1 <i>Conformance Limit</i>	36
5.7.2 <i>Measuring Instruments</i>	36
5.7.3 <i>Test Setup</i>	36
5.7.4 <i>Test Procedure</i>	36
5.7.5 <i>Test Results</i>	37



5.8	CONDUCTED BAND EDGE.....	39
5.8.1	<i>Limits</i>	39
5.8.2	<i>Test Setup</i>	39
5.8.3	<i>Test Procedure</i>	39
5.8.4	<i>Test Result</i>	39
5.9	SPURIOUS RF CONDUCTED EMISSIONS	41
5.9.1	<i>Conformance Limit</i>	41
5.9.2	<i>Measuring Instruments</i>	41
5.9.3	<i>Test Setup</i>	41
5.9.4	<i>Test Procedure</i>	41
5.9.5	<i>Test Results</i>	41
	PHOTOGRAPHS OF THE TEST SETUP	44
	PHOTOGRAPHS OF THE EUT	46



TEST RESULT CERTIFICATION

Applicant's name	Cherub Technology Co., Ltd
Address	Room507, Block 1, Nanhai E-Cool, No. 6 Xinghua Road, Shekou, Nanshan District, Shenzhen City, Guangdong Province, China, 518067
Manufacturer's Name	Cherub Technology Co., Ltd
Address	Room507, Block 1, Nanhai E-Cool, No. 6 Xinghua Road, Shekou, Nanshan District, Shenzhen City, Guangdong Province, China, 518067
Factory's Name:	Cherub Technology Co., Ltd (Zhuhai High-tech Park)
Address:	No.10, Keji No.9Rd, Tangjiawan Town, Zhuhai National Hi-tech Industrial Development Zone, Zhuhai City, Guangdong Province, China, 519080

Product description

Product name	Portable Battery-Operated Acoustic Amp
Trademark	NUX
Model Name	AC-25
Serial Model	SA-25
Standards	FCC Part 15.247
Test procedure	ANSI C63.10-2013

Date of Test

Date (s) of performance of tests	Apr. 10, 2021 ~Apr. 27, 2021
Test Result	Pass

This device described above has been tested by Shenzhen Microtest Co., Ltd. and the test results show that the equipment under test (EUT) is in compliance with the FCC requirements. And it is applicable only to the tested sample identified in the report.

Testing Engineer : 
(Danny Xu)

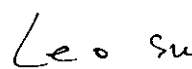
Technical Manager : 
(Leo Su)

Authorized Signatory : 
(Tom Xue)



1. General Information

1.1. Description of EUT

Product name:	Portable Battery-Operated Acoustic Amp
Model name:	AC-25
Serial model:	SA-25
Difference in series models:	All the models are the same circuit and RF module, except the model No.
Operation frequency:	2402-2480MHz
Modulation type:	GFSK
Bit Rate of transmitter:	1 Mbps
Antenna type:	PCB Antenna
Antenna gain:	1.5dBi
Max. output power:	4.730dBm
Hardware version:	V1.0
Software version:	V1.0x
Power supply:	DC 15V from adapter AC 120V/60Hz or DC 11.1V from battery
Adapter information:	MODEL: ADS-40NP-12-1 15038E INPUT: 100V-240V~ 50/60Hz Max. / 1.0A OUTPUT: 15.0V 2.5A 37.5W
Battery:	DC 11.1V 3000mAH
EUT serial number:	MTi201225011-08-S0001

1.2. Operation channel list

Channel No.	Frequency (MHz)	Channel No.	Frequency (MHz)	Channel No.	Frequency (MHz)	Channel No.	Frequency (MHz)
0	2402	10	2422	20	2442	30	2462
1	2404	11	2424	21	2444	31	2464
2	2406	12	2426	22	2446	32	2466
3	2408	13	2428	23	2448	33	2468
4	2410	14	2430	24	2450	34	2470
5	2412	15	2432	25	2452	35	2472
6	2414	16	2434	26	2454	36	2474
7	2416	17	2436	27	2456	37	2476
8	2418	18	2438	28	2458	38	2478
9	2420	19	2440	29	2460	39	2480



1.3. Test channel list

Channel	Channel	Frequency (MHz)
Low	00	2402
Middle	19	2440
High	39	2480

1.4. Ancillary equipment list

Equipment	Model	S/N	Manufacturer	Certificate type
/	/	/	/	/

1.5. Description of Support Units

The EUT has been tested as an independent unit together with other necessary accessories or support units. The following support units or accessories were used to form a representative test configuration during the tests.

Item	Equipment	Brand	Model/Type No.	Series No.	Note
1	Adapter	/	GA-QC810	/	
2	USB Cable	/	/	/	

Note:

- (1)The support equipment was authorized by Declaration of Confirmation.
- (2)For detachable type I/O cable should be specified the length in cm in 『Length』 column.



2. Summary of Test Results

Test procedures according to the technical standards:

No.	Standard Section	Test Item	Result	Remark
1	15.203	Antenna Requirement	Pass	
2	15.247 (b)	Peak Output Power	Pass	
3	15.207	Conducted Emission	Pass	
4	15.247 (d) & 15.209	Radiated Spurious Emission	Pass	
5	15.247 (e)	Power Spectral Density	Pass	
6	15.247 (a)(2)	6dB Bandwidth	Pass	
7	558074 D01 15.247 Meas Guidance v05r02 Chapter 6	Duty Cycle	Pass	
8	15.205	Band Edge Emission	Pass	
9	15.247(d)	Spurious RF Conducted Emissions	Pass	

3. Test Facilities and Accreditations

3.1. Test laboratory

Test Laboratory	Shenzhen Microtest Co., Ltd
Location	101, No. 7, Zone 2, Xinxing Industrial Park, Fuhai Avenue, Xinhe Community, Fuhai Street, Bao' an District, Shenzhen, Guangdong, China.
FCC Registration No.:	448573

3.2. Environmental conditions

Temperature:	15°C~35°C
Humidity	20%~75%
Atmospheric pressure	98kPa~101kPa

3.3. Measurement uncertainty

The reported uncertainty of measurement $y \pm U$ where expanded uncertainty U is based on a standard uncertainty multiplied by a coverage factor of $k=2$ providing a level of confidence of approximately 95 %

No.	Item	Uncertainty
1	Conducted Emission Test	$\pm 1.38\text{dB}$
2	RF power, conducted	$\pm 0.16\text{dB}$
3	Spurious emissions, conducted	$\pm 0.21\text{dB}$
4	All emissions, radiated(<1G)	$\pm 4.68\text{dB}$
5	All emissions, radiated(>1G)	$\pm 4.89\text{dB}$
6	Temperature	$\pm 0.5^\circ\text{C}$
7	Humidity	$\pm 2\%$

3.4. Test software

Software Name	Manufacturer	Model	Version
Bluetooth and WiFi Test System	Shenzhen JS tonskend co., ltd	JS1120-3	2.5.77.0418



4. Equipment list

Equipment No.	Equipment Name	Manufacturer	Model	Serial No.	Calibration date	Due date
MTI-E043	EMI Test Receiver	Rohde&schwarz	ESCI7	101166	2020/06/04	2021/06/03
MTI-E044	TRILOG Broadband Antenna	schwarzbeck	VULB 9163	9163-1338	2020/06/05	2021/06/04
MTI-E047	Amplifier	Hewlett-Packard	8447F	3113A06150	2020/06/04	2021/06/03
MTI-E089	ESG Vector Signal Generator	Agilent	N5182A	MY49060455	2020/06/03	2021/06/02
MTI-E058	ESG Series Analog Signal Generator	Agilent	E4421B	GB40051240	2020/07/03	2021/07/04
MTI-E062	PXA Signal Analyzer	Agilent	N9030A	MY51350296	2020/06/04	2021/06/03
MTI-E066	MXA Signal Analyzer	Agilent	N9020A	MY50143483	2020/06/04	2021/06/03
MTI-E078	Synthesized Sweeper	Agilent	83752A	3610A01957	2020/06/04	2021/06/03
MTI-E079	DC Power Supply	Agilent	E3632A	MY40027695	2020/06/04	2021/06/03
MTI-E045	Double Ridged Broadband Horn Antenna	schwarzbeck	BBHA 9120D	9120D-2278	2020/06/05	2021/06/04
MTI-E021	EMI Test Receiver	Rohde&schwarz	ESCS30	100210	2020/06/04	2021/06/03
MTI-E022	Pulse Limiter	Schwarzbeck	VSTD 9561-F	00679	2020/06/03	2021/06/02
MTI-E023	Artificial mains network	Schwarzbeck	NSLK 8127	NSLK 8127 #841	2020/06/04	2021/06/03
MTI-E046	Active Loop Antenna	Schwarzbeck	FMZB 1519B	00044	2020/06/05	2021/06/04
MTI-E048	Amplifier	Agilent	8449B	3008A02400	2020/07/03	2021/07/04
MTI-E072	Thermometer Clock Humidity Monitor	-	HTC-1	/	2020/06/07	2021/06/06

Note: the calibration interval of the above test instruments is 12 months and the calibrations are traceable to international system unit (SI).



5. Test Result

5.1. Antenna requirement

5.1.1 Standard Requirement

15.203 requirement: For intentional device, according to 15.203: an intentional radiator shall be designed to ensure that no antenna other than that furnished by the responsible party shall be used with the device

5.1.2 EUT Antenna

The EUT antenna is PCB antenna (1.5dBi). It comply with the standard requirement. In case of replacement of broken antenna the same antenna type must be used.



5.2. Peak Output Power Test

5.2.1 Limit

FCC Part15 Subpart C			
Section	Test Item	Limit	Frequency Range (MHz)
15.247(b)(3)	Peak output power	1 watt or 30dBm	2400-2483.5

5.2.2 Test setup

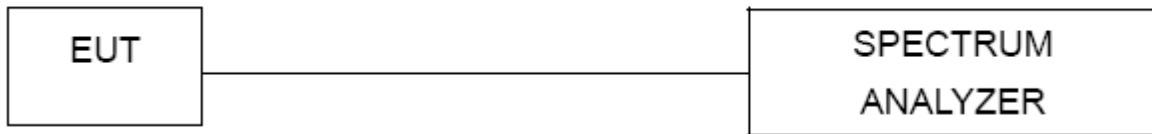

5.2.3 Test Procedure

- (1) The EUT was directly connected to the spectrum analyzer and antenna output port as show in the block diagram above.
- (2) Spectrum Setting:
 RBW=1MHz, VBW=3MHz, Detector=Peak (If 20dB BW ≤1 MHz)
 RBW=3MHz, VBW=8MHz, Detector=Peak (If 20dB BW > 1 MHz)
- (3) The EUT was set to continuously transmitting in the max power during the test.

5.2.4 Test Results

EUT:	Portable Battery-Operated Acoustic Amp	Model Name:	AC-25
Pressure:	1012 hPa	Test Voltage:	DC 11.1V from battery
Test Mode:	TX Mode /CH00, CH19, CH39		

Test Channel	Frequency	Maximum Conducted Output Power(PK)	Limit
	(MHz)	(dBm)	dBm
CH00	2402	4.050	30
CH19	2440	4.730	30
CH39	2480	3.296	30



2402MHz

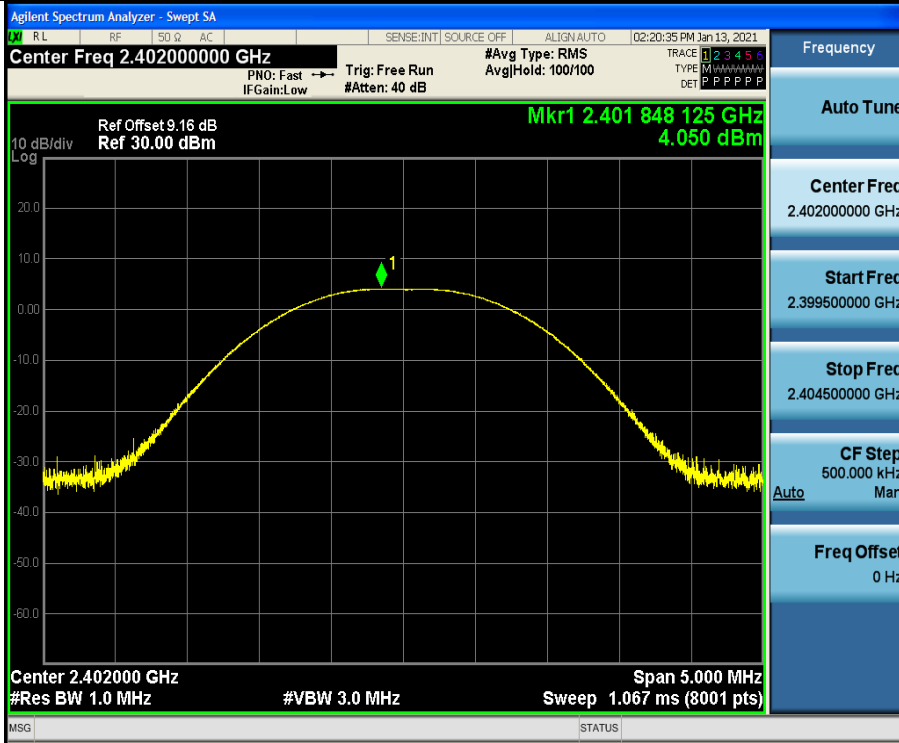

2440MHz

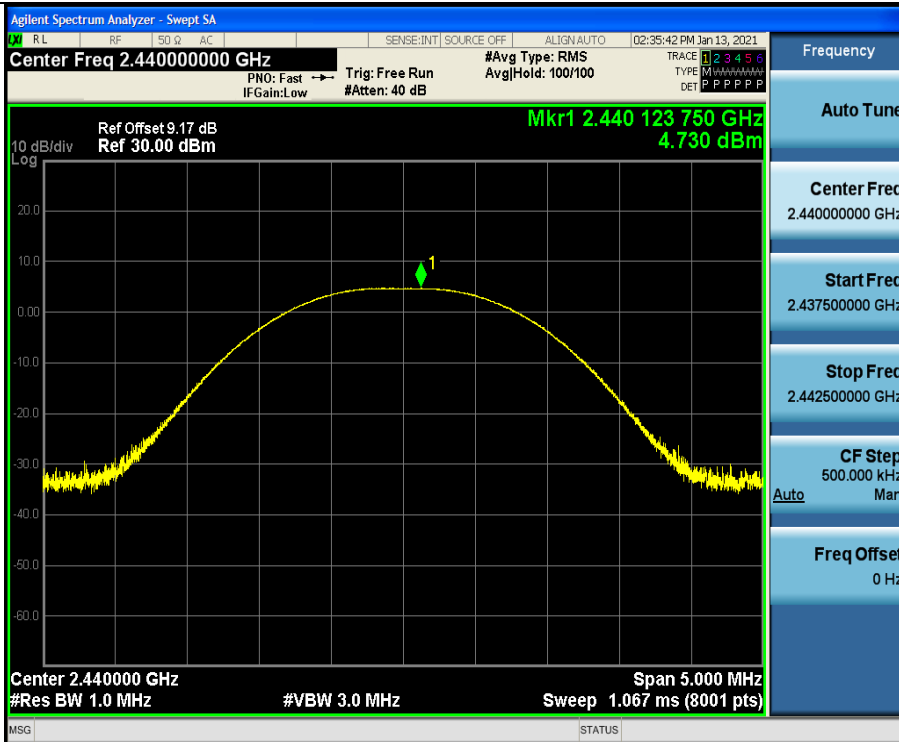



2480MHz

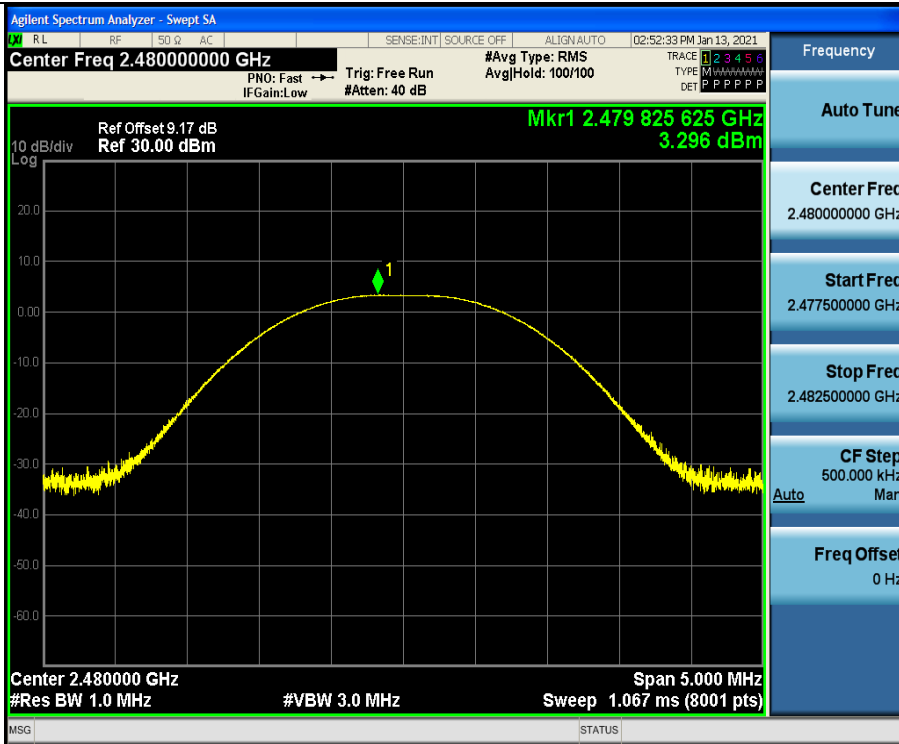



5.3. Conducted emission

5.3.1 Limits

FREQUENCY (MHz)	Class B (dBuV)	
	Quasi-peak	Average
0.15 -0.5	66 - 56 *	56 - 46 *
0.50 -5.0	56.00	46.00
5.0 -30.0	60.00	50.00

Note: *Decreases with the logarithm of the frequency.

5.3.2 Test Setup

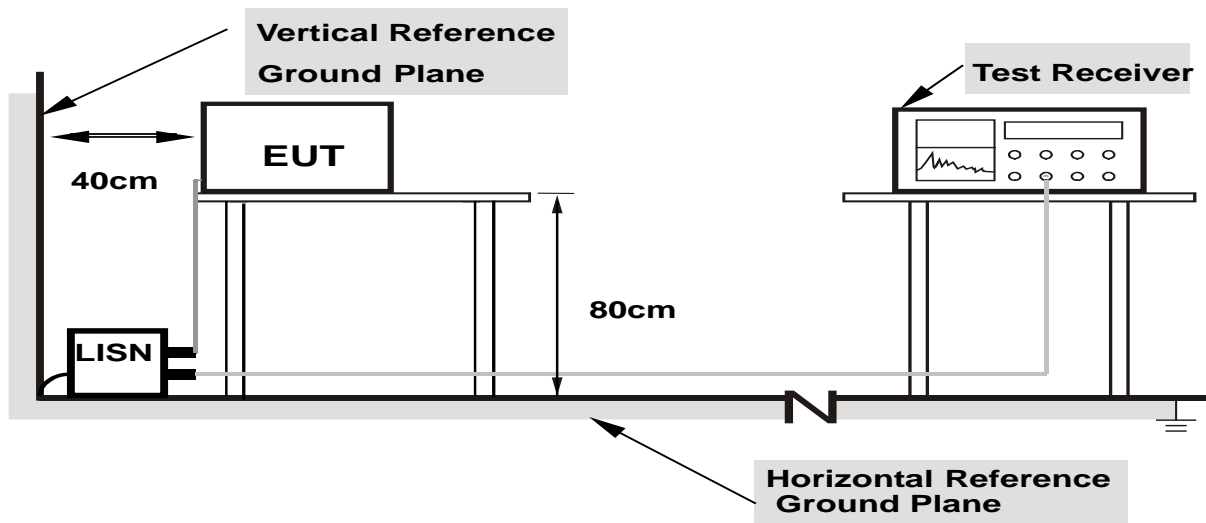

- Note: 1.Support units were connected to second LISN.**
2.Both of LISNs (AMN) are 80 cm from EUT and at least 80 from other units and other metal planes



5.3.3 Test Procedure

a. EUT Operating Conditions

The EUT was configured for testing in a typical fashion (as a customer would normally use it). The EUT has been programmed to continuously transmit during test. This operating condition was tested and used to collect the included data.

b. The following table is the setting of the receiver

Receiver Parameters	Setting
Attenuation	10 dB
Start Frequency	0.15 MHz
Stop Frequency	30 MHz
IF Bandwidth	9 kHz

c. The EUT was placed 0.8 meters from the horizontal ground plane with EUT being connected to the power mains through a line impedance stabilization network (LISN). All other support equipments powered from additional LISN(s). The LISN provide 50 Ohm/ 50uH of coupling impedance for the measuring instrument.

d. Interconnecting cables that hang closer than 40 cm to the ground plane shall be folded back and forth in the center forming a bundle 30 to 40 cm long.

e. I/O cables that are not connected to a peripheral shall be bundled in the center. The end of the cable may be terminated, if required, using the correct terminating impedance. The overall length shall not exceed 1 m.

f. LISN at least 80 cm from nearest part of EUT chassis.

For the actual test configuration, please refer to the related Item – EUT Test Photos.

5.3.4 Test Results

Note:

1. The three modulated high, medium and low channels have been tested. The report only shows the worst mode. The worst mode is GFSK CH00.
2. Emission Level = Reading Level + Factor, Margin = Emission Level - Limit, Factor = LISN modulus + Cable Loss



EUT:	Portable Battery-Operated Acoustic Amp	Model Name:	AC-25
Pressure:	1010hPa	Phase:	L
Test Voltage:	DC 15V from adapter AC 120V/60Hz	Test Mode:	Charging + TX

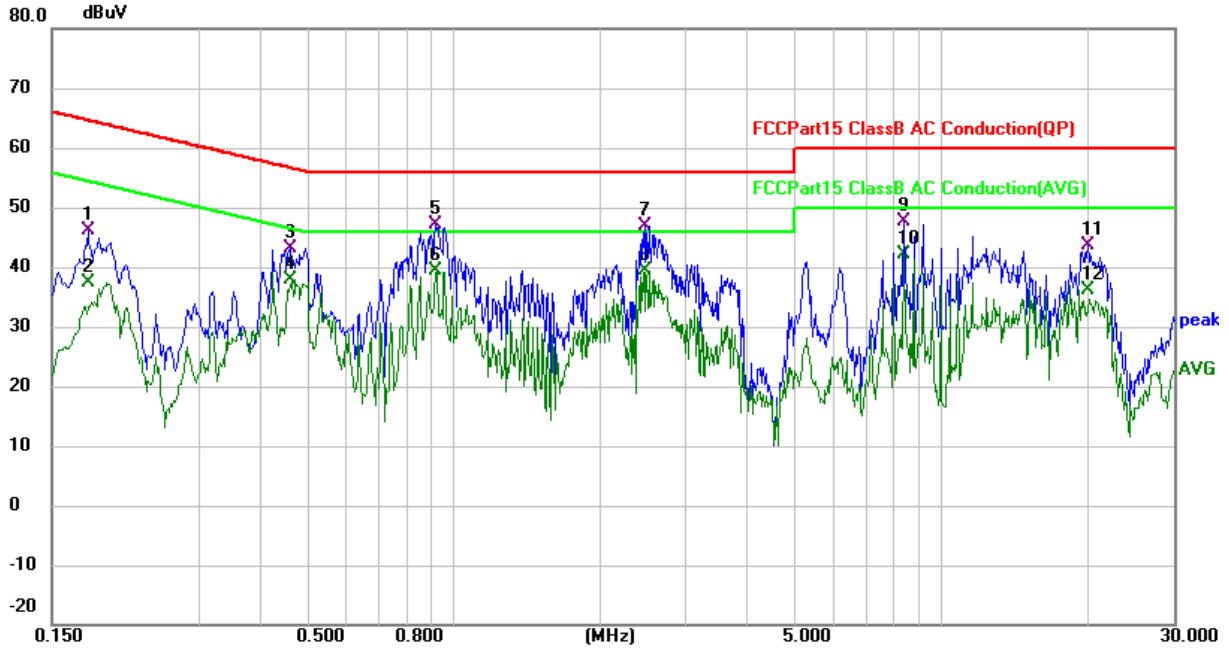

No.	Mk.	Freq. MHz	Reading Level dBuV	Correct Factor dB	Measure- ment dBuV	Limit dBuV	Over dB	Detector
1		0.1779	36.00	10.09	46.09	64.58	-18.49	QP
2		0.1779	27.26	10.09	37.35	54.58	-17.23	AVG
3		0.4620	32.41	10.81	43.22	56.66	-13.44	QP
4		0.4620	27.01	10.81	37.82	46.66	-8.84	AVG
5		0.9220	35.26	11.81	47.07	56.00	-8.93	QP
6		0.9220	27.56	11.81	39.37	46.00	-6.63	AVG
7		2.4860	36.94	10.05	46.99	56.00	-9.01	QP
8	*	2.4860	29.36	10.05	39.41	46.00	-6.59	AVG
9		8.4016	37.17	10.35	47.52	60.00	-12.48	QP
10		8.4016	31.74	10.35	42.09	50.00	-7.91	AVG
11		20.0300	33.31	10.40	43.71	60.00	-16.29	QP
12		20.0300	25.80	10.40	36.20	50.00	-13.80	AVG



EUT:	Portable Battery-Operated Acoustic Amp	Model Name:	AC-25
Pressure:	1010hPa	Phase:	N
Test Voltage:	DC 15V from adapter AC 120V/60Hz	Test Mode:	Charging + TX

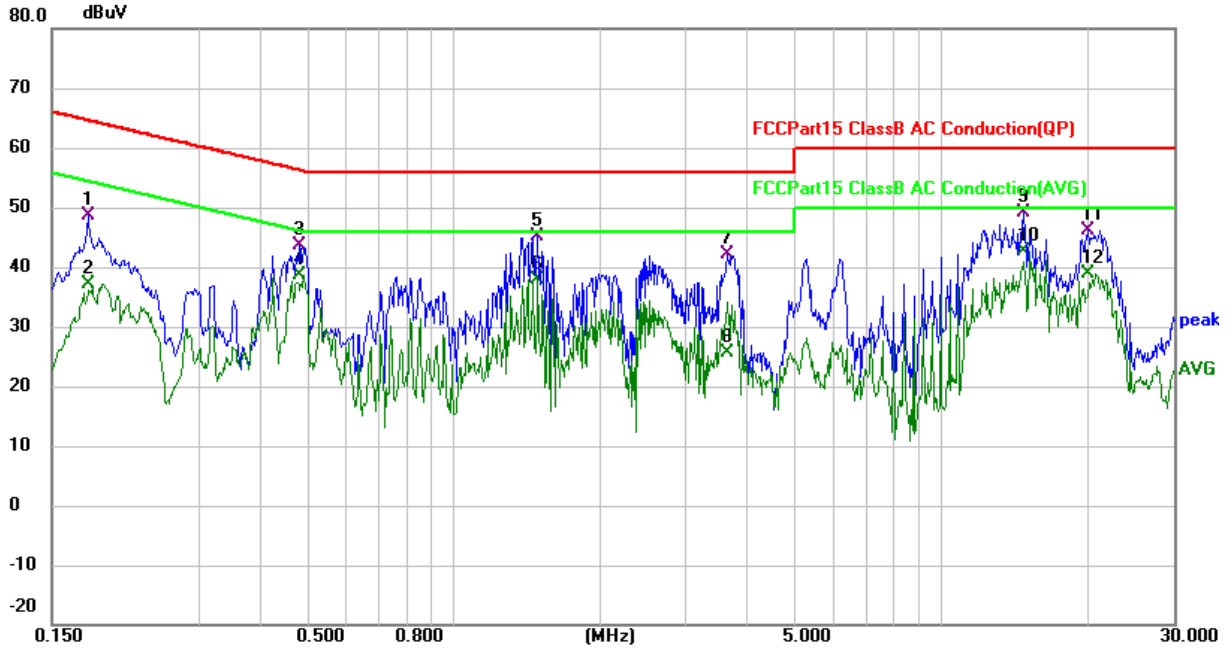

No.	Mk.	Freq. MHz	Reading Level dBuV	Correct Factor dB	Measure- ment dBuV	Limit dBuV	Over dB	Detector
1		0.1779	38.50	10.09	48.59	64.58	-15.99	QP
2		0.1779	27.10	10.09	37.19	54.58	-17.39	AVG
3		0.4858	32.80	10.89	43.69	56.24	-12.55	QP
4		0.4858	27.73	10.89	38.62	46.24	-7.62	AVG
5		1.4900	32.19	12.98	45.17	56.00	-10.83	QP
6		1.4900	24.84	12.98	37.82	46.00	-8.18	AVG
7		3.6579	32.14	10.11	42.25	56.00	-13.75	QP
8		3.6579	15.50	10.11	25.61	46.00	-20.39	AVG
9		14.8100	38.72	10.41	49.13	60.00	-10.87	QP
10	*	14.8100	32.18	10.41	42.59	50.00	-7.41	AVG
11		20.0300	35.81	10.40	46.21	60.00	-13.79	QP
12		20.0300	28.45	10.40	38.85	50.00	-11.15	AVG



EUT:	Portable Battery-Operated Acoustic Amp	Model Name:	AC-25
Pressure:	1010hPa	Phase:	L
Test Voltage:	DC 15V from adapter AC 240V/60Hz	Test Mode:	Charging + TX

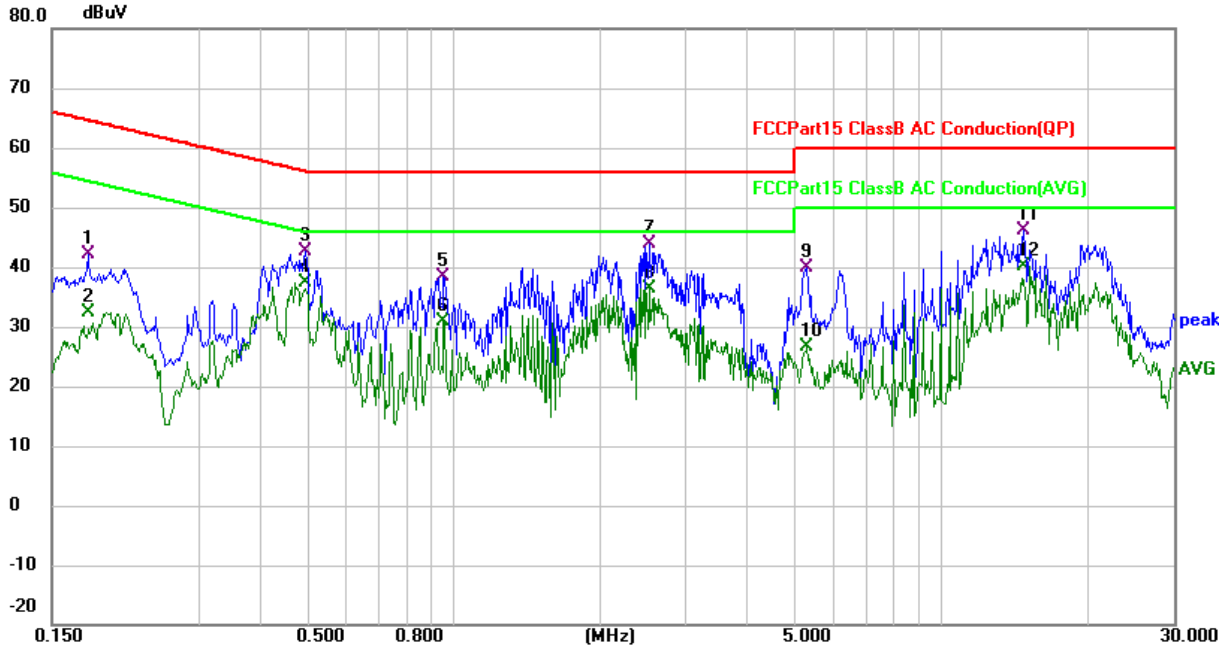

No.	Mk.	Freq. MHz	Reading Level dBuV	Correct Factor dB	Measure- ment dBuV	Limit dBuV	Over dB	Detector
1		0.1779	32.00	10.09	42.09	64.58	-22.49	QP
2		0.1779	22.33	10.09	32.42	54.58	-22.16	AVG
3		0.4979	31.67	10.92	42.59	56.03	-13.44	QP
4	*	0.4979	26.40	10.92	37.32	46.03	-8.71	AVG
5		0.9576	26.52	11.89	38.41	56.00	-17.59	QP
6		0.9576	19.11	11.89	31.00	46.00	-15.00	AVG
7		2.5219	33.86	10.05	43.91	56.00	-12.09	QP
8		2.5219	26.42	10.05	36.47	46.00	-9.53	AVG
9		5.2938	29.72	10.19	39.91	60.00	-20.09	QP
10		5.2938	16.48	10.19	26.67	50.00	-23.33	AVG
11		14.8100	35.72	10.41	46.13	60.00	-13.87	QP
12		14.8100	29.68	10.41	40.09	50.00	-9.91	AVG



EUT:	Portable Battery-Operated Acoustic Amp	Model Name:	AC-25
Pressure:	1010hPa	Phase:	N
Test Voltage:	DC 15V from adapter AC 240V/60Hz	Test Mode:	Charging + TX

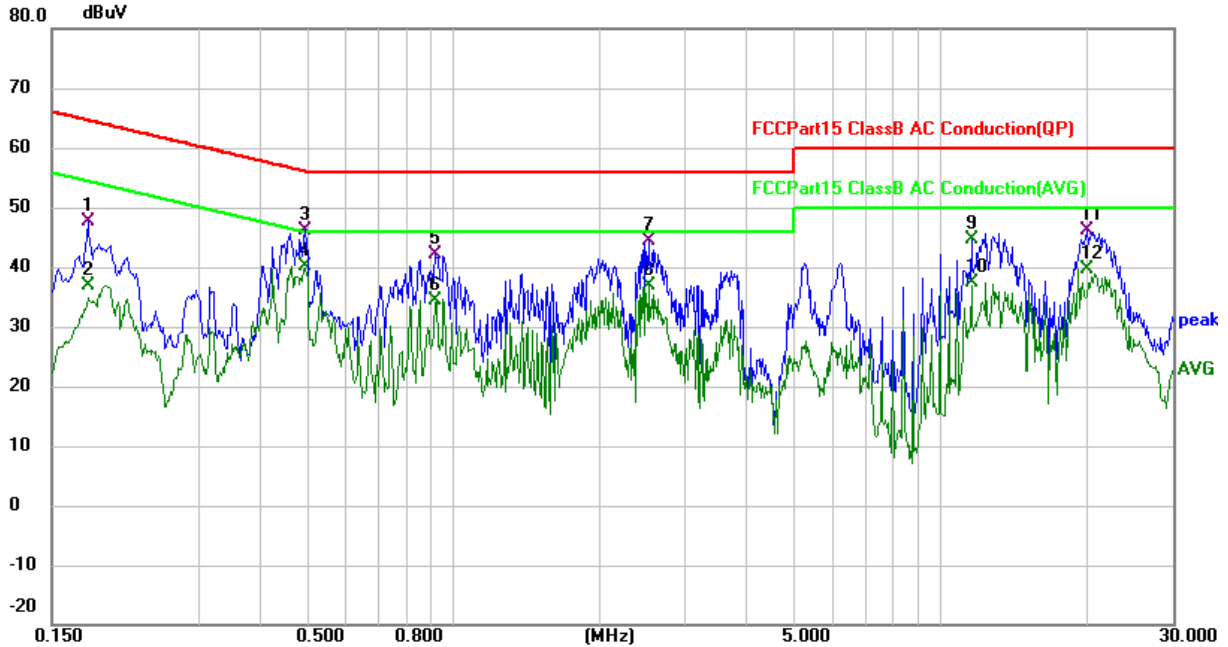

No.	Mk.	Freq. MHz	Reading Level dBuV	Correct Factor dB	Measure- ment dBuV	Limit dBuV	Over dB	Detector
1		0.1779	37.50	10.09	47.59	64.58	-16.99	QP
2		0.1779	26.83	10.09	36.92	54.58	-17.66	AVG
3		0.4979	35.17	10.92	46.09	56.03	-9.94	QP
4		0.4979	29.12	10.92	40.04	46.03	-5.99	AVG
5		0.9220	30.26	11.81	42.07	56.00	-13.93	QP
6		0.9220	22.69	11.81	34.50	46.00	-11.50	AVG
7		2.5219	34.36	10.05	44.41	56.00	-11.59	QP
8		2.5219	26.86	10.05	36.91	46.00	-9.09	AVG
9	*	11.6019	34.12	10.43	44.55	50.00	-5.45	AVG
10		11.6019	26.89	10.43	37.32	50.00	-12.68	AVG
11		20.0300	35.81	10.40	46.21	60.00	-13.79	QP
12		20.0300	29.30	10.40	39.70	50.00	-10.30	AVG



5.4. Radiated spurious emission

5.4.1 Limits

Frequency (MHz)	Field Strength (micorvolts/meter)	Measurement Distance (meters)
0.009~0.490	2400/F(kHz)	300
0.490~1.705	24000/F(kHz)	30
1.705~30.0	30	30
30~88	100	3
88~216	150	3
216~960	200	3
Above 960	500	3

Spectrum Parameter	Setting
Attenuation	Auto
Start Frequency	1000 MHz
Stop Frequency	10th carrier harmonic
RB / VB (emission in restricted band)	1 MHz / 1 MHz for Peak, 1 MHz / 10Hz for Average

Receiver Parameter	Setting
Attenuation	Auto
Start ~ Stop Frequency	9kHz~150kHz / RB 200Hz for QP
Start ~ Stop Frequency	150kHz~30MHz / RB 9kHz for QP
Start ~ Stop Frequency	30MHz~1000MHz / RB 120kHz for QP



5.4.2 Test Setup

Radiated emission test-up frequency below 30MHz

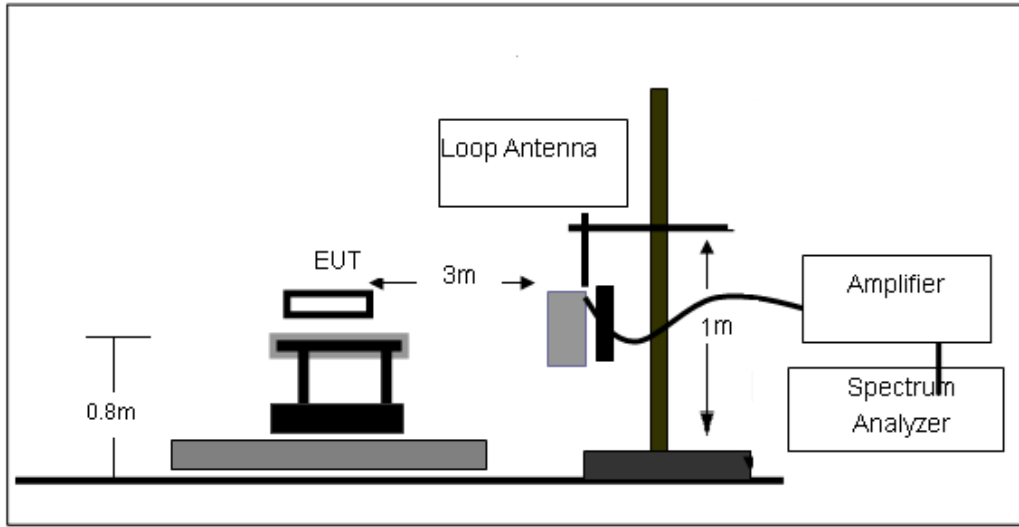

Radiated emission test-up frequency 30MHz~1GHz

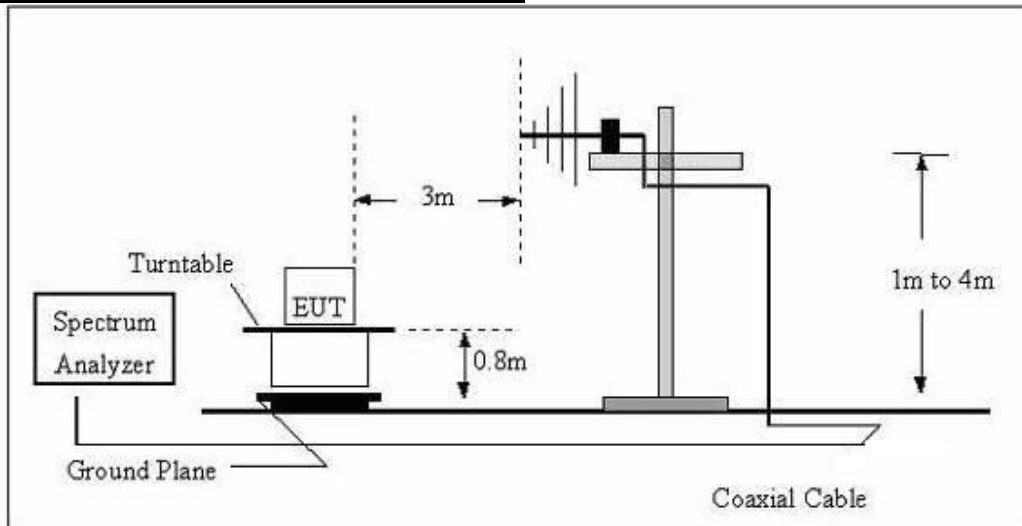

Radiated emission test-up frequency above 1GHz

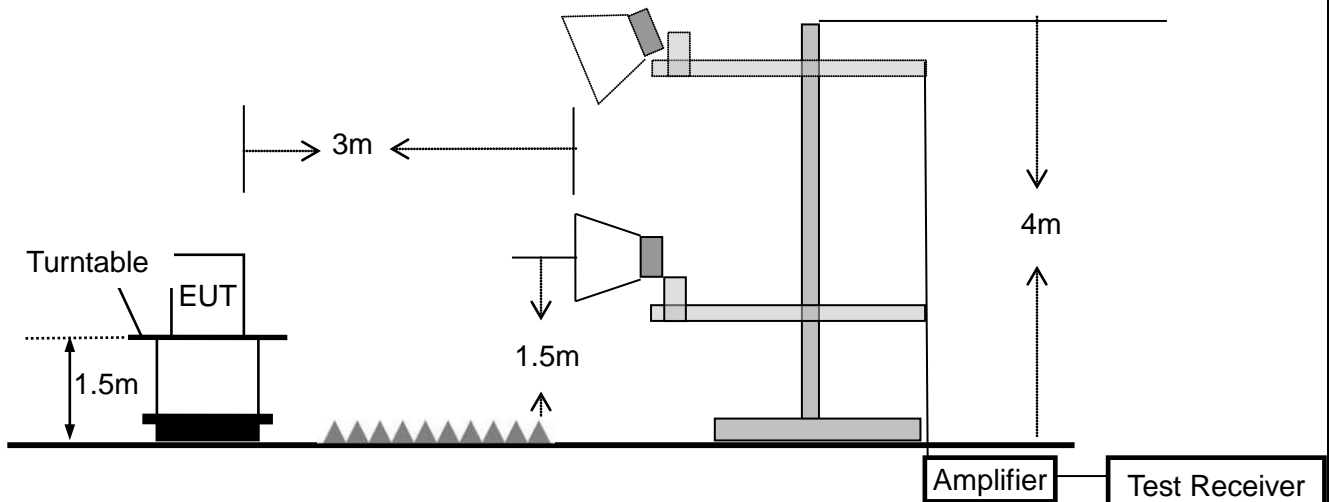



5.4.3 Test Procedure

- a. EUT operating conditions. The EUT tested system was configured as the statements of 3.2 Unless otherwise a special operating condition is specified in the follows during the testing.
- b. The measuring distance of at 3 m shall be used for measurements at frequency up to 1GHz. For frequencies above 1GHz, any suitable measuring distance may be used.
- c. The EUT was placed on the top of a rotating table 0.8 meters above the ground at a 3 meter shield area test site. The table was rotated 360 degrees to determine the position of the highest radiation.
- d. The height of the equipment or of the substitution antenna shall be 0.8 m; the height of the test antenna shall vary between 1 m to 4 m. Both horizontal and vertical polarizations of the antenna are set to make the measurement.
- e. For emission measurements above 1 GHz, the EUT shall be placed at a height of 1.5 m above the floor on a support that is RF transparent for the frequencies of interest. Final measurements for the EUT require a measurement antenna height scan of 1 m to 4 m.
- f. The initial step in collecting conducted emission data is a spectrum analyzer peak detector mode pre-scanning the measurement frequency range. Significant peaks are then marked and then Quasi Peak detector mode re-measured.
- g. If the Peak Mode measured value compliance with and lower than Quasi Peak Mode Limit, the EUT shall be deemed to meet QP Limits and then no additional QP Mode measurement performed.
- h. For the actual test configuration, please refer to the related Item –EUT Test photos.

Note: Both horizontal and vertical antenna polarities were tested. The worst case emissions were reported.

During the radiated emission test, the Spectrum Analyzer was set with the following configurations:

Frequency Band (MHz)	Function	Resolution bandwidth	Video Bandwidth
30 to 1000	QP	120 kHz	300 kHz
Above 1000	Peak	1 MHz	1 MHz
	Average	1 MHz	10 Hz

Note: for the frequency ranges below 30 MHz, a narrower RBW is used for these ranges but the measured value should add a RBW correction factor (RBWCF) where $RBWCF [dB] = 10 \cdot \lg(100 [kHz] / \text{narrower RBW [kHz]})$. , the narrower RBW is 1 kHz and RBWCF is 20 dB for the frequency 9 kHz to 150 kHz, and the narrower RBW is 10 kHz and RBWCF is 10 dB for the frequency 150 kHz to 30 MHz.



5.4.4 Test Results

Below 30MHz

EUT:	Portable Battery-Operated Acoustic Amp	Model Name:	AC-25
Pressure:	1010 hPa	Test Voltage:	DC 15V from adapter AC 120V/60Hz
Test Mode:	Charging + TX	Polarization::	--

Freq.	Reading	Limit	Margin	State
(MHz)	(dBuV/m)	(dBuV/m)	(dB)	P/F
--	--	--	--	Pass
--	--	--	--	Pass

Note:

1. For 9kHz-30MHz, the amplitude of spurious emissions which are attenuated by more than 20dB below the permissible value has no need to be reported.
2. Distance extrapolation factor = $40 \log(\text{specific distance}/\text{test distance})$ (dB);
3. Limit line = specific limits (dBuV) + distance extrapolation factor.



Between 30MHz – 1GHz

EUT:	Portable Battery-Operated Acoustic Amp	Model Name:	AC-25
Pressure:	1010 hPa	Phase:	H
Test Mode:	Charging + TX	Test Voltage:	DC 15V from adapter AC 120V/60Hz

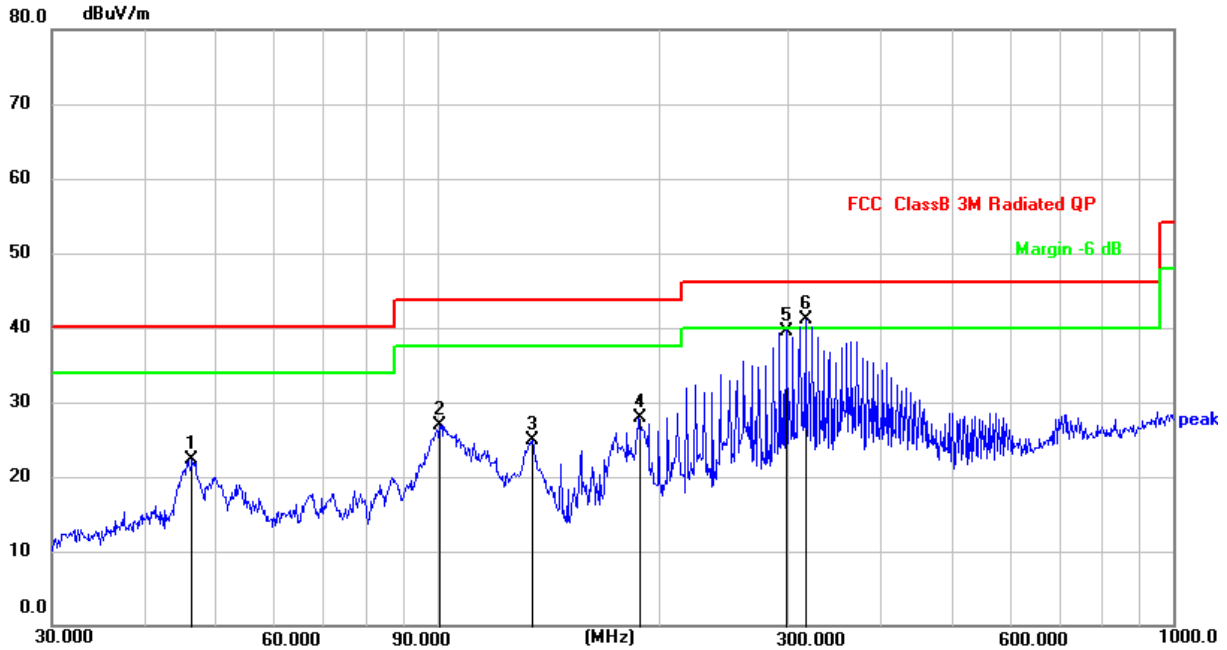

No.	Frequency (MHz)	Reading (dBuV)	Factor (dB/m)	Level (dBuV/m)	Limit (dBuV/m)	Margin (dB)	Detector
1	46.5030	34.32	-11.94	22.38	40.00	-17.62	QP
2	100.9339	39.46	-12.55	26.91	43.50	-16.59	QP
3	134.5592	39.99	-15.06	24.93	43.50	-18.57	QP
4	187.7530	40.50	-12.52	27.98	43.50	-15.52	QP
5	298.2681	48.34	-8.74	39.60	46.00	-6.40	QP
6 *	316.5890	49.81	-8.66	41.15	46.00	-4.85	QP



EUT:	Portable Battery-Operated Acoustic Amp	Model Name:	AC-25
Pressure:	1010 hPa	Phase:	V
Test Mode:	Charging + TX	Test Voltage:	DC 15V from adapter AC 120V/60Hz

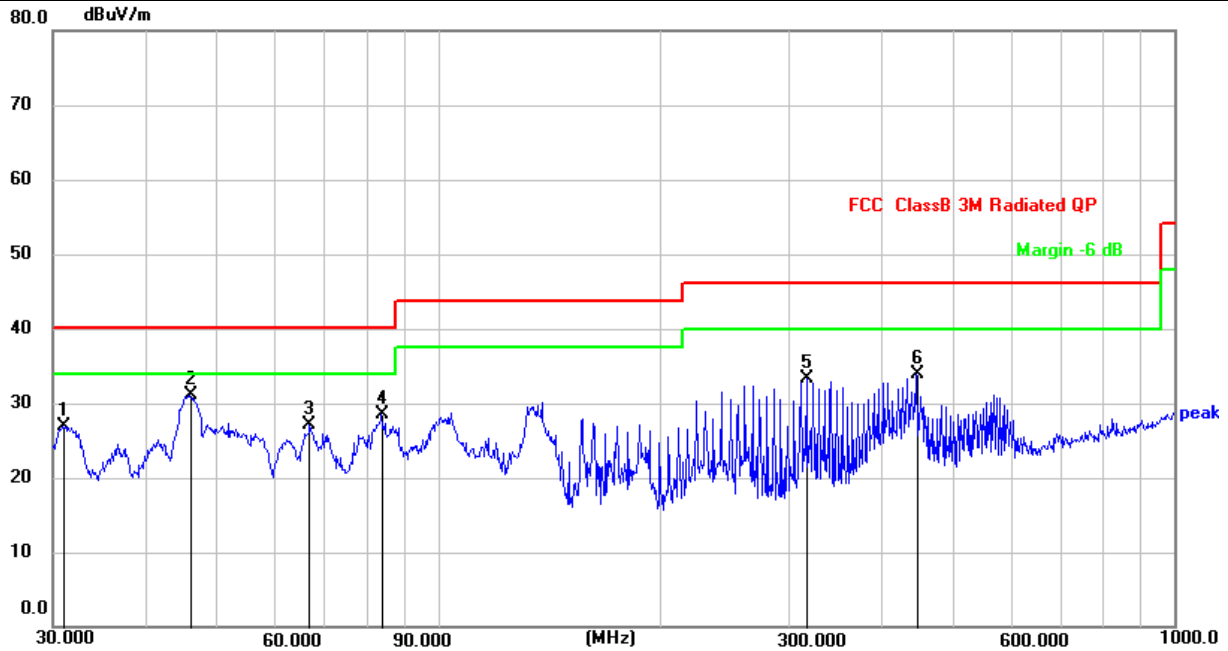

No.	Frequency (MHz)	Reading (dBuV)	Factor (dB/m)	Level (dBuV/m)	Limit (dBuV/m)	Margin (dB)	Detector
1	30.9619	41.69	-14.75	26.94	40.00	-13.06	QP
2 *	46.0164	43.13	-11.97	31.16	40.00	-8.84	QP
3	66.9669	41.82	-14.76	27.06	40.00	-12.94	QP
4	83.8156	43.70	-15.28	28.42	40.00	-11.58	QP
5	316.5890	42.05	-8.66	33.39	46.00	-12.61	QP
6	446.4141	40.20	-6.38	33.82	46.00	-12.18	QP

Note:

1. Emission Level = Meter Reading + Factor, Margin= Emission Level- Limit, Factor = Antenna Factor + Cable Loss – Pre-amplifier.
2. The three modulated high, medium and low channels have been tested. The report only shows the worst mode. The worst mode is CH19.



1GHz-25GHz

Frequency (MHz)	Read Level (dBμV)	Cable loss (dB)	Antenna Factor dB/m	Preamp Factor (dB)	Emission Level (dBμV/m)	Limits (dBμV/m)	Margin (dB)	Remark	Comment
Low Channel (2402 MHz)-Above 1G									
4804.338	61.50	4.36	32.92	45.53	53.25	74.00	-20.75	Pk	Vertical
4804.338	41.55	4.36	32.92	45.53	33.30	54.00	-20.70	AV	Vertical
7206.107	60.81	5.02	37.63	45.56	57.90	74.00	-16.10	Pk	Vertical
7206.107	42.00	5.02	37.63	45.56	39.09	54.00	-14.91	AV	Vertical
4804.169	62.79	4.36	32.92	45.53	54.54	74.00	-19.46	Pk	Horizontal
4804.169	43.37	4.36	32.92	45.53	35.12	54.00	-18.88	AV	Horizontal
7206.214	62.08	5.02	37.63	45.56	59.17	74.00	-14.83	Pk	Horizontal
7206.214	41.65	5.02	37.63	45.56	38.74	54.00	-15.26	AV	Horizontal
Mid Channel (2440 MHz)-Above 1G									
4880.473	62.86	4.41	33.01	45.76	54.52	74.00	-19.48	Pk	Vertical
4880.473	43.79	4.41	33.01	45.76	35.45	54.00	-18.55	AV	Vertical
7320.265	66.25	5.02	37.68	45.59	63.36	74.00	-10.64	Pk	Vertical
7320.265	41.27	5.02	37.68	45.59	38.38	54.00	-15.62	AV	Vertical
4880.366	63.74	4.41	33.01	45.76	55.40	74.00	-18.60	Pk	Horizontal
4880.366	40.80	4.41	33.01	45.76	32.46	54.00	-21.54	AV	Horizontal
7320.234	61.19	5.02	37.68	45.59	58.30	74.00	-15.70	Pk	Horizontal
7320.234	43.55	5.02	37.68	45.59	40.66	54.00	-13.34	AV	Horizontal
High Channel (2480 MHz)- Above 1G									
4960.482	64.45	4.50	33.26	46.07	56.14	74.00	-17.86	Pk	Vertical
4960.482	41.70	4.50	33.26	46.07	33.39	54.00	-20.61	AV	Vertical
7440.131	64.71	5.02	37.78	45.77	61.74	74.00	-12.26	Pk	Vertical
7440.131	48.78	5.02	37.78	45.77	45.81	54.00	-8.19	AV	Vertical
4960.326	62.83	4.50	33.26	46.07	54.52	74.00	-19.48	Pk	Horizontal
4960.326	45.05	4.50	33.26	46.07	36.74	54.00	-17.26	AV	Horizontal
7440.199	64.30	5.02	37.78	45.77	61.33	74.00	-12.67	Pk	Horizontal
7440.199	44.90	5.02	37.78	45.77	41.93	54.00	-12.07	AV	Horizontal

Note:

1. All Readings are Peak Value (VBW=3MHz) and AV Value (VBW=10Hz).
2. Emission Level= Antenna Factor + Cable Loss + Read Level - Preamp Factor
3. All the modulation modes have been tested, and the worst results are reflected in the report.



5.4.4.1 Band edge-radiated

Frequency	Meter Reading	Cable Loss	Antenna Factor	Preamp Factor	Emission Level	Limits	Margin	Detector	Comment
(MHz)	(dB μ V)	(dB)	dB/m	(dB)	(dB μ V/m)	(dB μ V/m)	(dB)	Type	
GFSK									
2310.00	63.67	2.40	27.70	40.40	53.37	74	-20.63	Pk	Horizontal
2310.00	42.27	2.40	27.70	40.40	31.97	54	-22.03	AV	Horizontal
2310.00	62.08	2.40	27.70	40.40	51.78	74	-22.22	Pk	Vertical
2310.00	42.88	2.40	27.70	40.40	32.58	54	-21.42	AV	Vertical
2390.00	64.60	2.44	28.30	40.10	55.24	74	-18.76	Pk	Vertical
2390.00	43.78	2.44	28.30	40.10	34.42	54	-19.58	AV	Vertical
2390.00	63.55	2.44	28.30	40.10	54.19	74	-19.81	Pk	Horizontal
2390.00	42.39	2.44	28.30	40.10	33.03	54	-20.97	AV	Horizontal
2483.50	63.29	2.48	28.70	39.80	54.67	74	-19.33	Pk	Vertical
2483.50	43.93	2.48	28.70	39.80	35.31	54	-18.69	AV	Vertical
2483.50	65.03	2.48	28.70	39.80	56.41	74	-17.59	Pk	Horizontal
2483.50	43.14	2.48	28.70	39.80	34.52	54	-19.48	AV	Horizontal



5.4.4.2 Spurious Emission in Restricted Band 3260MHz-18000MHz

All the modulation modes have been tested, and the worst result was report as below:

Frequency	Reading Level	Cable Loss	Antenna Factor	Preamp Factor	Emission Level	Limits	Margin	Detector	Comment
(MHz)	(dBμV)	(dB)	dB/m	(dB)	(dBμV/m)	(dBμV/m)	(dB)	Type	
3260	60.82	3.27	30.02	38.05	56.06	74	-17.94	Pk	Vertical
3260	40.73	3.27	30.02	38.05	35.97	54	-18.03	AV	Vertical
3260	63.97	3.27	30.02	38.05	59.21	74	-14.79	Pk	Horizontal
3260	42.68	3.27	30.02	38.05	37.92	54	-16.08	AV	Horizontal
3332	64.01	3.31	30.00	37.91	59.41	74	-14.59	Pk	Vertical
3332	42.54	3.31	30.00	37.91	37.94	54	-16.06	AV	Vertical
3332	64.04	3.31	30.00	37.91	59.44	74	-14.56	Pk	Horizontal
3332	41.74	3.31	30.00	37.91	37.14	54	-16.86	AV	Horizontal
17797	43.61	8.63	44.23	39.60	56.87	74	-17.13	Pk	Vertical
17797	30.99	8.63	44.23	39.60	44.25	54	-9.75	AV	Vertical
17788	43.11	8.63	44.23	39.60	56.37	74	-17.63	Pk	Horizontal
17788	30.52	8.63	44.23	39.60	43.78	54	-10.22	AV	Horizontal



5.5 Power spectral density test

5.5.1 Limit

FCC Part15 (15.247) , Subpart C			
Section	Test Item	Limit	Frequency Range (MHz)
15.247	Power Spectral Density	8 dBm (in any 3kHz)	2400-2483.5

5.5.2 Test Procedure

1. Set analyzer center frequency to DTS channel center frequency.
2. Set the span to 1.5 times the DTS channel bandwidth.
3. Set the RBW \geq 3 kHz.
4. Set the VBW \geq 3 x RBW.
5. Detector = peak.
6. Sweep time = auto couple.
7. Trace mode = max hold.
8. Allow trace to fully stabilize.
9. Use the peak marker function to determine the maximum amplitude level.
10. If measured value exceeds limit, reduce RBW (no less than 3 kHz) and repeat.

5.5.3 Test Setup

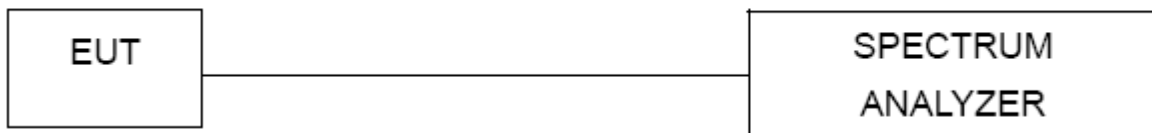



5.5.4 Test Results

EUT:	Portable Battery-Operated Acoustic Amp	Model Name:	AC-25
Pressure:	1015 hPa	Test Voltage:	DC 11.1V from battery
Test Mode:	TX Mode /CH00, CH19, CH39		

Frequency	Power Density (dBm/3kHz)	Limit (dBm/3kHz)	Result
2402 MHz	-6.516	8	PASS
2440 MHz	-5.787	8	PASS
2480 MHz	-7.238	8	PASS

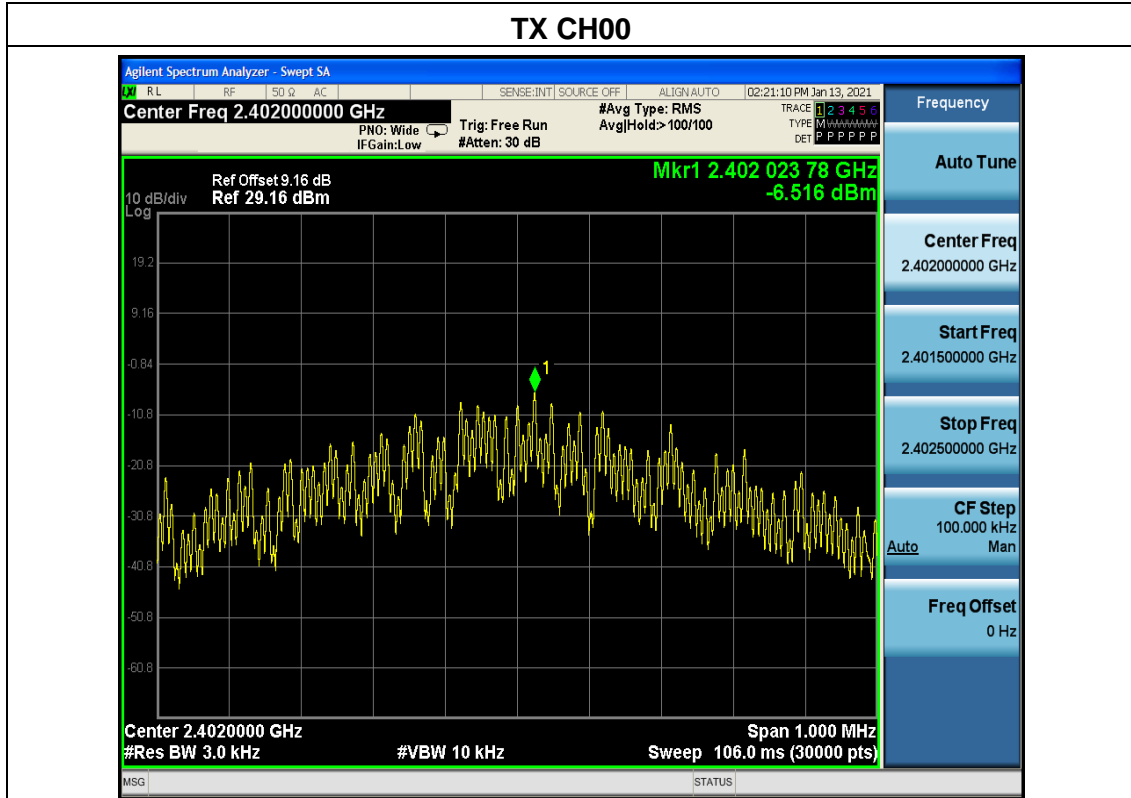



TX CH19

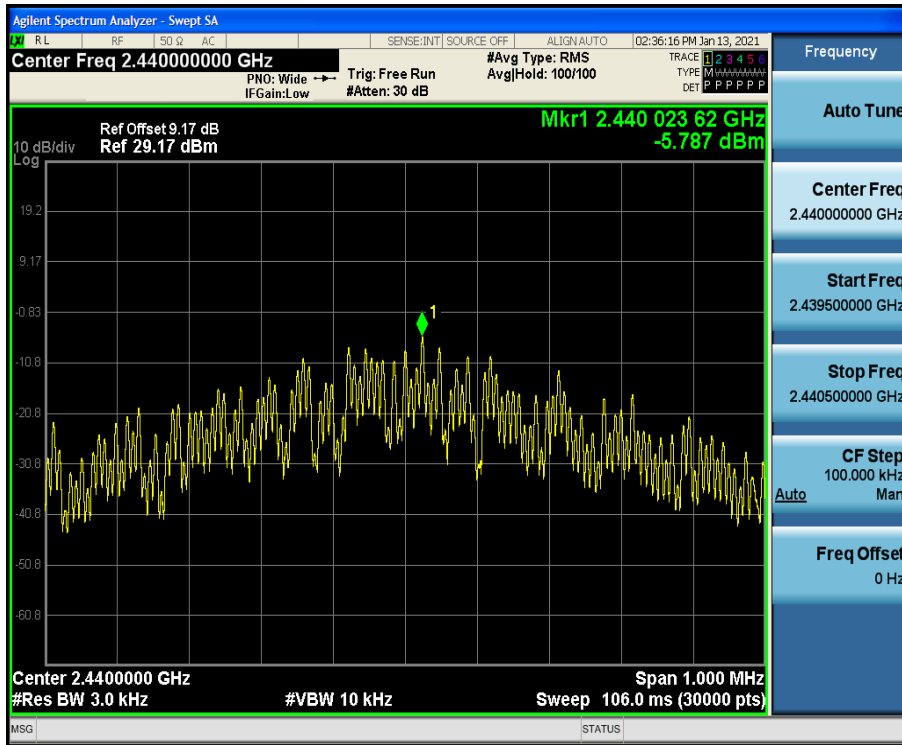

TX CH39

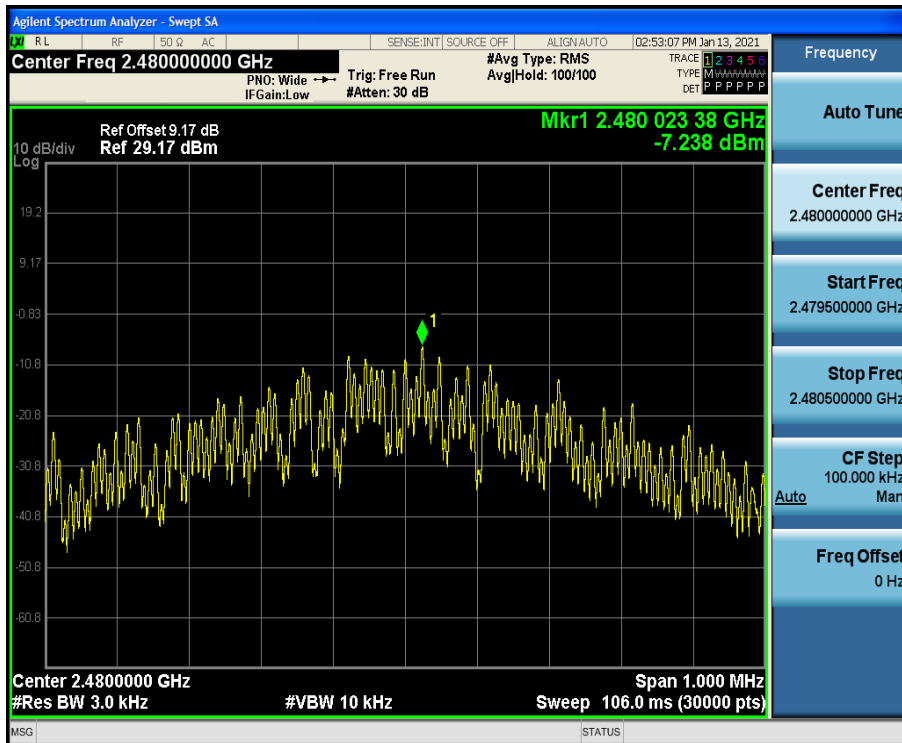



5.6 6dB bandwidth

5.6.1 Limit

FCC Part15 (15.247) , Subpart C			
Section	Test Item	Limit	Frequency Range (MHz)
15.247(a)(2)	Bandwidth	$\geq 500\text{kHz}$ (6dB bandwidth)	2400-2483.5

5.6.2 Test Procedure

1. Set RBW= 100 kHz.
2. Set the video bandwidth (VBW) $\geq 3 \times$ RBW.
3. Detector = Peak.
4. Trace mode = max hold.
5. Sweep = auto couple.
6. Allow the trace to stabilize.
7. Measure the maximum width of the emission that is constrained by the frequencies associated with the two outermost amplitude points (upper and lower) that are attenuated by 6 dB relative to the maximum level measured in the fundamental emission.

5.6.3 Test Setup

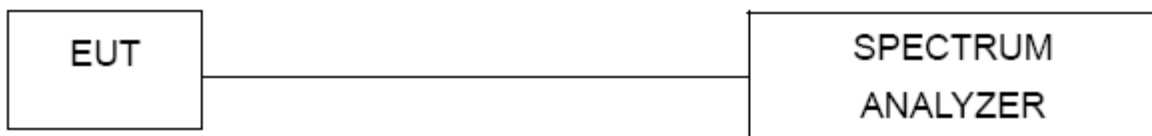

5.6.4 Test Result



EUT:	Portable Battery-Operated Acoustic Amp	Model Name:	AC-25
Pressure:	1012 hPa	Test Voltage:	DC 11.1V from battery
Test Mode:	TX Mode /CH00, CH19, CH39		

Channel	Frequency (MHz)	6dB bandwidth (kHz)	Limit (kHz)	Result
Low	2402	754.2	500	Pass
Middle	2440	746.6	500	Pass
High	2480	756.3	500	Pass

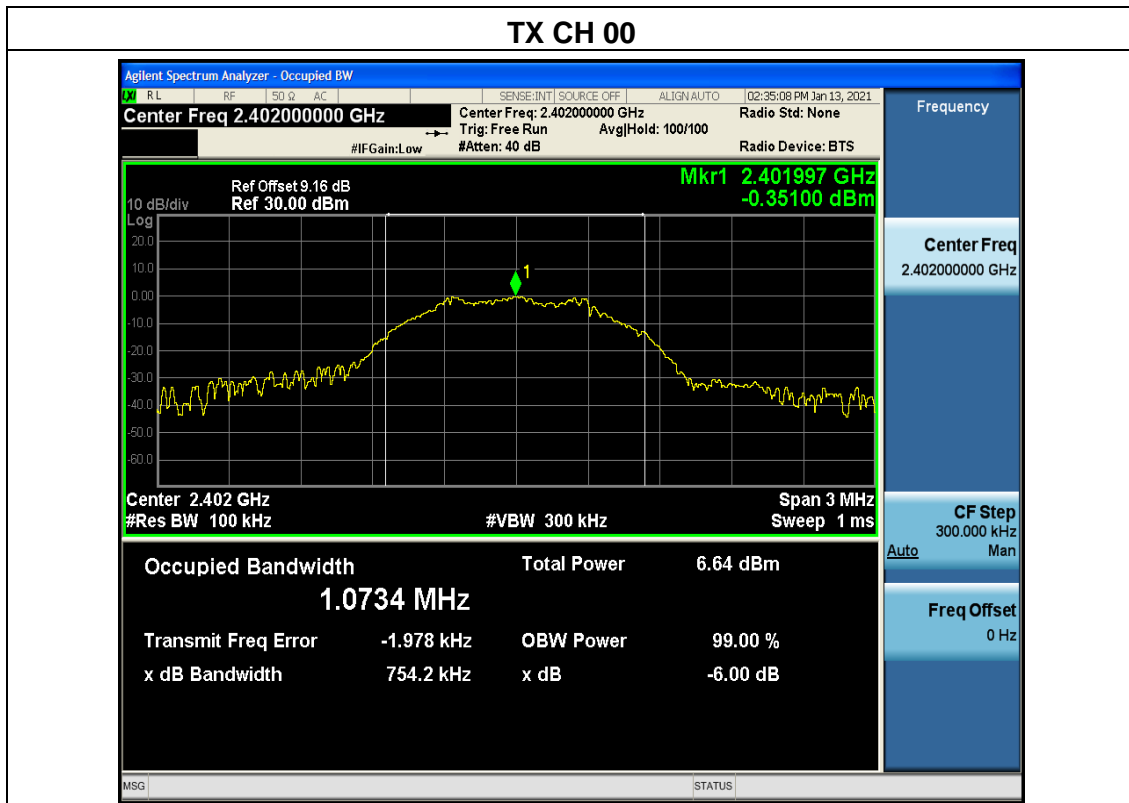



TX CH 19



TX CH 39

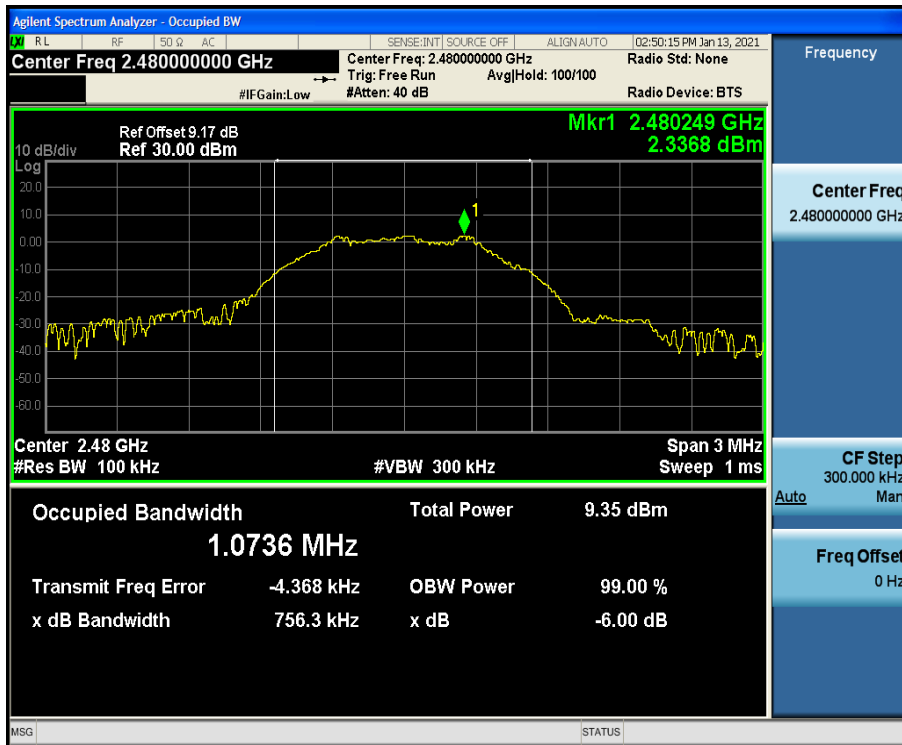



5.7 Duty Cycle

5.7.1 Conformance Limit

No limit requirement.

5.7.2 Measuring Instruments

The Measuring equipment is listed in the section 4 of this test report.

5.7.3 Test Setup



5.7.4 Test Procedure

The zero-span mode on a spectrum analyzer or EMI receiver if the response time and spacing between bins on the sweep are sufficient to permit accurate measurements of the on and off times of the transmitted signal. Set the center frequency of the instrument to the center frequency of the transmission. Set $RBW \geq OBW$ if possible; otherwise, set RBW to the largest available value. Set $VBW \geq RBW$. Set detector = peak or average. The zero-span measurement method shall not be used unless both RBW and VBW are $> 50/T$ and the number of sweep points across duration T exceeds 100. (For example, if VBW and/or RBW are limited to 3 MHz, then the zero-span method of measuring duty cycle shall not be used if $T \leq 16.7$ microseconds.)

The transmitter output is connected to the Spectrum Analyzer. We tested according to the zero-span measurement method, 6.0(b) in KDB 558074 D01 DTS Meas Guidance v05r02.

The largest available value of RBW is 8 MHz and VBW is 50 MHz. The zero-span method of measuring duty cycle shall not be used if $T \leq 6.25$ microseconds. ($50/6.25 = 8$)

The zero-span method was used because all measured T data are > 6.25 microseconds and both RBW and VBW are $> 50/T$.

The RF output of EUT was connected to the spectrum analyzer by RF cable and attenuator.

The path loss was compensated to the results for each measurement.

Set to the maximum power setting and enable the EUT transmit continuously.

The EUT was operating in controlled its channel.

Use the following spectrum analyzer settings:

Span = Zero Span

RBW = 8MHz (the largest available value)

VBW = 8MHz (\geq RBW)

Number of points in Sweep >100

Detector function = peak

Trace = Clear write

Measure Total and Ton

Calculate Duty Cycle = $Ton / Total$



5.7.5 Test Results

EUT:	Portable Battery-Operated Acoustic Amp	Model Name:	AC-25
Pressure:	1012 hPa	Test Voltage:	DC 11.1V from battery
Test Mode:	TX Mode /CH00, CH19, CH39		

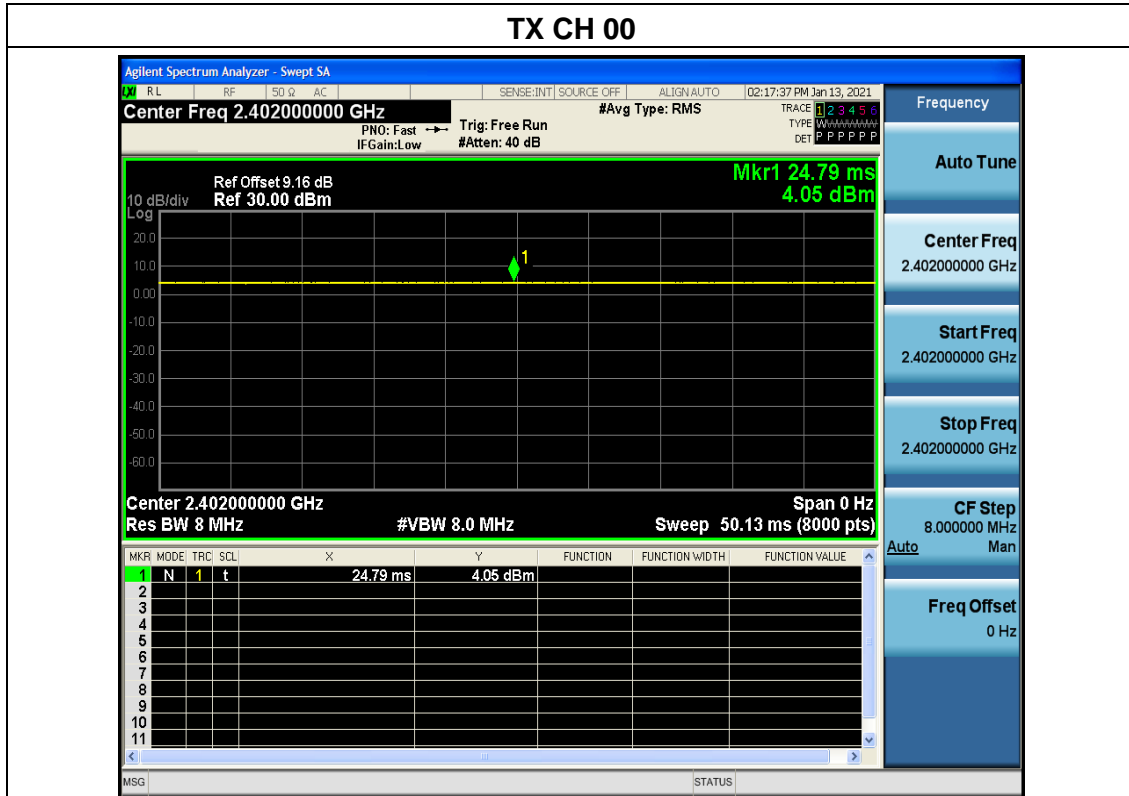



TX CH 19

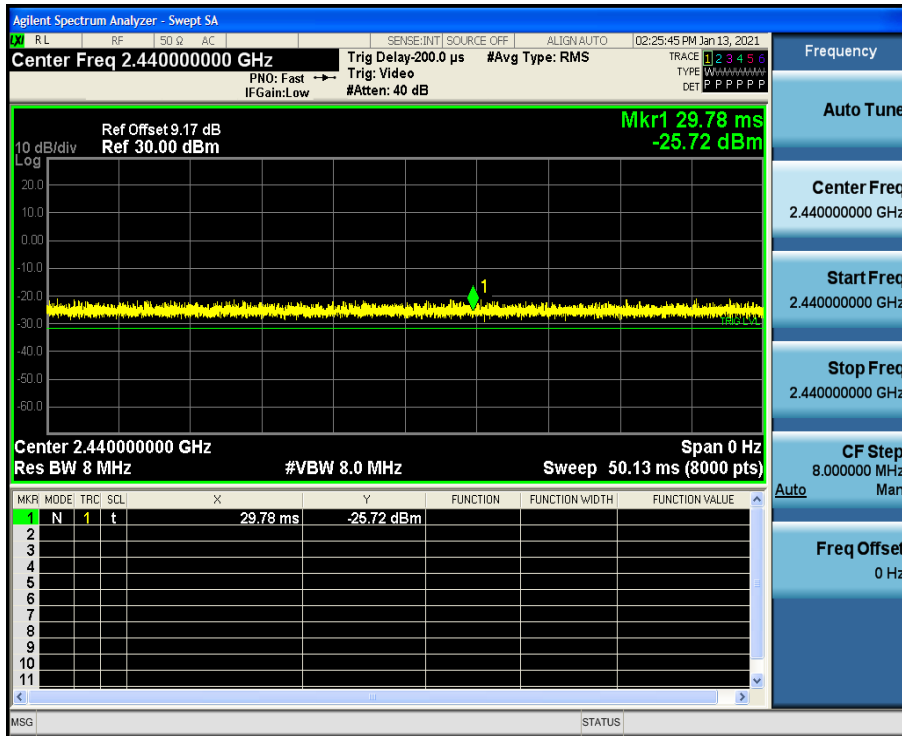

TX CH 39

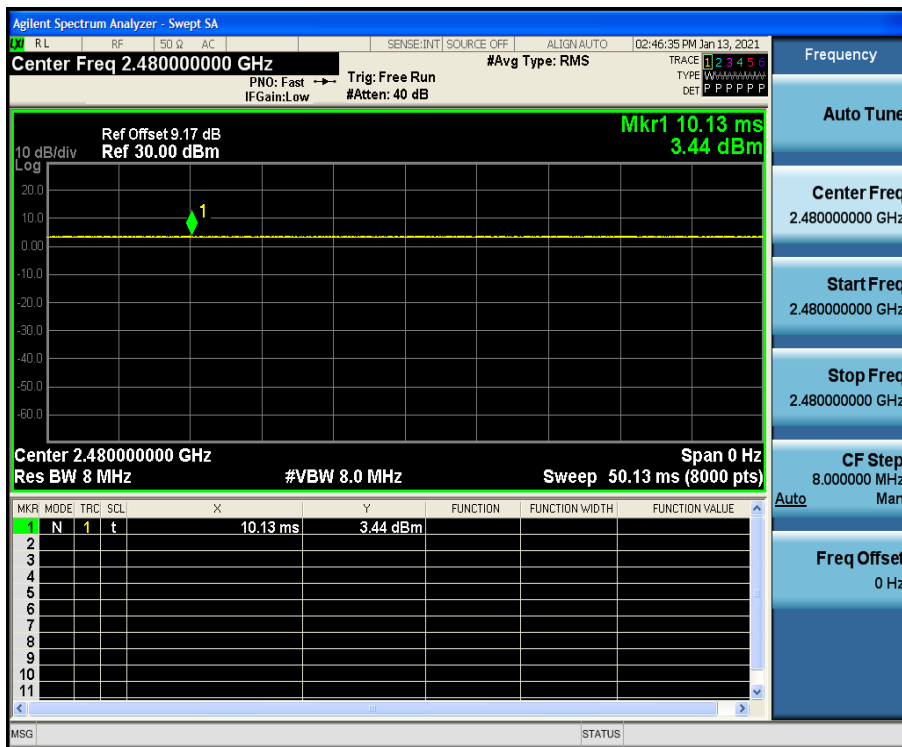



5.8 Conducted band edge

5.8.1 Limits

In any 100 kHz bandwidth outside the frequency band in which the spread spectrum or digitally modulated intentional radiator is operating, the radio frequency power that is produced by the intentional radiator shall be at least 20 dB below that in the 100 kHz bandwidth within the band that contains the highest level of the desired power, based on either an RF conducted or a radiated measurement, provided the transmitter demonstrates compliance with the peak conducted power limits. If the transmitter complies with the conducted power limits based on the use of RMS averaging over a time interval, as permitted under paragraph (b)(3) of this section, the attenuation required under this paragraph shall be 30 dB instead of 20 dB. Attenuation below the general limits specified in §15.209(a) is not required. In addition, radiated emissions which fall in the restricted bands, as defined in §15.205(a), must also comply with the radiated emission limits specified in §15.209(a) (see §15.205(c)).

5.8.2 Test Setup



5.8.3 Test Procedure

- a) Check the calibration of the measuring instrument using either an internal calibrator or a known signal from an external generator.
- b) Position the EUT without connection to measurement instrument. Turn on the EUT and connect its antenna terminal to measurement instrument via a low loss cable. Then set it to any one measured frequency within its operating range, and make sure the instrument is operated in its linear range.
- c) Set RBW to 100 kHz and VBW of spectrum analyzer to 300 kHz with a convenient frequency span including 100 kHz bandwidth from band edge.
- d) Measure the highest amplitude appearing on spectral display and set it as a reference level. Plot the graph with marking the highest point and edge frequency.
- e) Repeat above procedures until all measured frequencies were complete.

5.8.4 Test Result



EUT:	Portable Battery-Operated Acoustic Amp	Model Name:	AC-25
Pressure:	1012 hPa	Test Voltage:	DC 11.1V from battery
Test Mode:	TX Mode /CH00, CH39		

BLE: Band Edge, Left Side

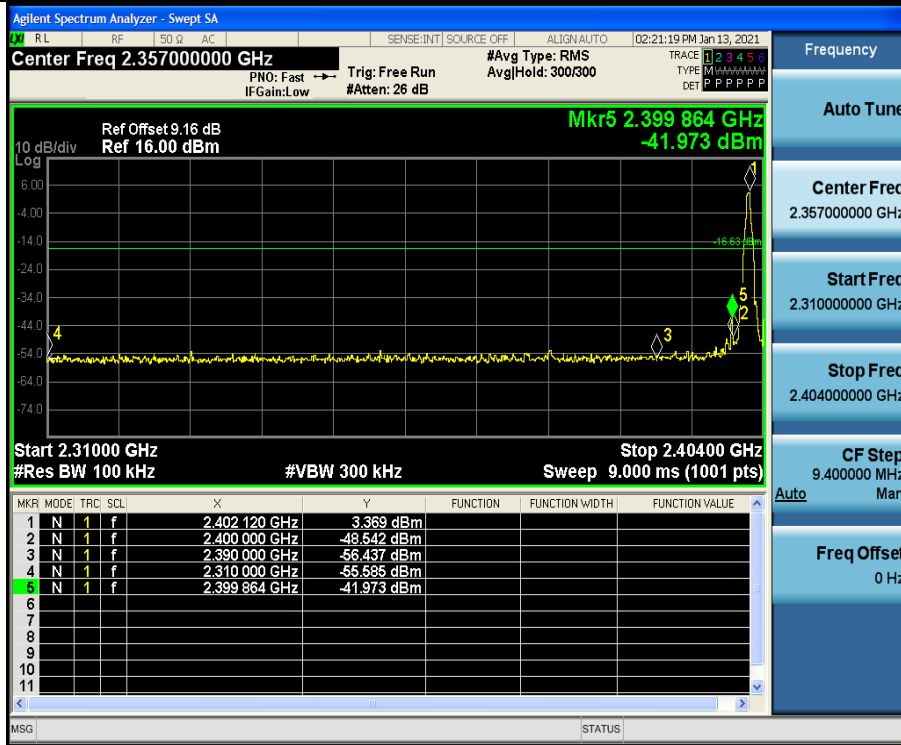

BLE: Band Edge, Right Side

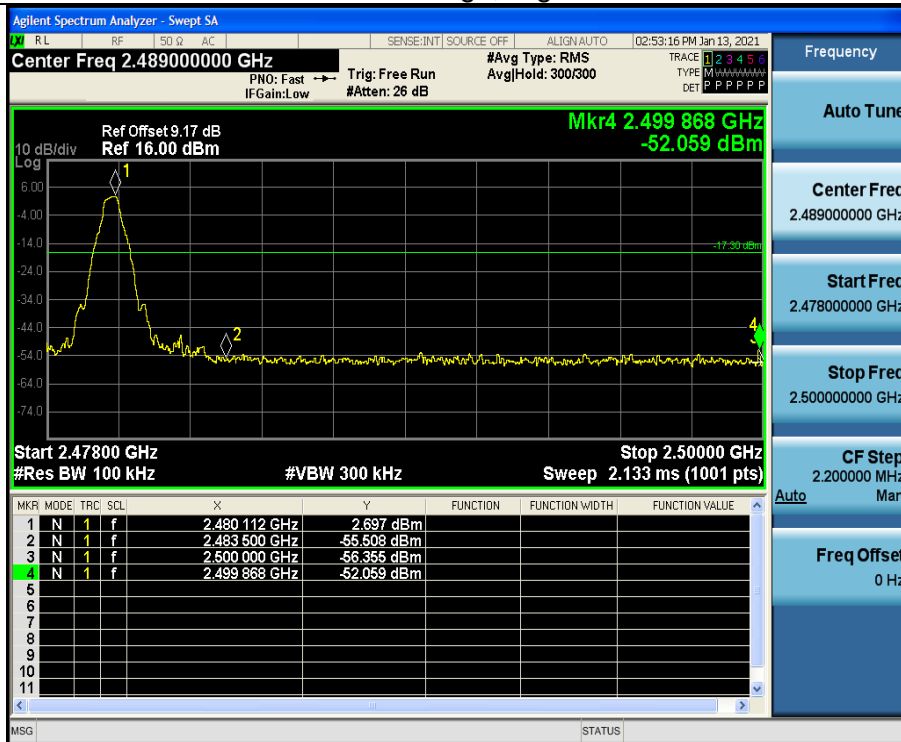



5.9 Spurious RF Conducted Emissions

5.9.1 Conformance Limit

Below -20dB of the highest emission level in operating band.

5.9.2 Measuring Instruments

The Measuring equipment is listed in the section 6.3 of this test report.

5.9.3 Test Setup

Please refer to Section 6.1 of this test report.

5.9.4 Test Procedure

The Spurious RF conducted emissions compliance of RF radiated emission should be measured by following the guidance in ANSI C63.10-2013 with respect to maximizing the emission by rotating the EUT, measuring the emission while the EUT is situated in three orthogonal planes (if appropriate), adjusting the measurement antenna height and polarization etc. Set RBW=100kHz and VBW= 300kHz to measure the peak field strength, and measure frequency range from 9kHz to 26.5GHz.

5.9.5 Test Results

Note: The measurement frequency range is from 9kHz to the 10th harmonic of the fundamental frequency. The lowest, middle and highest channels are tested to verify the spurious emissions and band edge measurement data.

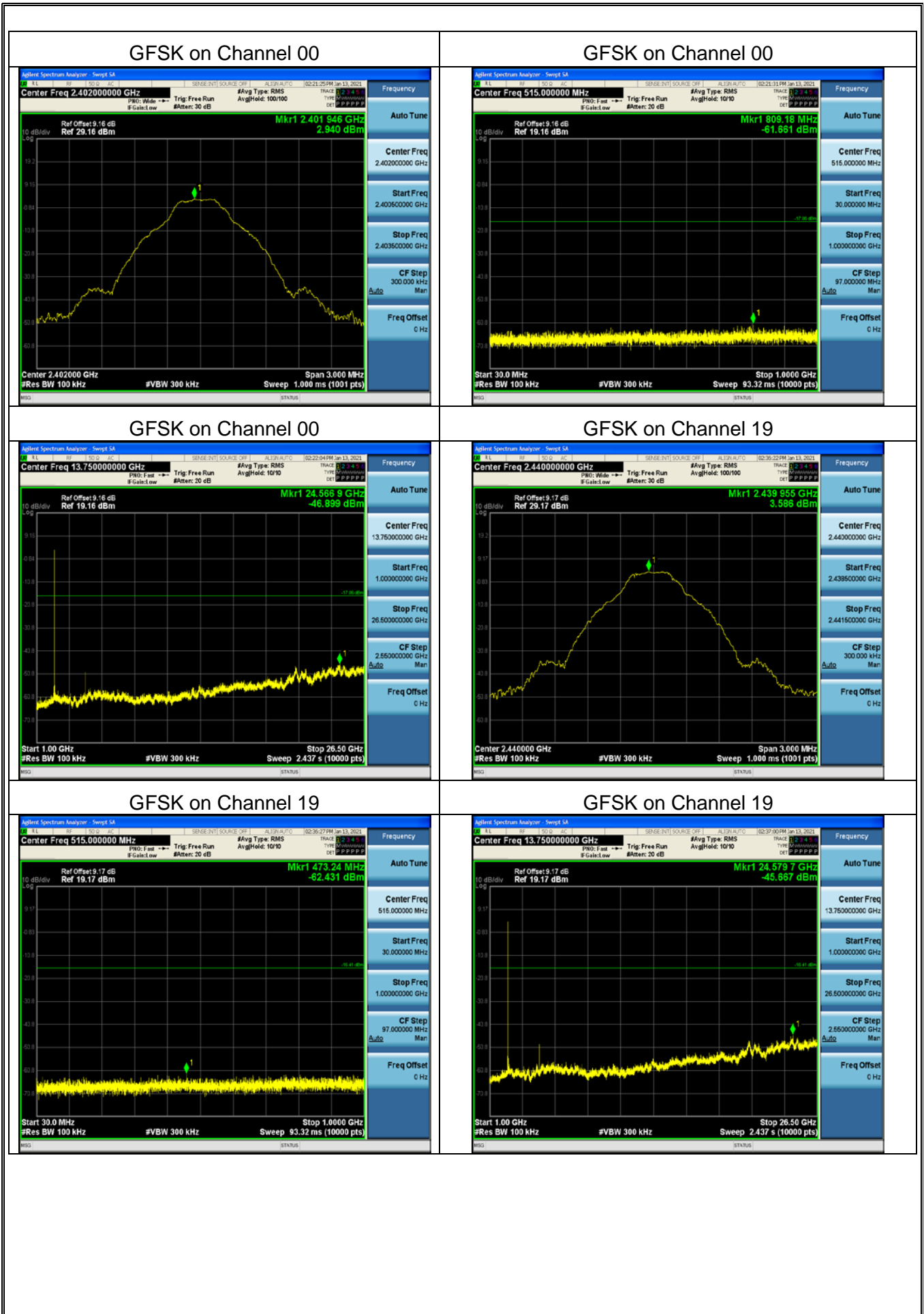



GFSK on Channel 39



GFSK on Channel 39

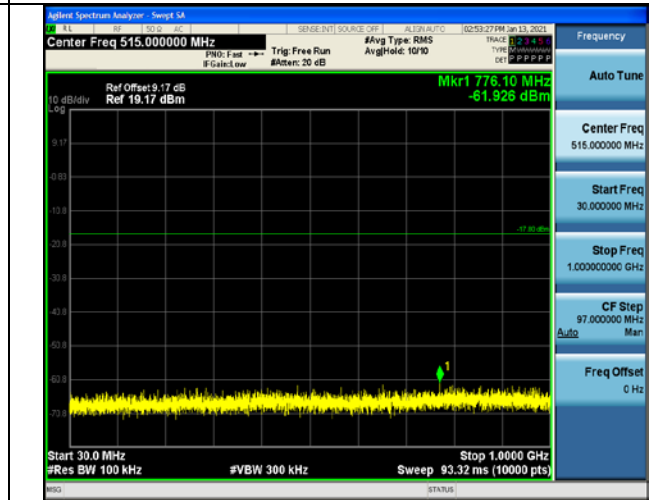

GFSK on Channel 39

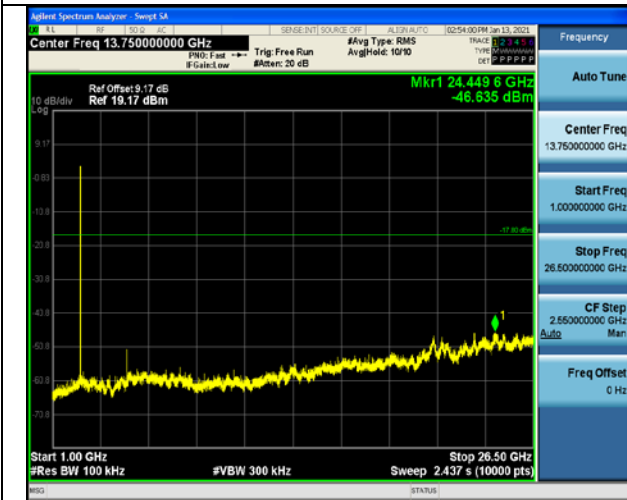



Photographs of the Test Setup

Radiated emission

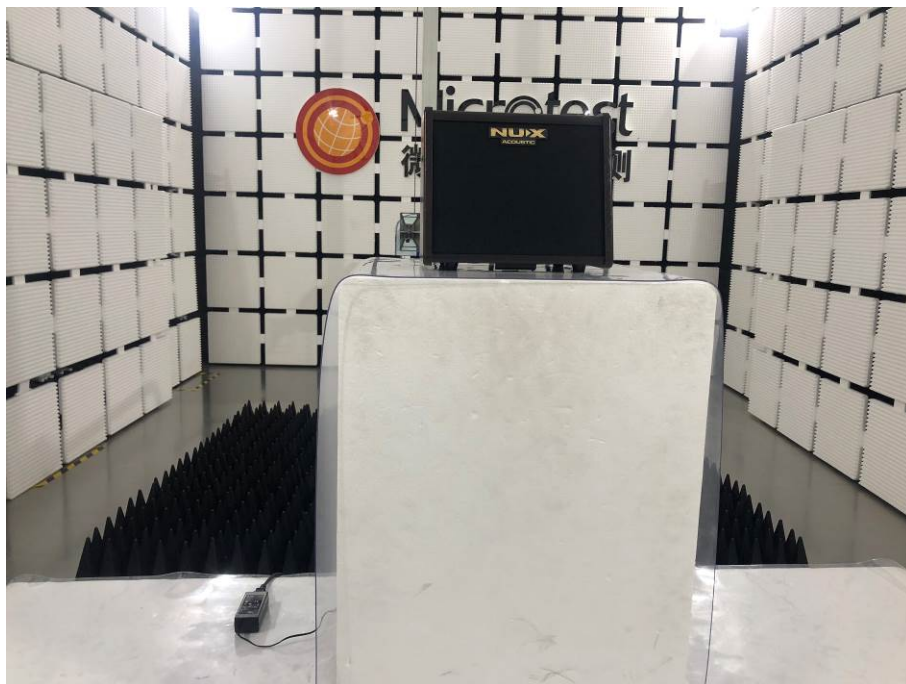



Conducted emission





Photographs of the EUT

See the APPENDIX 1- EUT PHOTO.

----END OF REPORT----