



东莞市一佳电子通讯有限公司

Antenna Test Report

- 1. Device Profile*
- 2. Antenna BT Test*
- 3. Assembly Picture*

Tester : Wang Yexin

Approval : Chen Guoqiang

Date : 2020 / 06 / 18

东莞市一佳电子通讯科技有限公司 东莞研发中心

ADDR:东莞市长安镇木鱼路元富工业区59号一佳电子1楼

Tel:0755-26462487



1. Device Profile

Device





2. Antenna BT Test

*Antenna
BT*





Agilent E5071B

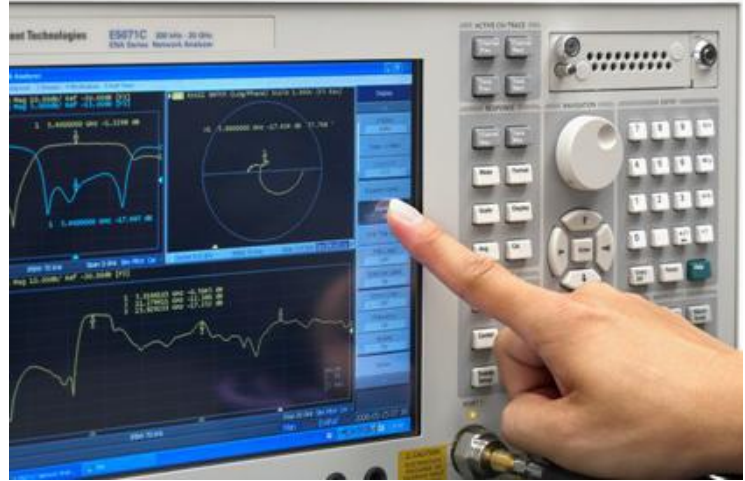

S Parameter Test // BT

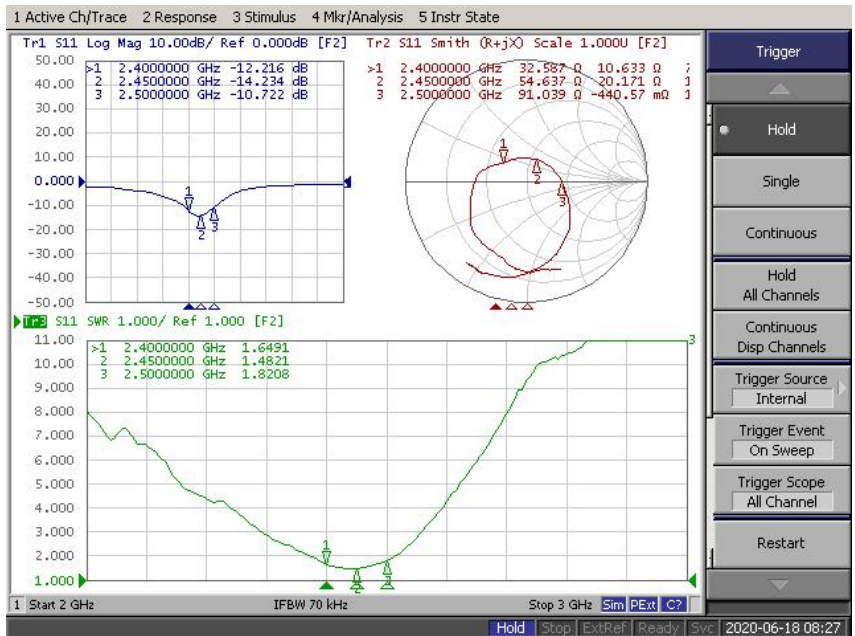



Antenna BT Matching Circuit

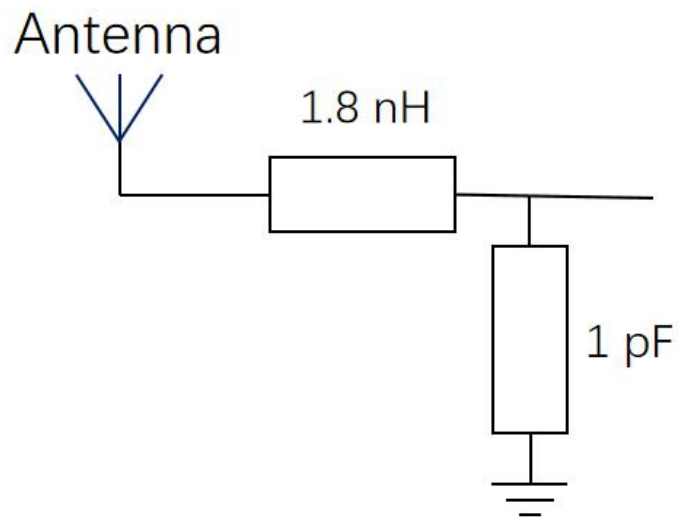



Passive Test For BT

Freq (MHz)	Effi (%)	Effi (dB)	Gain (dBi)
2400	46.6	-3.3	1.4
2410	47.2	-3.3	1.7
2420	47.4	-3.2	1.5
2430	48.9	-3.1	1.4
2440	48.8	-3.1	1.3
2450	48.9	-3.1	1.3
2460	48.9	-3.1	1.2
2470	48.4	-3.2	1.3
2480	47.0	-3.3	1.4
2490	45.5	-3.4	1.4
2500	43.3	-3.6	1.3



Test Environment

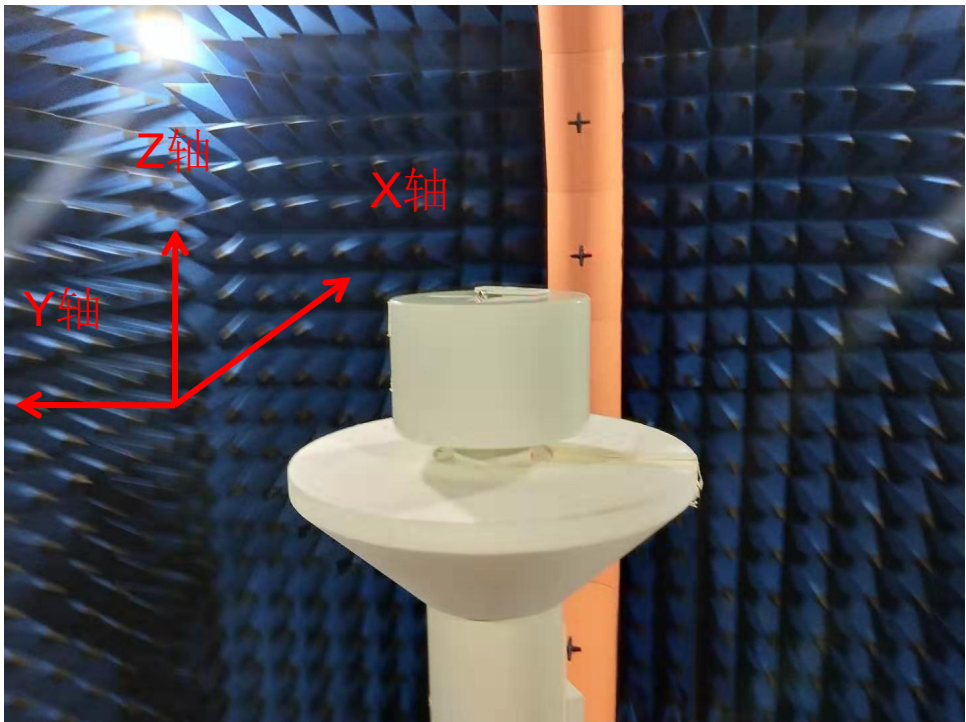
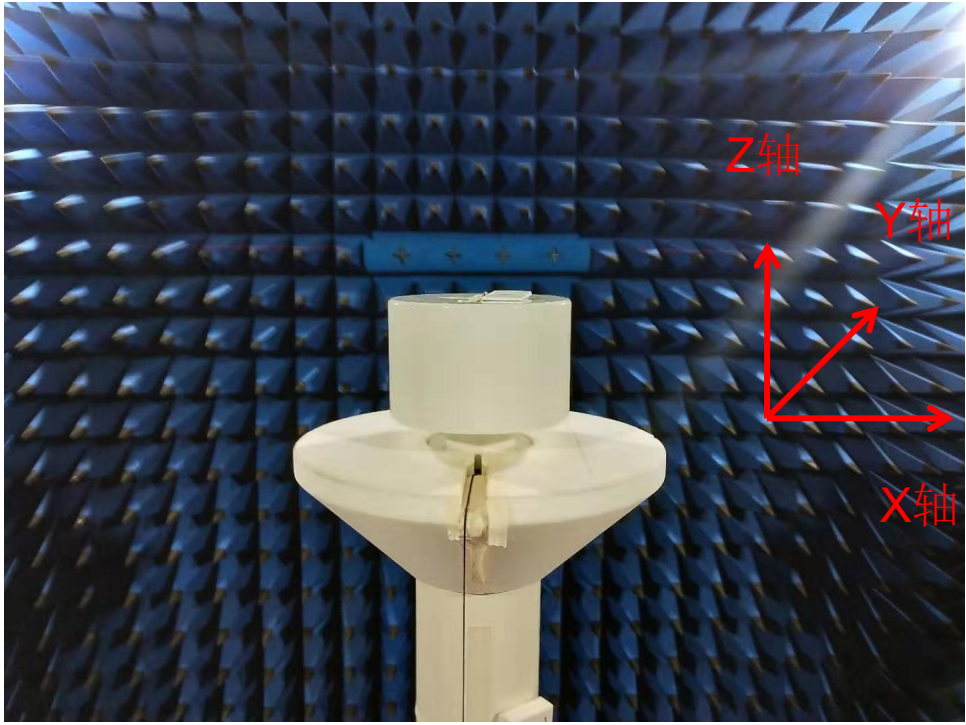

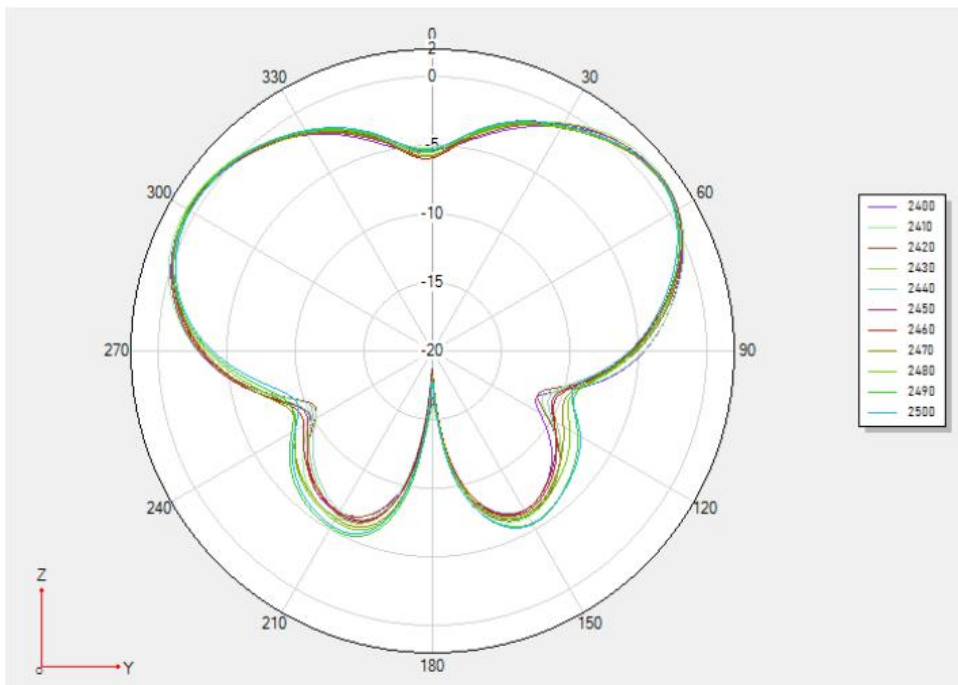
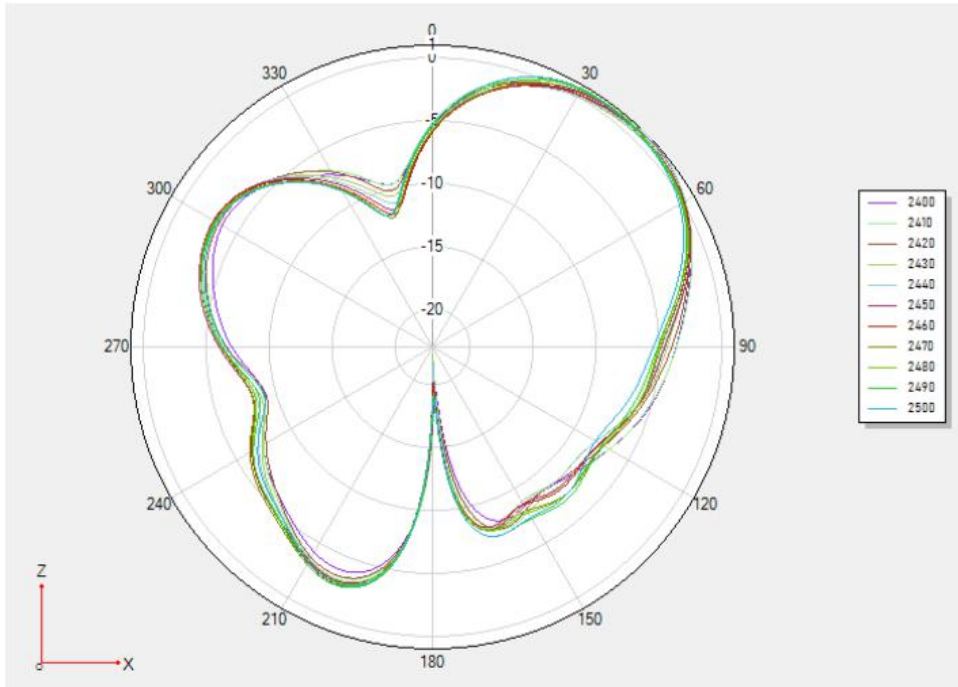

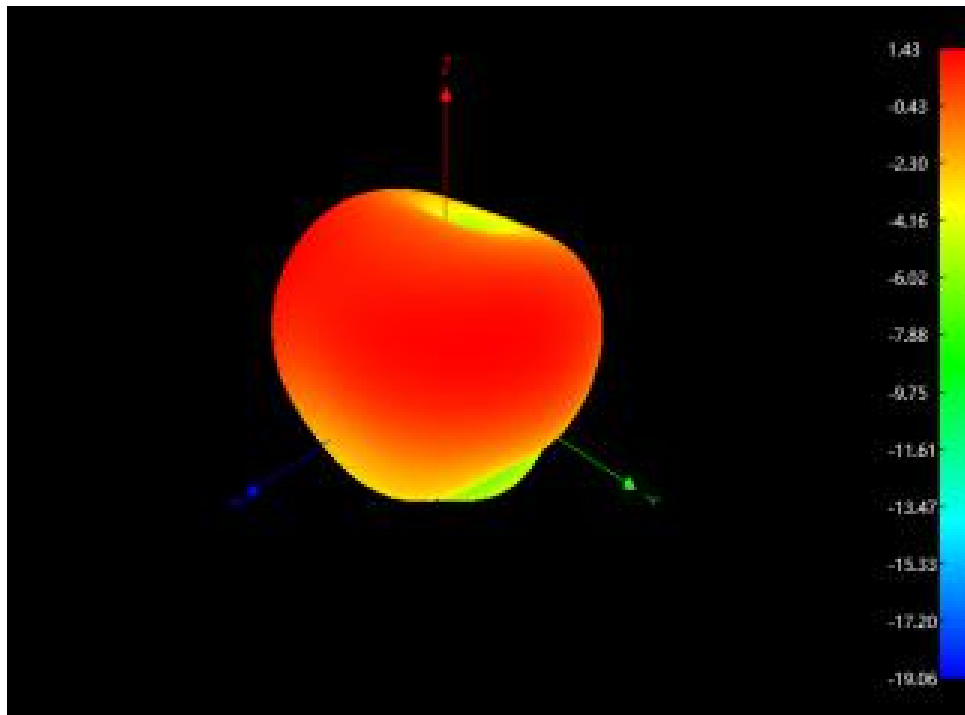
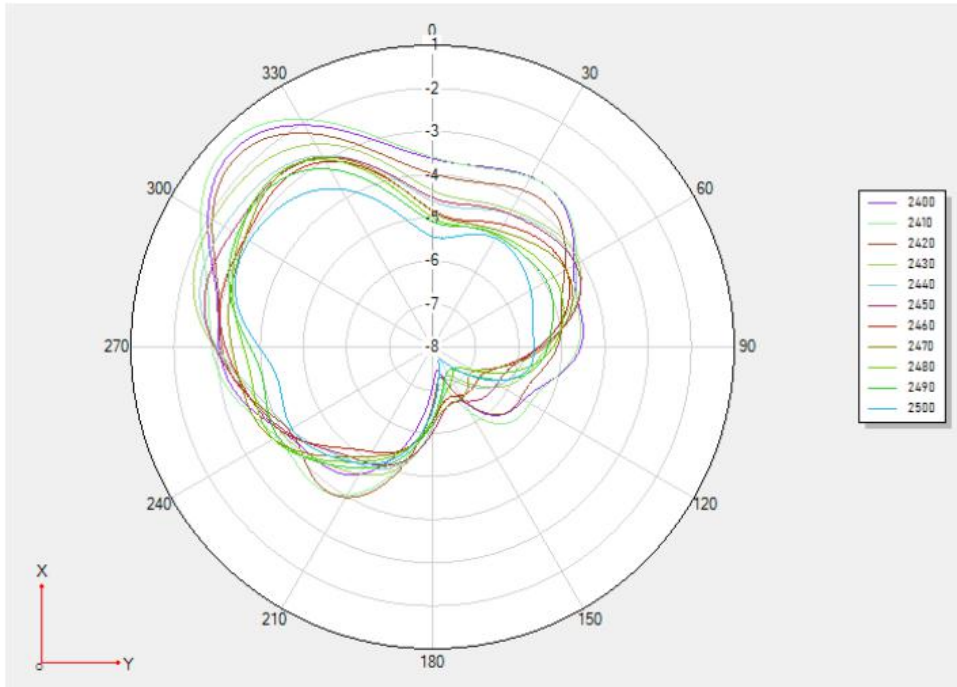



3. Assembly Drawing

BT Ant

