



# FCC TEST REPORT

Test report  
On Behalf of

**SHENZHEN JINGDU TECHNOLOGY CO.,LTD**

For  
**DSLR Wireless Microphone**

**Model No.: WXM22, WXM22A, WXM22B, WXM22C, WXM22D,  
WXM22-1, WXM22-2, WXM22-3, WXM22-4**

**FCC ID: 2A085-WXM22**

**Prepared for :** SHENZHEN JINGDU TECHNOLOGY CO.,LTD  
3F, Building D, Fuxinlin Park Hangcheng industrial Park, Qianjin 2 Road, Baoan District, ShenzhenXixiang town, China

**Prepared By :** Shenzhen HUAK Testing Technology Co., Ltd.  
1-2/F., Building B2, Junfeng Zhongcheng Zhizao Innovation Park, Heping, Fuhai Street, Bao'an District, Shenzhen, Guangdong, China

**Date of Test:** Mar. 02, 2022 ~ Mar. 22, 2022

**Date of Report:** Mar. 22, 2022

**Report Number:** HK2203020811-E



### TEST RESULT CERTIFICATION

**Applicant's name** ..... : SHENZHEN JINGDU TECHNOLOGY CO.,LTD  
**Address**..... : 3F, Building D, Fuxinlin Park Hangcheng industrial Park, Qianjin 2 Road, Baoan District, ShenzhenXixiang town, China  
**Manufacture's Name** ..... : Shenzhen LongXiang Intelligent Technology Co. Ltd.  
**Address**..... : FLOOR 4, BUILDING D, FUXINLIN INDUSTRIAL AREA, HENGCHENG INDUSTRIAL ZONE FUHUA COMMUNITY XIXIANG STREET, BAOAN DISTRICT SHENZHEN GUANGDONG CHINA

**Product description**

**Trade Mark** ..... : Bietrun, Kapebow  
**Product name**..... : DSLR Wireless Microphone  
**Model and/or type reference** : WXM22, WXM22A, WXM22B, WXM22C, WXM22D, WXM22-1, WXM22-2, WXM22-3, WXM22-4  
**Standards** ..... : FCC Rules and Regulations Part 15 Subpart C Section 15.236  
 ANSI C63.4: 2014

This publication may be reproduced in whole or in part for non-commercial purposes as long as the Shenzhen HUAK Testing Technology Co., Ltd. is acknowledged as copyright owner and source of the material. Shenzhen HUAK Testing Technology Co., Ltd. takes no responsibility for and will not assume liability for damages resulting from the reader's interpretation of the reproduced material due to its placement and context.

**Date of Test** ..... :  
**Date (s) of performance of tests**..... : Mar. 02, 2022 ~ Mar. 22, 2022  
**Date of Issue** ..... : Mar. 22, 2022  
**Test Result**..... : **Pass**

Testing Engineer : *Gary Qian*

(Gary Qian)

Technical Manager : *Zden Hu*

(Eden Hu)

Authorized Signatory : *Jason Zhou*

(Jason Zhou)

The results shown in this test report refer only to the sample(s) tested unless otherwise stated and the sample(s) are retained for 30 days only. The document is issued by HUAK, this document cannot be reproduced except in full with our prior written permission. The more details and the authenticity of the report will be confirmed at <http://www.cer-mark.com>.



# TABLE OF CONTENTS

<b>1</b>	<b>TEST SUMMARY.....</b>	<b>5</b>
1.1	TEST PROCEDURES AND RESULTS .....	5
1.2	TEST FACILITY .....	5
1.3	Measurement Uncertainty.....	6
<b>2</b>	<b>GENERAL INFORMATION.....</b>	<b>7</b>
2.1	GENERAL DESCRIPTION OF EUT .....	7
2.2	Carrier Frequency of Channels .....	8
2.3	Operation of EUT during testing .....	8
2.4	DESCRIPTION OF TEST SETUP.....	9
2.5	Description of Support Units .....	9
<b>3</b>	<b>TEST RESULTS AND MEASUREMENT DATA .....</b>	<b>11</b>
3.1	CONDUCTED EMISSIONS TEST .....	11
3.2	RADIATED EMISSION TEST .....	15
3.4	Conducted Output Power.....	20
3.5	OCCUPIED BANDWIDTH MEASUREMENT.....	21
3.5	Necessary bandwidth.....	24
3.6	FREQUENCY STABILITY.....	28
3.7	ANTENNA REQUIREMENT.....	30
<b>4</b>	<b>PHOTOGRAPH OF TEST .....</b>	<b>31</b>
<b>5</b>	<b>PHOTOGRAPH OF EUT.....</b>	<b>33</b>

The results shown in this test report refer only to the sample(s) tested unless otherwise stated and the sample(s) are retained for 30 days only. The document is issued by HUAK, this document cannot be reproduced except in full with our prior written permission. The more details and the authenticity of the report will be confirmed at <http://www.cer-mark.com>.

**HUAK Testing Lab** TEL : +86-755 2302 9901 FAX : +86-755 2302 9901 E-mail : [service@cer-mark.com](mailto:service@cer-mark.com)

1-2/F., Building B2, Junfeng Zhongcheng Zhizao Innovation Park, Heping, Fuhai Street, Bao'an District, Shenzhen, Guangdong, China



**\*\* Modified History \*\***

<b>Revison</b>	<b>Description</b>	<b>Issued Data</b>	<b>Remark</b>
Revison 1.0	Initial Test Report Release	Mar. 22, 2022	Jason Zhou

The results shown in this test report refer only to the sample(s) tested unless otherwise stated and the sample(s) are retained for 30 days only. The document is issued by HUAK, this document cannot be reproduced except in full with our prior written permission. The more details and the authenticity of the report will be confirmed at <http://www.cer-mark.com>.

**HUAK Testing Lab** TEL : +86-755 2302 9901 FAX : +86-755 2302 9901 E-mail : [service@cer-mark.com](mailto:service@cer-mark.com)

1-2/F., Building B2, Junfeng Zhongcheng Zhizao Innovation Park, Heping, Fuhai Street, Bao'an District, Shenzhen, Guangdong, China



# 1 TEST SUMMARY

## 1.1 TEST PROCEDURES AND RESULTS

Requirement	CFR 47 Section	Result
Conducted Emission	15.207	PASS
Conducted Peak Output Power	15.236(d)(1)	PASS
Occupied Bandwidth Emission	15.236(f)(2)	PASS
Radiated Spurious Emission	15.236(g)	PASS
Frequency Stability	15.236(f)(3)	PASS
Antenna Requirement	15.203	PASS

*Note:*

- 1. PASS: Test item meets the requirement.
- 2. Fail: Test item does not meet the requirement.
- 3. N/A: Test case does not apply to the test object.
- 4. The test result judgment is decided by the limit of test standard.

## 1.2 TEST FACILITY

### Information of the Test Laboratory

Shenzhen HUAK Testing Technology Co., Ltd.

Add.: 1-2/F., Building B2, Junfeng Zhongcheng Zhizao Innovation Park, Heping, Fuhai Street, Bao'an District, Shenzhen, Guangdong, China

### Testing Laboratory Authorization :

- A2LA Accreditation Code is 4781.01.
- FCC Designation Number is CN1229.
- Canada IC CAB identifier is CN0045.
- CNAS Registration Number is L9589.





### 1.3 Measurement Uncertainty

The reported uncertainty of measurement  $y \pm U$ , where expanded uncertainty  $U$  is based on a standard uncertainty multiplied by a coverage factor of  $k=2$ , providing a level of confidence of approximately 95 %.

No.	Item	MU
1	Conducted Emission	$\pm 2.56\text{dB}$
2	RF power, conducted	$\pm 0.12\text{dB}$
3	Spurious emissions, conducted	$\pm 0.11\text{dB}$
4	All emissions, radiated(<1G)	$\pm 3.92\text{dB}$
5	All emissions, radiated(>1G)	$\pm 4.28\text{dB}$
6	Temperature	$\pm 0.1^\circ\text{C}$
7	Humidity	$\pm 1.0\%$



## 2 GENERAL INFORMATION

### 2.1 GENERAL DESCRIPTION OF EUT

Equipment	DSLW Wireless Microphone
Model Name	WXM22
Serial No.	WXM22A, WXM22B, WXM22C, WXM22D, WXM22-1, WXM22-2, WXM22-3, WXM22-4
Model Difference	All model's the function, software and electric circuit are the same, only model named and Trade Mark different. Test sample model: WXM22.
Trade Mark	Bietrun, Kapebow
FCC ID	<b>2A085-WXM22</b>
Hardware Version:	V1.0
Software Version:	V1.0
Operation frequency	560.15MHz-589.55MHz
Number of Channels	50CH
Antenna Type	Internal Antenna
Antenna Gain	1dBi
Modulation Type	FM
Power Source	DC 5V from USB or DC 3.7V from Battery

The results shown in this test report refer only to the sample(s) tested unless otherwise stated and the sample(s) are retained for 30 days only. The document is issued by HUAK, this document cannot be reproduced except in full with our prior written permission. The more details and the authenticity of the report will be confirmed at <http://www.cer-mark.com>.



### 2.2 Carrier Frequency of Channels

Channel	Frequency(MHz)	Channel	Frequency(MHz)
1	560.15	26	575.15
2	560.75	27	575.75
3	561.35	28	576.35
4	561.95	29	576.95
5	562.55	30	577.55
6	563.15	31	578.15
7	563.75	32	578.75
8	564.35	33	579.35
9	564.95	34	579.95
10	565.55	35	580.55
11	566.15	36	581.15
12	566.75	37	581.75
13	567.35	38	582.35
14	567.95	39	582.95
15	568.55	40	583.55
16	569.15	41	584.15
17	569.75	42	584.75
18	570.35	43	585.35
19	570.95	44	585.95
20	571.55	45	586.55
21	572.15	46	587.15
22	572.75	47	587.75
23	573.35	48	588.35
24	573.95	49	588.95
25	574.55	50	589.55

### 2.3 Operation of EUT during testing

Operating Mode

The mode is used: **Transmitting mode**

CH1: 560.15MHz

CH25: 574.55MHz

CH50: 589.55MHz

The results shown in this test report refer only to the sample(s) tested unless otherwise stated and the sample(s) are retained for 30 days only. The document is issued by HUAKE, this document cannot be reproduced except in full with our prior written permission. The more details and the authenticity of the report will be confirmed at <http://www.cer-mark.com>.





### 2.4 DESCRIPTION OF TEST SETUP

Operation of EUT during conducted and radiation below 1GHz testing:

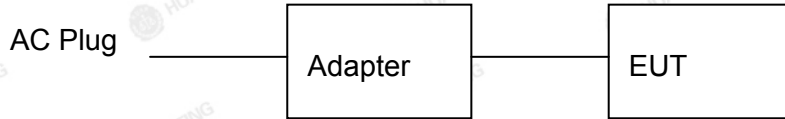

Operation of EUT during radiation above 1GHz testing:



Adapter information

Model: HW-059200CHQ

Input: 100-240V, 50-60Hz, 0.5A

Output: 5VDC, 2A

### 2.5 Description of Support Units

The EUT has been tested as an independent unit together with other necessary accessories or support units. The following support units or accessories were used to form a representative test configuration during the tests.

Description	Model No.	Manufacturer	Remark	Certificate
Adapter	HW-059200CHQ	/	/	/
/	/	/	/	/

**Note:**

1. All the equipment/cables were placed in the worst-case configuration to maximize the emission during the test.
2. Grounding was established in accordance with the manufacturer's requirements and conditions for the intended use.
3. For conducted measurements (Output Power, 6dB Emission Bandwidth, Power Spectral Density, Spurious Emissions), the antenna of EUT is connected to the test equipment via temporary antenna connector, the antenna connector is soldered on the antenna port of EUT, and the temporary antenna connector is listed in the Test Instruments.

**2.6 MEASUREMENT INSTRUMENTS LIST**

Item	Equipment	Manufacturer	Model No.	Serial No.	Last Cal.	Cal. Interval
1.	L.I.S.N. Artificial Mains Network	R&S	ENV216	HKE-002	Dec. 09, 2021	1 Year
2.	Receiver	R&S	ESCI 7	HKE-010	Dec. 09, 2021	1 Year
3.	RF automatic control unit	Tonscend	JS0806-2	HKE-060	Dec. 09, 2021	1 Year
4.	Spectrum analyzer	R&S	FSP40	HKE-025	Dec. 09, 2021	1 Year
5.	Spectrum analyzer	Agilent	N9020A	HKE-048	Dec. 09, 2021	1 Year
6.	Preamplifier	Schwarzbeck	BBV 9743	HKE-006	Dec. 09, 2021	1 Year
7.	EMI Test Receiver	Rohde & Schwarz	ESCI 7	HKE-010	Dec. 09, 2021	1 Year
8.	Bilog Broadband Antenna	Schwarzbeck	VULB9163	HKE-012	Dec. 09, 2021	1 Year
9.	Loop Antenna	Schwarzbeck	FMZB 1519B	HKE-014	Dec. 09, 2021	1 Year
10.	Horn Antenna	Schwarzbeck	9120D	HKE-013	Dec. 09, 2021	1 Year
11.	Pre-amplifier	EMCI	EMC051845SE	HKE-015	Dec. 09, 2021	1 Year
12.	Pre-amplifier	Agilent	83051A	HKE-016	Dec. 09, 2021	1 Year
13.	EMI Test Software EZ-EMC	Tonscend	JS1120-B Version	HKE-083	Dec. 09, 2021	N/A
14.	Power Sensor	Agilent	E9300A	HKE-086	Dec. 09, 2021	1 Year
15.	Spectrum analyzer	Agilent	N9020A	HKE-048	Dec. 09, 2021	1 Year
16.	Signal generator	Agilent	N5182A	HKE-029	Dec. 09, 2021	1 Year
17.	Signal Generator	Agilent	83630A	HKE-028	Dec. 09, 2021	1 Year
18.	Shielded room	Shiel Hong	4*3*3	HKE-039	Dec. 09, 2021	1 Year
19.	Power Meter	R&S	NRVD	SEL0069	Dec. 09, 2021	1 Year
20.	High Gain Antenna	Schwarzbeck	LB-180400KF	HKE-054	Dec. 09, 2021	1 Year

The results shown in this test report refer only to the sample(s) tested unless otherwise stated and the sample(s) are retained for 30 days only. The document is issued by HUAKE, this document cannot be reproduced except in full with our prior written permission. The more details and the authenticity of the report will be confirmed at <http://www.cer-mark.com>.

**HUAKE Testing Lab** TEL : +86-755 2302 9901 FAX : +86-755 2302 9901 E-mail : [service@cer-mark.com](mailto:service@cer-mark.com)

1-2/F., Building B2, Junfeng Zhongcheng Zhizao Innovation Park, Heping, Fuhai Street, Bao'an District, Shenzhen, Guangdong, China



### 3 TEST RESULTS AND MEASUREMENT DATA

#### 3.1 CONDUCTED EMISSIONS TEST

##### LIMIT

According to FCC CFR Title 47 Part 15 Subpart C Section 15.207 and RSS Gen 8.8, AC Power Line Conducted Emissions Limits for Licence-Exempt Radio Apparatus as below:

Frequency range (MHz)	Limit (dBuV)	
	Quasi-peak	Average
0.15-0.5	66 to 56*	56 to 46*
0.5-5	56	46
5-30	60	50

\* Decreases with the logarithm of the frequency.

##### TEST CONFIGURATION

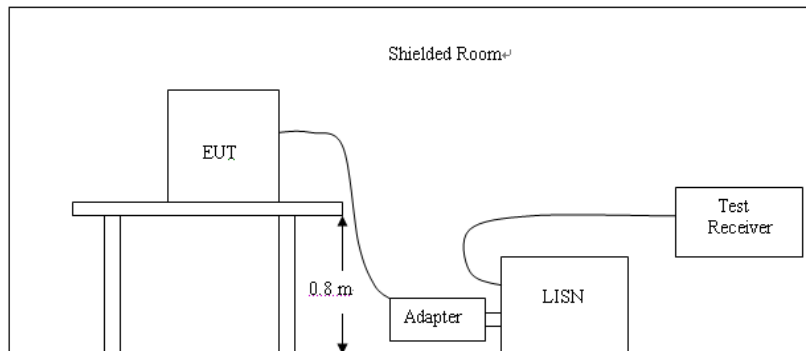

**TEST PROCEDURE**

1. The equipment was set up as per the test configuration to simulate typical actual usage per the user's manual. The EUT is a tabletop system; a wooden table with a height of 0.8 meters is used and is placed on the ground plane as per ANSI C63.10:2013.
2. Support equipment, if needed, was placed as per ANSI C63.10:2013
3. All I/O cables were positioned to simulate typical actual usage as per ANSI C63.10:2013.
4. The adapter received AC120V/60Hz power through a Line Impedance Stabilization Network (LISN) which supplied power source and was grounded to the ground plane.
5. All support equipments received AC power from a second LISN, if any.
6. The EUT test program was started. Emissions were measured on each current carrying line of the EUT using a spectrum Analyzer / Receiver connected to the LISN powering the EUT. The LISN has two monitoring points: Line 1 (Hot Side) and Line 2 (Neutral Side). Two scans were taken: one with Line 1 connected to Analyzer / Receiver and Line 2 connected to a 50 ohm load; the second scan had Line 1 connected to a 50 ohm load and Line 2 connected to the Analyzer / Receiver.
7. Analyzer / Receiver scanned from 150 KHz to 30MHz for emissions in each of the test modes.
8. During the above scans, the emissions were maximized by cable manipulation.





TEST RESULTS

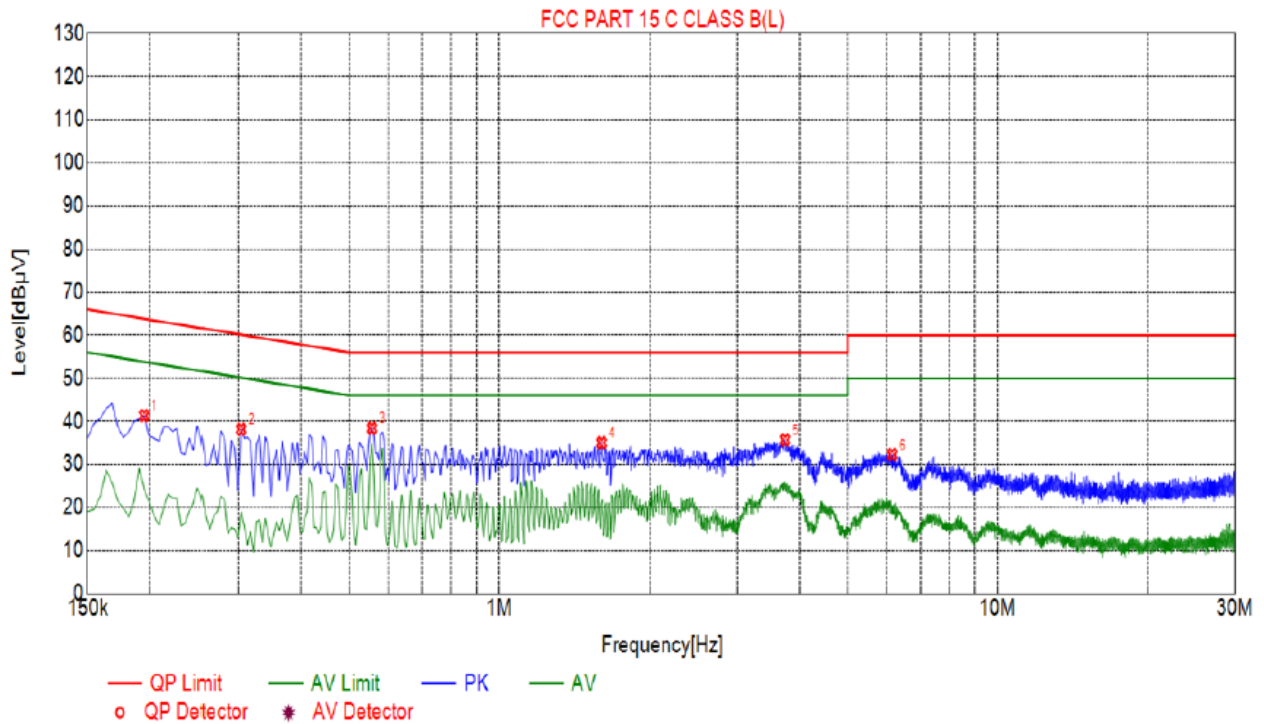

Suspected List								
NO.	Freq. [MHz]	Level [dBµV]	Factor [dB]	Limit [dBµV]	Margin [dB]	Reading [dBµV]	Detector	Type
1	0.1950	41.34	20.03	63.82	22.48	21.31	PK	L
2	0.3030	38.17	20.04	60.16	21.99	18.13	PK	L
3	0.5550	38.42	20.06	56.00	17.58	18.36	PK	L
4	1.6035	35.03	20.11	56.00	20.97	14.92	PK	L
5	3.7455	35.69	20.25	56.00	20.31	15.44	PK	L
6	6.1440	32.29	20.23	60.00	27.71	12.06	PK	L

The results shown in this test report refer only to the sample(s) tested unless otherwise stated and the sample(s) are retained for 30 days only. The document is issued by HUAKE, this document cannot be reproduced except in full with our prior written permission. The more details and the authenticity of the report will be confirmed at <http://www.cer-mark.com>.



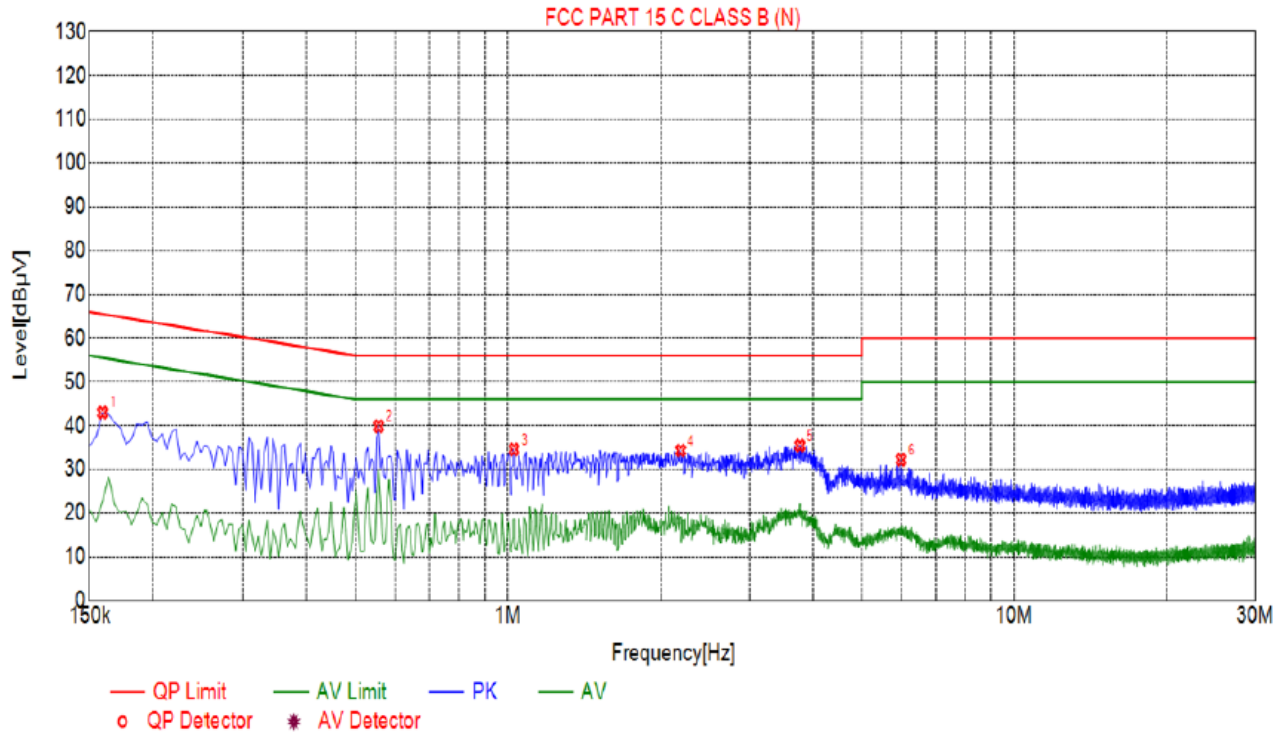

### Suspected List

NO.	Freq. [MHz]	Level [dBµV]	Factor [dB]	Limit [dBµV]	Margin [dB]	Reading [dBµV]	Detector	Type
1	0.1590	43.00	20.01	65.52	22.52	22.99	PK	N
2	0.5550	39.87	20.06	56.00	16.13	19.81	PK	N
3	1.0275	34.59	20.07	56.00	21.41	14.52	PK	N
4	2.1930	34.32	20.17	56.00	21.68	14.15	PK	N
5	3.7725	35.45	20.25	56.00	20.55	15.20	PK	N
6	5.9820	32.22	20.23	60.00	27.78	11.99	PK	N

Remark: Margin = Limit – Level

Correction factor = Cable lose + LISN insertion loss

Level=Test receiver reading + correction factor

### 3.2 RADIATED EMISSION TEST

#### Limit

Emissions within the band from one megahertz below to one megahertz above the carrier frequency shall comply with the emission mask in §8.3 of ETSI EN 300 422-1 V1.4.2 (2011-08).

Emissions outside of this band shall comply with the limits specified in section 8.4 of ETSI EN 300 422-1 V1.4.2 (2011-08).

#### TEST CONFIGURATION

(A) Radiated Emission Test Set-Up, Frequency Below 30MHz

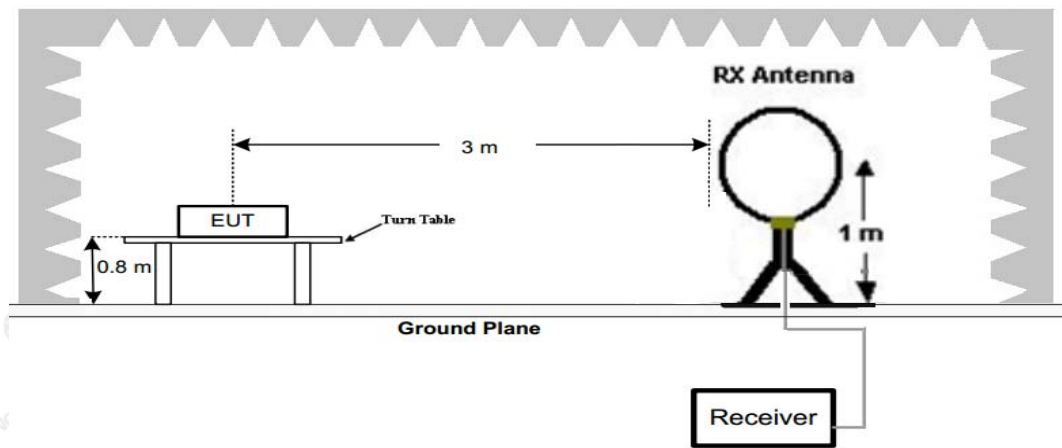

(B) Radiated Emission Test Set-Up, Frequency below 1000MHz

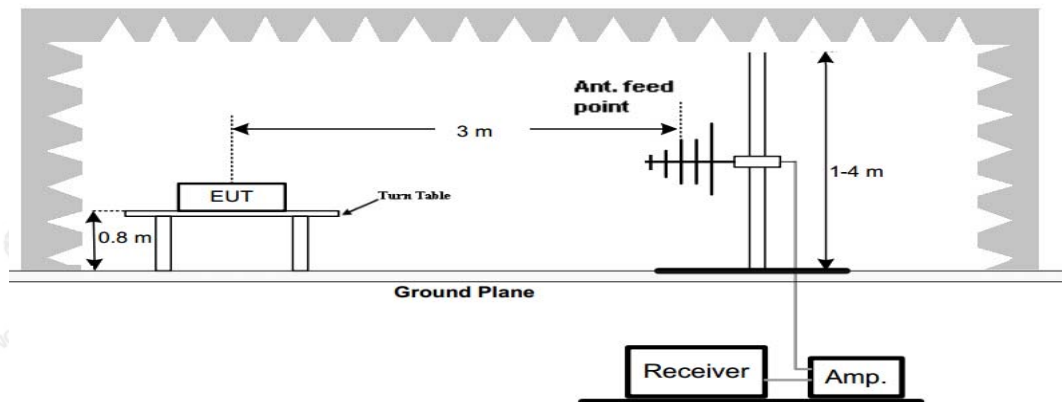

(C) Radiated Emission Test Set-Up, Frequency above 1000MHz

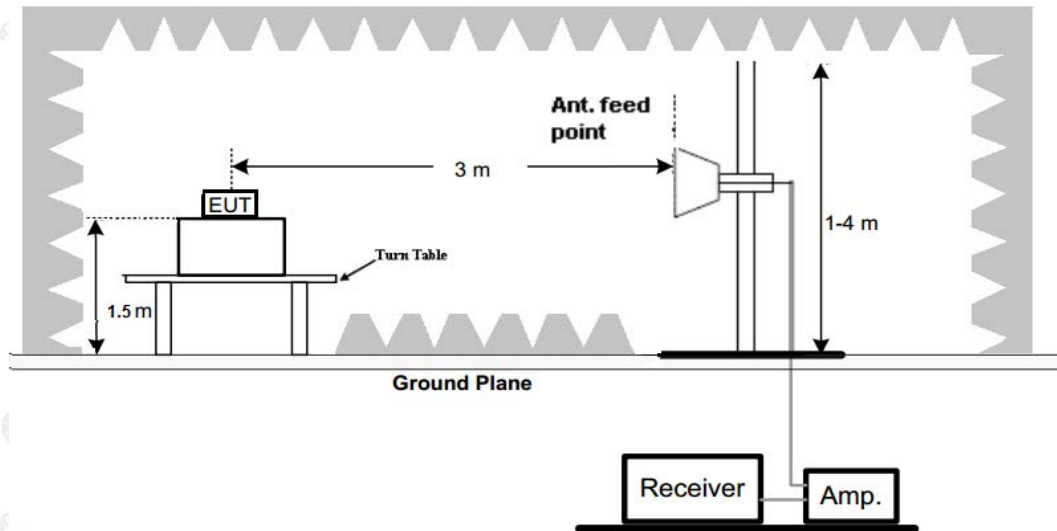

Frequency :9kHz-30MHz	Frequency :30MHz-1GHz	Frequency :Above 1GHz
RBW=10KHz,	RBW=120KHz,	RBW=1MHz,
VBW =30KHz	VBW=300KHz	VBW=3MHz(Peak)
Sweep time= Auto	Sweep time= Auto	Sweep time= Auto
Trace = max hold	Trace = max hold	Trace = max hold
Detector function = peak	Detector function = peak	Detector function = peak

**Test Procedure**

- 1.The setup of EUT is according with per TIA/EIA Standard 603 and ANSI C63.4-2014 measurement procedure.
- 2.The measurement antenna was placed at a distance of 3 meters from the EUT. During the tests, the antenna height and polarization as well as EUT azimuth were varied in order to identify the maximum level of emissions from the EUT. The test was performed by placing the EUT on 3-orthogonal axis.
- 3.The frequency range up to tenth harmonic of the fundamental frequency was investigated.
- 4.Remove the EUT and replace it with substitution antenna. A signal generator was connected to the substitution antenna by a non-radiating cable.



**TEST RESULTS**

Below 1GHz Test Results:(Show only the worst test results)

Antenna polarity: H

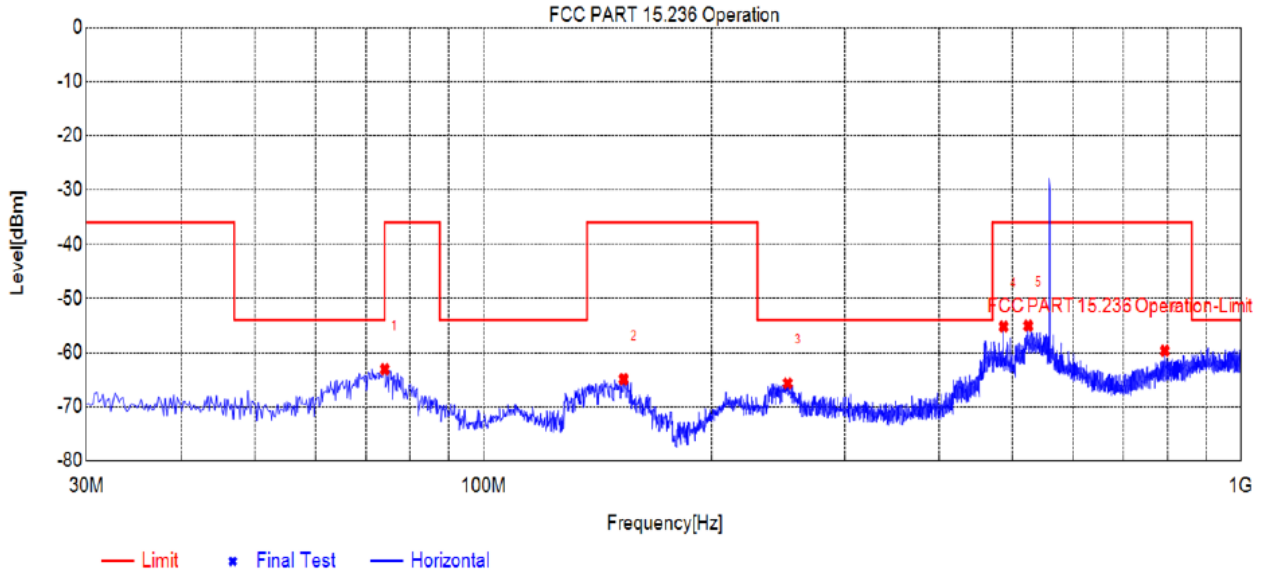

Suspected List							
NO.	Freq. [MHz]	Reading [dBm]	Level [dBm]	Limit [dBm]	Margin [dB]	Factor [dB]	Polarity
1	74.0468	-67.07	-63.11	-36.00	27.11	3.96	Horizontal
2	153.020	-66.85	-64.92	-36.00	28.92	1.93	Horizontal
3	251.980	-71.99	-65.66	-54.00	11.66	6.33	Horizontal
4	486.379	-59.96	-55.21	-36.00	19.21	4.75	Horizontal
5	523.634	-60.08	-55.07	-36.00	19.07	5.01	Horizontal
6	793.736	-69.55	-59.69	-36.00	23.69	9.86	Horizontal

Remark: Factor = Cable loss + Antenna factor – Preamplifier; Level = Reading + Factor; Margin = Limit – Level;





Antenna polarity: V

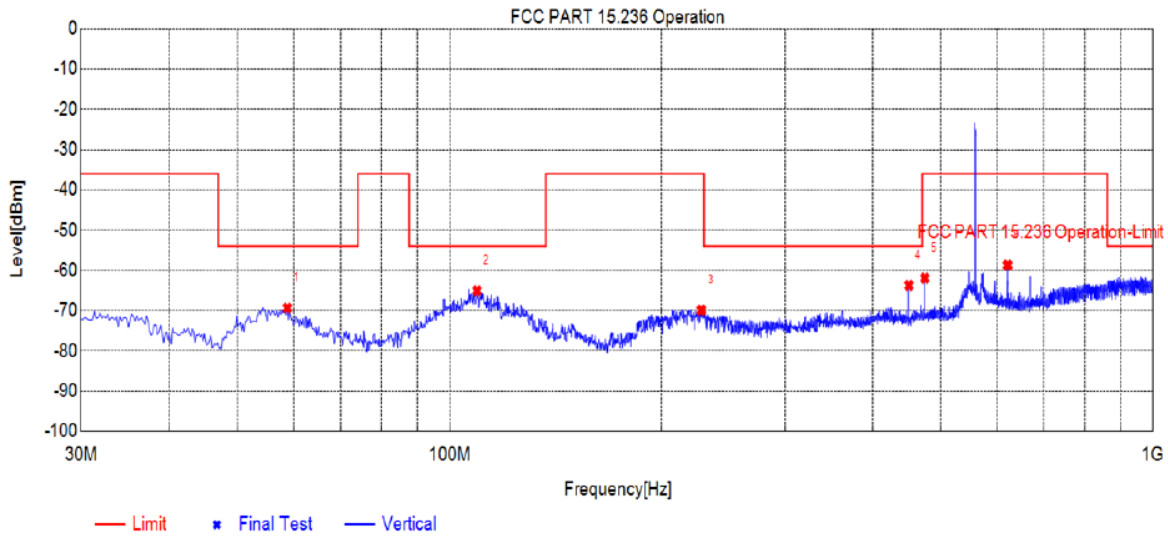

Suspected List							
NO.	Freq. [MHz]	Reading [dBm]	Level [dBm]	Limit [dBm]	Margin [dB]	Factor [dB]	Polarity
1	58.7177	-64.76	-69.33	-54.00	15.33	-4.57	Vertical
2	109.361	-77.66	-65.07	-54.00	11.07	12.59	Vertical
3	227.919	-67.81	-69.90	-36.00	33.90	-2.09	Vertical
4	449.705	-66.79	-63.75	-54.00	9.75	3.04	Vertical
5	474.154	-66.15	-61.95	-36.00	25.95	4.20	Vertical
6	621.624	-65.85	-58.73	-36.00	22.73	7.12	Vertical

Remark: Factor = Cable loss + Antenna factor – Pre-amplifier; Level = Reading + Factor; Margin = Limit – Level;

Remark:

- (1) Measuring frequencies from 9 KHz to the 1 GHz, Radiated emission test from 9KHz to 30MHz was verified, and no any emission was found except system noise floor.
- (2) The IF bandwidth of EMI Test Receiver between 30MHz to 1GHz was 120KHz, 1 MHz for measuring above 1 GHz, below 30MHz was 10KHz.

### Harmonics and Spurious Emissions

#### Frequency Range (9 kHz-30MHz)

Frequency (MHz)	Level@3m (dBµV/m)	Limit@3m (dBµV/m)
--	--	--
--	--	--
--	--	--
--	--	--

Note: 1. Emission Level = Reading + Cable loss + Antenna factor - Amp factor

2. The emission levels are 20 dB below the limit value, which are not reported. It is deemed to comply with the requirement





ABOVE 1GHz Test Results:  
Transmitting at 560.15MHz

Frequency (MHz)	Meter Reading (dBm)	Factor (dB)	Emission Level (dBm)	Limits (dBm)	Margin (dB)	Value Type
1120.30	-35.16	-5.81	-40.97	-30	-10.97	Horizontal
1120.30	-37.77	-5.81	-43.58	-30	-13.58	Vertical
1680.45	-34.52	-6.03	-40.55	-30	-10.55	Horizontal
1680.45	-36.11	-6.03	-42.14	-30	-12.14	Vertical

Remark: Factor = Antenna Factor + Cable Loss – Pre-amplifier.

Transmitting at 589.55MHz

Frequency (MHz)	Meter Reading (dBm)	Factor (dB)	Emission Level (dBm)	Limits (dBm)	Margin (dB)	Value Type
1179.10	-36.76	-6.35	-43.11	-30	-13.11	Horizontal
1179.10	-37.02	-6.35	-43.37	-30	-13.37	Vertical
1768.65	-36.88	-6.48	-43.36	-30	-13.36	Horizontal
1768.65	-34.02	-6.48	-40.5	-30	-10.5	Vertical

Remark: Factor = Antenna Factor + Cable Loss – Pre-amplifier.

Remark:

- (1) Measuring frequencies from 1 GHz to the 18 GHz.
- (2) All modes of operation were investigated and the worst-case emissions are reported.
- (3) The emissions are attenuated more than 20dB below the permissible limits are not record in the report.

### 3.4 Conducted Output Power

#### Limit

According to FCC 15.236(d)(1), for low power auxiliary station operating in the 470-608, and 614-698 MHz bands, In the bands allocated and assigned for broadcast television and in the 600 MHz service band: 50 mW EIRP

#### TEST CONFIGURATION

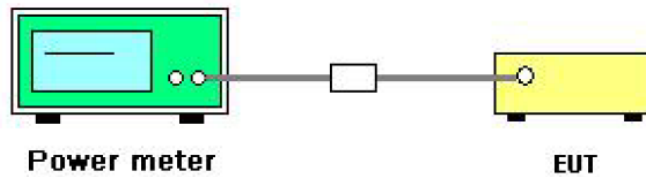

#### Test Procedure:

Remove the antenna from the EUT and then connect a low loss RF cable from the antenna port to the power sensor.

#### Test Results:

Test Channel	frequency (MHz)	Conducted Output Power (dBm)	ANT Gain (dBi)	EIRP (dBm)	Limit (dBm)	Result
CH1	560.15	2.25	1	3.25	17	PASS
CH25	574.55	2.70	1	3.70		PASS
CH50	589.55	0.72	1	1.72		PASS

### 3.5 OCCUPIED BANDWIDTH MEASUREMENT

#### Limit

According to FCC 15.236(f)(2), The operating frequency within a permissible band of operation as defined in paragraph (c) must comply with the following requirements.

- (1) The frequency selection shall be offset from the upper or lower band limits by 25 kHz or an integral multiple thereof.
- (2) One or more adjacent 25 kHz segments within the assignable frequencies may be combined to form a channel whose maximum bandwidth shall not exceed 200 kHz. The operating bandwidth shall not exceed 200kHz.

Emissions within the band from one megahertz below to one megahertz above the carrier frequency shall comply with the emission mask in Section 8.3 of ETSI EN 300 422-1 V1.4.2 (2011-08) (incorporated by reference, see §15.38). Emissions outside this band shall comply with the limit specified at the edges of the ETSI mask

#### TEST CONFIGURATION

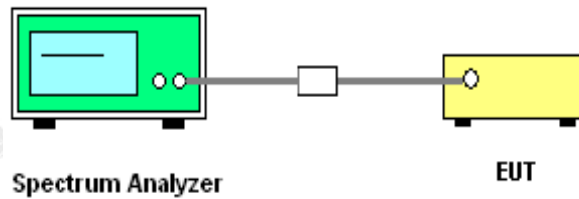

#### Test Procedure:

According to TIA-603 for additional Test Set-Up procedures, the occupied bandwidth of emission was measured with a Spectrum Analyzer connected to the antenna terminal while EUT was operating in 2.5kHz tone at an input level 16 dB greater than that necessary to produce 50 percent modulation. Then mark the -26dB Bandwidth and record it.

#### Test Results:

Test Channel	frequency (MHz)	-20Bandwidth (kHz)	99%Bandwidth (kHz)	Limit (kHz)	Result
CH1	560.15	74.59	62.335	200	PASS
CH25	574.55	80.30	65.784		PASS
CH50	589.55	79.67	66.553		PASS

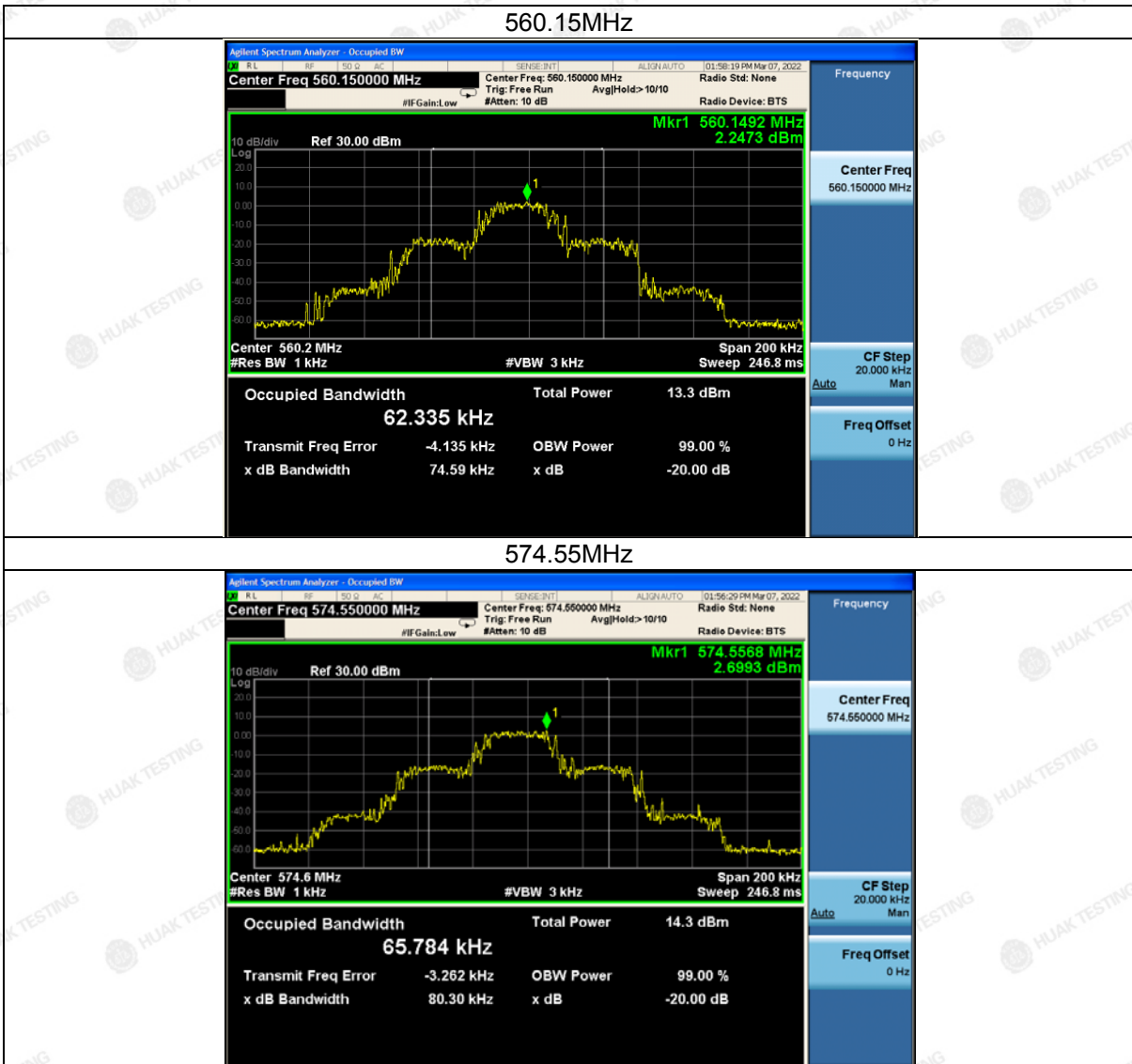

The results shown in this test report refer only to the sample(s) tested unless otherwise stated and the sample(s) are retained for 30 days only. The document is issued by HUAKE, this document cannot be reproduced except in full with our prior written permission. The more details and the authenticity of the report will be confirmed at <http://www.cer-mark.com>.





The results shown in this test report refer only to the sample(s) tested unless otherwise stated and the sample(s) are retained for 30 days only. The document is issued by HUAKE, this document cannot be reproduced except in full with our prior written permission. The more details and the authenticity of the report will be confirmed at <http://www.cer-mark.com>.

HUAKE Testing Lab TEL : +86-755 2302 9901 FAX : +86-755 2302 9901 E-mail : [service@cer-mark.com](mailto:service@cer-mark.com)

1-2/F., Building B2, Junfeng Zhongcheng Zhizao Innovation Park, Heping, Fuhai Street, Bao'an District, Shenzhen, Guangdong, China



### 3.5 Necessary bandwidth

#### Limit

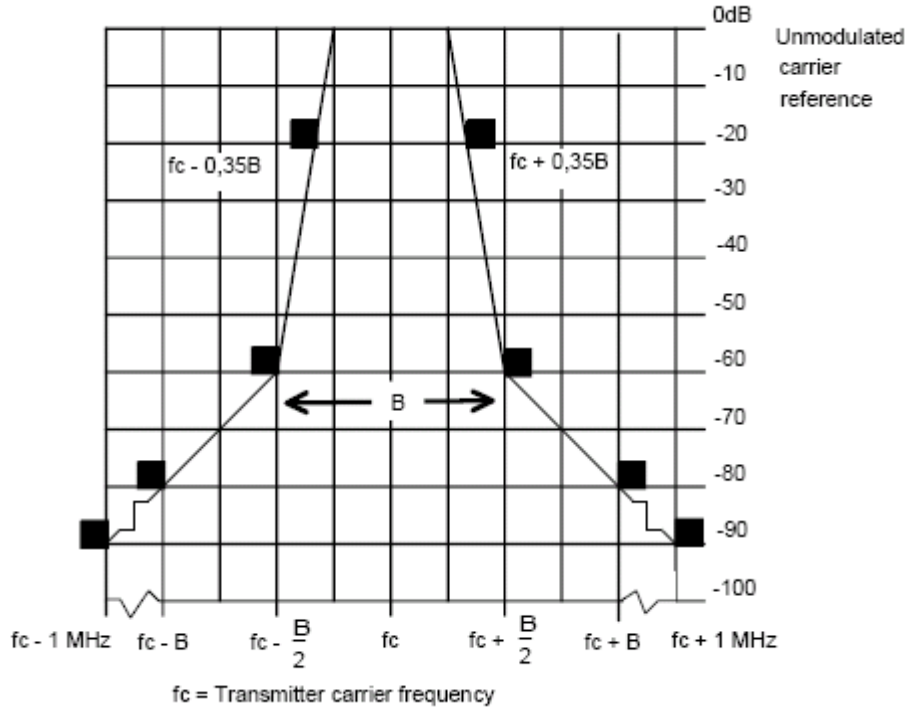

#### Standard Applicable

According to §15.236 (g) Emissions within the band from one megahertz below to one megahertz above the carrier frequency shall comply with the emission mask in §8.3 of ETSI EN 300 422-1 V1.4.2 (2011-08), Electromagnetic compatibility and Radio spectrum Matters (ERM); DSLR Wireless Microphones in the 25 MHz to 3GHz frequency range; Part 1: Technical characteristics and methods of measurement. Emissions outside of this band shall comply with the limits specified in section 8.4 of ETSI EN 300 422-1 V1.4.2 (2011-08).

According to ETSI EN 300 422-2 V2.1.1 section 8.3, the transmitter output spectrum shall be within the mask defined in the following figure.

#### TEST CONFIGURATION

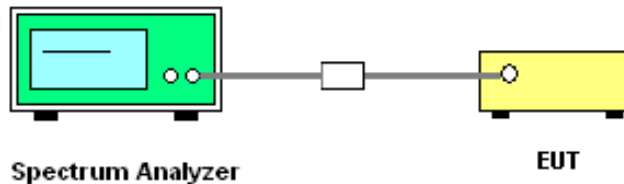

**Test Procedure:**

The arrangement of test equipment as shown in figure B.1 shall be used. Note that the noise meter conforms to (quasi peak) without weighting filter (flat).

With the Low Frequency (LF) audio signal generator set to 500 Hz, the audio input level to the DUT shall be adjusted to 8 dB below the limiting threshold (-8 dB (lim)) as declared by the manufacturer.

The corresponding audio output level from the demodulator shall be measured and recorded.

The input impedance of the noise meter shall be sufficiently high to avoid more than 0,1 dB change in input level when the meter is switched between input and output.

The audio input level shall be increased by 20 dB, i.e. to +12 dB (lim), and the corresponding change in output level shall be measured.

It shall be checked that the audio output level has increased by  $\leq 10$  dB.

If this condition is not met, the initial audio input level shall be increased from -8 dB (lim) in 1 dB steps until the above condition is fulfilled, and the input level recorded in the test report. This level replaces the value derived from the manufacturer's declaration and is defined as -8 dB (lim).

Measure the input level at the transmitter required to give +12 dB (lim).

The LF generator shall be replaced with the weighted noise source to Recommendation ITU-R BS.559-2 [i.3], band-limited to 15 kHz as described in IEC 60244-13 [2], and the level shall be adjusted such that the measured input to the transmitter corresponds to +12 dB (lim).

If the transmitter incorporates any ancillary coding or signalling channels (e.g. pilot-tones), these shall be enabled prior to any spectral measurements.

If the transmitter incorporates more than one audio input, e.g. stereo systems, the second and subsequent channels shall be simultaneously driven from the same noise source, attenuated to a level of -6 dB (lim).

- centre frequency:  $f_c$ : Transmitter (Tx) nominal frequency;
- dispersion (Span):  $f_c - 1$  MHz to  $f_c + 1$  MHz;
- Resolution BandWidth (RBW): 1 kHz;
- Video BandWidth (VBW): 1 kHz;
- detector: Peak hold.



Test Result

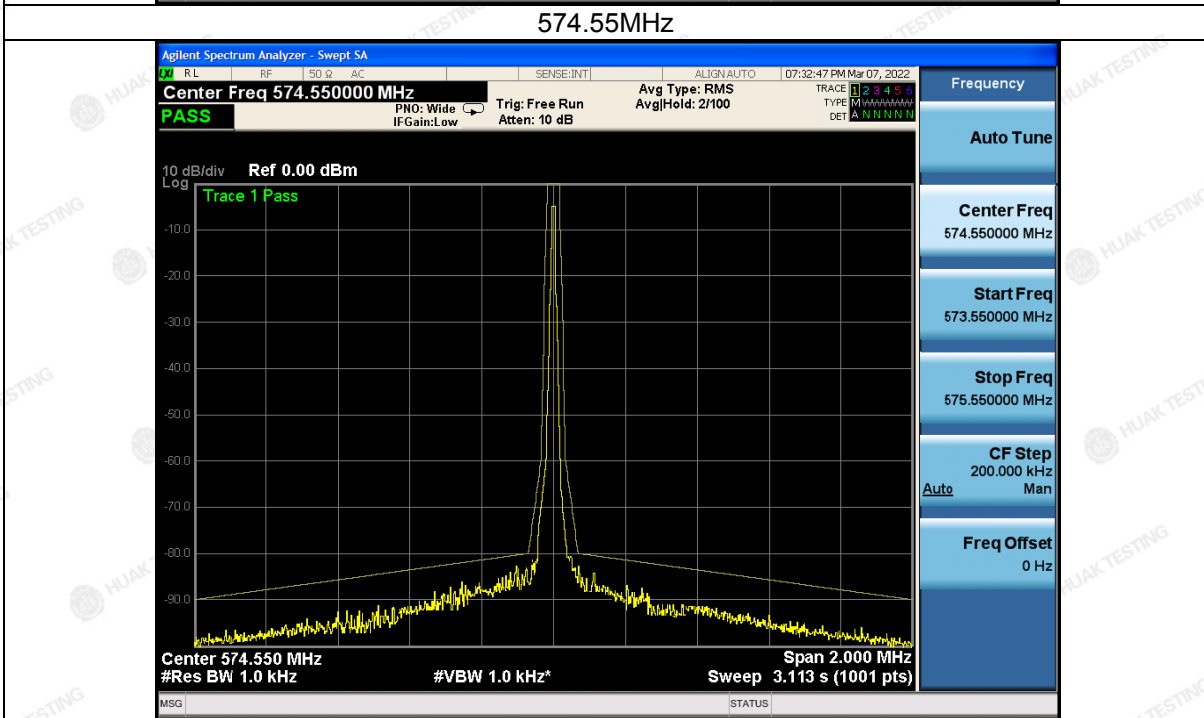
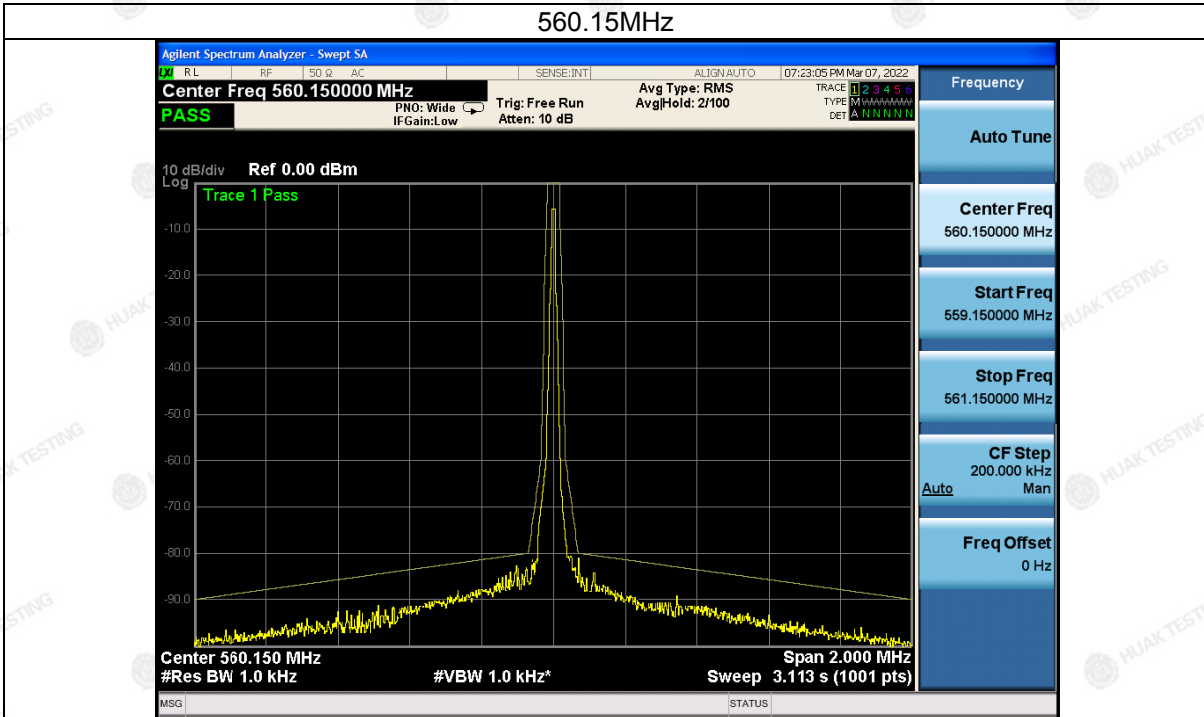

The results shown in this test report refer only to the sample(s) tested unless otherwise stated and the sample(s) are retained for 30 days only. The document is issued by HUAK, this document cannot be reproduced except in full with our prior written permission. The more details and the authenticity of the report will be confirmed at <http://www.cer-mark.com>.

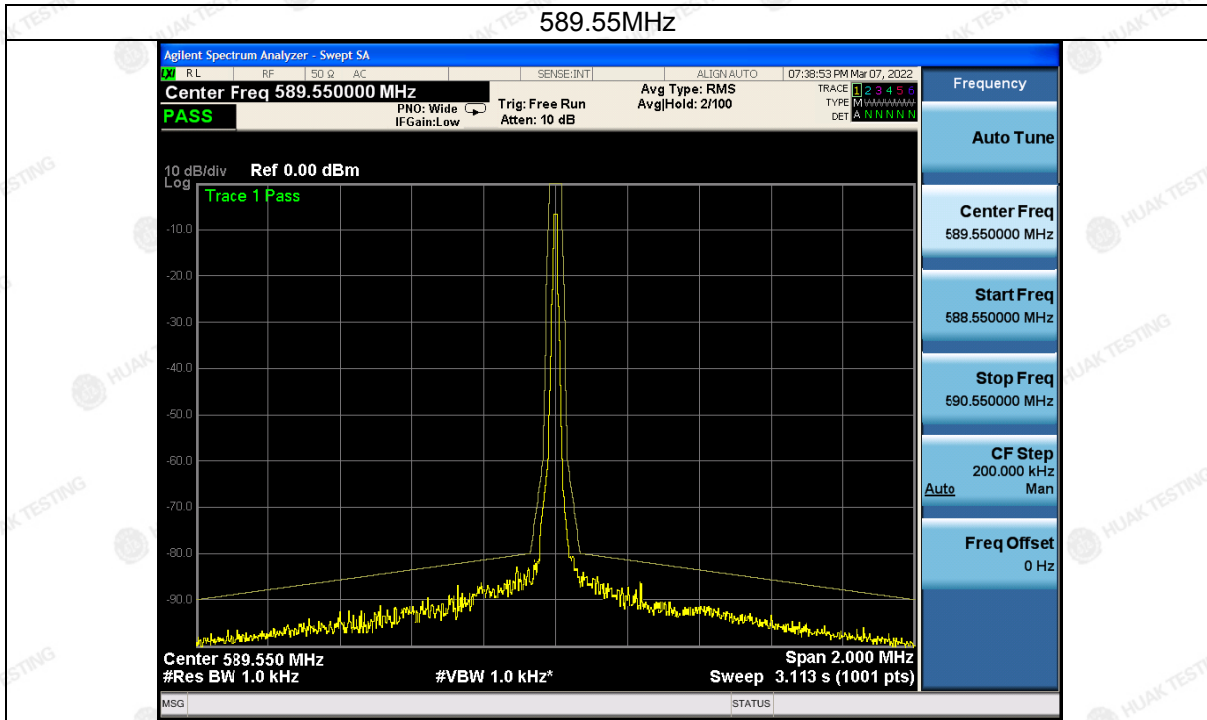

The results shown in this test report refer only to the sample(s) tested unless otherwise stated and the sample(s) are retained for 30 days only. The document is issued by HUAK, this document cannot be reproduced except in full with our prior written permission. The more details and the authenticity of the report will be confirmed at <http://www.cer-mark.com>.

HUAK Testing Lab TEL : +86-755 2302 9901 FAX : +86-755 2302 9901 E-mail : [service@cer-mark.com](mailto:service@cer-mark.com)

1-2/F., Building B2, Junfeng Zhongcheng Zhizao Innovation Park, Heping, Fuhai Street, Bao'an District, Shenzhen, Guangdong, China



### 3.6 FREQUENCY STABILITY

**Limit**

±50ppm

**Standard Applicable**

According to FCC 15.236(f)(3), The frequency tolerance of the carrier signal shall be maintained within ±0.005% of the operating frequency over a temperature variation of -20 degrees to +50 degrees C at normal supply voltage, and for a variation in the primary supply voltage from 85% to 115% of the rated supply voltage at a temperature of 20 degrees C. Battery operated equipment shall be tested using a new battery.

**TEST CONFIGURATION**

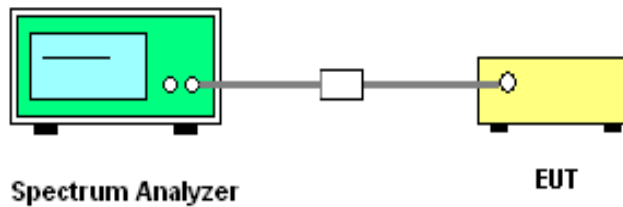

**Test Procedure:**

1. Setup the configuration of the ambient temperature from -20°C to 50°C with sufficient time. And measure the different power of the EUT with an artificial power from highest to end point voltage.
2. Set frequency counter center frequency to the right frequency needs to be measured band.

**Test Result**

Test frequency (MHz)	Test Conditions		Measure Frequency (MHz)	Frequency Error		Limit ppm	Result
	Voltage (V)	Temperature (°C)		(MHz)	ppm		
560.15MHz	N	N	560.1477	-0.0023	-4.11	±50ppm	PASS
		L	560.1463	-0.0037	-6.61		
		H	560.1461	-0.0039	-6.96		
	L	N	560.1404	-0.0096	-17.14		
		L	560.1411	-0.0089	-15.89		
		H	560.1433	-0.0067	-11.96		
	H	N	560.1410	-0.009	-16.07		
		L	560.1443	-0.0057	-10.18		
		H	560.1427	-0.0073	-13.03		

The results shown in this test report refer only to the sample(s) tested unless otherwise stated and the sample(s) are retained for 30 days only. The document is issued by HUAKE, this document cannot be reproduced except in full with our prior written permission. The more details and the authenticity of the report will be confirmed at <http://www.cer-mark.com>.



Test frequency (MHz)	Test Conditions		Measure Frequency (MHz)	Frequency Error		Limit ppm	Result
	Voltage (V)	Temperature (°C)		(MHz)	ppm		
574.55MHz	N	N	574.5486	-0.0014	-2.44	± 50ppm	PASS
		L	574.5491	-0.0009	-1.57		
		H	574.5463	-0.0037	-6.44		
	L	N	574.5497	-0.0003	-0.52		
		L	574.5493	-0.0007	-1.22		
		H	574.5418	-0.0082	-14.27		
	H	N	574.5497	-0.0003	-0.52		
		L	574.5454	-0.0046	-8.01		
		H	574.5498	-0.0002	-0.35		
589.55MHz	N	N	589.5454	-0.0046	-7.80	± 50ppm	PASS
		L	589.5401	-0.0099	-16.79		
		H	589.5448	-0.0052	-8.82		
	L	N	589.5469	-0.0031	-5.26		
		L	589.5434	-0.0066	-11.20		
		H	589.5465	-0.0035	-5.94		
	H	N	589.5429	-0.0071	-12.04		
		L	589.5471	-0.0029	-4.92		
		H	589.5420	-0.008	-13.57		

The results shown in this test report refer only to the sample(s) tested unless otherwise stated and the sample(s) are retained for 30 days only. The document is issued by HUAK, this document cannot be reproduced except in full with our prior written permission. The more details and the authenticity of the report will be confirmed at <http://www.cer-mark.com>.



### 3.7 ANTENNA REQUIREMENT

#### Standard Applicable

For intentional device, according to FCC 47 CFR Section 15.203, an intentional radiator shall be designed to ensure that no antenna other than that furnished by the responsible party shall be used with the device.

#### Refer to statement below for compliance.

The manufacturer may design the unit so that the user can replace a broken antenna, but the use of a standard antenna jack or electrical connector is prohibited. Further, this requirement does not apply to intentional radiators that must be professionally installed.

#### Antenna Connected Construction

The antenna used in this product is an internal Antenna, need professional installation. It conforms to the standard requirements. The directional gains of antenna used for transmitting is 1dBi.

#### ANTENNA

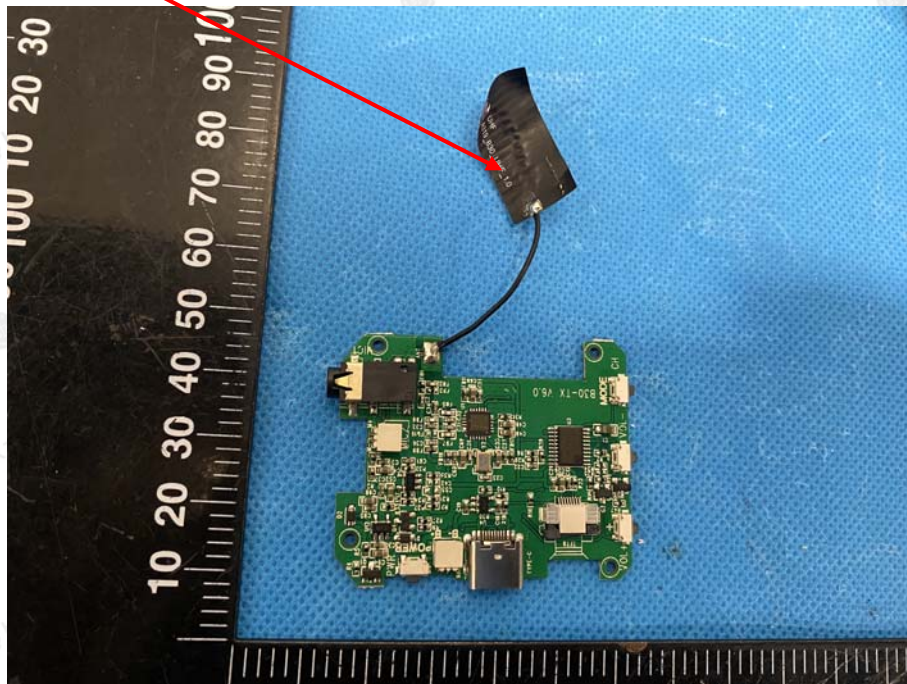





## 4 PHOTOGRAPH OF TEST

### Radiated Emission

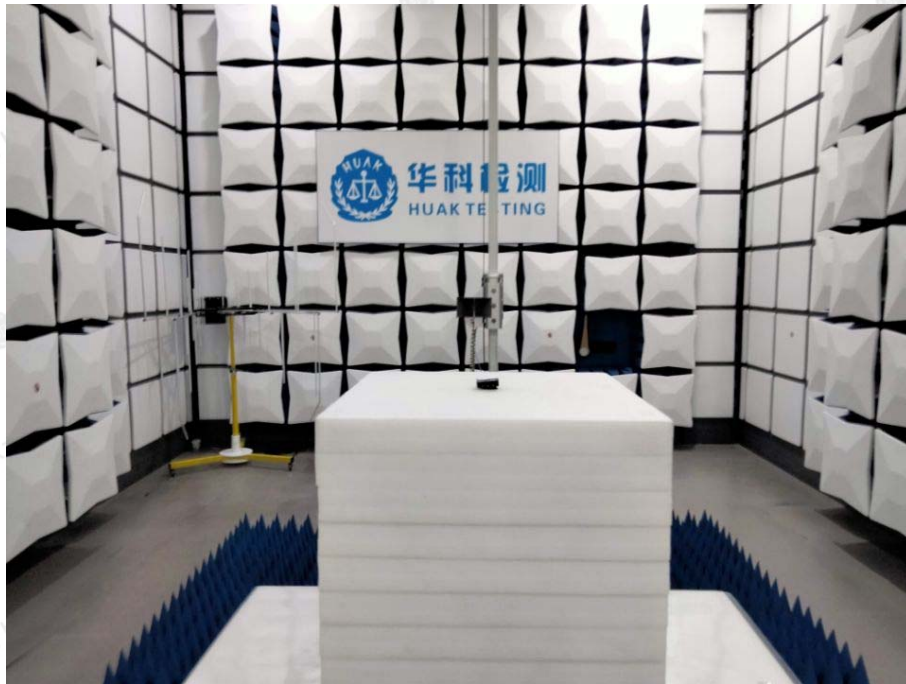
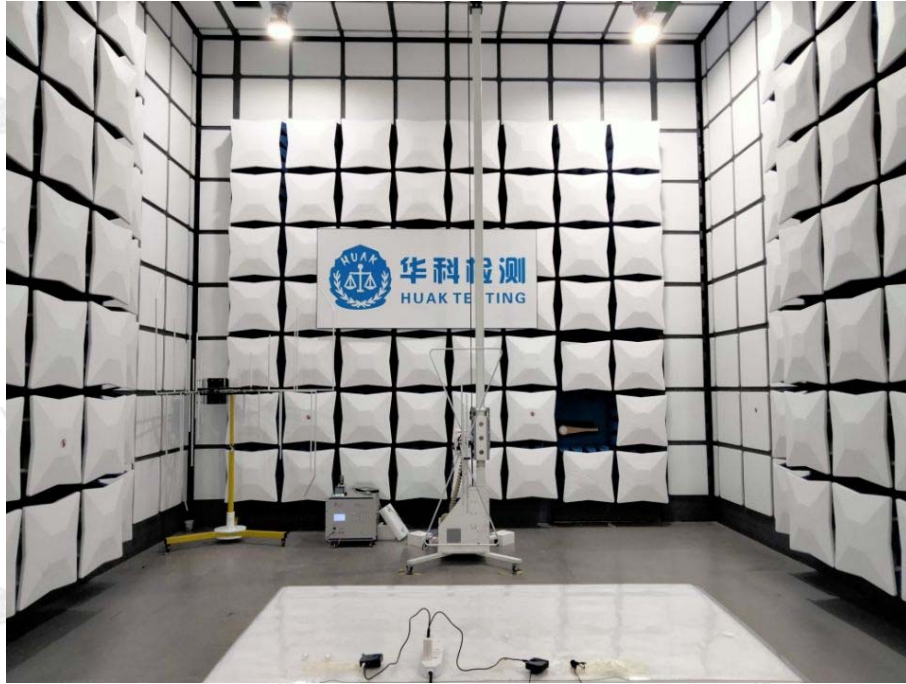

The results shown in this test report refer only to the sample(s) tested unless otherwise stated and the sample(s) are retained for 30 days only. The document is issued by HUAK, this document cannot be reproduced except in full with our prior written permission. The more details and the authenticity of the report will be confirmed at <http://www.cer-mark.com>.

HUAK Testing Lab TEL : +86-755 2302 9901 FAX : +86-755 2302 9901 E-mail : [service@cer-mark.com](mailto:service@cer-mark.com)

1-2/F., Building B2, Junfeng Zhongcheng Zhizao Innovation Park, Heping, Fuhai Street, Bao'an District, Shenzhen, Guangdong, China





### Conducted Emission

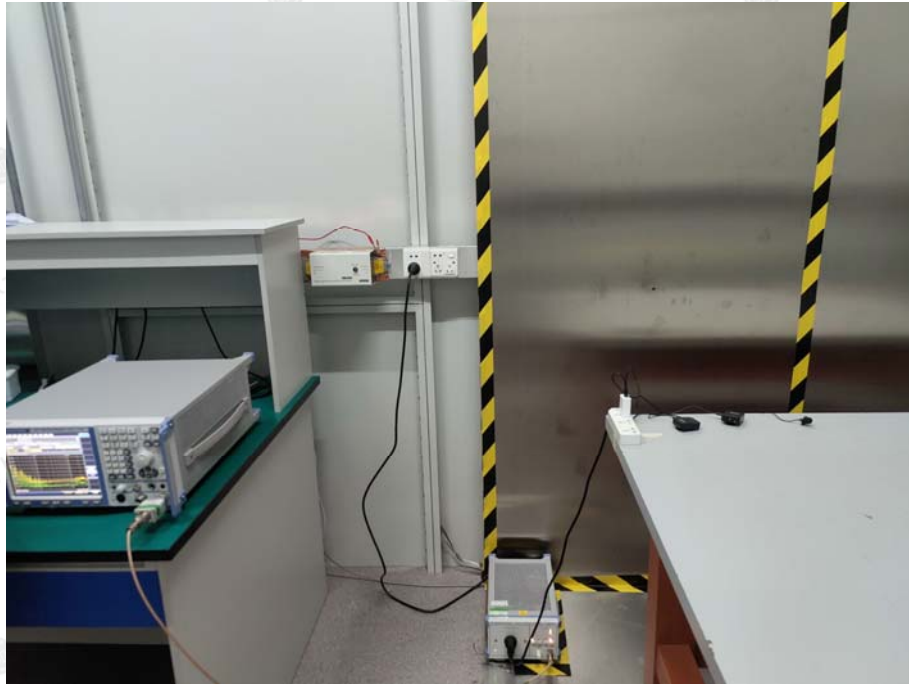

The results shown in this test report refer only to the sample(s) tested unless otherwise stated and the sample(s) are retained for 30 days only. The document is issued by HUAK, this document cannot be reproduced except in full with our prior written permission. The more details and the authenticity of the report will be confirmed at <http://www.cer-mark.com>.

**HUAK Testing Lab** TEL : +86-755 2302 9901 FAX : +86-755 2302 9901 E-mail : [service@cer-mark.com](mailto:service@cer-mark.com)

1-2/F., Building B2, Junfeng Zhongcheng Zhizao Innovation Park, Heping, Fuhai Street, Bao'an District, Shenzhen, Guangdong, China



## 5 PHOTOGRAPH OF EUT

Reference to the report: ANNEX A of external photos and ANNEX B of internal photos

-----End of test report-----