



# TEST REPORT

## FCC PART 15 SUBPART C

**Report Reference No.:** CTL1905091031-WF

Compiled by: Happy Guo  
( position+printed name+signature) (File administrators)

*Happy Guo*

Tested by: Nice Nong  
( position+printed name+signature) (Test Engineer)

*NICE NONG*

Approved by: Ivan Xie  
( position+printed name+signature) (Manager)

*Ivan Xie*

**Product Name**.....: Wireless Charging Power Bank

**Model/Type reference** .....: CHARGEit

**List Model(s)**.....: N/A

**Trade Mark** .....: SACKit

**FCC ID** .....: 2AO5W-CHARGEIT

**Applicant's name** .....: **SACKit ApS**

**Address of applicant** .....: Lyngvej 1, DK-9000 Aalbrog, Denmark

**Test Firm** .....: **Shenzhen CTL Testing Technology Co., Ltd.**

**Address of Test Firm** .....: Floor 1-A, Baisha Technology Park, No.3011, Shahexi Road, Nanshan District, Shenzhen, China 518055

**Test specification**.....:

Standard.....: **FCC Rules Part 15.207,15.209, 15.215(c)**  
**ANSI C63.10-2013**

TRF Originator .....: Shenzhen CTL Testing Technology Co., Ltd.

Master TRF .....: Dated 2011-01

**Date of Receipt**.....: May 17, 2019

**Date of sampling** .....: May 17, 2019

**Date of Test Date**.....: May 17, 2019–May 21, 2019

**Data of Issue**.....: May 30, 2019

**Result**.....: Pass

**Shenzhen CTL Testing Technology Co., Ltd. All rights reserved.**

This publication may be reproduced in whole or in part for non-commercial purposes as long as the Shenzhen CTL Testing Technology Co., Ltd. is acknowledged as copyright owner and source of the material. Shenzhen CTL Testing Technology Co., Ltd. takes no responsibility for and will not assume liability for damages resulting from the reader's interpretation of the reproduced material due to its placement and context.

# TEST REPORT

|   |                               |
|---|-------------------------------|
| <b>Test Report No. :</b> CTL1905091031-WF | May 30, 2019<br>Date of issue |
|---|-------------------------------|

Equipment under Test : Wireless Charging Power Bank

Model /Type : CHARGEit

Listed Models : N/A

**Applicant** : **SACKit ApS**

Address : Lyngvej 1, DK-9000 Aalbrog, Denmark

**Manufacturer** : **Shenzhen Powerqi Technology Co., Ltd.**

Address : 2nd Floor, A4 Building, Block A, Fangxing Science & Tech. Park, Longgang District, Shenzhen, China

|                    |               |
|--------------------|---------------|
| <b>Test result</b> | <b>Pass *</b> |
|--------------------|---------------|

\*In the configuration tested, the EUT complied with the standards specified page 5.

The test results presented in this report relate only to the object tested.

This report shall not be reproduced, except in full, without the written approval of the issuing testing laboratory.



**Table of Contents**

**Page**

|  |           |
|--|-----------|
| <b>1. SUMMARY.....</b>                             | <b>5</b>  |
| 1.1. TEST STANDARDS.....                           | 5         |
| 1.2. TEST DESCRIPTION.....                         | 5         |
| 1.3. TEST FACILITY.....                            | 6         |
| 1.4. STATEMENT OF THE MEASUREMENT UNCERTAINTY..... | 6         |
| <b>2. GENERAL INFORMATION.....</b>                 | <b>8</b>  |
| 2.1. ENVIRONMENTAL CONDITIONS.....                 | 8         |
| 2.2. GENERAL DESCRIPTION OF EUT.....               | 8         |
| 2.3. SPECIAL ACCESSORIES.....                      | 8         |
| 2.4. EQUIPMENTS USED DURING THE TEST.....          | 8         |
| 2.5. RELATED SUBMITTAL(S) / GRANT (S).....         | 9         |
| 2.6. MODIFICATIONS.....                            | 9         |
| <b>3. TEST CONDITIONS AND RESULTS.....</b>         | <b>10</b> |
| 3.1. CONDUCTED EMISSIONS TEST.....                 | 10        |
| 3.2. RADIATED EMISSIONS.....                       | 13        |
| 3.3. 20dB BANDWIDTH.....                           | 16        |
| <b>4. TEST SETUP PHOTOS OF THE EUT.....</b>        | <b>17</b> |
| <b>5. PHOTOS OF THE EUT.....</b>                   | <b>18</b> |

# 1. SUMMARY

## 1.1. TEST STANDARDS

The tests were performed according to following standards:

[FCC Rules Part 15.207, 15.209, 15.215\(c\)](#)

[ANSI C63.10: 2013](#): American National Standard for Testing Unlicensed Wireless Devices

## 1.2. Test Description

| Test Item                         | Test Standards                   | Test Result |
|-----------------------------------|----------------------------------|-------------|
| Electric Field Radiated Emissions | FCC Part 15 C (Section15.209)    | PASS        |
| 20dB Bandwidth/99% Bandwidth      | FCC Part 15 C (Section15.215(c)) | PASS        |
| Conducted Emissions               | FCC Part 15 C (Section15.207)    | PASS        |

## 1.3. Test Facility

### 1.3.1 Address of the test laboratory

Shenzhen CTL Testing Technology Co., Ltd.

Floor 1-A, Baisha Technology Park, No. 3011, Shahexi Road, Nanshan, Shenzhen 518055 China

There is one 3m semi-anechoic chamber and two line conducted labs for final test. The Test Sites meet the requirements in documents ANSI C63.4 and CISPR 32/EN 55032 requirements.

### 1.3.2 Laboratory accreditation

The test facility is recognized, certified, or accredited by the following organizations:

#### CNAS-Lab Code: L7497

Shenzhen CTL Testing Technology Co., Ltd. has been assessed and proved to be in compliance with CNAS-CL01 Accreditation Criteria for Testing and Calibration Laboratories (identical to ISO/IEC 17025: 2005 General Requirements) for the Competence of Testing and Calibration Laboratories.

#### A2LA-Lab Cert. No. 4343.01

Shenzhen CTL Testing Technology Co., Ltd. EMC Laboratory has been accredited by A2LA for technical competence in the field of electrical testing, and proved to be in compliance with ISO/IEC 17025: 2005 General Requirements for the Competence of Testing and Calibration Laboratories and any additional program requirements in the identified field of testing.

#### IC Registration No.: 9518B

#### CAB identifier: CN0041

The 3m alternate test site of Shenzhen CTL Testing Technology Co., Ltd. EMC Laboratory has been registered by Innovation, Science and Economic Development Canada to test to Canadian radio equipment requirements with Registration No.: 9518B on Jan. 22, 2019.

#### FCC-Registration No.: 399832

#### Designation No.: CN1216

Shenzhen CTL Testing Technology Co., Ltd. EMC Laboratory has been registered and fully described in a report filed with the (FCC) Federal Communications Commission. The acceptance letter from the FCC is maintained in our files. Registration 399832, December 08, 2017.

## 1.4. Statement of the measurement uncertainty

The data and results referenced in this document are true and accurate. The reader is cautioned that there may be errors within the calibration limits of the equipment and facilities. The measurement uncertainty was calculated for all measurements listed in this test report acc. to CISPR 16 - 4 "Specification for radio disturbance and immunity measuring apparatus and methods – Part 4: Uncertainty in EMC Measurements" and is documented in the Shenzhen CTL Testing Technology Co., Ltd. quality system acc. to DIN EN ISO/IEC 17025. Furthermore, component and process variability of devices similar to that tested may result in additional deviation. The manufacturer has the sole responsibility of continued compliance of the device.

Hereafter the best measurement capability for CTL laboratory is reported:

| Test                                    | Measurement Uncertainty | Notes |
|---|-------------------------|-------|
| Transmitter power conducted             | ±0.57 dB                | (1)   |
| Transmitter power Radiated              | ±2.20 dB                | (1)   |
| Conducted spurious emission 9KHz-40 GHz | ±2.20 dB                | (1)   |
| Occupied Bandwidth                      | ±0.01ppm                | (1)   |
| Radiated Emission 30~1000MHz            | ±4.10dB                 | (1)   |
| Radiated Emission Above 1GHz            | ±4.32dB                 | (1)   |

|                                  |                     |     |
|----------------------------------|---------------------|-----|
| Conducted Disturbance 0.15~30MHz | $\pm 3.20\text{dB}$ | (1) |
|----------------------------------|---------------------|-----|

(1) This uncertainty represents an expanded uncertainty expressed at approximately the 95% confidence level using a coverage factor of  $k=2$ .

## 2. GENERAL INFORMATION

### 2.1. Environmental conditions

During the measurement the environmental conditions were within the listed ranges:

|                     |         |
|---------------------|---------|
| Normal Temperature: | 25°C    |
| Relative Humidity:  | 55 %    |
| Air Pressure:       | 101 kPa |

### 2.2. General Description of EUT

|                       |                                |
|-----------------------|--------------------------------|
| Product Name:         | Wireless Charging Power Bank   |
| Model/Type reference: | CHARGEit                       |
| Battery capacity:     | 6000mAh(TYP)/3.7V, 22.2Wh(TYP) |
| Input :               | USB-C 5V/2A, 9V/1.67A          |
| Output:               | USB-A 5V/2.1A                  |
| Operation frequency:  | 115KHz~205KHz                  |
| Antenna type:         | Loop antenna                   |
| Antenna gain:         | 0dBi                           |

Note: For more details, please refer to the user's manual of the EUT.

### 2.3. Special Accessories

| Manufacturer | Description | Model     | Serial Number  |
|--------------|-------------|-----------|----------------|
| ASUS         | Notebook PC | FL5900U   | 9014           |
| Samsung      | Phone       | Galaxy s7 | 35615607721414 |

### 2.4. Equipments Used during the Test

| Test Equipment      | Manufacturer         | Model No.          | Serial No.   | Calibration Date recent | Calibration Due Date |
|---------------------|----------------------|--------------------|--------------|-------------------------|----------------------|
| LISN                | R&S                  | ENV216             | 3560.6550.12 | 2018/05/25              | 2019/05/24           |
| LISN                | R&S                  | ESH2-Z5            | 860014/010   | 2018/05/25              | 2019/05/24           |
| Power Meter         | Agilent              | U2531A             | TW53323507   | 2018/05/25              | 2019/05/24           |
| Power Sensor        | Agilent              | U2021XA            | MY5365004    | 2018/05/25              | 2019/05/24           |
| EMI Test Receiver   | R&S                  | ESCI               | 103710       | 2018/05/25              | 2019/05/24           |
| Spectrum Analyzer   | Agilent              | E4407B             | MY41440676   | 2018/05/25              | 2019/05/24           |
| Spectrum Analyzer   | Agilent              | N9020              | US46220290   | 2018/05/25              | 2019/05/24           |
| Controller          | EM Electronics       | Controller EM 1000 | N/A          | 2018/05/25              | 2019/05/24           |
| Active Loop Antenna | Daze                 | ZN30900A           | N/A          | 2018/05/25              | 2019/05/24           |
| Bilog Antenna       | Schwarzbeck          | VULB 9168          | 00824        | 2018/05/25              | 2019/05/24           |
| Horn Antenna        | Sunol Sciences Corp. | DRH-118            | A062013      | 2018/05/25              | 2019/05/24           |
| Horn Antenna        | SCHWARZBACK          | BBHA 9170          | BBHA9170184  | 2018/05/25              | 2019/05/24           |
| Amplifier           | Agilent              | 8349B              | 3008A02306   | 2018/05/25              | 2019/05/24           |
| Amplifier           | Agilent              | 8447D              | 2944A10176   | 2018/05/25              | 2019/05/24           |



|                            |              |                        |        |            |            |
|----------------------------|--------------|------------------------|--------|------------|------------|
| Temperature/Humidity Meter | Gangxing     | CTH-608                | 02     | 2018/05/25 | 2019/05/24 |
| High-Pass Filter           | K&L          | 9SH10-2700/X12750-O/O  | N/A    | 2018/05/25 | 2019/05/24 |
| High-Pass Filter           | K&L          | 41H10-1375/U12750-O/O  | N/A    | 2018/05/25 | 2019/05/24 |
| Coaxial Cables             | HUBER+SUHNER | SUCOFLEX<br>104PEA-10M | 10m    | 2018/05/25 | 2019/05/24 |
| Coaxial Cables             | HUBER+SUHNER | SUCOFLEX 104PEA-3M     | 3m     | 2018/05/25 | 2019/05/24 |
| Coaxial Cables             | HUBER+SUHNER | SUCOFLEX 104PEA-3M     | 3m     | 2018/05/25 | 2019/05/24 |
| RF Cable                   | Megalon      | RF-A303                | N/A    | 2018/05/25 | 2019/05/24 |
| EMI Test Software          | R&S          | ES-K1                  | V1.7.1 | 2018/05/25 | 2019/05/24 |
| EMI Test Software          | AUDIX        | E3                     | V6.0   | 2018/05/25 | 2019/05/24 |

The calibration interval was one year

## 2.5. Related Submittal(s) / Grant (s)

This submittal(s) (test report) is intended to comply with FCC Part 15, Subpart C Rules.

## 2.6. Modifications

No modifications were implemented to meet testing criteria.

### 3. TEST CONDITIONS AND RESULTS

#### 3.1. Conducted Emissions Test

##### LIMIT

FCC CFR Title 47 Part 15 Subpart C Section 15.207

| Frequency range (MHz) | Limit (dBuV) |           |
|-----------------------|--------------|-----------|
|                       | Quasi-peak   | Average   |
| 0.15-0.5              | 66 to 56*    | 56 to 46* |
| 0.5-5                 | 56           | 46        |
| 5-30                  | 60           | 50        |

\* Decreases with the logarithm of the frequency.

##### TEST CONFIGURATION



##### TEST PROCEDURE

1. The equipment was set up as per the test configuration to simulate typical actual usage per the user's manual. The EUT is a tabletop system; a wooden table with a height of 0.8 meters is used and is placed on the ground plane as per ANSI C63.10:2013.
2. Support equipment, if needed, was placed as per ANSI C63.10:2013.
3. All I/O cables were positioned to simulate typical actual usage as per ANSI C63.10:2013.
4. The adapter received AC120V/60Hz power through a Line Impedance Stabilization Network (LISN) which supplied power source and was grounded to the ground plane.
5. All support equipments received AC power from a second LISN, if any.
6. The EUT test program was started. Emissions were measured on each current carrying line of the EUT using a spectrum Analyzer / Receiver connected to the LISN powering the EUT. The LISN has two monitoring points: Line 1 (Hot Side) and Line 2 (Neutral Side). Two scans were taken: one with Line 1 connected to Analyzer / Receiver and Line 2 connected to a 50 ohm load; the second scan had Line 1 connected to a 50 ohm load and Line 2 connected to the Analyzer / Receiver.
7. Analyzer / Receiver scanned from 150 KHz to 30MHz for emissions in each of the test modes.
8. During the above scans, the emissions were maximized by cable manipulation.

**TEST RESULTS**

Note: Both power supply modes have been tested, and the following data are the worst

**SCAN TABLE: "Voltage (9K-30M) FIN"**

Short Description: 150K-30M Voltage

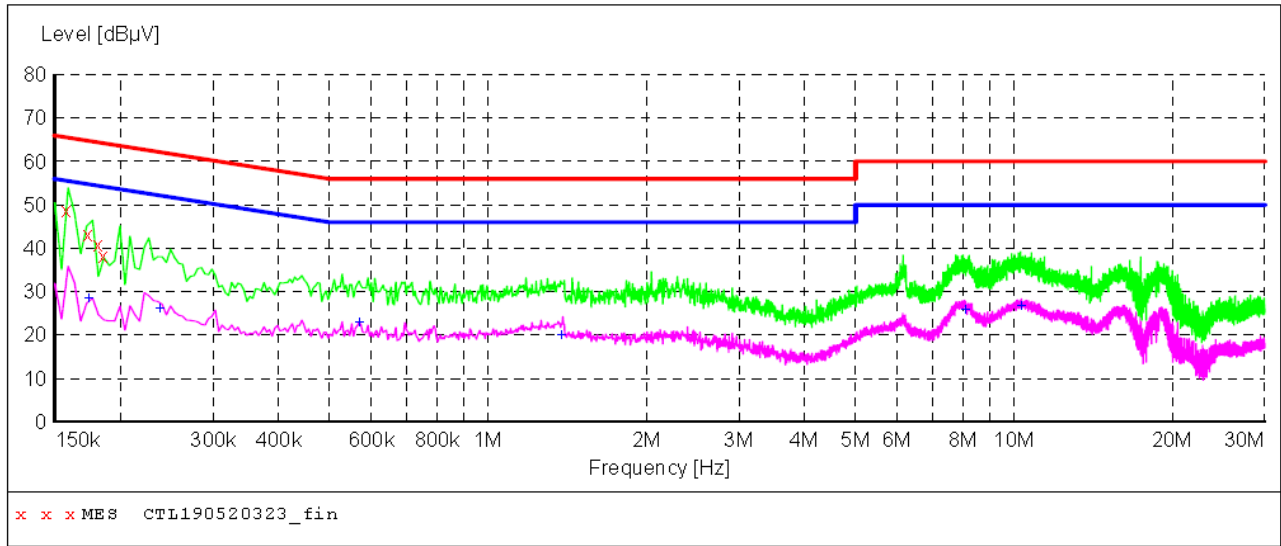

**MEASUREMENT RESULT: "CTL190520323\_fin"**

2019-5-20 05:10??

| Frequency MHz | Level dBµV | Transd dB | Limit dBµV | Margin dB | Detector | Line | PE  |
|---------------|------------|-----------|------------|-----------|----------|------|-----|
| 0.158000      | 48.70      | 11.2      | 66         | 16.9      | QP       | L1   | GND |
| 0.174000      | 43.20      | 11.2      | 65         | 21.6      | QP       | L1   | GND |
| 0.182000      | 41.00      | 11.2      | 64         | 23.4      | QP       | L1   | GND |
| 0.186000      | 38.30      | 11.2      | 64         | 25.9      | QP       | L1   | GND |

**MEASUREMENT RESULT: "CTL190520323\_fin2"**

2019-5-20 05:10??

| Frequency MHz | Level dBµV | Transd dB | Limit dBµV | Margin dB | Detector | Line | PE  |
|---------------|------------|-----------|------------|-----------|----------|------|-----|
| 0.174000      | 28.50      | 11.2      | 55         | 26.3      | AV       | L1   | GND |
| 0.238000      | 26.30      | 11.2      | 52         | 25.9      | AV       | L1   | GND |
| 0.572000      | 23.10      | 11.2      | 46         | 22.9      | AV       | L1   | GND |
| 1.382000      | 20.10      | 11.3      | 46         | 25.9      | AV       | L1   | GND |
| 8.090000      | 26.10      | 11.0      | 50         | 23.9      | AV       | L1   | GND |
| 10.328000     | 27.00      | 11.1      | 50         | 23.0      | AV       | L1   | GND |

**SCAN TABLE: "Voltage (9K-30M) FIN"**

Short Description: 150K-30M Voltage

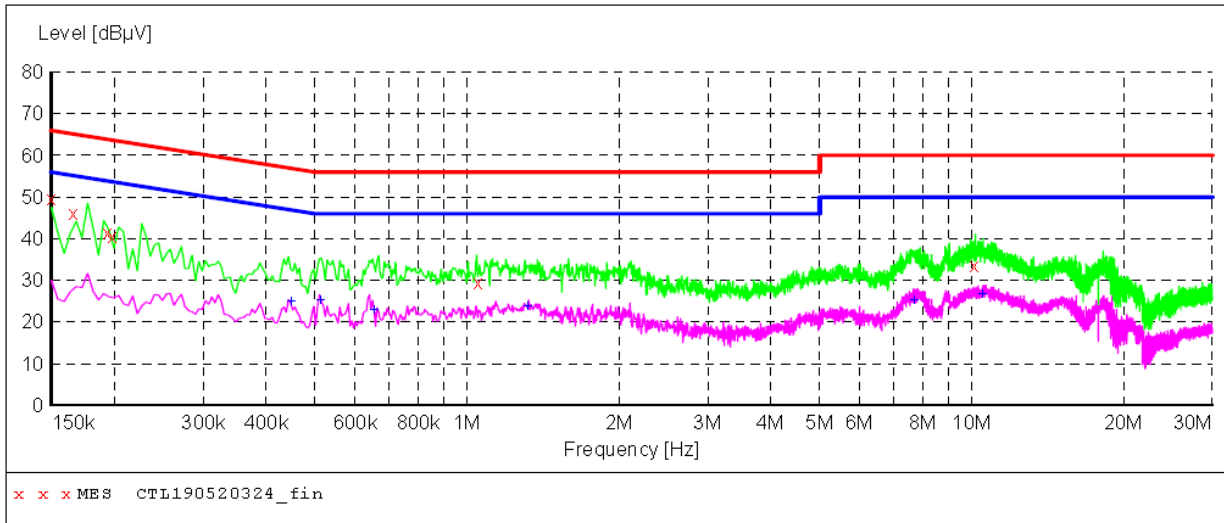

**MEASUREMENT RESULT: "CTL190520324\_fin"**

2019-5-20 05:13??

| Frequency<br>MHz | Level<br>dBµV | Transd<br>dB | Limit<br>dBµV | Margin<br>dB | Detector | Line | PE  |
|------------------|---------------|--------------|---------------|--------------|----------|------|-----|
| 0.150000         | 49.60         | 11.2         | 66            | 16.4         | QP       | N    | GND |
| 0.166000         | 46.20         | 11.2         | 65            | 19.0         | QP       | N    | GND |
| 0.194000         | 41.50         | 11.2         | 64            | 22.4         | QP       | N    | GND |
| 0.198000         | 40.70         | 11.2         | 64            | 23.0         | QP       | N    | GND |
| 1.052000         | 29.60         | 11.3         | 56            | 26.4         | QP       | N    | GND |
| 10.130000        | 33.70         | 11.1         | 60            | 26.3         | QP       | N    | GND |

**MEASUREMENT RESULT: "CTL190520324\_fin2"**

2019-5-20 05:13??

| Frequency<br>MHz | Level<br>dBµV | Transd<br>dB | Limit<br>dBµV | Margin<br>dB | Detector | Line | PE  |
|------------------|---------------|--------------|---------------|--------------|----------|------|-----|
| 0.450000         | 25.10         | 11.2         | 47            | 21.8         | AV       | N    | GND |
| 0.512000         | 25.50         | 11.2         | 46            | 20.5         | AV       | N    | GND |
| 0.656000         | 23.20         | 11.2         | 46            | 22.8         | AV       | N    | GND |
| 1.322000         | 23.90         | 11.3         | 46            | 22.1         | AV       | N    | GND |
| 7.718000         | 25.50         | 11.0         | 50            | 24.5         | AV       | N    | GND |
| 10.550000        | 27.00         | 11.1         | 50            | 23.0         | AV       | N    | GND |

### 3.2. Radiated Emissions

#### Limit

For intentional device, according to § 15.209(a), the general requirement of field strength of radiated emission out of authorized band shall not exceed the following table at a 3 meters measurement distance.

In addition, radiated emissions which fall in the restricted bands, as defined in §15.205(a), must also comply with the radiated emission limits specified in §15.209(a)

Radiated emission limits

| Frequency (MHz) | Distance (Meters) | Radiated (dBµV/m)                            | Radiated (µV/m)       |
|-----------------|-------------------|--|-----------------------|
| 0.009-0.49      | 3                 | $20\log(2400/F(\text{KHz})) + 40\log(300/3)$ | $2400/F(\text{KHz})$  |
| 0.49-1.705      | 3                 | $20\log(24000/F(\text{KHz})) + 40\log(30/3)$ | $24000/F(\text{KHz})$ |
| 1.705-30        | 3                 | $20\log(30) + 40\log(30/3)$                  | 30                    |
| 30-88           | 3                 | 40.0   | 100                   |
| 88-216          | 3                 | 43.5   | 150                   |
| 216-960         | 3                 | 46.0   | 200                   |
| Above 960       | 3                 | 54.0   | 500                   |

#### TEST CONFIGURATION

1. Radiated Emission Test Set-Up, Frequency Below 30MHz

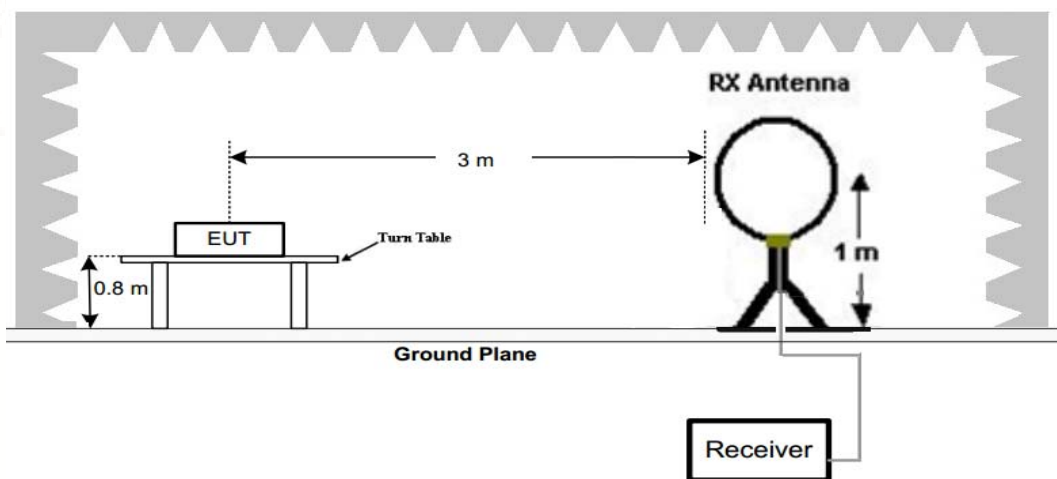

2. Radiated Emission Test Set-Up, Frequency below 1000MHz

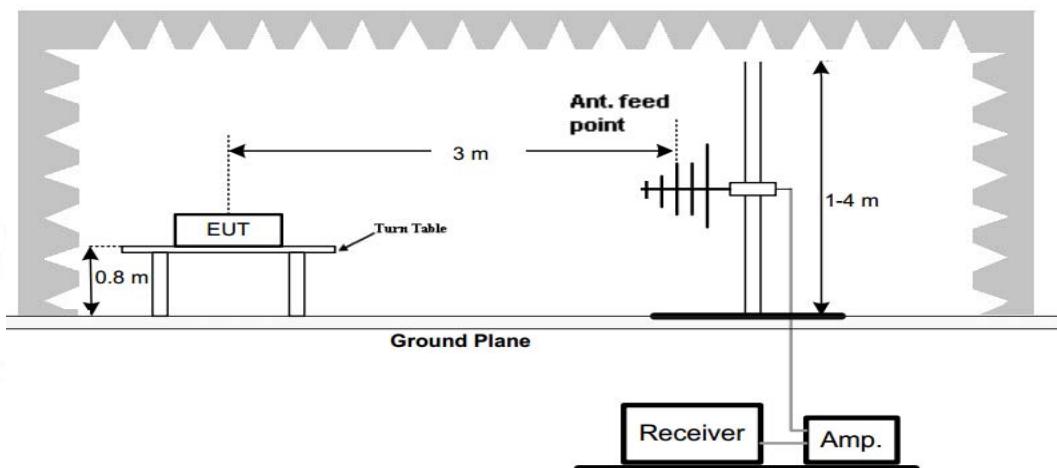

### Test Procedure

- Below 1GHz measurement the EUT is placed on a turntable which is 0.8m above ground plane, and above 1GHz measurement EUT was placed on a low permittivity and low loss tangent turn table which is 1.5m above ground plane.
- Maximum procedure was performed by raising the receiving antenna from 1m to 4m and rotating the turn table from 0°C to 360°C to acquire the highest emissions from EUT
- And also, each emission was to be maximized by changing the polarization of receiving antenna both horizontal and vertical.
- Repeat above procedures until all frequency measurements have been completed.
- Radiated emission test frequency band from 9KHz to 1000MHz.
- The distance between test antenna and EUT as following table states:

| Test Frequency range | Test Antenna Type   | Test Distance |
|----------------------|---------------------|---------------|
| 9KHz-30MHz           | Active Loop Antenna | 3             |
| 30MHz-1GHz           | Bilog Antenna       | 3             |

- Setting test receiver/spectrum as following table states:

| Test Frequency range | Test Receiver/Spectrum Setting         | Detector |
|----------------------|--|----------|
| 9KHz-150KHz          | RBW=200Hz/VBW=3KHz,Sweep time=Auto     | QP       |
| 150KHz-30MHz         | RBW=9KHz/VBW=100KHz,Sweep time=Auto    | QP       |
| 30MHz-1GHz           | RBW=120KHz/VBW=1000KHz,Sweep time=Auto | QP       |

### Test Results

#### WORST-CASE RADIATED EMISSION BELOW 30 MHz

| Frequency (MHz) | Reading (dB $\mu$ V/m) | Polar (Loop) | Antenna Factor (dB/m) | Cable Loss (dB) | Emission Levels (dB $\mu$ V/m) | Limits at 3m (dB $\mu$ V/m) | Margin (dB) | Detector Mode |
|-----------------|------------------------|--------------|-----------------------|-----------------|--------------------------------|-----------------------------|-------------|---------------|
| 0.122(F)        | 54.47                  | Loop         | 23.64                 | 0.01            | 78.12                          | 105.88                      | 27.76       | PK            |
| 0.122(F)        | 45.69                  | Loop         | 23.64                 | 0.01            | 69.34                          | 85.88                       | 16.54       | AV            |
| 0.110           | 36.72                  | Loop         | 23.55                 | 0.01            | 60.28                          | 106.78                      | 46.50       | PK            |
| 0.110           | 30.83                  | Loop         | 23.55                 | 0.01            | 54.39                          | 86.78                       | 32.39       | AV            |
| 0.495           | 25.26                  | Loop         | 25.07                 | -0.17           | 50.16                          | 73.71                       | 23.55       | QP            |
| 1.654           | 16.49                  | Loop         | 27.12                 | -0.25           | 43.36                          | 63.23                       | 19.87       | QP            |
| 2.418           | 17.05                  | Loop         | 23.91                 | -0.24           | 40.72                          | 69.54                       | 28.82       | QP            |
| --              | --                     | --           | --                    | --              | --                             | --                          | --          | --            |

Remark:

- Data of measurement within this frequency range shown "-- in the table above means the reading of emissions are attenuated more than 20dB below the permissible limits and not recorded.
- The test limit distance is 3m limit.
- PK means Peak Value, QP means Quasi Peak Value, AV means Average Value.
- F means Fundamental Frequency.
- Emission level (dB $\mu$ V/m) = Reading + Antenna Factor + Cable Loss.
- Margin value = Limit value- Emission level.

**For 30MHz-1GHz**

Note: Both power supply modes have been tested, and the following data are the worst

**Horizontal**

**SWEEP TABLE: "test (30M-1G)"**

| Short Description: |           | Field Strength |            |           |          | Transducer |
|--------------------|-----------|----------------|------------|-----------|----------|------------|
| Start              | Stop      | Detector       | Meas. Time | IF Bandw. |          |            |
| Frequency          | Frequency | MaxPeak        | 300.0 ms   | 120 kHz   | VULB9168 |            |

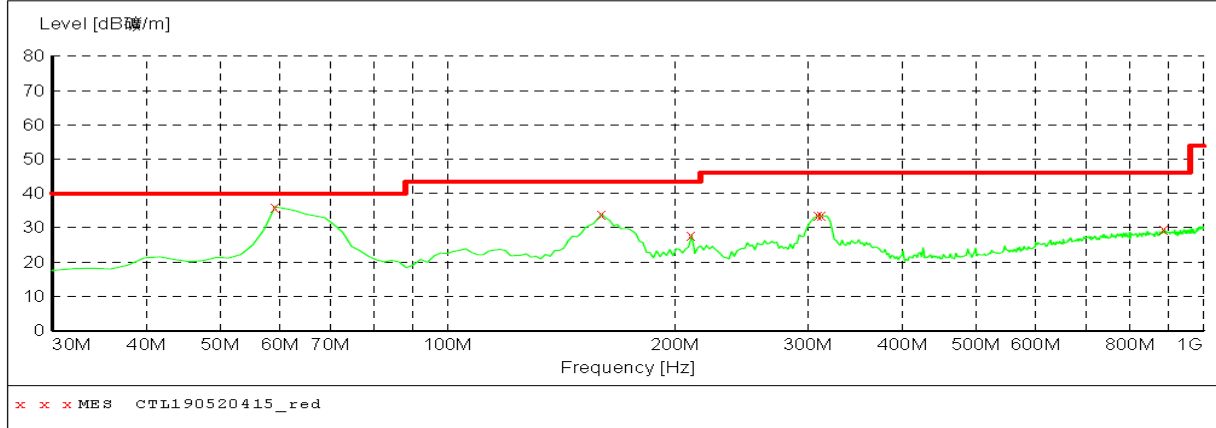

**MEASUREMENT RESULT: "CTL190520415\_red"**

2019-5-20 9:14

| Frequency MHz | Level dBμV/m | Transd dB | Limit dBμV/m | Margin dB | Det. | Height cm | Azimuth deg | Polarization |
|---------------|--------------|-----------|--------------|-----------|------|-----------|-------------|--------------|
| 59.100000     | 36.10        | 13.5      | 40.0         | 3.9       | QP   | 0.0       | 0.00        | HORIZONTAL   |
| 159.980000    | 33.90        | 15.2      | 43.5         | 9.6       | QP   | 0.0       | 0.00        | HORIZONTAL   |
| 210.420000    | 27.70        | 11.3      | 43.5         | 15.8      | QP   | 0.0       | 0.00        | HORIZONTAL   |
| 309.360000    | 33.60        | 14.4      | 46.0         | 12.4      | QP   | 0.0       | 0.00        | HORIZONTAL   |
| 313.240000    | 33.60        | 14.5      | 46.0         | 12.4      | QP   | 0.0       | 0.00        | HORIZONTAL   |
| 885.540000    | 29.50        | 23.5      | 46.0         | 16.5      | QP   | 0.0       | 0.00        | HORIZONTAL   |

**Vertical**

**SWEEP TABLE: "test (30M-1G)"**

| Short Description: |           | Field Strength |            |           |          | Transducer |
|--------------------|-----------|----------------|------------|-----------|----------|------------|
| Start              | Stop      | Detector       | Meas. Time | IF Bandw. |          |            |
| Frequency          | Frequency | MaxPeak        | 300.0 ms   | 120 kHz   | VULB9168 |            |

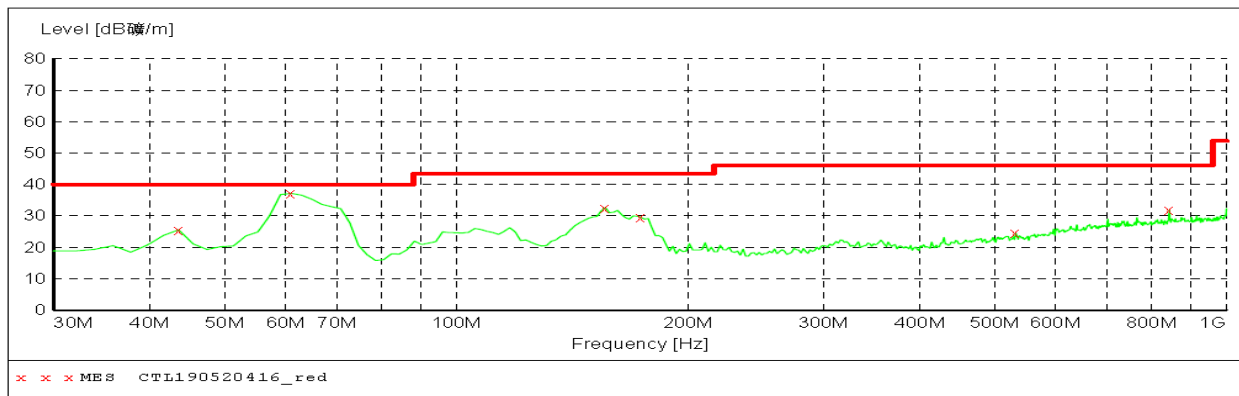

**MEASUREMENT RESULT: "CTL190520416\_red"**

2019-5-20 9:16

| Frequency MHz | Level dBμV/m | Transd dB | Limit dBμV/m | Margin dB | Det. | Height cm | Azimuth deg | Polarization |
|---------------|--------------|-----------|--------------|-----------|------|-----------|-------------|--------------|
| 43.580000     | 25.50        | 14.5      | 40.0         | 14.5      | QP   | 0.0       | 0.00        | VERTICAL     |
| 61.040000     | 34.20        | 13.2      | 40.0         | 5.8       | QP   | 0.0       | 0.00        | VERTICAL     |
| 156.100000    | 32.60        | 15.2      | 43.5         | 10.9      | QP   | 0.0       | 0.00        | VERTICAL     |
| 173.560000    | 29.50        | 13.7      | 43.5         | 14.0      | QP   | 0.0       | 0.00        | VERTICAL     |
| 532.460000    | 24.60        | 18.8      | 46.0         | 21.4      | QP   | 0.0       | 0.00        | VERTICAL     |
| 842.860000    | 31.80        | 23.0      | 46.0         | 14.2      | QP   | 0.0       | 0.00        | VERTICAL     |

### 3.3. 20dB Bandwidth

#### Limit

The 20dB bandwidth shall be less than 80% of the permitted frequency band.

#### Test Procedure

The transmitter output was connected to the spectrum analyzer through an attenuator. The bandwidth of the fundamental frequency was measured by spectrum analyzer with 30 KHz RBW and 100 KHz VBW.

The 20dB bandwidth is defined as the total spectrum the power of which is higher than peak power minus 20dB.

#### Test Configuration

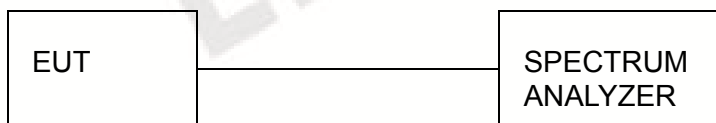

#### Test Results

| Frequency (MHz) | 20dB bandwidth (KHz) | 99% OBW (KHz) | Result |
|-----------------|----------------------|---------------|--------|
| 0.122           | 2.728                | 2.324         | Pass   |

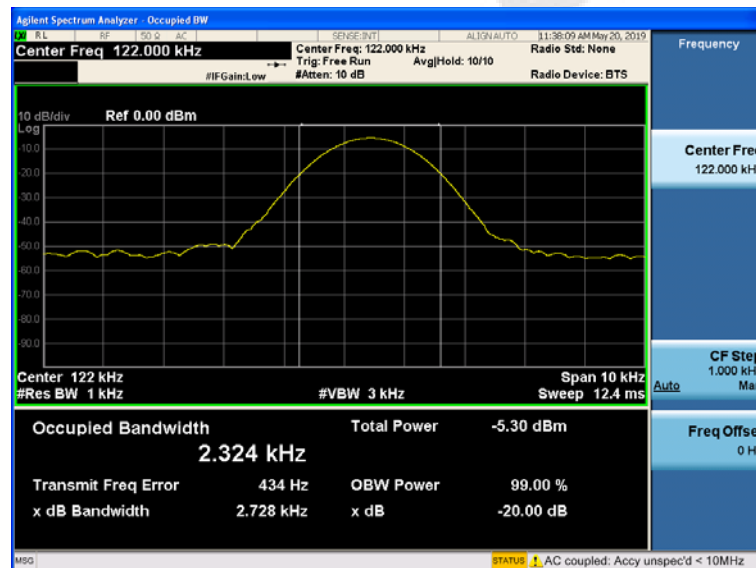



### 4. Test Setup Photos of the EUT

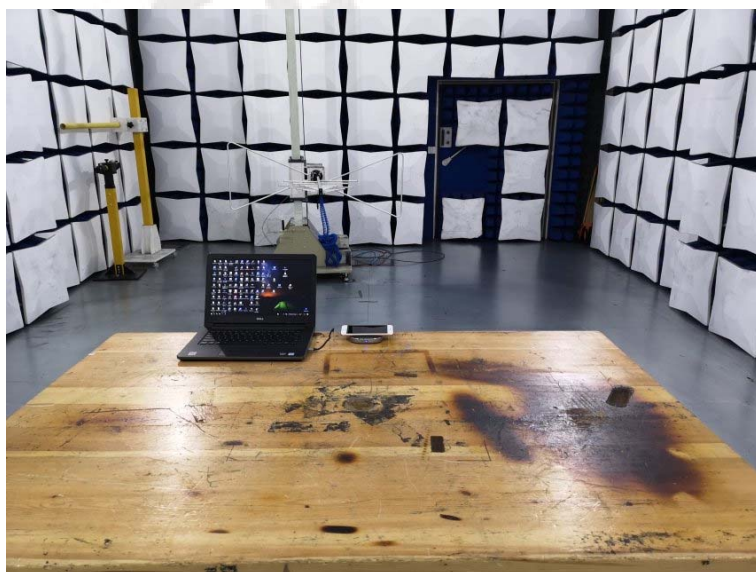
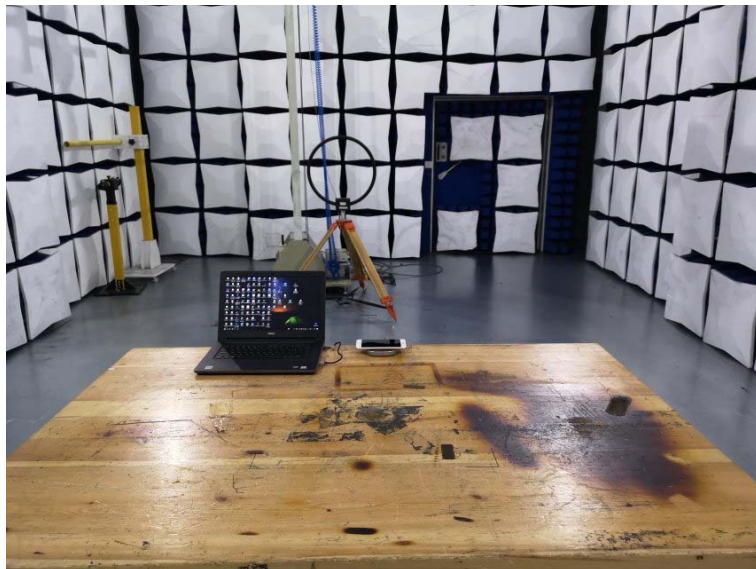

## 5. Photos of the EUT

### External Photos of EUT

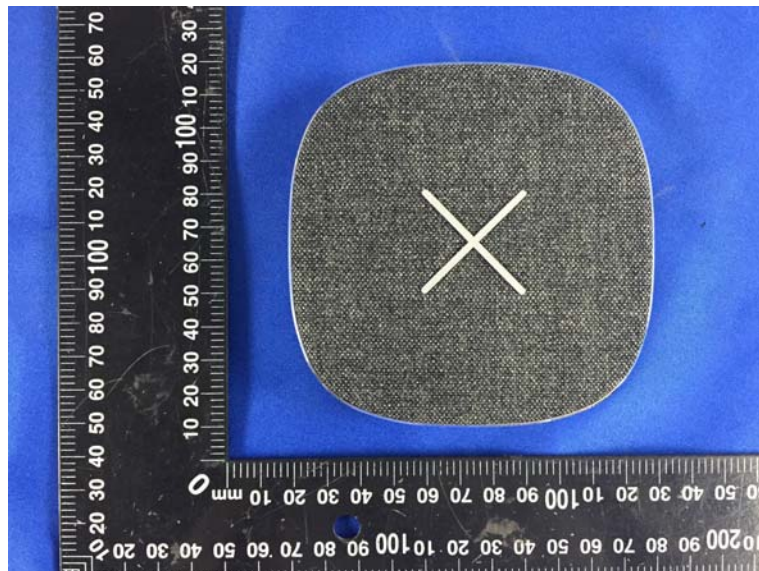
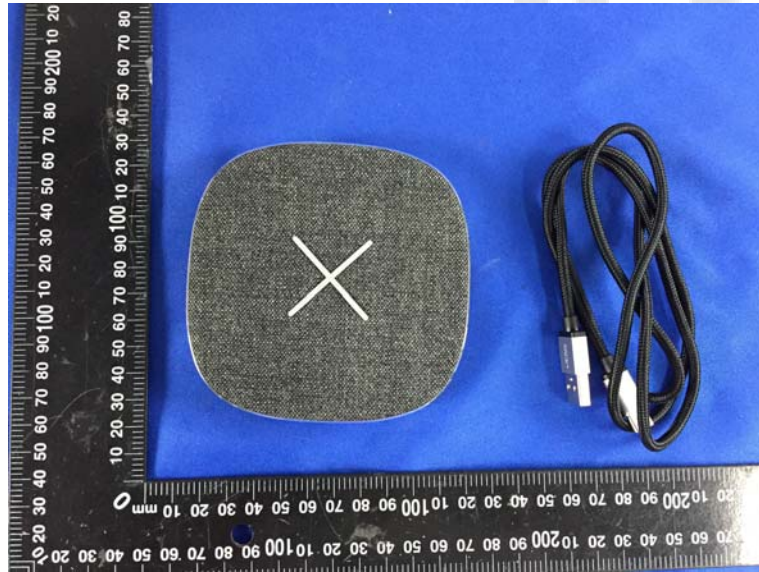

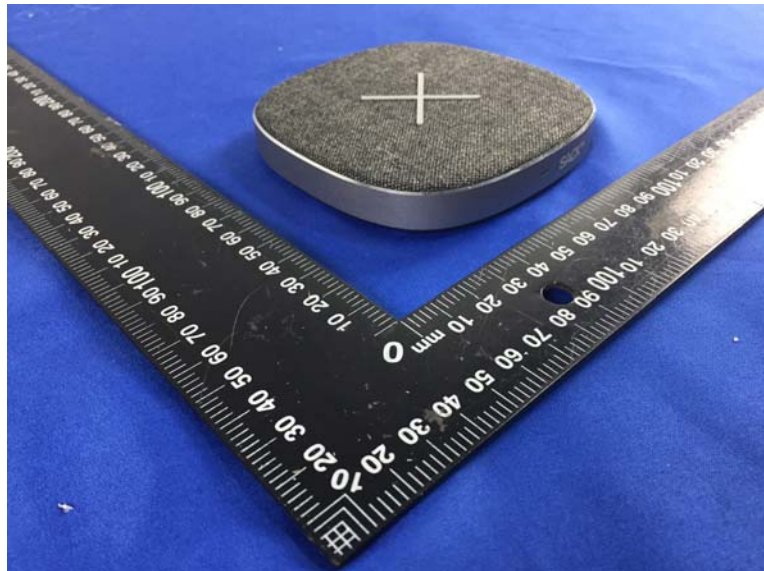

**Internal Photos of EUT**

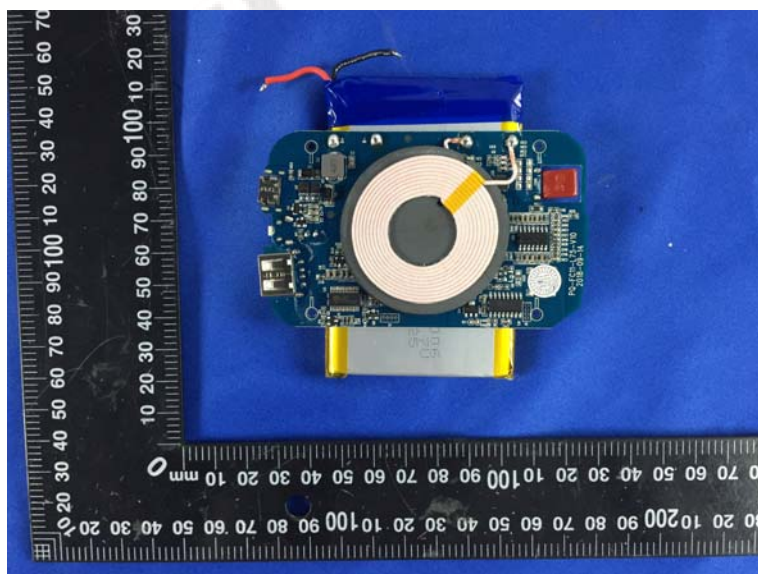
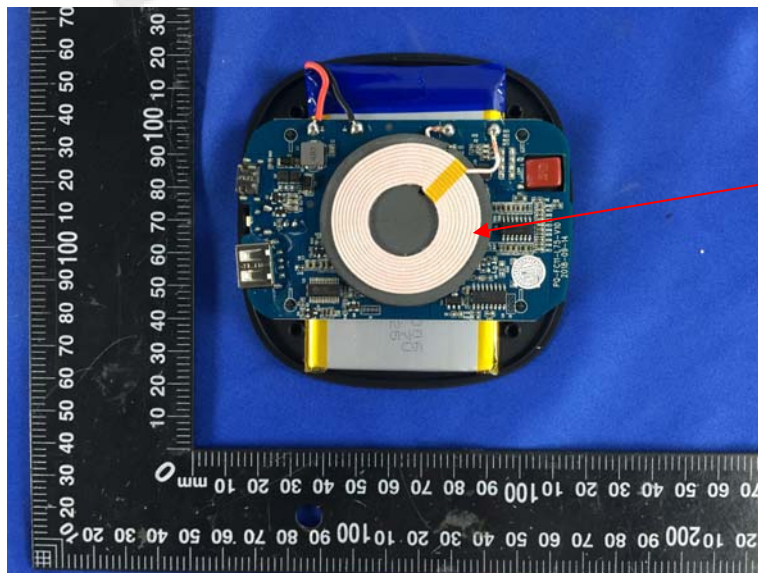

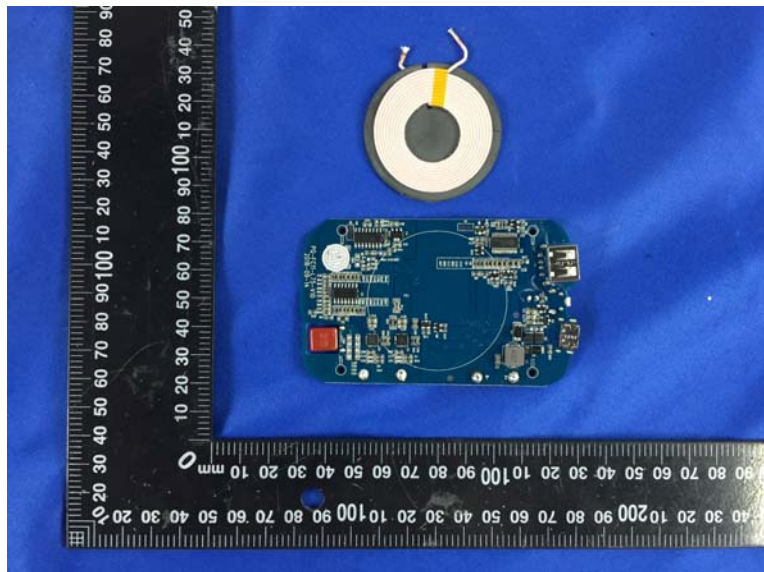
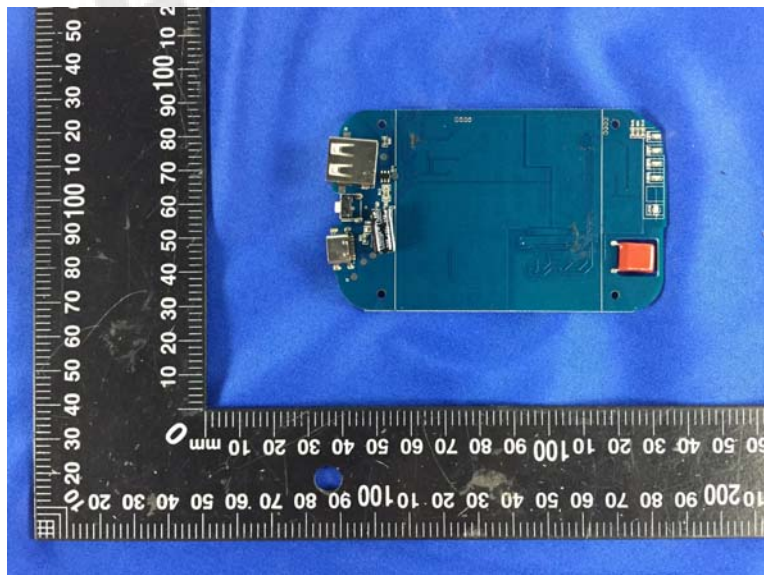
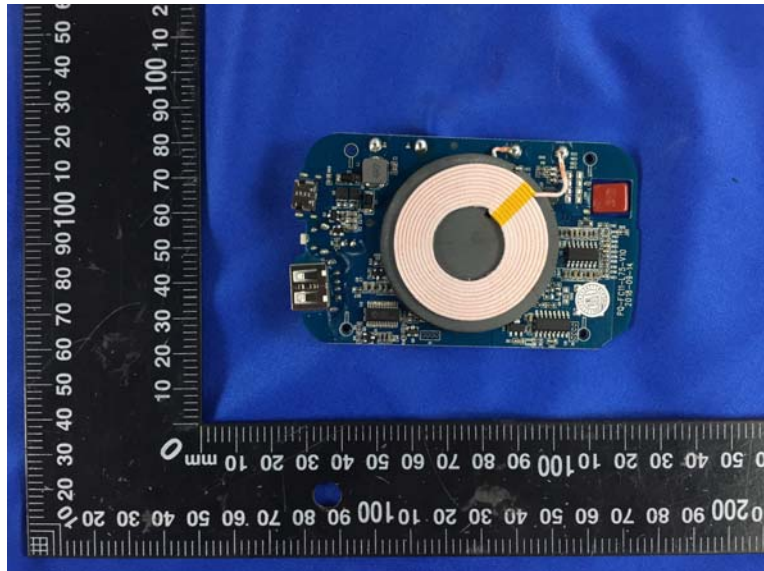

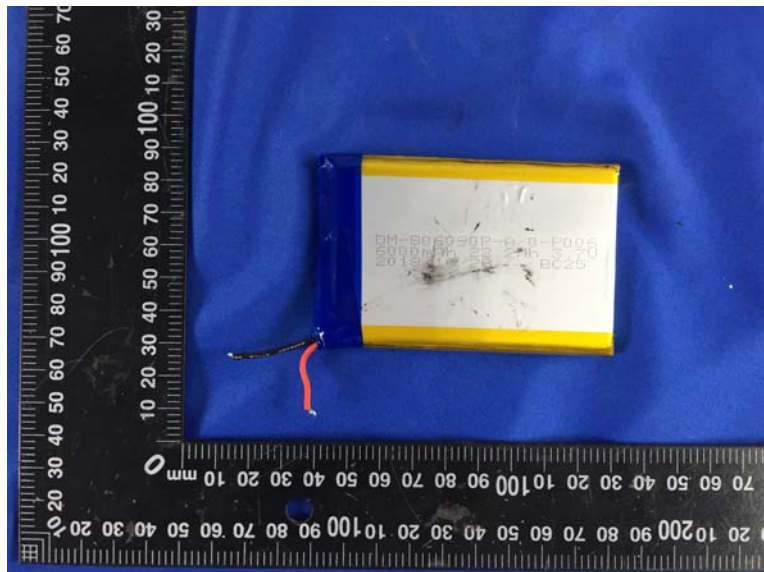
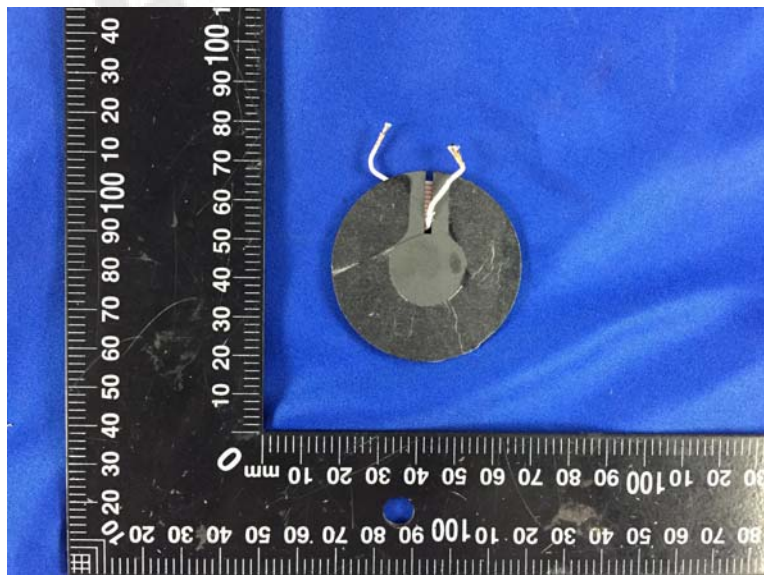
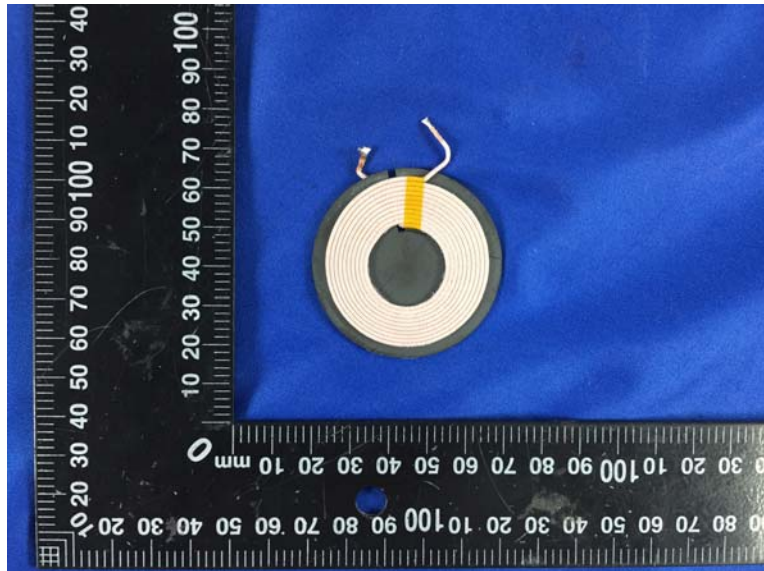

\*\*\*\*\* End of Report \*\*\*\*\*