

MEASUREMENT REPORT

(FCC : Part 15 Subpart C / ANSI C63.10-2013)



Testing Laboratory
1288

Product..... : RF module
Trade Name..... : Merits
Model No..... : FTR-R200
Applicant..... : Merits Health Products Co., Ltd.
Applicant Address..... : No. 18, Jingke Road, Nantun District, Taichung
City 408, Taiwan,R.O.C.

Report Number	MLT1803P15002
Applicant	Merits Health Products Co., Ltd.
Product	RF module
Sample Received Date	2018/3/5
Sample Tested Date	2018/3/5 ~ 2018/3/26

Report Prepared By	Jesse Tien
Signature	
Date Prepared	2018/4/10

Report Authorized By	Roger Chen
Signature	
Date Authorized	2018/4/10

Test By

Max Light Technology Co., Ltd.
 Room 5, 8F, No.125, Section 3 Roosevelt Road,
 Taipei, Taiwan., R.O.C.
 Office : Tel: 886-2-2363-2447 Fax: 886-2-2363-2597
 Lab. : Tel: 886-2-2663-3486 Fax: 886-2-2663-3582
 Lab Location :Xi Shiding Dist. New Taipei City 223 Taiwan R.O.C.

It may be duplicated completely for legal use with the allowance of the applicant.
 It shall not be reproduced except in full, without the written approval of our
 laboratory.

Table of Contents :

History of Test Report.....	4
1. General.....	5
2. Conducted Emissions Requirements	7
3. Radiated Emissions Requirements	10
4. Transmitter Bandwidth Measurements	20
5. Transmitter Duty Cycle Measurements	22
6. Verification of De-activation after 5 seconds	26
Appendix I - EUT Test Setup	28
Appendix II – Brand / Trade Name & Model No. Multiple Listee.....	30



History of Test Report

Original Report Issue Date: 2018/4/10

No additional attachment

additional attachments were issued as in the following record:

Attachment No.	Issue Date	Description
MLT1803P15002	2018/4/10	Original report

1. General

1.1 Introduction

The following measurement report is submitted on behalf of Merits Health Products **Co.**, Ltd. In support of an Intentional Periodic Radiator certification in accordance with Part 2 Subpart J and Part 15 Subpart A and C of the Commission's and Regulations.

1.2 Customer Details

Applicant Name	Merits Health Products Co., Ltd.
Applicant Address	No. 18, Jingke Road, Nantun District, Taichung City 408, Taiwan,R.O.C.
Manufacturer Name	Merits Health Products Co., Ltd.
Manufacturer Address	No. 18, Jingke Road, Nantun District, Taichung City 408, Taiwan,R.O.C.

1.3 Technical data of EUT

Equipment	RF module
Model No	FTR-R200
FCC ID	2A05VFTR-R200
Power Type	Powered By AC adapter Model : DCR-1202 Input : AC100 - 240V , 50/60Hz Output : DC12V , 2A

The EUT is a remote transmitter. The operation frequency is 315MHz.

1.4 Description of Support Equipment

The EUT itself forms a system. No support equipment is required for its normal operation.

1.5 Configuration of System Under Test

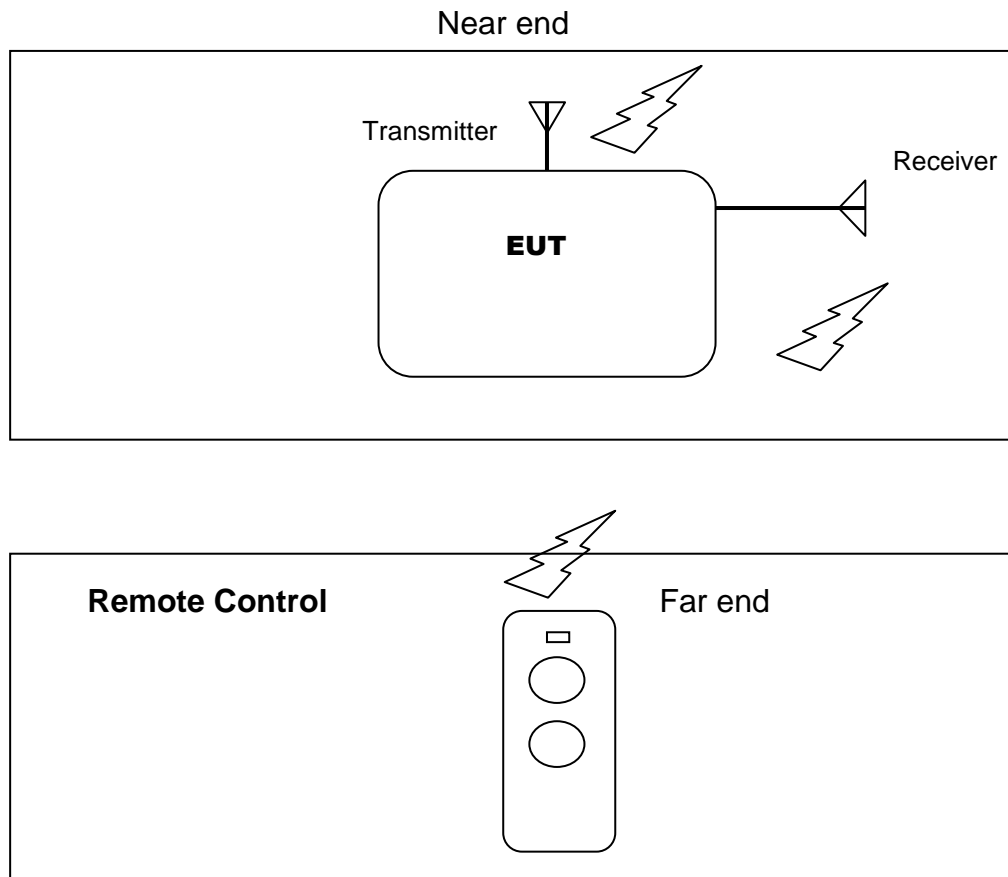

1.6 Test Procedure

All measurements contained in this report were performed according to the techniques described in Measurement procedure ANSI C63.10: 2013 "Measurement of Intentional Radiators."

1.7 General Test Condition

The conditions under which the EUT operates were varied to determine their effect on the equipment's emission characteristics. The final configuration of the test system and the mode of operation used during these tests was chosen as that which produced the highest emission levels. However, only those conditions which the EUT was considered likely to encounter in normal use were investigated.

The EUT is a manually activated device and it will follow the 15.231(b) requirement.

2. Conducted Emissions Requirements

2.1 General & Setup:

The power line conducted emission measurements were performed in a shielded enclosure. The EUT was assembled on a wooden table which is 80 centimeters high, was placed 40 centimeters from the back wall and at least 1 meter from the sidewall.

Power was fed to the EUT from the public utility power grid through a line filter and EMCO Model 3825/2 Line Impedance Stabilization Networks (LISN). The LISN housing, measuring instrumentation case, ground plane, etc., were electrically bonded together at the same RF potential. The Spectrum analyzer was connected to the AC line through an isolation transformer. The 50-ohm output of the LISN was connected to the spectrum analyzer directly. Conducted emission levels were in the CISPER quasi-peak detection mode. The analyzer's 6 dB bandwidth was set to 9 KHz. No post-detector video filter was used.

The spectrum was scanned from 150 KHz to 30 MHz. The physical arrangement of the test system and associated cabling was varied (within the scope of arrangements likely to be encountered in actual use) to determine the effect on the unit's emanations in amplitude and frequency. All spurious emission frequencies were observed. The highest emission amplitudes relative to the appropriate limit were measured and have been recorded in paragraph 2.5.

2.2 Test Equipment List:

Item	Mfr/Brand	Instruments	Serial No.	Model/Type No.	Calibrated Date	Next Cal. Date
1.	R & S	EMI Receiver	100085	ESPI	2017/12/15	2018/12/15
2.	EMCO	LISN	2658	3825/2	2017/12/11	2018/12/11
3.	EMCO	LISN	2654	3825/2	2018/01/04	2019/01/04

2.3 Test condition:

EUT tested in accordance with the specifications given by the manufacturer, and exercised in the most unfavorable manner.

2.4 Conducted Emissions Limits:

FCC Part 15

Frequency range (MHz)	Limits (dBuV)			
	Class A		Class B	
	QP	Avg.	QP	Avg.
0.15 to 0.50	79	66	66 to 56	56 to 46
0.50 to 5.0	73	60	56	46
5.0 to 30	73	60	60	50

2.5 Measurement Data Of Conducted Emissions:

2.5.1 Conducted Emissions

The following table show a summary of the highest emissions of power line conducted emissions to the HOT and NEUTRAL conductor of the EUT power.

Test Mode : Transmit

Conducted Emissions (Class B)										
Test Port	Freq (MHz)	Read(dBuV)		Factor	Limits (dBuV)		Amplitude (dBuV)		Margin (dBuV)	
		QP	AV		QP	AV	QP	AV	QP	AV
L1	0.1590	47.01	--	1.05	65.52	55.52	48.06	--	-17.46	--
	0.1924	44.44	--	1.12	63.93	53.93	45.56	--	-18.37	--
	0.5155	38.08	--	1.22	56.00	46.00	39.30	--	-16.70	--
	0.6406	37.72	--	1.22	56.00	46.00	38.94	--	-17.06	--
	0.8002	36.79	--	1.23	56.00	46.00	38.02	--	-17.98	--
	1.0370	37.85	--	1.28	56.00	46.00	39.13	--	-16.87	--
	1.4030	38.22	--	1.38	56.00	46.00	39.60	--	-16.40	--
L2	0.1573	48.05	--	0.93	65.60	55.60	48.98	--	-16.62	--
	0.1806	46.32	--	1.07	64.46	54.46	47.39	--	-17.07	--
	0.3502	39.39	--	1.09	58.96	48.96	40.48	--	-18.48	--
	0.5611	36.55	--	1.13	56.00	46.00	37.68	--	-18.32	--
	0.6508	36.80	--	1.13	56.00	46.00	37.93	--	-18.07	--
	1.0650	37.36	--	1.23	56.00	46.00	38.59	--	-17.41	--
	1.5440	35.88	--	1.39	56.00	46.00	37.27	--	-18.73	--

Notes : 1.L1: One end & Ground L2: The other end & Ground

2. Height of table on which the EUT was placed : 0.8 m.

3. The Quasi-Peak Value have already met the Average Value Limit showed on above limits.

4. The above test results are obtained under the normal condition.

5. Amplitude = Read + Factor

3. Radiated Emissions Requirements

3.1 General Configuration:

Prior to open-field testing, the EUT was placed in a shielded enclosure and scanned at a close distance to determine its emission characteristics. The physical arrangement of the EUT was varied (within the scope of arrangements likely to be encountered in actual use) to determine the effect on the unit's emanations in amplitude, directivity, and frequency. The exact system configuration which produced the highest emissions was noted so it could be reproduced later during the open-field tests. This was done to ensure that the final measurements would demonstrate the worst-case interference potential of the EUT.

3.2 General Configuration:

Final radiation measurements were made on a three-meter, open-field test site. The EUT system was placed on a nonconductive turntable which is 1.5 meters height, top surface 1.0 x 1.5 meter. The spectrum was examined from 300 MHz to 6 GHz in order to cover the whole spectrum below 10th harmonic which could generate from the EUT. During the test, EUT was set to transmit continuously & Measurements spectrum range from 30 MHz to 6 GHz is investigated.

For measurements below 1 GHz the resolution bandwidth is set to 100 kHz for peak detection measurements or 120 kHz for quasi-peak detection measurements. Peak detection is used unless otherwise noted as quasi-peak.

For measurements above 1 GHz the resolution bandwidth is set to 1 MHz, then the video bandwidth is set to 1 MHz for peak measurements and 10 Hz for average measurements.

A nonconductive material surrounded the EUT to supporting the EUT for standing on three orthogonal planes. At each condition, the EUT was rotated 360 degrees, and the antenna was raised and lowered from one to four meters to find the maximum emission levels. Measurements were taken using both horizontal and vertical antenna polarization.

The field strength below 1 GHz was measured by EMCO Biconilog Antenna (mode 3142C) at 3 Meter and the SCHWARZBECK Double Ridged Guide Antenna (model BBHA9120D&9170) was used in frequencies 1 – 40 GHz at a distance of 3 meter. All test results were extrapolated to equivalent signal at 3 meters utilizing an inverse linear distance extrapolation factor (20dB/decade).

For testing above 1GHz, the emission level of the EUT in peak mode was 20dB lower than average limit (that means the emission level in peak mode also complies with the limit in average mode), then testing will be stopped and peak values of EUT will be reported, otherwise, the emissions will be measured in average mode again and reported.

Appropriate preamplifiers were used for improving sensitivity and precautions were taken to avoid overloading or desensitizing the spectrum analyzer. No post – detector video filters were used in the test.

The spectrum analyzer's 6 dB bandwidth was set to 1 MHz, and the analyzer was operated in the peak detection mode, for frequencies both below and up 1 GHz. The average levels were obtained by subtracting the duty cycle correction factor from the peak readings.

The actual field intensity in referenced to 1 microvolt per meter (dBuV/m) is determined by algebraically adding the measured reading in dBuV, the antenna factor (dB), and cable loss (dB) and Subtracting the gain of preamplifier (dB) is auto calculate in spectrum analyzer.

$$(1) \text{ Amplitude (dBuV/m)} = \text{FI(dBuV)} + \text{AF(dBm)} + \text{CL(dBuV)} - \text{Gain(dB)}$$

FI= Reading of the field intensity.

AF= Antenna factor.

CL= Cable loss.

P.S Amplitude is auto calculate in spectrum analyzer.

$$(2) \text{ Actual Amplitude (dBuV/m)} = \text{Amplitude (dBuV)} - \text{Duty(dB)} - \text{Dis(dB)}$$

The FCC specified emission limits were calculated according the EUT operating frequency and by following linear interpolation equations:

(1) For fundamental frequency :

(1.1) For the manual transmission, according to 15.231(b)

FUNDAMENTAL FREQUENCY (MHz), excluding restricted band frequencies of Table 2	FIELD STRENGTH OF FUNDAMENTAL microvolts/m at 3 metres, (watts, EIRP)(1)	FIELD STRENGTH OF UNWANTED EMISSIONS(1) microvolt/metre at 3 metres
40.66-40.70	2250	225
70-130	1,250	125
130-174	1,250 to 3,750*	125 to 375*
174-260 (note 1)	3,750	375
260-470 (note 1)	3,750 to 12,500*	375 to 1,250*
Above 470	12,500	1250

Note : Use quasi-peak or averaging meter.

*Linear interpolation with frequency F in MHz:

For 130-174 MHz: FS (microvolts/m) = (56.82 x F) - 6136

For 260-470 MHz: FS (microvolts/m) = (41.67 x F) - 7083

(1.2) For the automatic transmission, according to 15.231(e)

FUNDAMENTAL FREQUENCY (MHz), excluding restricted band frequencies of Table 2	FIELD STRENGTH OF FUNDAMENTAL microvolts/m at 3 metres, (watts, EIRP)(1)	FIELD STRENGTH OF UNWANTED EMISSIONS(1) microvolt/metre at 3 metres
40.66-40.70	1000	100
70-130	500	50
130-174	500 to 1,500*	50 to 150*
174-260 (note 1)	1,500	150
260-470 (note 1)	1,500 to 5,000*	150 to 500*
Above 470	5,000	500

Note : Use quasi-peak or averaging meter.

* Linear interpolation with frequency F in MHz:

For 130-174 MHz: FS (microvolts/m) = (22.73 x F) – 2454.55

For 260-470 MHz: FS (microvolts/m) = (16.67 x F) – 2833.33

(2) For spurious frequency :

Spurious emission limits = fundamental emission limit /10

3.3 Test Equipment List:

Item	Mfr/Brand	Instruments	Serial No.	Model/Type No.	Calibrated Date	Next Cal. Date
1.	HP	Spectrum Analyzer	US40240137	7403A	2018/03/23	2019/03/23
2.	EMCO	Biconilog Antenna	00059739	3142C	2017/11/02	2018/11/02
3.	Agilent	Spectrum Analyzer	US44300422	E4446A	2018/03/13	2019/03/13
4.	MLT	Pre Amplifier	TA010-190-30	RF03	2017/08/02	2018/08/02
5.	SCHWARZBECK	Horn Antenna	304	BBHA 9120 D	2017/12/13	2018/12/13
6.	EMCO	Biconilog Antenna	00044568	3142C	2017/11/02	2018/11/02
7.	MLT	Pre Amplifier	20110209	PREAMP6G-01	2017/03/29	2018/03/29

3.4 Measurement Data Of Radiated Emissions:

3.4.1 Open Field Radiated Emissions (Horizontal/X-axis)

The highest peak values of radiated emissions from the EUT at various antenna heights, antenna polarization, EUT orientation, etc. are recorded on the following

Test Mode : Transmit

Radiated Emissions (Fundamental Frequency)									
Freq (MHz)	Read (dBuV/m)	Factor (dB)	Amplitude (Pk) (dBuV/m)	Ant (m)	Table (Degree)	Duty (dB)	Actual Amp(AV) (dBuV/m)	Limit (dBuV/m)	Margin (dB)
314.70	99.63	-30.88	68.75	1	260	8.16	60.59	75.62	-15.03
Freq (MHz)	Read (dBuV/m)	Factor (dB)	Amplitude (Pk) (dBuV/m)	Ant (m)	Table (Degree)		Actual Amp(PK) (dBuV/m)	Limit (dBuV/m)	Margin (dB)
314.70	99.63	-30.88	68.75	1	260		68.75	95.62	-26.87

Radiated Emissions (Unwanted Frequency)									
Freq (MHz)	Read (dBuV/m)	Factor (dB)	Amplitude (Pk) (dBuV/m)	Ant (m)	Table (Degree)	Duty (dB)	Actual Amp(AV) (dBuV/m)	Limit (dBuV/m)	Margin (dB)
629.70	68.14	-21.20	46.94	1	160	8.16	38.78	55.62	-16.84
944.70	56.64	-19.45	37.19	1	50	8.16	29.03	55.62	-26.59

Radiated Emissions (Unwanted Frequency)									
Freq (MHz)	Read (dBuV/m)	Factor (dB)	Amplitude (Pk) (dBuV/m)	Ant (m)	Table (Degree)	Duty (dB)	Actual Amp(AV) (dBuV/m)	Limit (dBuV/m)	Margin (dB)
1260.0	56.01	-3.98	52.03	1	150	8.16	43.87	54.00	-10.13
1576.0	53.24	-3.78	49.46	1	210	8.16	41.30	54.00	-12.70
2204.0	48.52	0.14	48.66	1	180	8.16	40.50	54.00	-13.50

- Notes :** 1. Margin = Actual Amp – Limits. 2. Distance of Measurement : 3 Meter.
 3. Height of table for EUT placed: 0.8 m(< 1GHz), 1.5m(>1GHz).
 4. ANT = Antenna height. 5. Duty = Duty cycle correction factor.
 6. Pre amplifier Gain :36dB to 40dB (30MHz to 1GHz)
 7. Pre amplifier Gain :31dB to 33dB (1GHz to 6GHz)
 8. Amplitude (Pk) = Read – Factor = Actual Amp (Pk)
 9. Actual Amp (AV) = Amplitude (Pk) – Duty.
 10. EUT Orthogonal Axes : X denotes Laid on Table ; Z denotes Side Stand ;
 Y denotes Vertical Stand.

3.4.2 Open Field Radiated Emissions (Vertical/X-axis)

The highest peak values of radiated emissions from the EUT at various antenna heights, antenna polarization, EUT orientation, etc. are recorded on the following

Test Mode : Transmit

Radiated Emissions (Fundamental Frequency)									
Freq (MHz)	Read (dBuV/m)	Factor (dB)	Amplitude (Pk) (dBuV/m)	Ant (m)	Table (Degree)	Duty (dB)	Actual Amp(AV) (dBuV/m)	Limit (dBuV/m)	Margin (dB)
314.70	94.69	-32.78	61.91	1	70	8.16	53.75	75.62	-21.87
Freq (MHz)	Read (dBuV/m)	Factor (dB)	Amplitude (Pk) (dBuV/m)	Ant (m)	Table (Degree)		Actual Amp(PK) (dBuV/m)	Limit (dBuV/m)	Margin (dB)
314.70	94.69	-32.78	61.91	1	70		61.91	95.62	-33.71

Radiated Emissions (Unwanted Frequency)									
Freq (MHz)	Read (dBuV/m)	Factor (dB)	Amplitude (Pk) (dBuV/m)	Ant (m)	Table (Degree)	Duty (dB)	Actual Amp(AV) (dBuV/m)	Limit (dBuV/m)	Margin (dB)
629.70	62.65	-17.46	45.19	1	20	8.16	37.03	55.62	-18.59
944.70	53.61	-21.77	31.84	1	190	8.16	23.68	55.62	-31.94

Radiated Emissions (Unwanted Frequency)									
Freq (MHz)	Read (dBuV/m)	Factor (dB)	Amplitude (Pk) (dBuV/m)	Ant (m)	Table (Degree)	Duty (dB)	Actual Amp(AV) (dBuV/m)	Limit (dBuV/m)	Margin (dB)
1260.0	56.94	-3.98	52.96	1	200	8.16	44.80	54.00	-9.20
1892.0	54.05	-3.04	51.01	1	40	8.16	42.85	54.00	-11.15
2204.0	52.87	0.14	53.01	1	160	8.16	44.85	54.00	-9.15

- Notes :** 1. Margin = Actual Amp – Limits. 2. Distance of Measurement : 3 Meter.
 3. Height of table for EUT placed: 0.8 m(< 1GHz), 1.5m(>1GHz).
 4. ANT = Antenna height. 5. Duty = Duty cycle correction factor.
 6. Pre amplifier Gain :36dB to 40dB (30MHz to 1GHz)
 7. Pre amplifier Gain :31dB to 33dB (1GHz to 6GHz)
 8. Amplitude (Pk) = Read – Factor = Actual Amp (Pk)
 9. Actual Amp (AV) = Amplitude (Pk) – Duty.
 10. EUT Orthogonal Axes : X denotes Laid on Table ; Z denotes Side Stand ;
 Y denotes Vertical Stand.

3.4.3 Open Field Radiated Emissions (Horizontal/Y-axis)

The highest peak values of radiated emissions from the EUT at various antenna heights, antenna polarization, EUT orientation, etc. are recorded on the following

Test Mode : Transmit

Radiated Emissions (Fundamental Frequency)									
Freq (MHz)	Read (dBuV/m)	Factor (dB)	Amplitude (Pk) (dBuV/m)	Ant (m)	Table (Degree)	Duty (dB)	Actual Amp(AV) (dBuV/m)	Limit (dBuV/m)	Margin (dB)
314.70	98.54	-30.88	67.66	1	8	8.16	59.50	75.62	-16.12
Freq (MHz)	Read (dBuV/m)	Factor (dB)	Amplitude (Pk) (dBuV/m)	Ant (m)	Table (Degree)		Actual Amp(PK) (dBuV/m)	Limit (dBuV/m)	Margin (dB)
314.70	98.54	-30.88	67.66	1	8		67.66	95.62	-27.96

Radiated Emissions (Unwanted Frequency)									
Freq (MHz)	Read (dBuV/m)	Factor (dB)	Amplitude (Pk) (dBuV/m)	Ant (m)	Table (Degree)	Duty (dB)	Actual Amp(AV) (dBuV/m)	Limit (dBuV/m)	Margin (dB)
629.70	67.25	-21.20	46.05	1	16.23	8.16	37.89	55.62	-17.73
944.70	52.64	-19.45	33.19	1	16.03	8.16	25.03	55.62	-30.59

Radiated Emissions (Unwanted Frequency)									
Freq (MHz)	Read (dBuV/m)	Factor (dB)	Amplitude (Pk) (dBuV/m)	Ant (m)	Table (Degree)	Duty (dB)	Actual Amp(AV) (dBuV/m)	Limit (dBuV/m)	Margin (dB)
1260.0	41.88	-3.98	37.90	1	100	8.16	29.74	54.00	-24.26
1576.0	43.65	-3.78	39.87	1	110	8.16	31.71	54.00	-22.29
2204.0	43.19	0.14	43.33	1	0	8.16	35.17	54.00	-18.83

- Notes :** 1. Margin = Actual Amp – Limits. 2. Distance of Measurement : 3 Meter.
 3. Height of table for EUT placed: 0.8 m(< 1GHz), 1.5m(>1GHz).
 4. ANT = Antenna height. 5. Duty = Duty cycle correction factor.
 6. Pre amplifier Gain :36dB to 40dB (30MHz to 1GHz)
 7. Pre amplifier Gain :31dB to 33dB (1GHz to 6GHz)
 8. Amplitude (Pk) = Read – Factor = Actual Amp (Pk)
 9. Actual Amp (AV) = Amplitude (Pk) – Duty.
 10. EUT Orthogonal Axes : X denotes Laid on Table ; Z denotes Side Stand ;
 Y denotes Vertical Stand.

3.4.4 Open Field Radiated Emissions (Vertical/Y-axis)

The highest peak values of radiated emissions from the EUT at various antenna heights, antenna polarization, EUT orientation, etc. are recorded on the following

Test Mode : Transmit

Radiated Emissions (Fundamental Frequency)									
Freq (MHz)	Read (dBuV/m)	Factor (dB)	Amplitude (Pk) (dBuV/m)	Ant (m)	Table (Degree)	Duty (dB)	Actual Amp(AV) (dBuV/m)	Limit (dBuV/m)	Margin (dB)
314.70	95.88	-32.78	63.10	1	148	8.16	54.94	75.62	-20.68
Freq (MHz)	Read (dBuV/m)	Factor (dB)	Amplitude (Pk) (dBuV/m)	Ant (m)	Table (Degree)		Actual Amp(PK) (dBuV/m)	Limit (dBuV/m)	Margin (dB)
314.70	95.88	-32.78	63.10	1	148		63.10	95.62	-32.52

Radiated Emissions (Unwanted Frequency)									
Freq (MHz)	Read (dBuV/m)	Factor (dB)	Amplitude (Pk) (dBuV/m)	Ant (m)	Table (Degree)	Duty (dB)	Actual Amp(AV) (dBuV/m)	Limit (dBuV/m)	Margin (dB)
629.70	65.32	-17.46	47.86	1	196	8.16	39.70	55.62	-15.92
944.70	56.46	-21.77	34.69	1	215	8.16	26.53	55.62	-29.09

Radiated Emissions (Unwanted Frequency)									
Freq (MHz)	Read (dBuV/m)	Factor (dB)	Amplitude (Pk) (dBuV/m)	Ant (m)	Table (Degree)	Duty (dB)	Actual Amp(AV) (dBuV/m)	Limit (dBuV/m)	Margin (dB)
1260.0	45.45	-3.98	41.47	1	60	8.16	33.31	54.00	-20.69
1576.0	50.88	-3.78	47.10	1	220	8.16	38.94	54.00	-15.06
2204.0	43.86	0.14	44.00	1	20	8.16	35.84	54.00	-18.16

- Notes :** 1. Margin = Actual Amp – Limits. 2. Distance of Measurement : 3 Meter.
 3. Height of table for EUT placed: 0.8 m(< 1GHz), 1.5m(>1GHz).
 4. ANT = Antenna height. 5. Duty = Duty cycle correction factor.
 6. Pre amplifier Gain :36dB to 40dB (30MHz to 1GHz)
 7. Pre amplifier Gain :31dB to 33dB (1GHz to 6GHz)
 8. Amplitude (Pk) = Read – Factor = Actual Amp (Pk)
 9. Actual Amp (AV) = Amplitude (Pk) – Duty.
 10. EUT Orthogonal Axes : X denotes Laid on Table ; Z denotes Side Stand ;
 Y denotes Vertical Stand.

3.4.5 Open Field Radiated Emissions (Horizontal/Z-axis)

The highest peak values of radiated emissions from the EUT at various antenna heights, antenna polarization, EUT orientation, etc. are recorded on the following

Test Mode : Transmit

Radiated Emissions (Fundamental Frequency)									
Freq (MHz)	Read (dBuV/m)	Factor (dB)	Amplitude (Pk) (dBuV/m)	Ant (m)	Table (Degree)	Duty (dB)	Actual Amp(AV) (dBuV/m)	Limit (dBuV/m)	Margin (dB)
314.70	102.68	-30.88	71.80	1	140	8.16	63.64	75.62	-11.98
Freq (MHz)	Read (dBuV/m)	Factor (dB)	Amplitude (Pk) (dBuV/m)	Ant (m)	Table (Degree)		Actual Amp(PK) (dBuV/m)	Limit (dBuV/m)	Margin (dB)
314.70	102.68	-30.88	71.80	1	140		71.80	95.62	-23.82

Radiated Emissions (Unwanted Frequency)									
Freq (MHz)	Read (dBuV/m)	Factor (dB)	Amplitude (Pk) (dBuV/m)	Ant (m)	Table (Degree)	Duty (dB)	Actual Amp(AV) (dBuV/m)	Limit (dBuV/m)	Margin (dB)
629.70	60.35	-21.20	39.15	1	130	8.16	30.99	55.62	-24.63
945.40	50.95	-19.59	31.36	1	260	8.16	23.20	55.62	-32.42

Radiated Emissions (Unwanted Frequency)									
Freq (MHz)	Read (dBuV/m)	Factor (dB)	Amplitude (Pk) (dBuV/m)	Ant (m)	Table (Degree)	Duty (dB)	Actual Amp(AV) (dBuV/m)	Limit (dBuV/m)	Margin (dB)
1260.0	41.80	-3.98	37.82	1	70	8.16	29.66	54.00	-24.34
1576.0	43.14	-3.78	39.36	1	300	8.16	31.20	54.00	-22.80
2204.0	43.16	0.14	43.30	1	20	8.16	35.14	54.00	-18.86

- Notes :** 1. Margin = Actual Amp – Limits. 2. Distance of Measurement : 3 Meter.
 3. Height of table for EUT placed: 0.8 m(< 1GHz), 1.5m(>1GHz).
 4. ANT = Antenna height. 5. Duty = Duty cycle correction factor.
 6. Pre amplifier Gain :36dB to 40dB (30MHz to 1GHz)
 7. Pre amplifier Gain :31dB to 33dB (1GHz to 6GHz)
 8. Amplitude (Pk) = Read – Factor = Actual Amp (Pk)
 9. Actual Amp (AV) = Amplitude (Pk) – Duty.
 10. EUT Orthogonal Axes : X denotes Laid on Table ; Z denotes Side Stand ;
 Y denotes Vertical Stand.

3.4.6 Open Field Radiated Emissions (Vertical/Z-axis)

The highest peak values of radiated emissions from the EUT at various antenna heights, antenna polarization, EUT orientation, etc. are recorded on the following

Test Mode : Transmit

Radiated Emissions (Fundamental Frequency)									
Freq (MHz)	Read (dBuV/m)	Factor (dB)	Amplitude (Pk) (dBuV/m)	Ant (m)	Table (Degree)	Duty (dB)	Actual Amp(AV) (dBuV/m)	Limit (dBuV/m)	Margin (dB)
314.70	101.54	-32.78	68.76	1	140	8.16	60.60	75.62	-15.02
Freq (MHz)	Read (dBuV/m)	Factor (dB)	Amplitude (Pk) (dBuV/m)	Ant (m)	Table (Degree)		Actual Amp(PK) (dBuV/m)	Limit (dBuV/m)	Margin (dB)
314.70	101.54	-32.78	68.76	1	140		68.76	95.62	-26.86

Radiated Emissions (Unwanted Frequency)									
Freq (MHz)	Read (dBuV/m)	Factor (dB)	Amplitude (Pk) (dBuV/m)	Ant (m)	Table (Degree)	Duty (dB)	Actual Amp(AV) (dBuV/m)	Limit (dBuV/m)	Margin (dB)
629.70	69.32	-17.46	51.86	1	200	8.16	43.70	55.62	-11.92
944.70	58.08	-21.77	36.31	1	260	8.16	28.15	55.62	-27.47

Radiated Emissions (Unwanted Frequency)									
Freq (MHz)	Read (dBuV/m)	Factor (dB)	Amplitude (Pk) (dBuV/m)	Ant (m)	Table (Degree)	Duty (dB)	Actual Amp(AV) (dBuV/m)	Limit (dBuV/m)	Margin (dB)
1260.0	45.62	-3.98	41.64	1	140	8.16	33.48	54.00	-20.52
1576.0	45.61	-3.78	41.83	1	230	8.16	33.67	54.00	-20.33
2204.0	44.55	0.14	44.69	1	0	8.16	36.53	54.00	-17.47

- Notes :** 1. Margin = Actual Amp – Limits. 2. Distance of Measurement : 3 Meter.
 3. Height of table for EUT placed: 0.8 m(< 1GHz), 1.5m(>1GHz).
 4. ANT = Antenna height. 5. Duty = Duty cycle correction factor.
 6. Pre amplifier Gain :36dB to 40dB (30MHz to 1GHz)
 7. Pre amplifier Gain :31dB to 33dB (1GHz to 6GHz)
 8. Amplitude (Pk) = Read – Factor = Actual Amp (Pk)
 9. Actual Amp (AV) = Amplitude (Pk) – Duty.
 10. EUT Orthogonal Axes : X denotes Laid on Table ; Z denotes Side Stand ;
 Y denotes Vertical Stand.

4. Transmitter Bandwidth Measurements

4.1 Test Condition & Setup:

The transmitter bandwidth measurements were performed in a shielded enclosure. The EUT was placed on a wooded table which is 0.8 meters height and a near field probe was used at a distance about 20 cm for receiving. While testing, EUT was set to transmit continuously.

The resolution bandwidth of the spectrum analyzer was set to 10KHz. The detector function was set to peak and hold mode to clearly observe the components. The maximum permitted bandwidth at -20dB with respect to the reference level specified by the rule was 0.25 % of the center frequency of the EUT.

4.2 Test Instruments Configuration:

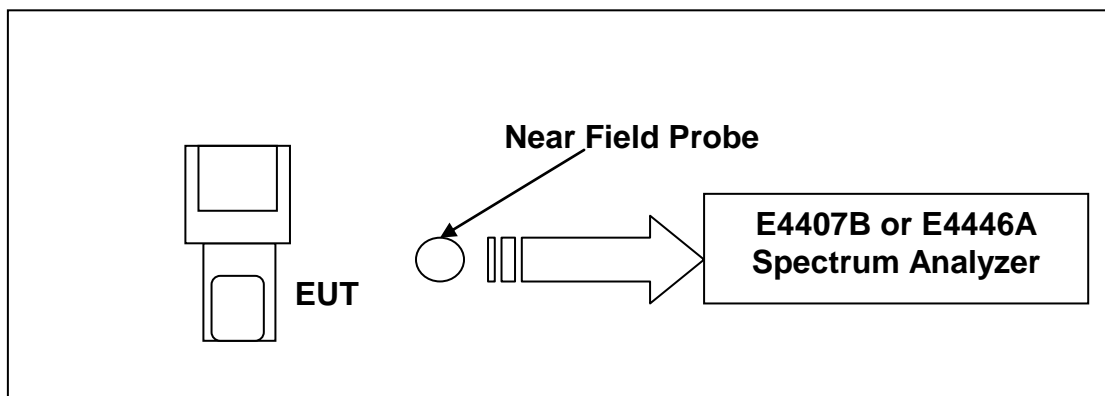

4.3 Test Equipment List:

Item	Mfr/Brand	Instruments	Serial No.	Model/Type No.	Calibrated Date	Next Cal. Date
1.	Agilent	Spectrum Analyzer	US44300422	E4446A	2018/03/13	2019/03/13
2.	Agilent	Spectrum Analyzer	US39240419	E4407B	2017/05/03	2018/05/03
3.	EMCO	Biconilog Antenna	00044568	3142C	2017/11/02	2018/11/02
4.	EM	Probe	107328	EM-6992	N/A	N/A

4.4 Test Result:

Permitted Maximum Bandwidth	787.53	KHz
Bandwidth Measurement	437.50	KHz

4.5 Test Graphs:

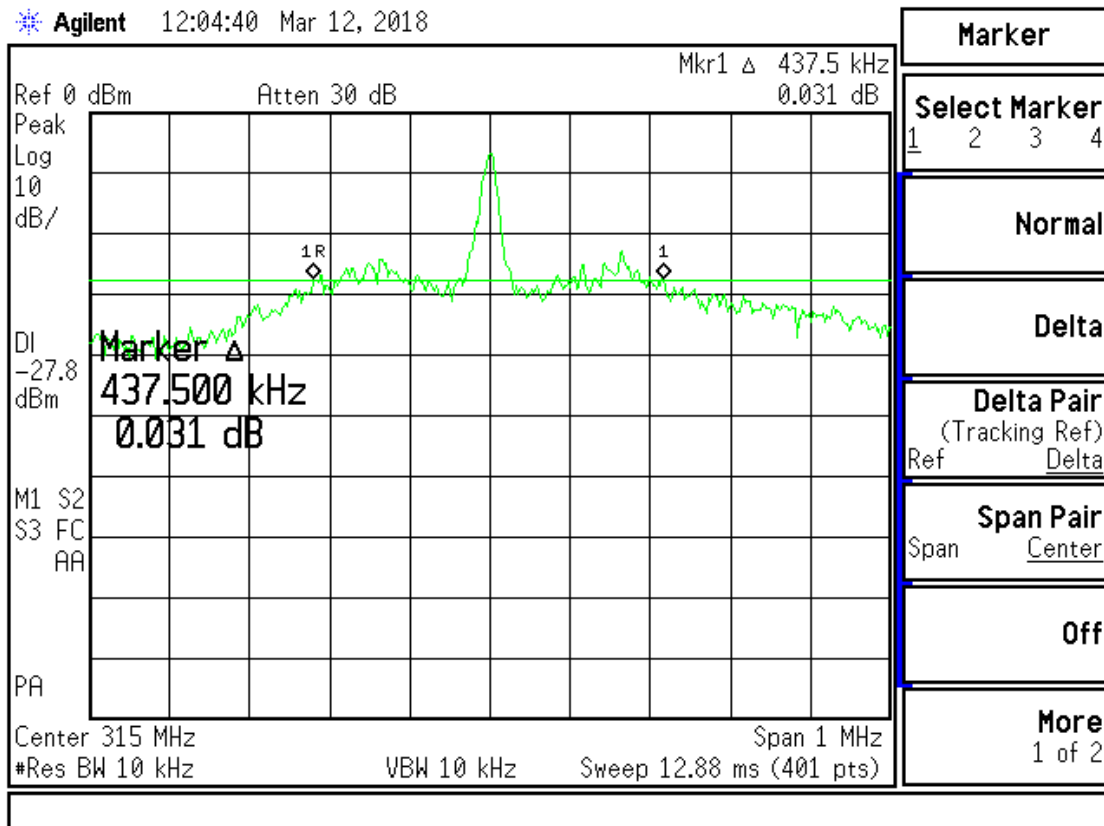

5. Transmitter Duty Cycle Measurements

5.1 Test Condition & Setup:

The transmitter bandwidth measurements were performed in a shielded enclosure. The EUT was placed on a wooded table which is 0.8 meters height and a near field probe was used at a distance about 20 cm for receiving. While testing, EUT was set to transmit continuously. Various key configurations were also investigated to find the maximum duty cycle.

The spectrum analyzer resolution bandwidth and video bandwidth were all set to 1 MHz to encompass all Significant spectral components during the test. The analyzer was operated in linear scale and zero span mode after tuning to the transmitter carrier frequency. A digital oscilloscope was connected to the aux video output of the spectrum analyzer for measuring pulse width. The pulse width was determined by the difference between the half voltage points on a pulse.

The duty cycle was determined by the following equation :

TO calculate the actual field intensity, the duty cycle correction factor in decibel is needed for later use and can be obtained from following conversion :

$$\text{Duty Cycle(\%)} = \frac{\text{(Total On Interval in a Complete Pulse Train)}}{\text{(Length of a Complete Pulse Train)}} \times 100\%$$

$$\text{Duty Cycle Correction Factor (dB)} = 20 \times \text{Log}_{10} (\text{Duty Cycle(\%)})$$

5.2 Test Instruments Configuration:

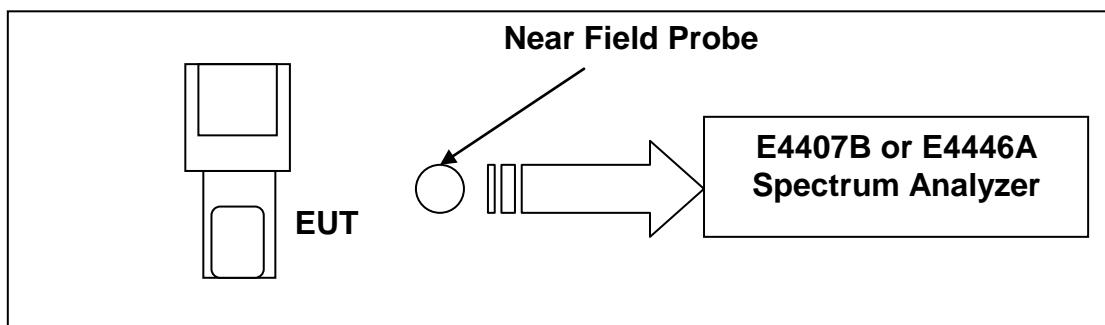

5.3 Test Equipment List:

Item	Mfr/Brand	Instruments	Serial No.	Model/Type No.	Calibrated Date	Next Cal. Date
1.	Agilent	Spectrum Analyzer	US44300422	E4446A	2018/03/13	2019/03/13
2.	Agilent	Spectrum Analyzer	US39240419	E4407B	2017/05/03	2018/05/03
3.	EMCO	Biconilog Antenna	00044568	3142C	2017/11/02	2018/11/02
4.	EM	Probe	107328	EM-6992	N/A	N/A

5.4 Test Result:

Pulse Train	Number of Pulse	T(ms)	Total Time (ms)
Long Pulse	13	1.05	13.65 msec
Middle Pulse	0	0	0 msec
Short Pulse	12	0.45	5.4 msec

Total ON interval in a complete pulse train	19.05 msec
Length of a complete pulse train	48.75 msec
Duty Cycle (%)	39.08 %
Duty Cycle Correction Factor (dB)	-8.16 * ¹ dB

Note 1: The data of duty cycle correction factor is the highest test result (worst case) in all different functions.

5.5 Test Graphs: See next page.

Length of a Complete Pulse Train

Agilent 12:12:27 Mar 12, 2018

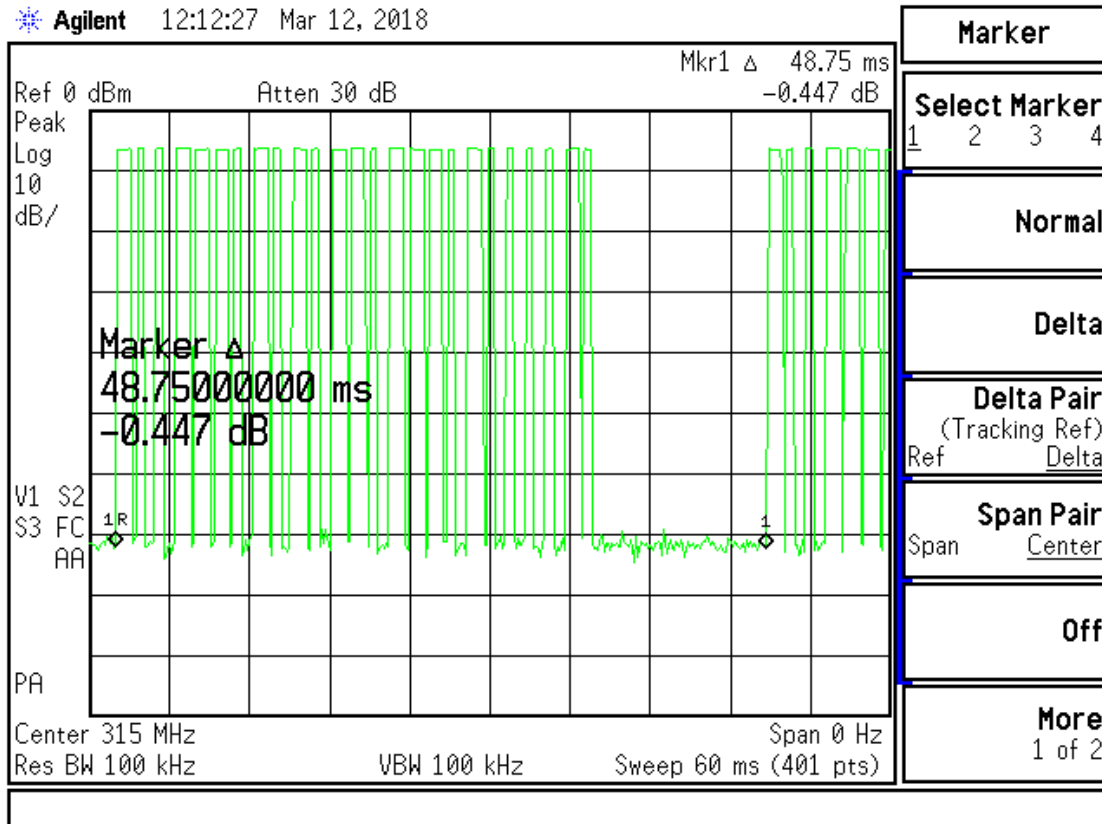

Long Pulse

Agilent 12:15:09 Mar 12, 2018

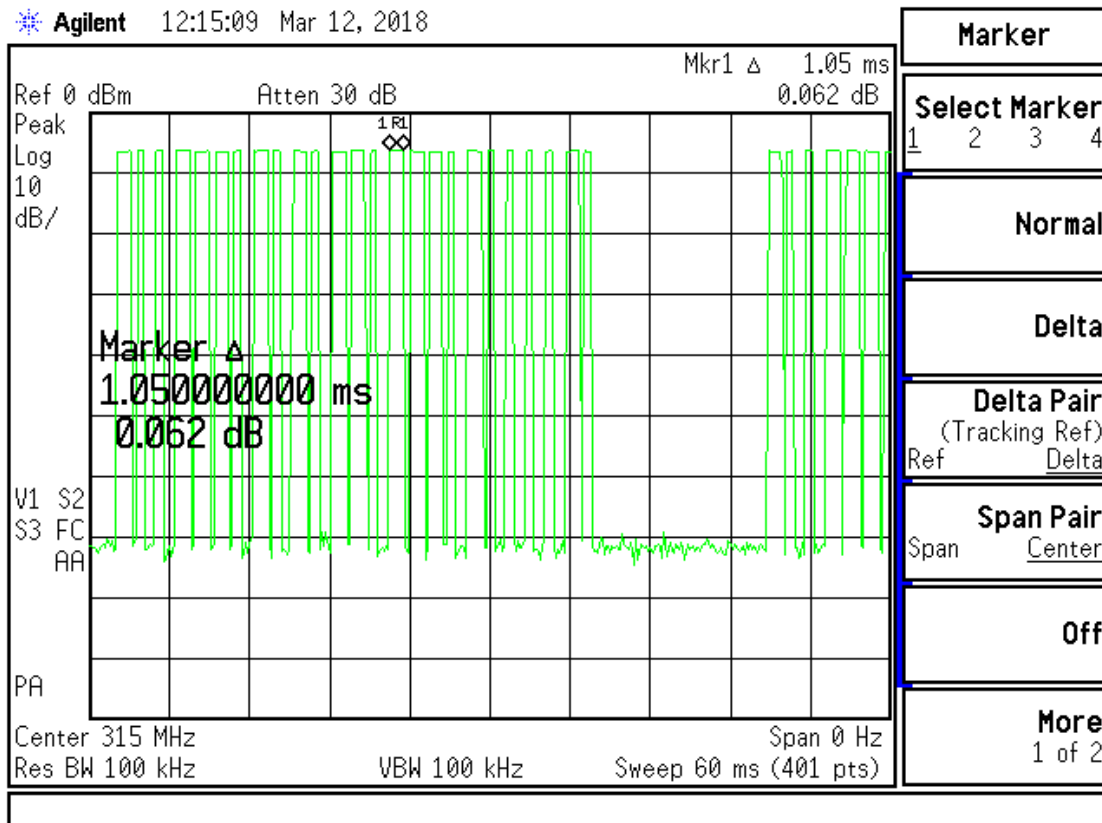

Short Pulse

Agilent 12:14:29 Mar 12, 2018

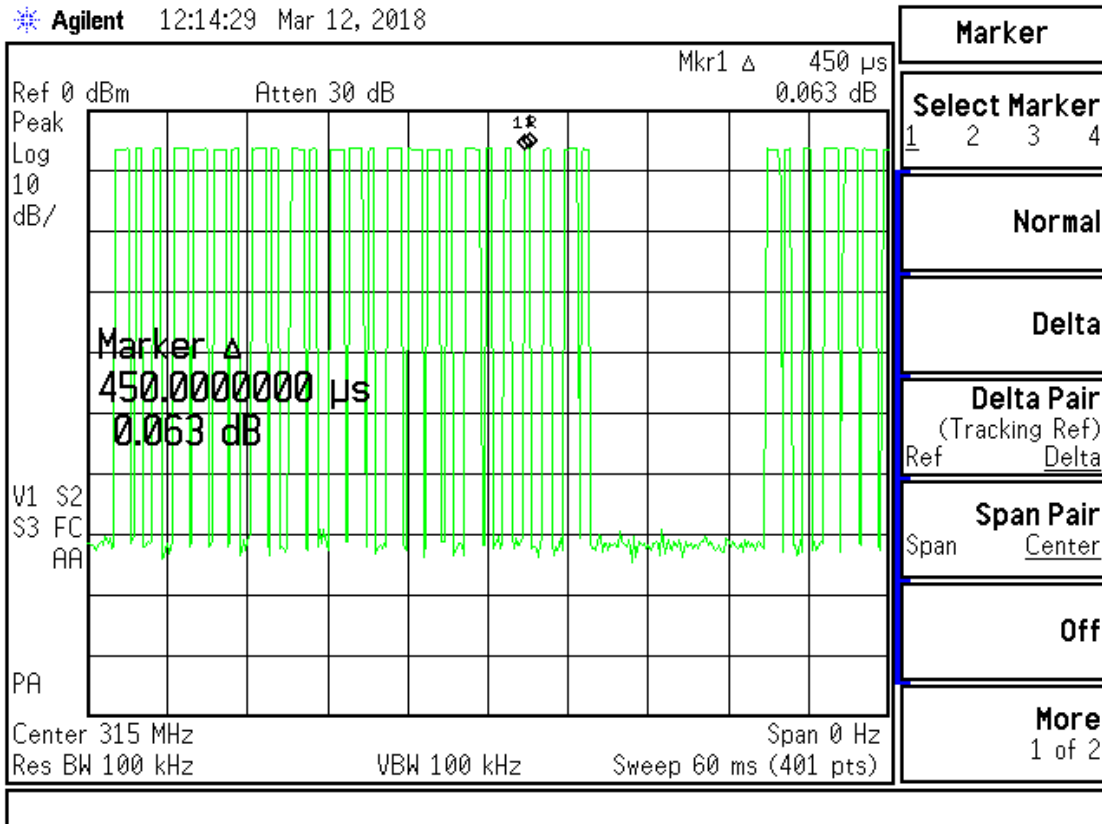

Long & Short Pulse (Number of Pulse)

Agilent 12:12:27 Mar 12, 2018

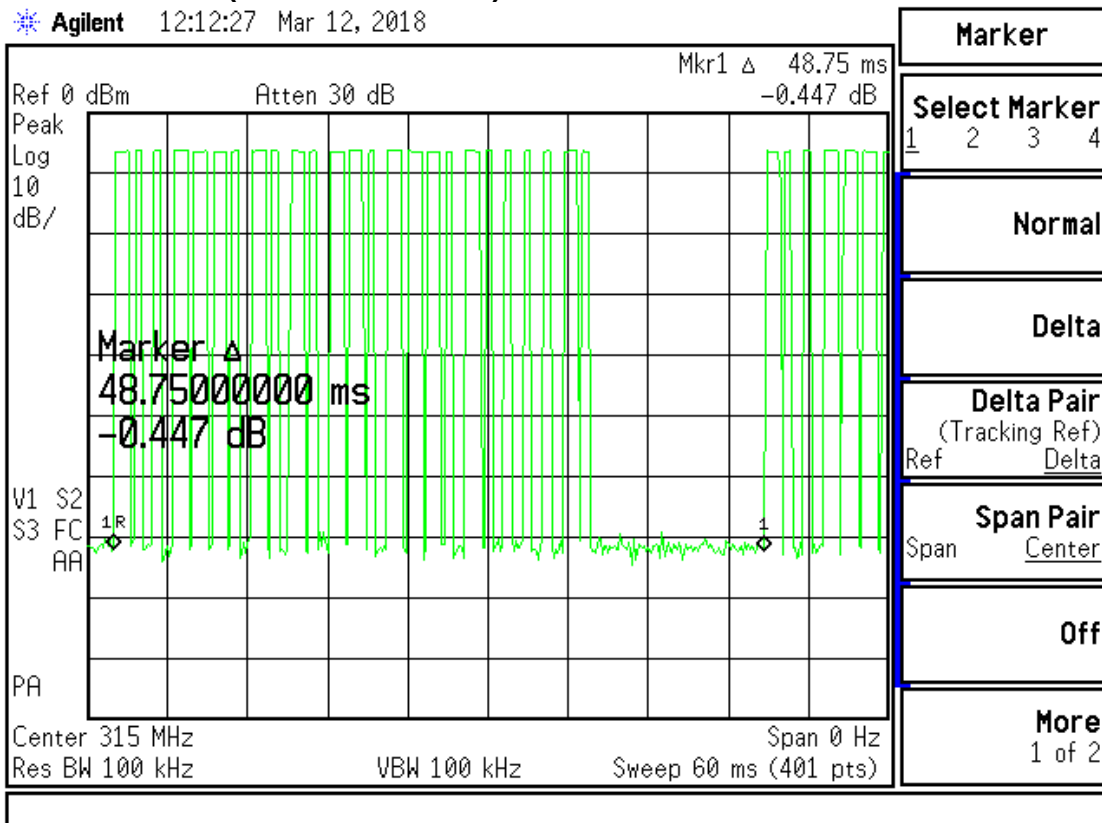

6. Verification of De-activation after 5 seconds

6.1 Test Condition & Setup:

Verification of the transmitter de-activation after 5 seconds was performed in a shielded enclosure. The EUT was placed on a wooded table which is 0.8 meters height and a near field probe was used at a distance about 20 cm for receiving.

The spectrum analyzer resolution bandwidth and video bandwidth were all set to 100KHZ to encompass all Significant spectral components during the test. The analyzer was operated in linear scale and zero span mode after tuning to the transmitter carrier frequency.

6.2 Test Instruments Configuration:

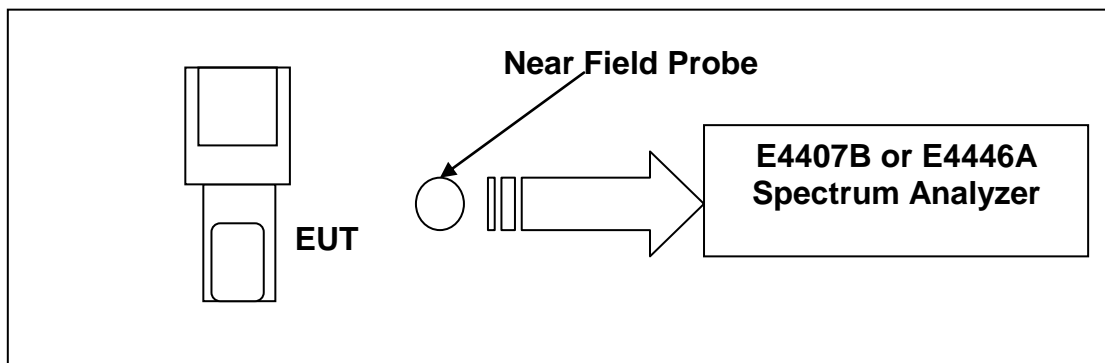

6.3 Test Equipment List:

Item	Mfr/Brand	Instruments	Serial No.	Model/Type No.	Calibrated Date	Next Cal. Date
1.	Agilent	Spectrum Analyzer	US44300422	E4446A	2018/03/13	2019/03/13
2.	Agilent	Spectrum Analyzer	US39240419	E4407B	2017/05/03	2018/05/03
3.	EMCO	Biconilog Antenna	00044568	3142C	2017/11/02	2018/11/02
4.	EM	Probe	107328	EM-6992	N/A	N/A

6.4 Test Result:

Compliant Conditions (Section 15.231)	EUT Status		
1. The EUT was manually operated	x	Yes	No
Requirement: The EUT employs a switch that would automatically deactivate the transmitter no more than 5 seconds of being released.			
2. The EUT was automatically activated		Yes	x
Requirement: The EUT operated under the provisions of this paragraph shall be provided with a means for automatically limiting operation so that the duration of each transmission shall not be greater than one second and the silent period between transmissions shall be at least 30 times the duration of the transmission but in no case less than 10 seconds.			

Duration of each transmission	2.85	sec
Silent period between transmission	N/A	sec

Duration of each transmission

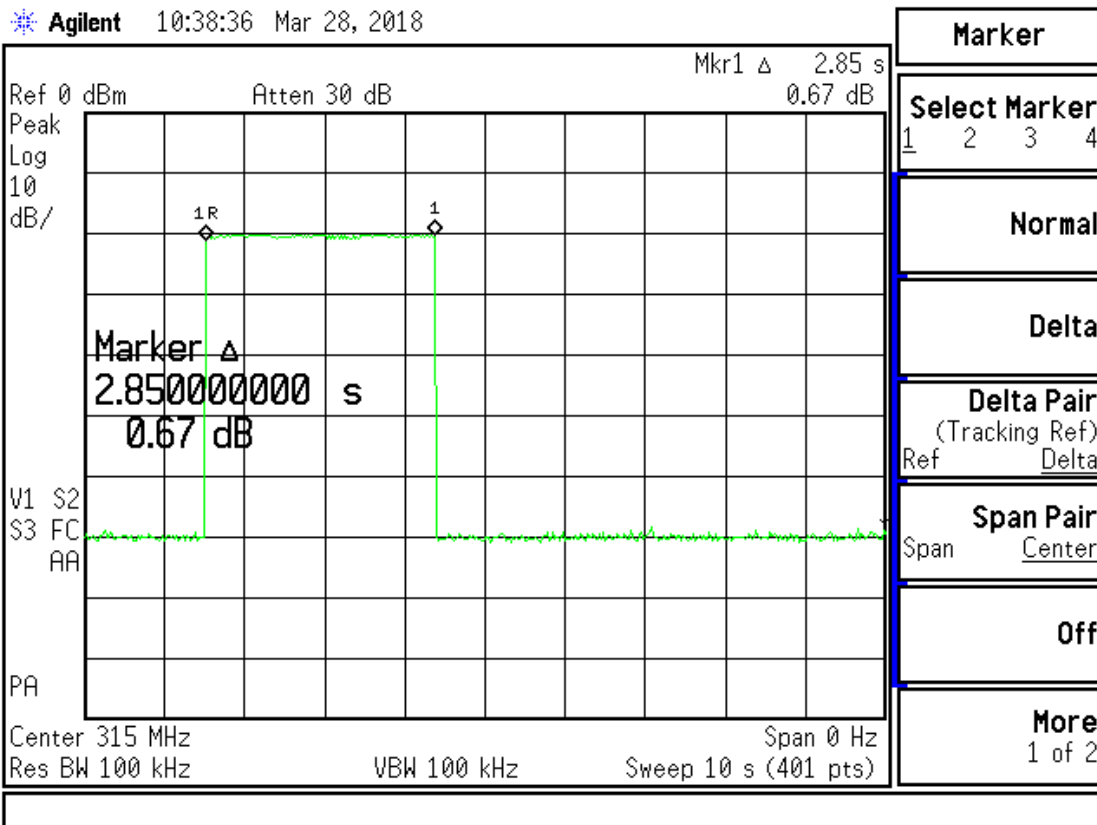

Appendix I - EUT Test Setup

MEASUREMENT OF RADIATED EMISSION

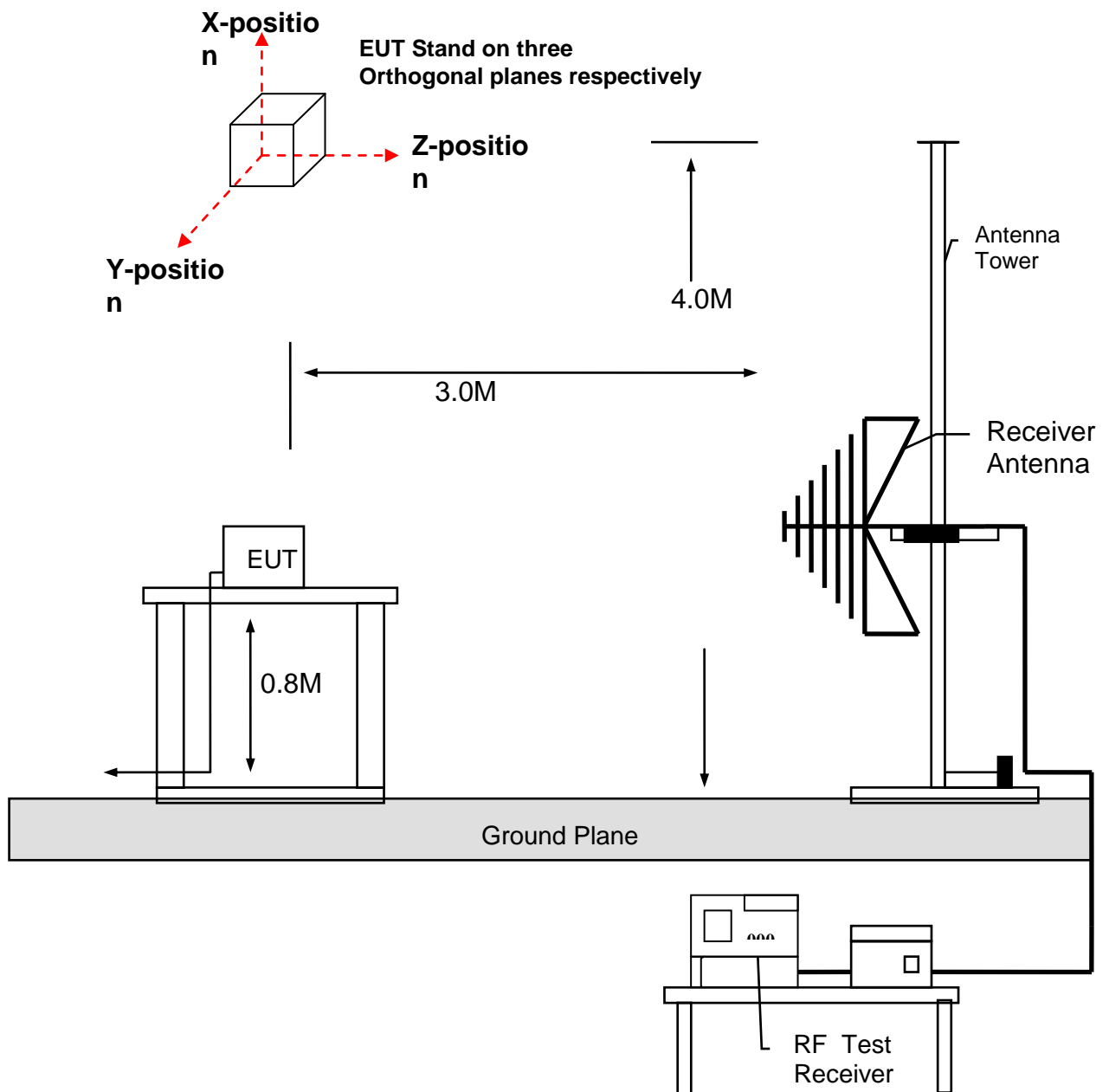

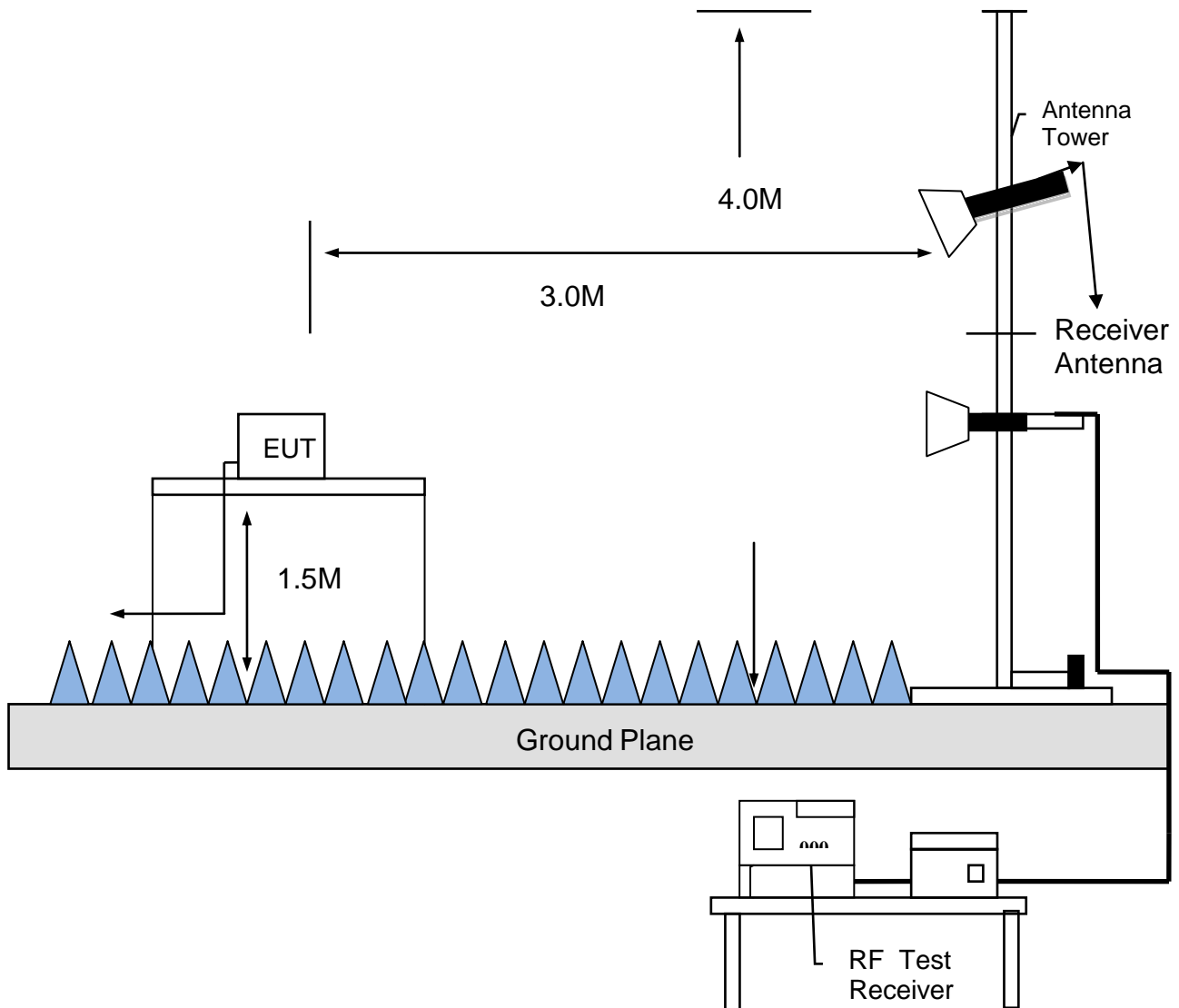

Appendix II – Brand / Trade Name & Model No. Multiple Listee

Brand /Trade Name	Model Name
N/A	N/A