

3 YEAR
WARRANTY

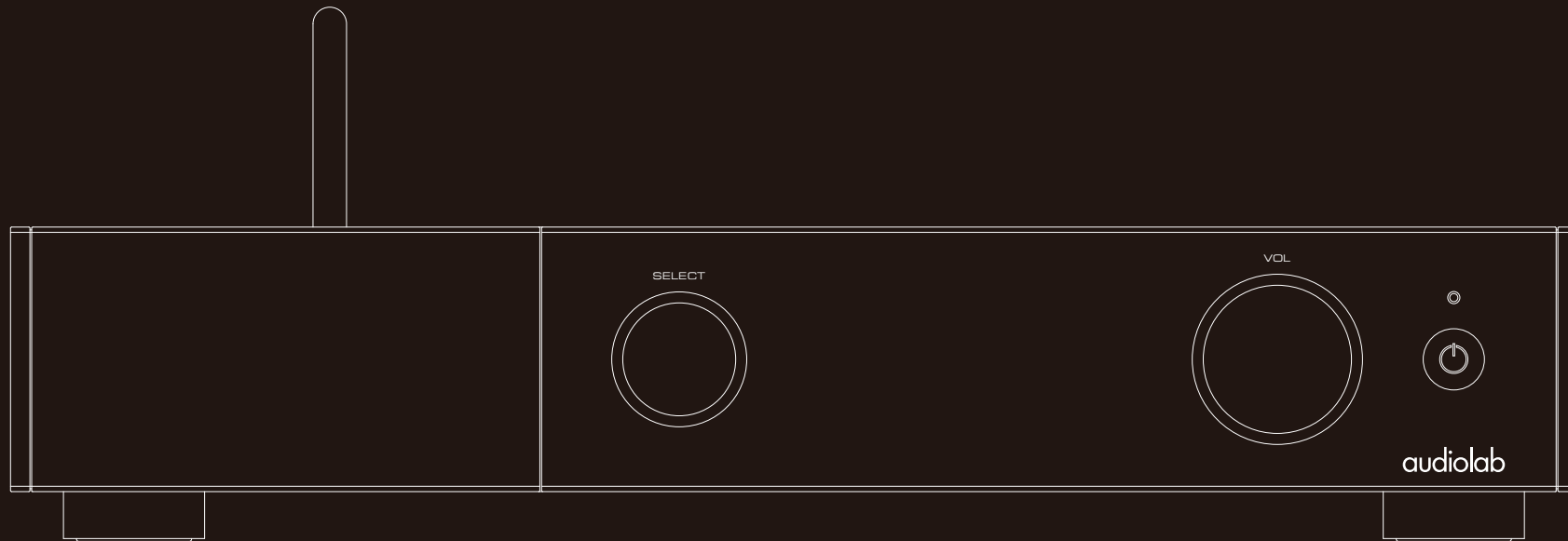

Scan the QR code using a smart-phone device,
for product warranty registration online.



9000N User Manual

audiolab

Important Safety Information



This lightning flash with an arrowhead symbol within an equilateral triangle is intended to alert the user to the presence of non-insulated "dangerous voltage" within the product's enclosure that may be of sufficient magnitude to constitute a risk of electric shock.

Warning: To reduce the risk of electric shock, do not remove cover (or back) as there are no user-serviceable parts inside. Refer servicing to qualified personnel. The exclamation point within an equilateral triangle is intended to alert the user to the presence of important operating and maintenance instructions in the literature accompanying the appliance.

Read these instructions. Keep these instructions. Heed all warnings.

Follow all instructions:

Do not use this apparatus near water. Clean only with a dry cloth.

Do not block any ventilation openings. Install under the manufacturer's instructions.

Do not install near any heat sources such as radiators, heat registers, stoves, or other apparatus (including amplifiers) that produce heat.

Do not defeat the safety purpose of the polarized or grounding-type plug. A polarized plug has two blades with one wider than the other. A grounding plug has two blades and a third grounding prong. The wide blade or the third prong is provided for your safety. If the provided plug does not fit into your outlet, consult an electrician for the replacement of the obsolete outlet.

Protect the power cord from being stepped on or pinched, particularly at the plugs, convenience receptacles, and at the point where they exit from the apparatus.

Unplug this apparatus during lightning storms or when unused for long periods of time.

Refer all servicing to qualified service personnel. Servicing is required when the apparatus has been damaged in any way, such as power supply cord or plug is damaged, liquid has been spilt or objects have fallen into the apparatus, the apparatus has been exposed to rain or moisture, does not operate normally, or has been dropped.

CAUTION: These servicing instructions are for use by qualified service personnel only. To reduce the risk of electric shock, do not perform any servicing other than that contained in the operating instructions unless you are qualified to do so.

Do not install this equipment in a confined or built-in space such as a bookcase or similar unit, and keep well ventilated in an open space. The ventilation should not be impeded by covering the ventilation openings with items such as newspaper, tablecloths, curtains etc.

WARNING: Only use attachments/accessories specified or provided by the manufacturer (such as the exclusive supply adapter, battery etc.).

WARNING: Please refer to the information on the exterior panel of the enclosure for electrical and safety information before installing or operating the apparatus.

WARNING: To reduce the risk of fire or electric shock, do not expose this apparatus to rain or moisture. The apparatus shall not be exposed to dripping or splashing and that objects filled with liquids, such as vases, shall not be placed on the apparatus.

WARNING: For the terminals marked with the symbol of "⚡" may be of sufficient magnitude to constitute a risk of electric shock. The external wiring connected to the terminals requires installation by an instructed person or the use of ready-made leads or cords.



Ground protection terminal. This product should be connected to a power outlet with ground protection.

Denmark: Apparatets stikprop skal tilsluttes en stikkontakt med jord, som giver forbindelse til stikproppens jord.

Finland: Laite on liitettävä suojakoskettimilla varustettuun pistorasiaan.

Norway: Apparatet må tilkoples jordet stikkontakt.

Sweden: Apparatens skall anslutas till jordat uttag.

WARNING: No naked flame sources, such as lighted candles, should be placed on the apparatus.

WARNING: Attention should be drawn to environmental aspects of battery disposal. **WARNING:** Use of the apparatus in tropical climates.

THE FUSE VALUES ARE:

220 – 240V (UK, China, etc.) T 1.0AL 250V Slow Blow

100 – 120V (USA, Japan, etc.) T 1.6AL 250V Slow Blow

Important Safety Information

FCC Statement

This equipment has been tested and found to comply with the limits for a Class B digital device, pursuant to part 15 of the FCC Rules. These limits are designed to provide reasonable protection against harmful interference in a residential installation. This equipment generates, uses and can radiate radio frequency energy and, if not installed and used in accordance with the instructions, may cause harmful interference to radio communications. However, there is no guarantee that interference will not occur in a particular installation. If this equipment does cause harmful interference to radio or television reception, which can be determined by turning the equipment off and on, the user is encouraged to try to correct the interference by one or more of the following measures:

- Reorient or relocate the receiving antenna.
- Increase the separation between the equipment and receiver.
- Connect the equipment into an outlet on a circuit different from that to which the receiver is connected.
- Consult the dealer or an experienced radio/TV technician for help.

Caution: Any changes or modifications to this device not explicitly approved by manufacturer could void your authority to operate this equipment.

This device complies with part 15 of the FCC Rules. Operation is subject to the following two conditions: (1) This device may not cause harmful interference, and (2) this device must accept any interference received, including interference that may cause undesired operation.

- RF Exposure Information
- The device has been evaluated to meet general RF exposure requirement.
- The device can be used in portable exposure condition, compliance with exposure requirements.

ISED Statement

This device contains license-exempt transmitter(s)/receiver(s) that comply with Innovation, Science and Economic Development Canada's licence-exempt RSS(s). Operation is subject to the following two conditions:

- (1) This device may not cause interference.
- (2) This device must accept any interference, including interference that may cause undesired operation of the device.

The digital apparatus complies with Canadian CAN ICES-3 (B)/NMB-3(B).

This device meets the exemption from the routine evaluation limits in section 2.5 of RSS 102 and compliance with RSS 102 RF exposure, users can obtain Canadian information on RF exposure and compliance.

This equipment complies with Canada radiation exposure limits set forth for an uncontrolled environment.

The device has been evaluated to meet general RF exposure requirement. This equipment should be installed and operated with a minimum distance of 20cm between the radiator & your body.

The device for operation in the band 5150-5250 MHz is only for indoor use to reduce the potential for harmful interference to co-channel mobile satellite systems.

ROON
READY

Being Roon Ready means that 9000N uses Roon streaming technology, for an incredible user interface, simple setup, rock-solid daily reliability, and the highest levels of audio performance, without compromise.

MQA

MQA (Master Quality Authenticated)

MQA is an award-winning British technology that delivers the sound of the original master recording. The master MQA file is fully authenticated and is small enough to stream or download. Visit mqa.co.uk for more information. 9000N includes MQA technology, which enables you to playback MQA audio files and streams, delivering the sound of the original master recording.

MQA and the Sound Wave Device are registered trademarks of MQA Limited ©2016

MQA

The Audiolab 9000N MQA on-screen indicator glows green or blue to indicate that the unit is decoding and playing an MQA stream or file, and denotes provenance to ensure that the sound is identical to that of the source material. It glows blue to indicate it is playing an MQA Studio file, which has either been approved in the studio by the artist/producer or has been verified by the copyright owner

Important Safety Information

French: Cet appareil contient des émetteurs/récepteurs exempts de licence qui sont conformes aux RSS exemptés de licence d'Innovation, Sciences et Développement économique Canada.

L'exploitation est soumise aux deux conditions suivantes :

(1) Cet appareil ne doit pas provoquer d'interférences.

(2) Cet appareil doit accepter toute interférence, y compris les interférences susceptibles de provoquer un fonctionnement indésirable de l'appareil.

l'appareil numérique du ciem conforme canadien peut - 3 (b) / nmb - 3 (b).

This device meets the exemption from the routine evaluation limits in section 2.5 of RSS 102 and compliance with RSS 102 RF exposure, users can obtain Canadian information on RF exposure and compliance.

cet appareil est conforme à l'exemption des limites d'évaluation courante dans la section 2.5 du cnr - 102 et conformité avec rss 102 de l'exposition aux rf, les utilisateurs peuvent obtenir des données canadiennes sur l'exposition aux champs rf et la conformité.

This equipment complies with Canada radiation exposure limits set forth for an uncontrolled environment.

Cet équipement est conforme aux limites d'exposition aux rayonnements du Canada établies pour un environnement non contrôlé.

Cet équipement doit être installé et utilisé à une distance minimale de 20 cm entre le radiateur et votre corps.

L'appareil pour fonctionner dans la bande 5150-5250 MHz est uniquement pour une utilisation à l'intérieur pour réduire le potentiel d'interférence nuisible aux systèmes satellites mobiles co-canaux.

Contents

Audiolab 9000N

1. Getting Started	6
2. Controls and Functions	7
3. Remote Handset	8
4. Connections	9
5. Menu Options	12
6. System Functions	13
7. Network Connection	16
8. Playback Functions	18
9. Warranty Coverage	20
10. Specification	22

Introduction of 9000N

Welcome to the Audiolab 9000N.

The 9000N combines the incredibly capable and equally stable streaming platform with Audiolabs' digital know-how, world-beating DAC implementation and signal flow, and the intuitive 9000 series general user interface, for the ultimate streaming solution.

We hope you will enjoy its performance for many years to come. Please read through this manual to obtain the very best performance from your 9000N.

Key Features

- ESS Sabre ES9038Pro 32bit DAC
- Quad Arm® Cortex®-A53 core, 1.8 GHz per Core
- Audiolab 9000N MUSIC Streaming technology (IEEE 802.11 a/b/g/n/ac, 2.4/5GHz)
- UPnP AV protocol with audio streaming extension (OpenHome)
- Built-in Certified MQA Full decoder (via streaming & PC USB)
- Native support for Spotify Connect, TIDAL Connect, MQA, Qobuz and TunesIn Radio • Roon Ready
- Gapless Playback
- High-resolution album artwork display

Inputs

- Dual band Wi-Fi connection (802.11 a/b/g/n/ac)
- Gigabit Ethernet port
- USB 2.0 port for replaying audio from a compatible host
- One 12V Trigger input/link
- PC USB

Outputs

- One balanced analogue output pair
- One unbalanced analogue output pair
- One optical SPDIF digital output
- One coaxial SPDIF digital output

Unpacking the Equipment

The carton should contain:

- The Audiolab 9000N
- One USB A-B cable
- One IEC power cord suitable for your area
- One remote handset
- One instruction manual
- One Quick Start Guide

Please note: The remote control requires 2 x AAA type batteries. Due to international shipping and courier regulations with Lithium-Ion batteries, the remote controller battery is not included in this package.

Consult the dealer from whom you purchased the equipment if any item is not present. Carefully unpack the unit and accessories. Take care not to damage the surface finish when undoing the protective polythene sleeve. Retain the packing materials for future use. Retain the user manual and information concerning the date and place of purchase of your equipment for future reference. If you transfer the unit to a third party, please pass on this instruction manual along with the equipment.

Placement

The unit must be mounted on a solid, level and stable surface.

Before you connect the Audiolab 9000N to the AC mains power, ensure your AC mains voltage corresponds to the rating on the rear panel of the product. If in doubt, consult your dealer. If you move to an area that has a different mains voltage, seek advice from an Audiolab appointed dealer or a competent service technician.

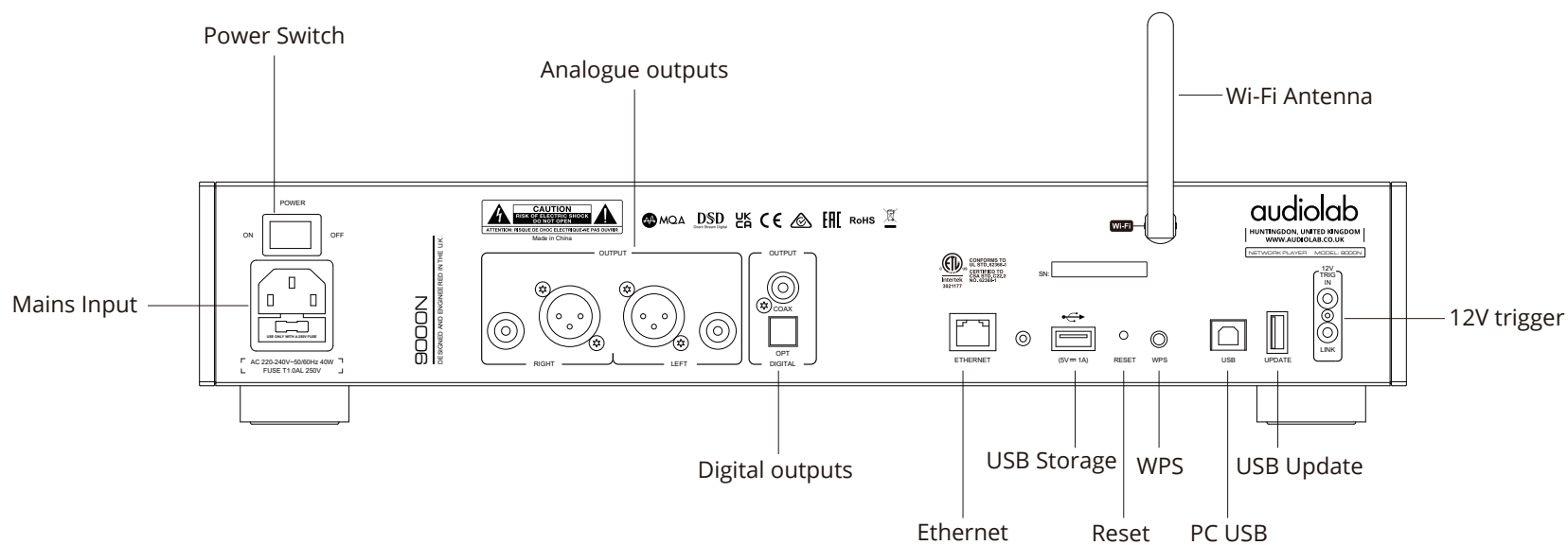
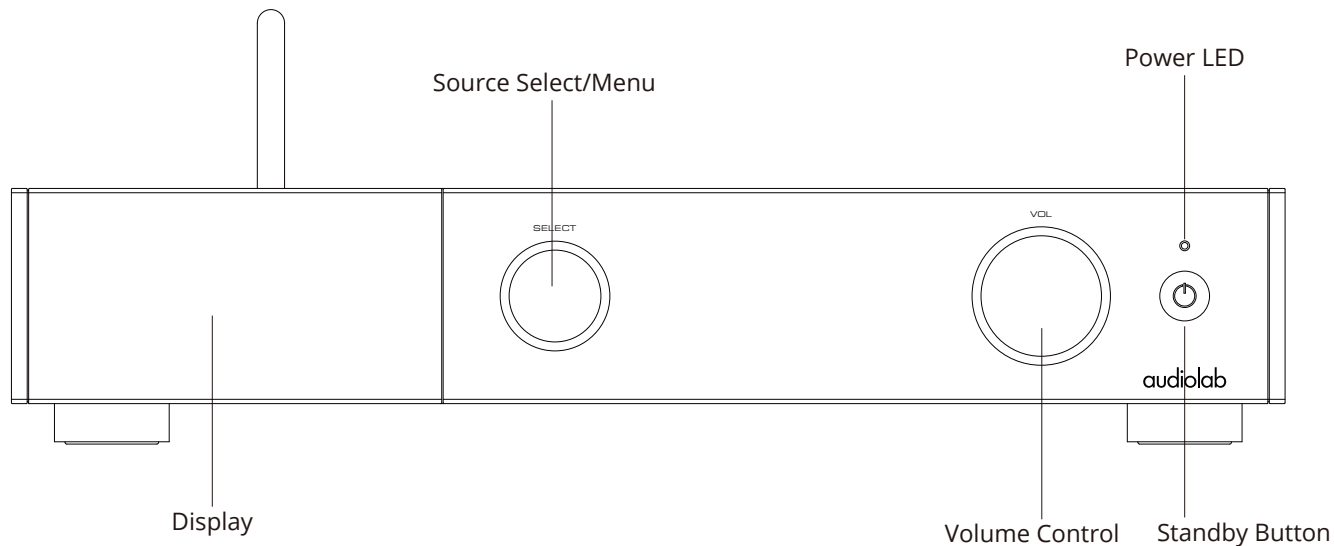

Remote Handset

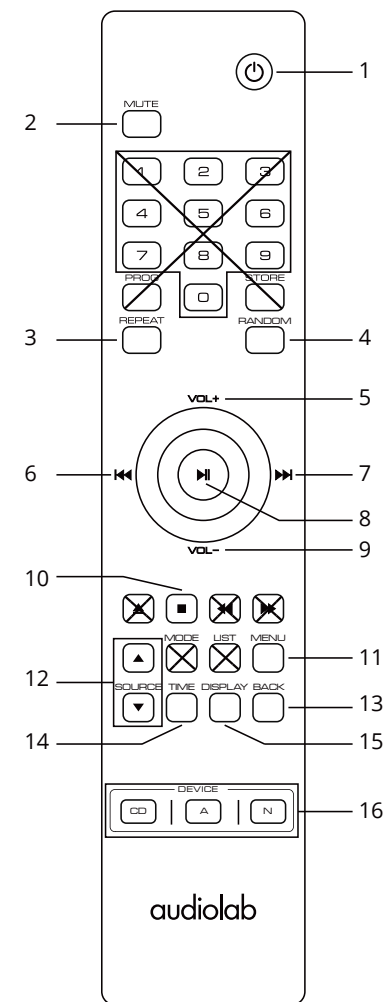

1. STANDBY	Press to put the unit in, or bring it out of standby
2.MUTE	Press to mute or unmute the 9000N
3.REPEAT	Press to select repeat mode
4. RANDOM	Press to select random mode
5. VOL+	Increase Volume/Menu settings previous option
6. ◀◀	Navigate back through Menu options, restart current track, or press twice to play the previous track in the playlist, decrease display brightness, adjust balance to the left, or decrease power-on volume limit
7. ▶▶	Navigate forward through Menu options, advance to the next track in the playlist, increase display brightness, adjust balance to the right, or increase power-on volume limit.
8. ▶◯◻	Pause and play, confirm and apply changes in Menu options, or enter a menu sub-directory
9. VOL-	Decrease Volume / Menu settings next option
10. ■	Press to stop playing
11. MENU	Press to access the setup Menu
12.SOURCE	Press to select the input source
13. BACK	Press to go back up one level in the Menu, or exit to the home screen
14.TIME	Press to toggle single track time remaining or total time of the track
15. DISPLAY	Press to toggle the display options
16. CD/A/N	Press to select the device CD/A/N

Fit the Batteries

Open the cover and insert 2*AAA batteries (not supplied), replace the cover. Always use AAA batteries and replace them in sets never mix up old and new batteries. Very weak batteries can leak and damage the handset. Replace them in good time.

Note: there is a risk of fire and injury if a battery is handled improperly. Do not disassemble, crush, puncture, short the contacts or dispose of the batteries in fire or water. Do not attempt to open or service a battery. Discard used batteries in full accordance with recycling regulation in force in your area.

Handset Operation

Point the handset at the remote receiver and press the buttons as illustrated to activate the relevant functions.

The handset should be within 15 metres of the player and there should be a clear line of sight between the handset and unit for optimum remote control operation.

Note: To get the best out of the remote control functions, please use the supplied remote control with your entire 9000 system.

The remote control supplied with your 9000N can be easily identified by the two white separator lines between the device selection buttons.

Analogue Outputs

Balanced Output

Balanced connections provide greater dynamic range and lower noise. If your amplifier has balanced inputs, it is recommended that you use the balanced output of the 9000N. You will need one XLR balanced cable per channel (ie. a stereo pair)

Unbalanced Output

If you cannot use the balanced outputs, connect a high quality stereo screened RCA cable from the unbalanced outputs of the 9000N to a suitable input of the amplifier.

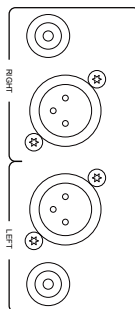

Digital Outputs

The 9000N offers one Coaxial and one Optical SPDIF digital output. Connect a suitable Digital Coaxial (fully screened) interconnect or Optical cable from the appropriate SPDIF output of the 9000N to the input of a DAC or digital input on your chosen amplifier or preamplifier.

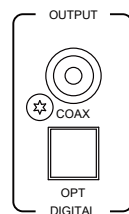

Note: The digital outputs will not be active when the 9000N is operating in 'Full Decode (PCM Upsampling ON)' mode. This is due to the operational sample rate being a minimum of 352.8kHz. Only the analogue outputs are active in this mode. The digital outputs will also be deactivated in 'Full Decode (PCM Upsampling OFF)' mode if the signal exceeds 192kHz (ie. when MQA Decoding is taking place). However, they will continue to transmit if the PCM signal is equal to or below 192kHz.

Ethernet

For optimum performance, especially with limited bandwidth and hi-res file formats, the Ethernet connection is recommended. Connect the 9000N to your router by Ethernet cable directly. A wired Ethernet connection of at least 100BASE-T is required for the 9000N.

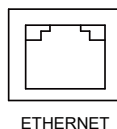

USB Storage

The 9000N includes an internal USB Music Server to allow the playback of music directly from USB storage devices.

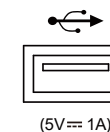

(5V = 1A)

USB-B input

Connect your 9000N to PC or MAC to play music directly from PC/MAC via USB.

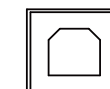

USB

USB-A Update

Updates can be downloaded from the Audiolab website and installed via USB HDD device. Please check audiolab.co.uk for the latest firmware and software updates. All instructions and details will be provided with the update files.

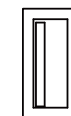

UPDATE

12V Trigger Connection

The 9000A features two 12V Trigger connections, one link output and one input. Use the link output to control other products (ie. Audiolab amplifiers or third-party compatible equipment). Use the input when the 9000N is to be controlled (ie. by Audiolab 9000A, or third-party compatible equipment). Note that the link output will only work if a trigger input is connected,

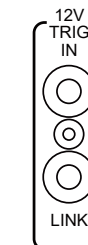

Mains Input

Before connecting the AC power cord to the 9000N, please make sure the Power Switch is in the OFF position. Switch it to the ON position after connecting the unit to the AC mains.

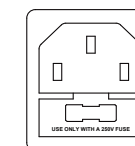

AC 220-240V-50/60Hz 40W
FUSE T1.0AL 250V

The menu enables you to customise the unit and optimise the interface with other equipment in your system.

9000N has 11 different menu pages. Press the MENU key on the remote to enter MENU mode. You can navigate the menu using the VOL- or VOL+ buttons. Confirm/access the sub menus with the >|| button. You can also navigate the menus with the SELECT knob on the front panel. Turn the knob to browse menus and press to access sub menus and confirm selections.

Filter

Configure the digital filter for the audio DAC. Linear Phase (Slow Roll-Off) is the default setting. One may prefer a particular type of filter over another.

The Audiolab 9000A ESS ES9038PRO SABRE DAC allows for detailed tuning of the audio experience. The DAC reconstruction filter is a critical part of refining the sound of a system that depends on listening taste, program material, and equipment set-up.

- Linear Phase (Fast Roll-Off): This is the most common filter with a clean overall suppression and excellent rejection, best for music with large transients. Provides crisp clean highs.
- Linear Phase (Slow Roll-Off): A low group delay and symmetrical input response with less ringing than Linear-phase fast roll-off, it offers punchier bass than "Linear-phase fast roll-off, with clean highs. (Default)
- Minimum Phase (Fast Roll-Off): This offers minimal pre-ringing. It is usually preferred for imaging and sound stages. It offers no aliasing in the frequency domain and stronger bass than Linear Phase', with clean highs.
- Minimum Phase (Slow Roll-Off): A Non-Symmetrical filter designed to minimise pre-ringing. It offers a strong punchy bass with a good transient attack.
- Hybrid: This is the combination of Linear-phase' and Minimum-phase'. It offers a fast transient attack, strong punchy bass and crisp highs.

Note: These filters are automatically disabled when streaming MQA, or if PCM Upsampling is enabled.

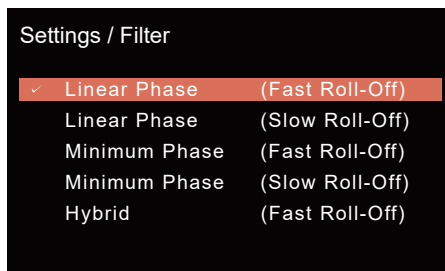

MQA Decoding

There are four MQA decoding options:

- Full Decode (PCM Upsampling Off) - This enables the full internal MQA decoding process of the 9000N, and simultaneously enables PCM streaming via SPDIF (COAX or OPTICAL) up to 192kHz. The SPDIF outputs will be switched off when MQA decoding is taking place, or if the PCM stream sample rate is above 192kHz.

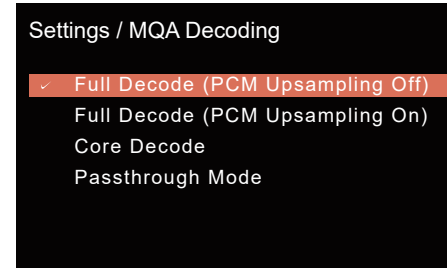

This mode is best for those streaming MQA and using the analogue outputs, or for streaming PCM (FLAC, WAV etc.) and using either analogue or digital outputs.

- Full Decode (PCM Upsampling On) - this enables the full internal MQA decoding process of the 9000N, and upsamples both MQA and PCM to 352.8kHz or 384kHz.

This mode is for use with the analogue outputs only. The SPDIF outputs (COAX and OPTICAL) are disabled.

- Core Decode - this option is suitable for users connecting to a 3rd party external MQA renderer via SPDIF, up to a sample rate of 192kHz.
- Passthrough Mode - this will bypass the MQA decoding stage in the 9000N and allow the full non-decoded signal to pass through the 9000N via the digital outputs. This mode is suited to users who prefer to use a separate DAC within their system (for example, when using the 9000N with the Audiolab 9000A). The MQA decoding will therefore happen at the external DAC stage, not within the 9000N.

Default setting is Full Decode (PCM Upsampling OFF).

Balance

Adjust the Left and Right balance of the 9000N output stage.

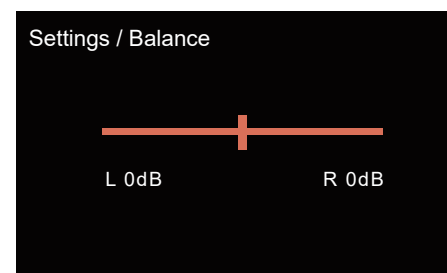

Volume

Power On Limit: Power On Limit sets the maximum volume when the unit comes out of standby. When coming out of standby, the volume will be set to the level used at the end of the previous session, or to the Power On Limit value, whichever is the lowest. This will avoid a sudden loud signal at the beginning of a new session.

Output: The analogue output level can be switched between FIXED and ADJUSTABLE.

When set to FIXED mode, the analogue output level will be fixed to the maximum output. This can be useful when connecting to an integrated amplifiers' AUX input, and therefore using the integrated amplifiers volume control.

When set to ADJUSTABLE, the 9000N Volume control is used to adjust the level of the analogue output. This is required when connecting directly to a power amplifier.

The default setting on the 9000N is ADJUSTABLE.

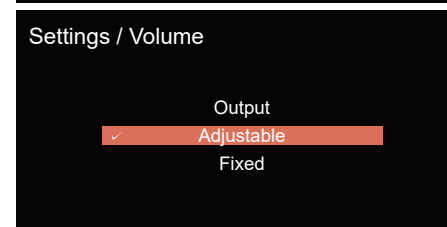
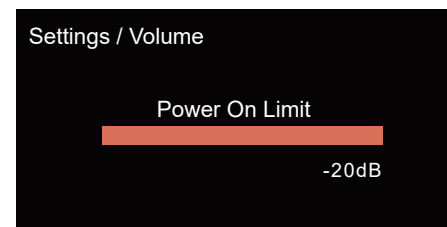

Display Options

The 9000N has different display modes (Home, Artwork A, Artwork B, VU Digital, VU Analogue, Audiolab logo & Display Off).

When 'off' is selected, press any key to turn on the display. The display will be revert to 'off' after 5 seconds of inactivity, by default. You can change the duration to 10, 15 and 30 seconds from the Display Time Out option in the menu.

Artwork A: On this option, the artwork cover is on the left, and the text is listed vertically from top to bottom on the right;

Artwork B: On this option, the artwork cover is on the top, and the text is listed on the bottom.

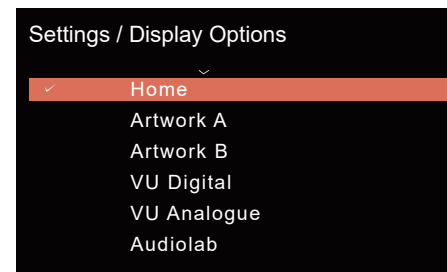

Display Settings

Brightness: Adjust the brightness of the 9000N front panel display.

Display Time Out: Adjust the time after which the 9000N display will revert to your chosen display option, from the home screen, after performing volume adjustments and other operations.

Animation: Turn display animations on or off.

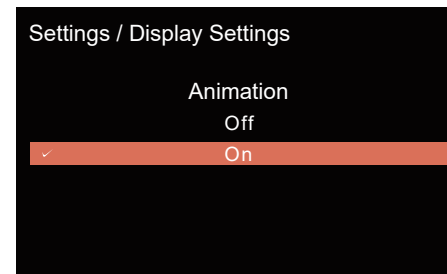
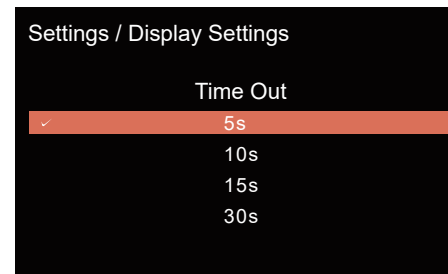
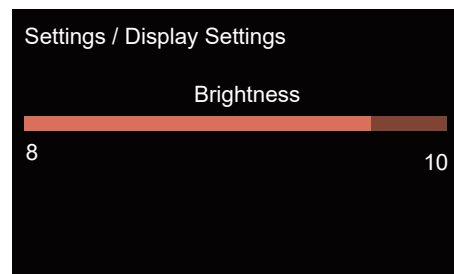
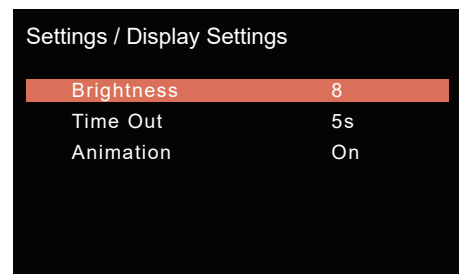

Trigger

Activate or deactivate the 12V trigger function of the 9000N.

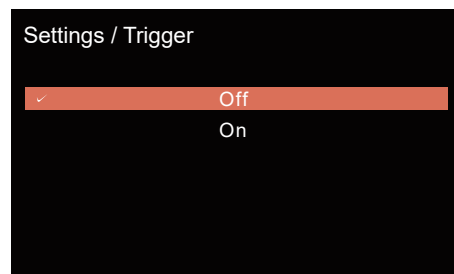

Standby

The auto standby feature will, by default, put the unit into standby after 20 minutes of inactivity.

This feature can be configured and set to 20 minutes, 60 minutes or Never.



Language

There are multiple different languages you can choose from to display your system so you can view information in your preferred language. The default language is English.



Reset

Reset the 9000N to the factory default settings.

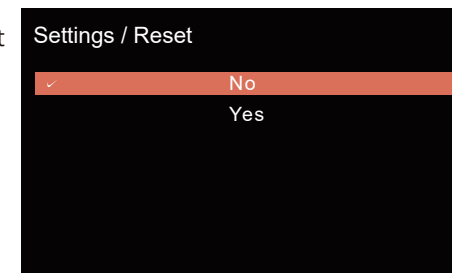

Info

Displays the installed firmware version and current Wi-Fi RSSI value.

Wi-Fi RSSI clarification:

The RSSI value is an indication of how well your 9000N can hear a signal from your access point or router.

Anything between -67dBm and -40dBm is ideal, and the closer the value to 0dBm, the better the wireless streaming performance.

- ≤-90dBm: Signal is very weak and unusable. Use a wired connection if possible.
- <-70dBm: Signal is weak, and streaming may be unreliable. Use a wired connection if possible.
- -67dBm: The minimum threshold for reliable streaming. Anything above this is very good.
- -30dBm: Excellent signal, and rarely achieved unless the client device (9000N) is right next to the Access Point (Wi-Fi router).

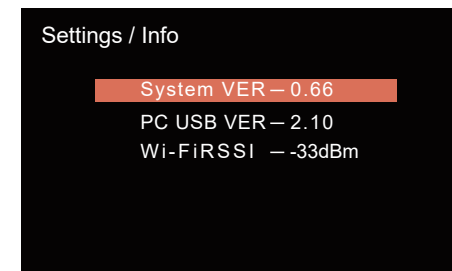

Switching On and Off

The 9000N should be switched on before the amplification stage in your system. When switching off your system, turn off the amplifier stage before switching off the 9000N.

Standby Mode

After initial power on, the 9000N will be in 'Standby' mode. To use the 9000N, press the 'Standby' button to bring the 9000N out of standby. The power indicator LED will become brighter and the display will show the 'Audiolab' welcome screen as the unit enters the operational mode.

Note: If using the remote control in conjunction with other 9000 series components, pressing STANDBY will put all 9000 series components in and out of standby simultaneously.

Source Select

Rotate the SELECT knob on the front panel or use the source (▼ or ▲) buttons on the remote handset to select different source inputs.

Volume Control

Rotate the VOL knob on the front panel, or use the Volume up/ down keys on the remote control, to set the volume level. The range is -78dB to 0dB, the factory default volume setting is -30dB. When coming out of standby the 9000N will be set to the previous used volume setting, except if louder than -20dB, in which case the volume will default to -20dB. You can change the limit, please see the Menu options for the Power On Limit feature.

Note: Volume adjustment only works under analogue output conditions. The digital output is constant.

If connecting to the pre-amp section of an external integrated amplifier, the analogue outputs can also be set to fixed 0dB. See the notes on page 10, Volume/Output.

Mute

Press the VOL knob on the front panel or MUTE button on the remote handset to mute / un-mute the sound.

Firmware Update

The streaming module updates 'Over The Air' (OTA). The Audiolab 9000N will check and ask for permission to apply updates when a new version is available. We recommend allowing latest updates to apply, as soon as they are available.

For MCU firmware updates please visit audiolab.co.uk to find the latest version. Please read the update instruction before commencing any update.

Install the Audiolab 9000N APP

Download the Audiolab 9000N App to your smart phone or tablet, from Google Play or App Store by scanning the QR code.



Enter the Audiolab 9000N application and navigate to the settings (denoted by the cog icon). Navigate to the bottom of the settings menu and select "Wi-Fi setup". Your smart device will search for the AP Hotspot. Please click "connect" and enter your Wi-Fi network password. After a few seconds, the 9000N will show a RED Wi-Fi icon on the GUI display to indicate a successful connection.

Note: After the 9000N has connected to the Wi-Fi network, your smartphone or tablet device may connect to another Wi-Fi network, if there're more than one Wi-Fi connection available. The Audiolab 9000N app will remain on the connection page but to access full functionality, simply connect your smartphone or tablet to the same Wi-Fi (original) network to which the 9000N is configured. Full functionality will be restored in an instant.

Ethernet Mode

Connect the 9000N to your router's RJ45 port by Ethernet cable, directly. Power on the 9000N unit and select the 'Streaming' source mode. The 9000N will connect to the Internet. Successful connection is denoted by the appearance of Ethernet icon on the 9000N GUI display.

Wi-Fi Mode

Via WPS

Check that your wireless router offers WPS mode and there is a WPS button on your router. If your router supports WPS mode, short press the WPS button on the rear panel of the 9000N. Then press the WPS button on your router. After a few seconds, the 9000N will show a RED Wi-Fi icon to denote successful connection.

In case of unsuccessful pairing, we recommend attempting these steps again. Or, depending on your router, it may be required to press WPS mode on the router, then press WPS on the 9000N.

Via AP Mode

Download the Audiolab 9000N app to your smart device and connect that device to your Wi-Fi network (the same network that you will use for the 9000N streaming functionality).

Long press the WPS button on the 9000N rear panel for 6 seconds. The 9000N display will show "Entering AP mode". After a few seconds, it will update to "AP mode" to indicate AP mode is activated.

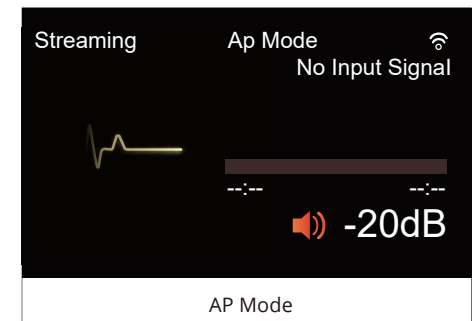
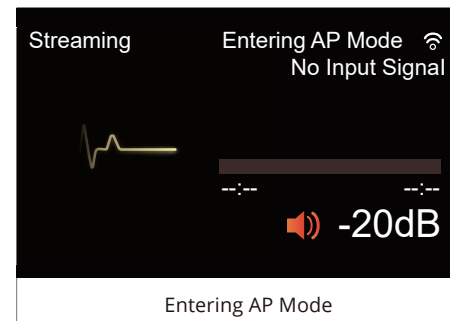

After connecting to the internet, in the options menu of the settings page, you can rename your 9000N, log in to Tidal/Spotify/Qobuz/Tuneln, turn on or turn off Ethernet LEDs and switch on or switch off Roon Ready.

You can also change the setting for checking for new firmware versions. The default setting is "Yes", to always check for firmware updates automatically.

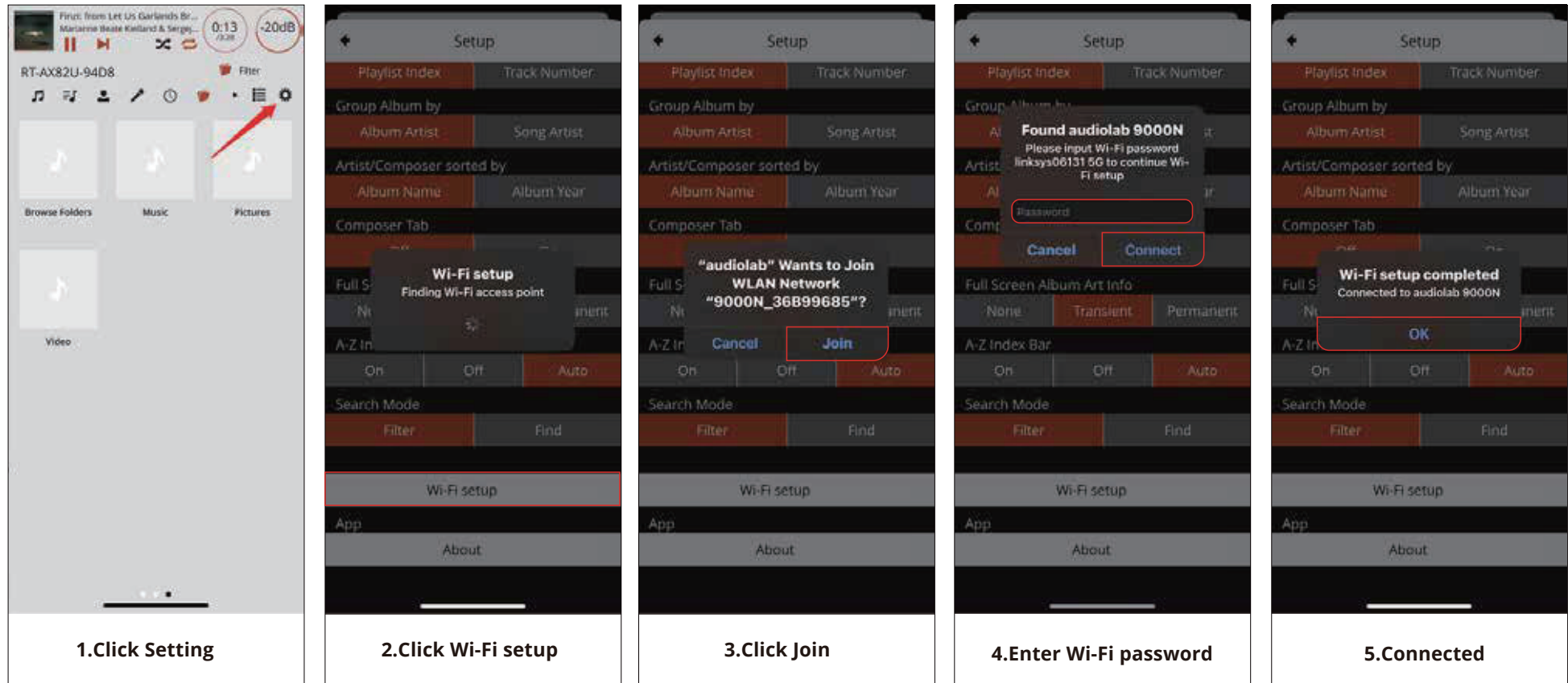

Connection example

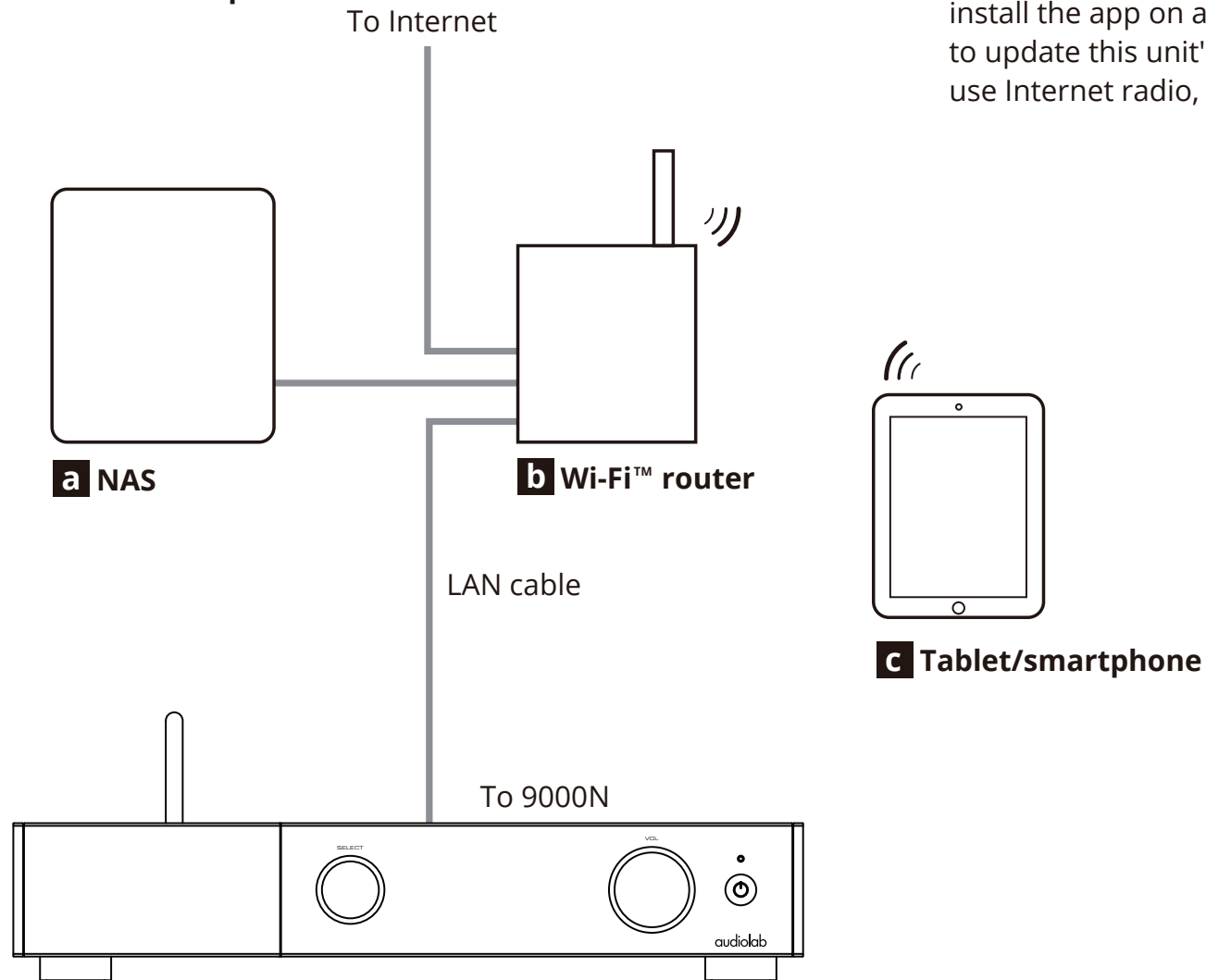

- An Internet connection is necessary to install the app on a tablet or smartphone to update this unit's NET firmware and to use Internet radio, for example.

Play/Pause

Press the **▶||** on the remote handset or long press the SELECT knob to play the music on the playlist. Press the button on remote handset or long press the SELECT knob again to pause the playback.

Previous/Next track

For Streaming control: Skip back to the start of current track by pressing **◀◀** button once. Skip back to previous track by pressing **◀◀** button twice. Skip forward to next track by pressing **▶▶** button once.

For PC USB control: Skip back to previous track by pressing **◀◀** button once. Skip forward to next track by pressing **▶▶** button once.

Playback via PC USB input

USB DRIVERS

Download the Windows PC USB Driver from audiolab.co.uk

Full instructions and details of operation are provided with the PC USB driver download.

Connect your computer to 9000N via USB cable (type A to Type B) and select PC USB source using the handset or the SELECT button on the front panel.

“No Input Signal” will be displayed if there is no input signal to the USB input. When you play a file the digital inputs will lock onto the digital signal as soon as there is an input signal for USB. The display screen will then show the output sampling frequency of the music file from your computer

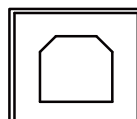

USB

Playback via USB Storage

Insert your USB disk with supported track files to the USB-A, which is located next to the Ethernet port on the rear panel. Locate the ‘Music Library’ in the settings page of the Audiolab 9000N app.

The USB Storage library will be named as XXXXX USB Music Server (XXXX is the corresponding name of your 9000N).

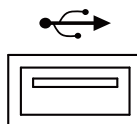

(5V= 1A)

Supported file formats include: FLAC, Apple Lossless (ALAC), WAV, AIFF, MQA, DSF, DSDIFF (DFF), DoP, MP3, ACC

Compatible Drive specifications

The 9000N is compatible with a variety of USB disks. They are required to be: Single-partition only, FAT32, exFAT and NTFS format only, Size: Max 4TB is recommended. Depending on the model and make, up to 8TB is possible but not guaranteed due to individual drive specifications.

Drive types

Most standalone flash drives are compatible with 9000N out of the box, including Flash drives / Thumb drives / Memory sticks / Pen drives (all often arriving formatted FAT32). If you are reformatting, please ensure that the drive is single-partition and formatted FAT32, exFAT and NTFS only.

USB-powered portable disks: Lightweight, portable, low-powered USB disks (often arriving formatted NTFS) are frequently compatible with 9000N. Some, however, do require more power than 9000N can provide over USB.

Portable USB disks with their own power supply: Dedicated 'desktop' USB disks with their own power supply are commonly compatible with 9000N. Some, however, are actually SATA disk enclosures, and we have found these to be more problematic.

Adapters and Enclosures: USB HDD enclosures (containing a SATA disk) and SD / Compact Flash / TF / etc adapters are not normally compatible with 9000N.

Playback via Network Connection

The 9000N supports local NAS/USB Storage and multiple-streaming services (Qobuz, Tidal, Spotify and TuneIn). It also supports standard UPnP connection, Spotify Connect and Tidal Connect. You can also manage your media via ROON since the 9000N has ROON READY certification.

NAS/UPnP

Connect your NAS (FAT32, exFAT or NTFS) to the same router as the 9000N. The NAS will be identified as a Music Library. You can manage your music media with the Roon app or by playing the tracks on the NAS directly from within the 9000N app.

Supported file formats include: FLAC, Apple Lossless (ALAC), WAV, AIFF, MQA, DSF, DSDIFF (DFF), DoP, MP3, ACC.

You can browse and sort files by track name/album/artist/genre/time in the Audiolab app, as well as add folders to playlists and save new playlist compilations.

Music Streaming Services

The 9000N supports Spotify, Tidal, Qobuz and TunesIn. You can log into your account in the Audiolab 9000N APP and access your music, create playlists and search / filter files with ease using the in-app functionality.

The 9000N also supports Spotify Connect and Tidal Connect meaning it can be selected as a 'speaker' or output source from within the native streaming service app.

Home Screen

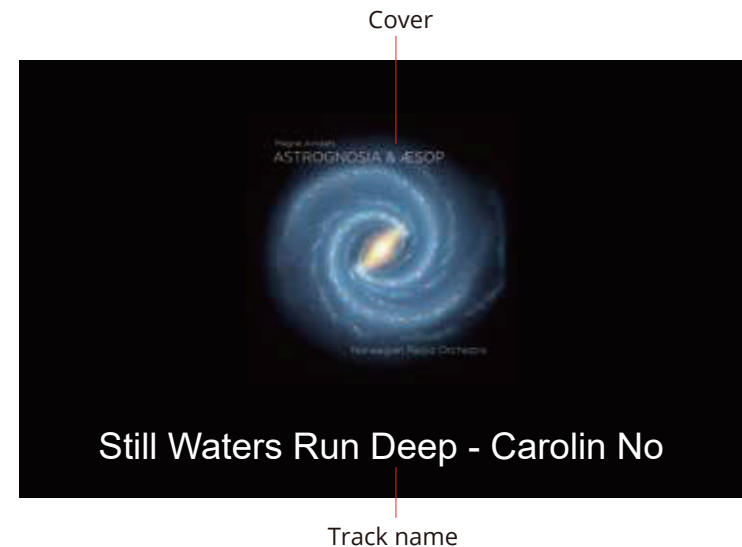
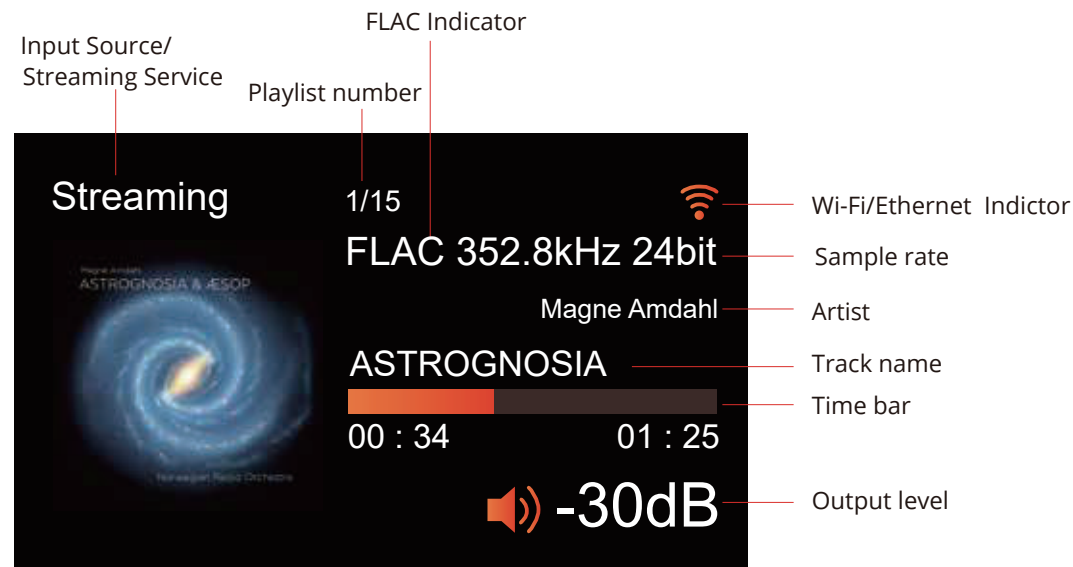

Audiolab Ltd. warrants this product, subject to the terms and conditions below, to be free from defects in materials and workmanship. During the warranty period Audiolab will repair or replace (at Audiolab's option) this product, or any defective part in this product, if it is found to be defective due to faulty materials, workmanship or function. The warranty period may vary from country to country.

Online Registration



Scan the QR code using a smart-phone device, for product warranty registration online.

The three (3) year extended warranty is applicable to items purchased from Jan 1st 2021, onwards. Items purchased prior to this date are not eligible for this extended warranty service but are subject to statutory warranty claims and all applicable consumer rights.

To qualify for the extended 3 year warranty, you must register your product within ninety (90) calendar days from the date of purchase. Visit audiolab.co.uk/warranty-registration to complete your online registration. Items not registered online will have a Limited Warranty for one (1) year, or for the period of your country's statutory warranty, whichever is longer.

Warranty can only be offered to products registered with proof of purchase with date, model and details of the authorised dealer clearly stated on the receipt/invoice. Please keep the original receipt/invoice in case it is required for a warranty claim.

This Limited Warranty is non-transferable and is offered exclusively to the original owner.

This Limited Warranty is valid only in the original country of purchase.

Repairs or replacements are provided under this warranty are the exclusive remedy of the consumer. Audiolab shall not be liable for any incidental or consequential damages for breach of any expenses or implied warranty with any product. Except to the extent prohibited by law, this warranty is exclusive and in lieu of all other warranties whatsoever, both expressed and implied, including but not limited to the warrant of merchantability and fitness for practical purpose.

This warranty provides benefits that are additional to and do not affect your statutory consumer rights.

This Limited Warranty offer is subject to correct information being submitted in your

application. Incorrect dates or mismatched purchase receipt dates that are outside of the warranty terms will immediately invalidate any warranty claim.

*Please check with your dealer local distributor for further information.

Exclusions

The following items are excluded from the Audiolab warranty:

Normal wear and tear and cosmetic damage (including but not limited to any wear from reasonable use, environmental deterioration or neglect)

Products on which the serial number has been removed, altered or otherwise made illegible.

Products not purchased from an authorised Audiolab dealer.

Products that were not new at the time of original purchase.

Products sold 'as is', 'as seen' or 'with faults'

Product not purchased from an Authorised Dealer/Distributor within the region of the claim (ie parallel imports or grey market products)

Accidental damage or faults caused by commercial use, acts of God, incorrect installation, incorrect connection, incorrect packaging, misuse or careless operation or handling which is not in accordance with the user instructions.

Equipment that has been operated in conjunction with unsuitable, inappropriate or faulty apparatus.

Repairs, alterations or modifications carried out by parties other than Audiolab or its authorised service partners.

Damage in transit that cannot be attributable to the fault of Audiolab, the authorised distributor or dealer (ie. claims otherwise covered by transit insurance.)

Faults relating to abnormal or inappropriate power supply voltage or power surges.

Faults relating to extremities in temperature, exposure to heat, water or other liquids, insects, excessive moisture, sand, chemicals, battery leakage or any other contaminants.

Any force majeure events, including but not limited to any acts of God, fire, lightning, typhoon, storm, earthquake, hurricane, natural disaster, tsunami, flood, war, riot, public disturbance.

Any other causes beyond the reasonable control of either Audiolab and its Authorised Distributor.

Please note items purchased before 1st Jan 2021 are not eligible for the extended warranty claim.

How to claim

To obtain warranty service please contact the authorised dealer from which you purchased this product and present the limited warranty certificate offered upon registration of your product's extended warranty offer.

Do not dispatch goods without the prior agreement of the dealer distributor or authorised service centre.

If asked to return products for inspection and or repair, please pack carefully preferably in the original carton or packaging affording an equal degree of protection and returned via insured, trackable courier service.

The authorised dealer or distributor will offer full return details and instructions. However, please note if unsuitable packaging is used the warranty may be deemed void due to improper action in return.

Audiolab or the authorised distributor, dealer or service centre may make a charge for the supply of new packaging for the return of the repaired item. Please note, insurance is recommended as goods are returned at the owner's risk. Authorised distributors or service centres cannot be held liable for loss or damage in transit. Insurance and freight charges on the return journey will be paid for by Audiolab, authorised dealer, distributor or service centre if corrective work proves to be necessary.

In the event of 'no-fault found' or 'no repair necessary', the return shipping charge will be the responsibility of the owner.

Repairs

All repairs will be carried out by the appointed distributor (or locally appointed service centre). Repairs handled or processed without authorisation or approval of the appointed representative will be excluded from this limited warranty. Please note, Audiolab is not able to supply parts or replacement items to any other entity than the official distributor or authorised service centre.

Other than the warranty and services set out in this warranty, to the fullest extent permitted by law, Audiolab shall not be liable to you and/or any third party or entity whatsoever for:

- Any loss, damages and/or malfunction caused to any product(s) which is/are connected to any of the products covered by this warranty.
- Any damages, loss and liability, whether direct, indirect, incidental, consequential special, punitive or otherwise, howsoever caused by, arising out of or otherwise, in relation to the installation, delivery, use, service, repair, replacement and/or maintenance of the product;
- Any damages, loss and liability under this warranty in respect of any act, omission, or negligence of any of their technicians, employees, agents, representatives or independent contractors relating to the actual or purported performance of any of the obligations under this warranty.

Service Centre Address

Should a fault occur with your product, please pack it correctly using the original packing, so you can ship it safely. For technical support, servicing or product queries and information, please contact either your local retailer or the office below:

IAG Service Dept.
13/14 Glebe Road
Huntingdon
Cambridgeshire
PE29 7DL
UK

Tel: +44(0)1480 452561
Email: service@audiolab.co.uk

For information on other authorised service centres worldwide contact Audiolab International, UK.

A worldwide distributors list is available on the Audiolab website: www.audiolab.co.uk

BRAND	Audiolab
Model	9000N
General Description	Network Player
Design Philosophy And Core Technology	<p>ESS Sabre ES9038Pro 32bit DAC</p> <p>Quad Arm® Cortex®-A53 core,1.8GHz per Core</p> <p>Audiolab 9000N MUSIC Streaming technology (IEEE 802.11 a / b / g / n / ac,2.4/5GHz)</p> <p>UPnP AV protocol with audio streaming extension (Open Home)</p> <p>Built-in Certified MQA Full decoder (via streaming & PC USB)</p> <p>Native support for Spotify Connect, TIDAL Connect, MQA, Qobuz and TuneIn Radio</p> <p>Roon Ready</p> <p>Gapless Playback</p> <p>High-resolution album artwork display</p> <p>USB storage / flash drive / USB hard disk (Single-partition FAT32, exFAT and NTFS) playback</p> <p>4.3" (800 x 480px) IPS LCD screen</p> <p>iOS (11.0 or later) / Android (Android 4.0 or later) required for App control</p>
The audiolab 9000N App features	<p>Native support for TIDAL, MQA, Qobuz and TuneIn Radio</p> <p>Tidal MQA icons to easily identify high-res music</p> <p>Qobuz high-res icons to identify high-res music</p> <p>Volume control</p> <p>High-resolution album artwork display</p> <p>Artwork caching</p> <p>Intelligent search functionality</p> <p>Multiple Playlist complications & functionality</p> <p>Multiple tag handling</p> <p>Composer tag support</p> <p>Album-grouping in playlist</p> <p>Automatic internet links to artists / album / songs</p> <p>Saving and restoring of playlists (including Tidal and Qobuz)</p>
Inputs	<p>1 x Network Streaming</p> <p>1 x PC USB (USB Type-B)</p> <p>1 x Ethernet 10/100 / 1000 Base-T Ethernet</p> <p>1 x 12V Trigger</p>
Outputs	<p>1 x RCA (pair)</p> <p>1 x XLR (pair)</p> <p>1 x Optical</p> <p>1 x Coaxial</p> <p>1 x 12V Trigger (Link)</p>

Supported File Formats	DSD Lossless: DSF (DSD), DIFF (DSD), DoP (DSD) PCM Lossless: FLAC, Apple Lossless (ALAC), WAV, AIFF Compressed (lossy) Audio: MP3 MQA
Sampling Frequency	PCM: 44.1kHz-768kHz (705.6kHz / 768kHz Fixed-point supported via Music App streaming) DSD: DSD64, DSD128, DSD256, DSD512 (Native)
Digital Section	
Digital Output Voltage	500mV +/- 50mVpp
Output Impedance	75Ω
Frequency Response	-0.01dB (20Hz - 20kHz, ref.1kHz)
Max. Sampling Frequency	192kHz / 24bit
Digital Outputs	1 x Coaxial , 1 x Optical
D to A Converter	
Variable Output Voltage	0 – 2.05V
DAC	ES9038Pro
Frequency Response	+/-0.5dB (20Hz - 20kHz, ref.1kHz)
Total Harmonic Distortion	<0.001% (1kHz @ 2.05Vrms)
Max. Sampling Frequency	768kHz / 32bit
Signal-to-noise ratio (A-weighted)	>116dB(RCA), >120dB(XLR)
Output Impedance	120Ω
General	
Standby Power Consumption	<0.5W
Net Weight	6.2kg
Gross Weight	8kg
Dimensions (mm)(W x H x D)	444 x 89 x 333
Carton Size (mm)(W x H x D)	514 x 470 x 161
Finish	Black / Silver
Power Requirements (depending on region)	220-240V ~ 50/ 60Hz 100-120V ~50/ 60Hz
Safety Regulation Conformity	
Standard Accessories	Power Cord, Remote Control, User Manual

audiolab

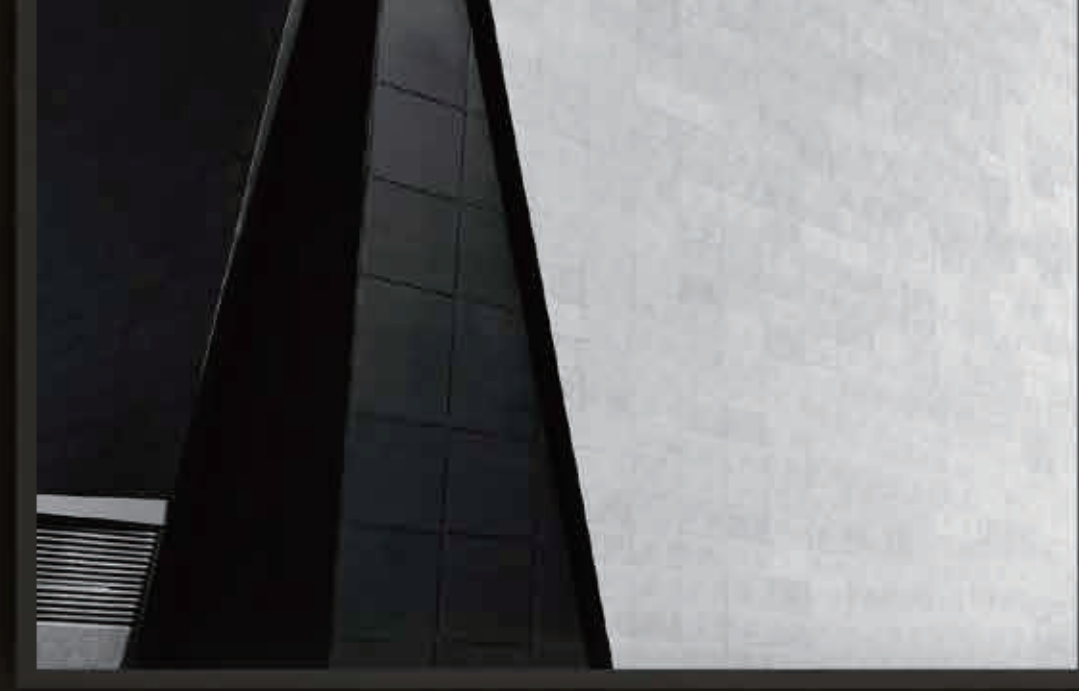

audiolab



Correct disposal of this product. This marking indicates that this product should not be disposed with other household wastes throughout the EU. To prevent possible harm to the environment or human health from uncontrolled waste disposal, recycle it responsibly to promote the sustainable reuse of material resources. To return your used device, please use the return and collection systems or contact the retailer where the product was purchased. They can take this product for environmental safe recycling.



Audiolab
IAG House,
13/14 Glebe Road,
Huntingdon,
Cambridgeshire,
PE29 7DL,
UK

Telephone: +44(0)1480 452561

Email: service@audiolab.co.uk

<http://www.audiolab.co.uk>