

INTEGRATED AMPLIFIER 6000A Play User Manual

audiolab

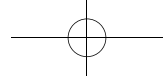

1: Important Safety Information



This lightning flash with arrowhead symbol within an equilateral triangle is intended to alert the user to the presence of non-insulated “dangerous voltage” within the product’s enclosure that may be of sufficient magnitude to constitute a risk of electric shock.

Warning: To reduce the risk of electric shock, do not remove cover (or back) as there are no user-serviceable parts inside. Refer servicing to qualified personnel.

The exclamation point within an equilateral triangle is intended to alert the user to the presence of important operating and maintenance instructions in the literature accompanying the appliance.

IMPORTANT SAFETY INSTRUCTION

Read these instructions.

Keep these instructions.

Heed all warnings.

Follow all instructions.

Do not use this apparatus near water.

Clean only with dry cloth.

Do not block any ventilation openings. Install in accordance with the manufacturer’s instructions.

Do not install near any heat sources such as radiators, heat registers, stoves, or other apparatus (including amplifiers) that produce heat.

Do not defeat the safety purpose of the polarized or grounding-type plug. A polarized plug has two blades with one wider than the other. A grounding plug has two blades and a third grounding prong. The wide blade or the third prong is provided for your safety. If the provided plug does not fit into your outlet, consult an electrician for replacement of the obsolete outlet.

Protect the power cord from being walked on or pinched particularly at the plugs, convenience receptacles, and at the point where they exit from the apparatus.

Unplug this apparatus during lightning storms or when unused for long periods of time.

Refer all servicing to qualified service personnel. Servicing is required when the apparatus has been damaged in any way, such as power supply cord or plug is damaged, liquid has been spilled or objects have fallen into the apparatus, the apparatus has been exposed to rain or moisture, does not operate normally, or has been dropped.

CAUTION: These servicing instructions are for use by qualified service personnel only. To reduce the risk of electric shock, do not perform any servicing other than that contained in the operating instructions unless you are qualified to do so.

Do not install this equipment in a confined or built-in space such as a bookcase or similar unit, and keep well ventilated in open space. The ventilation should not be impeded by covering the ventilation openings with items such as newspaper, table-cloths, curtains etc.

WARNING: Only use attachments/accessories specified or provided by the manufacturer (such as the exclusive supply adapter).

WARNING: Please refer to the information on the exterior panel of the enclosure for electrical and safety information before installing or operating the apparatus.

WARNING: To reduce the risk of fire or electric shock, do not expose this apparatus to rain or moisture. The apparatus shall not be exposed to dripping or splashing and that objects filled with liquids, such as vases, shall not be placed on apparatus.

WARNING: For the terminals marked with symbol of “⚡” the voltage may be of sufficient magnitude to constitute a risk of electric shock. The external wiring connected to the terminals requires installation by a qualified person or the use of ready-made leads or cords.

The product is designed to use in moderate/tropical climates.

Mains Supply: The mains operating voltage of Audiolab 6000 series units is shown on the rear panel. If this voltage does not match the mains voltage in your area, consult your Audiolab dealer about converting the unit.

The mains supply fuse on the rear panel is accessible when the IEC mains plug has been removed. In the rare event that it has broken, check for any obvious cause before replacing the fuse with one of the correct rating and type.

The fuse values are:

220 – 240V (UK, China, etc.) T2AL 250V Slow Blow

100 – 120V (USA, Japan, etc.) T4AL 250V Slow Blow



This equipment is a Class II or double insulated electrical appliance. It has been designed in such a way that it does not require a safety connection to electrical earth.

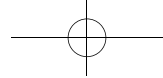

2: Contents

audiolab
6000A Play

GETTING STARTED4

CONTROLS AND FUNCTIONS5

REMOTE HANDSET6

CONNECTIONS7

SYSTEM OPERATIONS8

DTS PLAY-FI® WIRELESS STREAMING TECHNOLOGY11

DOWNLOAD THE APP12

WI-FI CONNECTION USING THE APP13

WI-FI CONNECTION SETUP USING A WINDOWS PC OR MAC14

APP OPERATIONS15

WARRANTY19

SPECIFICATIONS20

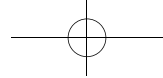

3: Getting Started

Page 4

Introduction to Audiolab 6000 Series

Welcome to the Audiolab 6000A Play, an integrated amplifier with wireless audio streaming, which is the latest member of the acclaimed Audiolab 6000 series of components. Featuring DTS Play-Fi Technology, music can be streamed over your wireless network in high resolution format and can be easily expanded to a multi-room system if required. You can stream from any source on your wireless network, including smart-phones, tablets or PCs as well as a NAS Drive. However you want to stream your music, Audiolab's 6000A Play will deliver an outstanding performance.

The 6000A Play features analogue and digital audio circuitry of the highest quality and has been designed by engineers who are passionate about the reproduction of music, and we hope you will enjoy its performance for many years to come.

Please read through this manual to obtain the very best performance from your 6000A Play.

Features:

- DAC - ES9018K2M
- Dedicated high performance MM phono input
- Separate pre-power sections for flexibility of operation
- Automatic equipment activation via 12V trigger
- Auto standby function
- Wireless audio streaming with DTS Play-Fi technology
- Bluetooth aptX receiver

Inputs:

- Three analogue line level inputs
- One phono input (MM)
- One power-amp input
- Two coaxial SPDIF digital inputs
- Two optical SPDIF digital inputs

Outputs:

- Pre-amplifier output
- Loudspeaker output
- Headphone output

Unpacking The Equipment

The carton should contain:

- The Audiolab 6000A Play
- One IEC power cord suitable for your area
- One remote handset
- One instruction manual

Please note: The remote control requires 2 x AAA type batteries. Due to international shipping and courier regulations with Lithium Ion batteries, the remote controller battery is not included in this package.

Consult the dealer from whom you purchased the equipment if any item is not present. Carefully unpack the unit and accessories. Take care not to damage the surface finish when undoing the protective polythene sleeve. Retain the packing materials for future use. Retain the user manual and information concerning the date and place of purchase of your equipment for future reference. If you transfer the unit to a third party please pass on this instruction manual along with the equipment.

Placement

The unit must be mounted on a solid, level and stable surface.

Before you connect the Audiolab 6000A Play to the AC mains power, ensure your AC mains voltage corresponds to the rating on the rear panel of the product. If in doubt, consult your dealer. If you move to an area which has a different mains voltage, seek advice from an Audiolab appointed dealer or a competent service technician.

4: Controls and Functions

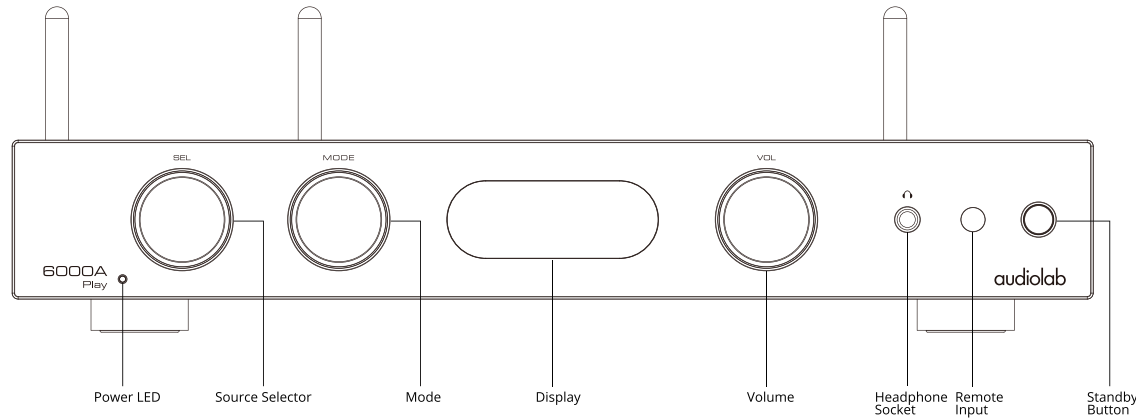

Device States	WiFi LED States(red)	Power LED States
Standby Mode	Off	Dark red
Initialization Mode	Fast flash	Fast flash white
Standard Setting Mode	Slow breathe	Slow breathe white
WPS Mode	Double flash	Double flash
Network Connecting	Slow flash	Slow flash white
WiFi Network Connection	Brightly lit	Bright white
Wired Network Connection	Off	Bright red

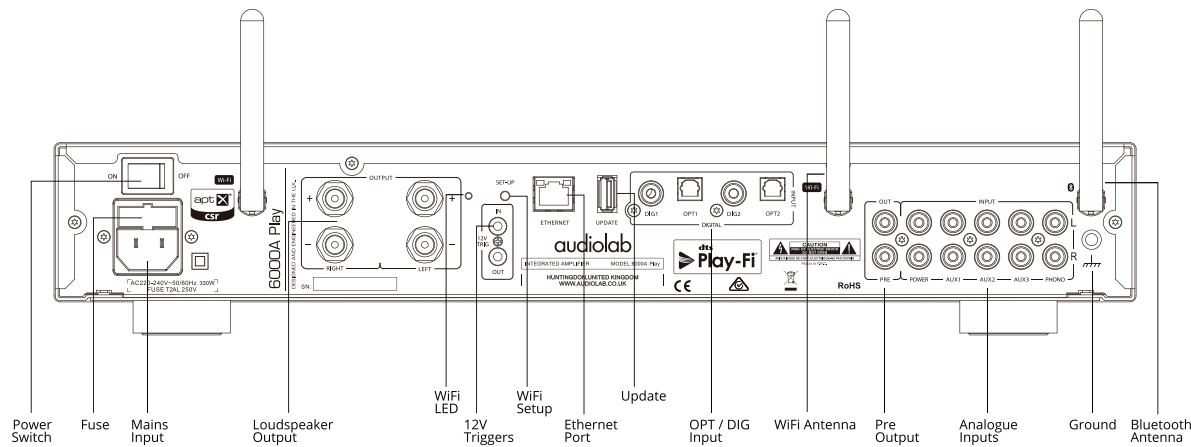

5: Remote Handset

NOTE : the handset buttons shown crossed out are for use with other Audiolab units like Audiolab 6000CDT and are not operational when used with the 6000A Play

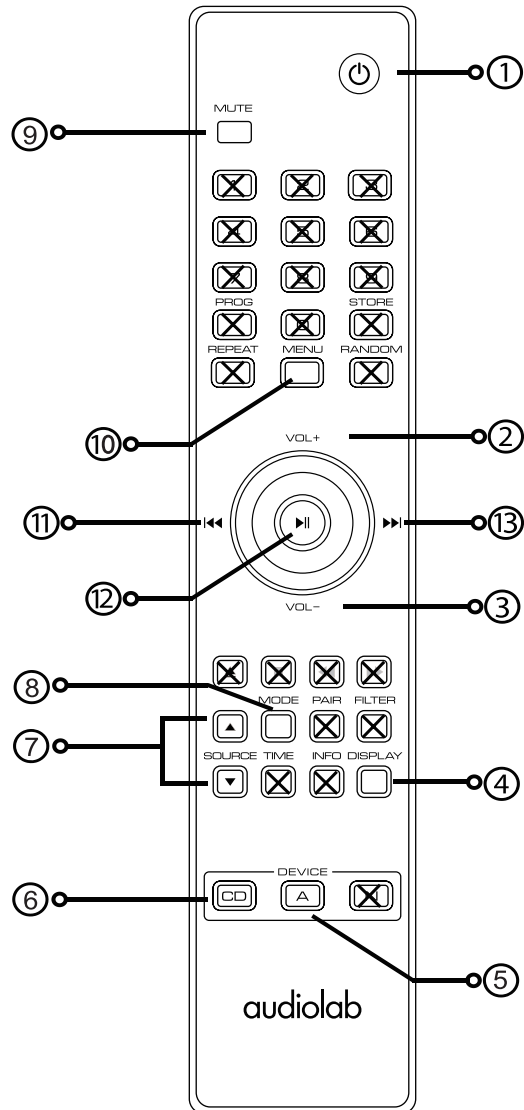

- 1 STANDBY Press to bring the unit in/out of standby
- 2 VOL+ Increase volume
- 3 VOL- Decrease volume
- 4 DISPLAY Press to toggle the display on/off
- 5 A Press to select 6000A Play remote mode
- 6 CD Press to select 6000CDT remote mode
- 7 SOURCE Press to cycle source inputs
- 8 MODE Press to select 6000A Play operating mode
- 9 MUTE Press to mute and unmute the sound
- 10 MENU Press to enter menu
- 11 ◀◀ Move to the previous track
- 12 ▶▶ Move to the previous page or setting in menu
- 13 ▶▶ Press to start / pause
- Press to confirm page or setting selected in menu
- Press and hold to disconnect the Bluetooth
- 13 ▶▶ Move to the next track
- Move to the next page or setting in menu

Fitting Batteries

The remote control requires 2 x AAA type batteries. Due to international shipping and courier regulations with Lithium Ion batteries, the remote controller batteries are not included in this package.

Always use AAA batteries and replace them in sets -never mix old and new batteries.

Handset Operation

The handset operates several Audiolab components. The handset buttons shown crossed out are for use with other Audiolab units and are not operational when used with the 6000A Play.

Point the handset at the remote receiver and press the relevant key. The handset should be within 15 meters of the player and there must be a clear line of sight between the two units.

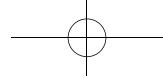

6: Connections

Analogue Inputs (Line Level)

Connect your analogue sources to one of the three line level inputs, AUX1, AUX2 or AUX3.

Phono Input (MM)

Connect your turntable (moving magnet cartridge) to the phono input. Connect the Earth lead from your turntable (if available) to the GROUND terminal.

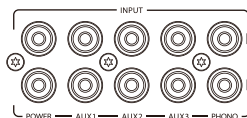

Coaxial Digital Inputs

Connect your coaxial digital sources to either DIG1 or DIG2.

Optical Digital Inputs

Connect your optical digital sources to either OPT1 or OPT2.



Pre-Amplifier Output

Pre-amplifier output for driving external power amplifiers, subwoofers or signal processors.

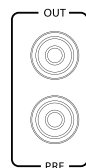

Loudspeaker Terminals

One set of loudspeaker output terminals.

Headphone Output

A stereo 6.3mm (1/4") jack is provided on the front panel for connecting headphones.

When headphones are connected the audio to the loudspeakers terminals will be cut off.

Bluetooth Connection

Select BT source on the 6000A Play, on your mobile device search for 'Audiolab 6000A Play BT' and connect.

Once paired the front panel SOURCE indicator will be turned on. If you switch to another input on the 6000A Play your mobile device will be disconnected after 60 sec. To reconnect, select BT on the 6000A Play and it will connect to the last paired device, or select 'Audiolab 6000A Play BT' on your mobile device in the Bluetooth menu and it will reconnect.

USB Update

Put the update file into USB drive, plug in the UPDATE USB interface, press STANDBY button on the front panel then POWER ON, 6000A Play will upgrade automatically. After the completion, unplug the USB drive and restart the device, now it can be used.



ETHNERNET Port

Use a suitable cable to plug the Ethernet Port to the LAN port of a wireless router for wired connection. It is recommended to use a wired connection when playing high resolution audio, which makes the playback more stable and smooth.

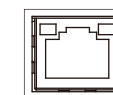

12V Trigger Connections

The 6000A Play features two 12V trigger connections, one output and one input. Use the output to control other products (ie. Audiolab amplifiers or 3rd party compatible equipment). Use the input when the 6000A Play is to be controlled (ie. by Audiolab 6000CDT, or 3rd party compatible equipment).

The trigger connections are made using 3.5mm to 3.5mm jack interconnects (not incl.).

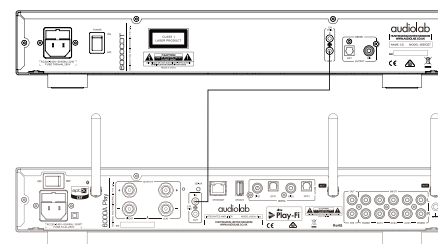

Mains Input

Before connecting the AC power cord to the 6000A Play, please make sure the Power Switch is in the OFF position. Switch it to the ON position after connecting the unit to the AC mains.

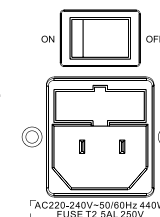

AC220-240V-50/60Hz 440W FUSE T2.5AL 250V

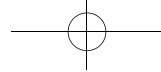

7: System Operations - 1

Switching On and Off

Switch on all source units before switching on power to the 6000A Play.

When switching On: the power LED illuminates.

When switching Off: switch off the 6000A Play before the source units.

Standby Mode

The 6000A Play will enter standby mode after being powered on. Press the "Standby" button to bring the 6000A Play out of standby, the power indicator LED becomes brighter and the display shows "6000AP" welcome screen while the unit is getting ready for operation.

The Auto Standby feature will, by default, put the unit into standby after 20min of inactivity.

This feature can be configured using the MENU (see page 8) and can be set to 20 minutes , 1 hour or Never.

Source Select

Rotate the SEL knob on the front panel or use the source buttons on the remote handset to select different source inputs.

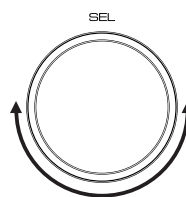

Volume Control

Rotate the VOL knob on the front panel, or use the Volume up/down keys on the remote control, to set the volume level. The range is -78dB to +8dB, the factory default volume setting is -20dB. When coming out of standby the 6000A Play will be set to the previous used volume setting, except if louder than -30dB, in which case the volume will default to -20dB.

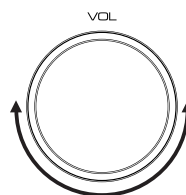

Mute

Press the VOL knob on the front panel or the MUTE button on the remote handset to mute / un-mute the sound.

Display Setting

The DISPLAY button on the remote control will toggle the front panel display ON/ OFF.

When the display is OFF: using the front panel controls or pressing any remote key will momentarily turn on the display, after 5 seconds. the display will go off.

Digital Filter Selection (DAC)

The DAC in the 6000A Play has a choice of 3 digital filters. Press the MENU key on the remote control to access the FILTER options (see page 8 for further details)

- Filter = Fast : Standard flat response with fast frequency roll off above $F_s/2$ (half the sampling frequency)
- Filter = Slow: Starts rolling off at a lower frequency than the Fast filter but has a more gentle rate of attenuation.
- Filter = Phase: Has a gentle attenuation slope similar to the Slow filter but with minimum phase characteristics. It can be likened to an analogue filter applied in the digital domain.

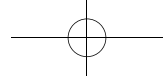

7: System Operations - 2

Operating Mode

Although the 6000A Play is an integrated amplifier it can function as a separate pre and power amplifier.

Use the MODE knob on the front panel, or the MODE key on the remote control, to select different operating modes.

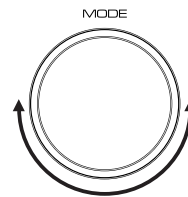

MODE	POWER AMP IN	PRE OUT	HEADPHONE OUT	LOUDSPEAKERS
PRE	DISABLE	ACTIVE	ACTIVE	DISABLE
PRE-POWER	ACTIVE	ACTIVE	ACTIVE	ACTIVE
INTEGRATED	DISABLE	ACTIVE	ACTIVE	ACTIVE

Integrated Mode

The pre-amplifier section is internally connected to the power amplifier, pre-amplifier output is also operational in this mode. A second power amplifier can be connected for bi-amplification as shown in the diagram.

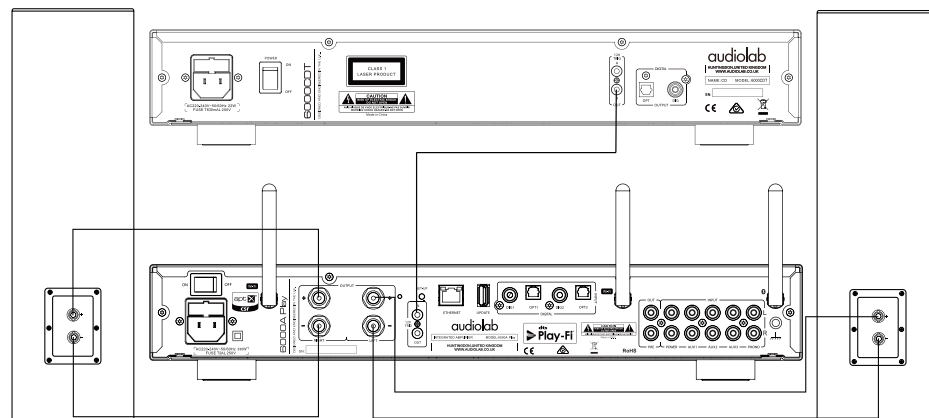

Pre-Power mode

The pre-amplifier section is internally disconnected from the power amplifier. The 6000A Play can be used as a stand alone power amplifier (ie. part of an AV setup). This mode can also be used if additional signal processing is required, connecting the pre-out to an external signal processor and then take the output from the processor to the 6000A Play Power-IN.

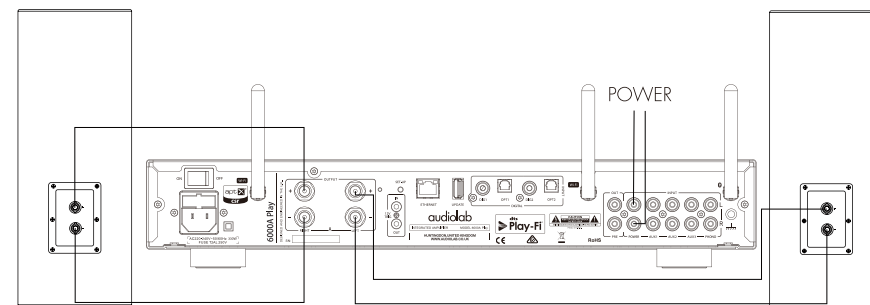

Pre Mode

All signals to and from the power amplifier of the 6000A Play are disconnected. In this mode, the 6000A Play functions as a stand-alone pre-amplifier. The pre-amplifier section of the 6000A Play can be connected to a stereo power amplifier, or to two mono-block amplifiers.

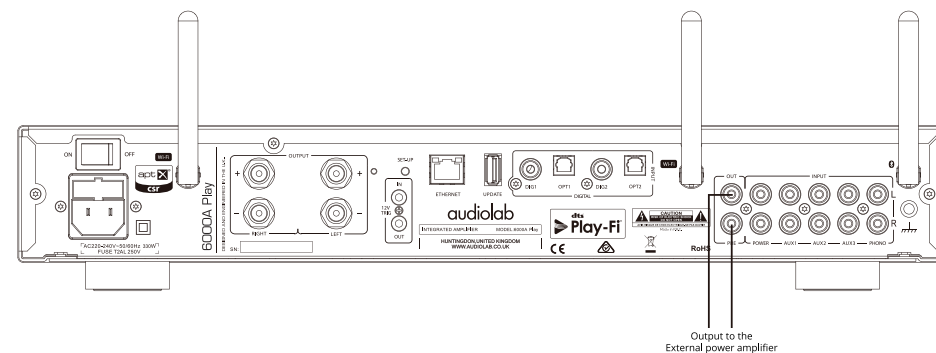

The MENU

The menu enables you to customize the unit and optimize the interface with other equipment in your system.

6000A Play has 8 different menu pages. Press the MENU key on the remote control to enter menu mode, and then press ◀◀ or ▶▶ to turn to different menu pages. Press ▶|| to enter any menu page, press ◀◀ or ▶▶ again to select different settings.

You can also press the MODE knob on the front panel to enter the menu mode. Pressing the MODE knob on the front panel can also enter the menu mode. Rotate this knob turns through the menu pages. Press the MODE knob again to enter any menu page and rotate the knob to change the setting. Press the MODE knob again to select a setting.

No operation for 5 seconds will also exit menu mode automatically.

The Menu Tree

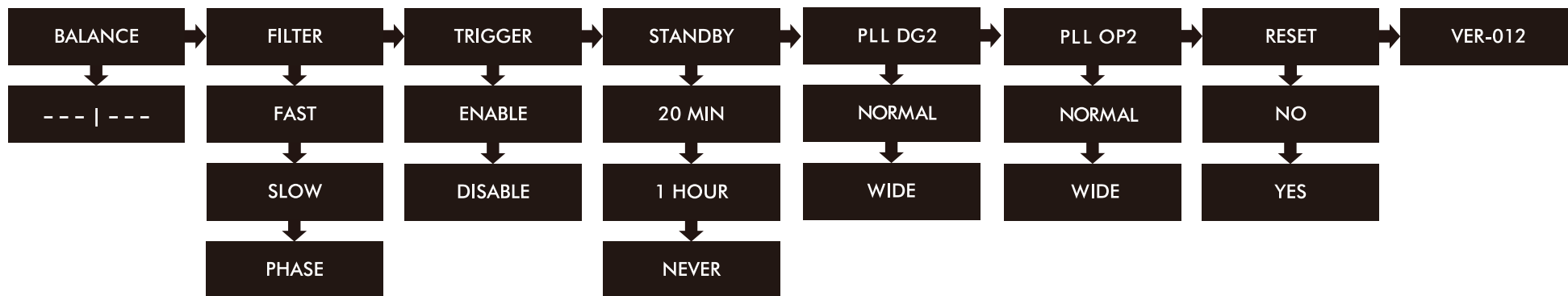

Key Features

DTS Play-Fi puts you in complete control of your music. It gives you the freedom to effortlessly stream via Wi-Fi® from any device to any speaker in any room in your house. It's never been easier to listen to music with the people you love, in the place you love most. A place where memories are made and music plays the starring role.



WI-FI® TECHNOLOGY

DTS Play-Fi streams music over standard Wi-Fi networks, delivering perfectly synchronized audio, with no lag and zero loss in sound quality.

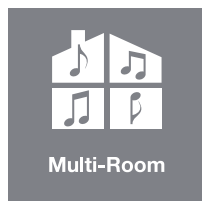

MULTI-ROOM

Enjoy music in every room of your house — all at once, perfectly synchronized, with no lag. You're in control.

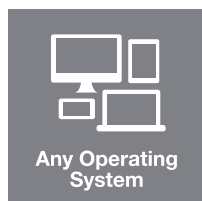

ANY OPERATING SYSTEM

Fully compatible with all operating systems: Apple iOS, Android™, Windows® PC, and Fire OS.

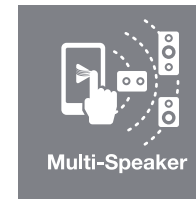

MULTI-SPEAKER

DTS Play-Fi is open to all speakers, no matter the size, shape, or brand. It's a truly all-inclusive system.

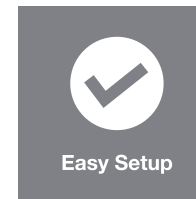

EASY SETUP

No logins, no complicated computer-based setups. Just download the app and within minutes, you're ready to listen.

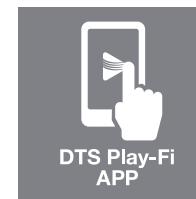

DTS PLAY-FI APP

Simply download the free app and immediately send songs via Wi-Fi to any speaker in any room of the house.

For DTS patents, see <http://patents.dts.com>. Manufactured under license from DTS Licensing Limited. DTS, Play-Fi, the Symbol, and Play-Fi together in combination with the Symbol are trademarks of DTS, Inc. DTS and Play-Fi are registered trademarks of DTS, Inc. © DTS, Inc. All Rights Reserved.

Download the DTS Play-Fi APP

The DTS Play-Fi APP can be downloaded from the Google Play Store, Amazon APP Market or Apple App Store. For Windows PC you can download the Play-Fi Windows APP from the official website: <https://play-fi.com>

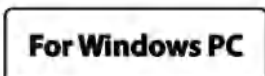

Network Settings

Wired network setting

Connect the Ethernet Port to the LAN port of a wireless router using a suitable cable. After switching on the 6000A Play, the white LED on the front panel and red Wi-Fi LED on the rear panel will fast-flash during the initialize phase of Wi-Fi mode. The LED change from white to red on the front panel and slow-flash when the device is connected to the wired network connection. If the connection is successful, the red Wi-Fi LED will go off, but the red LED on the front panel stays lit.

Wireless Network Setting

You can connect to a wireless network using one of two modes: WPS Mode or Standard Mode.

WPS Mode:

In order to make the 6000A Play enter WPS Mode, switch the unit on and press and hold the Wi-Fi SET-UP button on the rear panel for 4 seconds. The Wi-Fi LED will double-flash and beep with a warning tone indicating that WPS Mode is active. Then briefly press the WPS key on your wireless router and the unit should connect to your wireless network automatically. This connection phase may take up to 60 seconds. If the connection fails, please try again.

Standard Mode:

After switching the 6000A Play on, press and hold the Wi-Fi SET-UP button on the rear panel for 8 seconds. For the first 4 seconds the Wi-Fi LED will double-flash and beep with a warning tone - keep holding the button down and after 8 seconds the Wi-Fi LED will flash quickly and also beep with a warning tone. The Standard connection mode is now active and the Wi-Fi hotspot will be found after 20 seconds. Then the Wi-Fi LED will flash-breathe with a slow fluctuation between off and on (reflected by the white LED on the front panel). You can now use your Android or IOS device to enter the Wi-Fi password using the Play-Fi APP as follows (see next page):

10: Wi-Fi Connection Using the APP

For Andriod users:

- (1) Open the DTS Play-Fi APP, then click the 'Set-up your Play-Fi device' button.
- (2) When it has found the 6000A Play click the 'Set-Up' button. Next input the Wi-Fi password for your wireless network. Then click the 'Next' button.
- (3) During installation the APP will find and upgrade the 6000A Play-Fi settings which may take a few minutes.
- (4) After completing the network setup and upgrading you can set a name for your 6000A Play Device and use it.

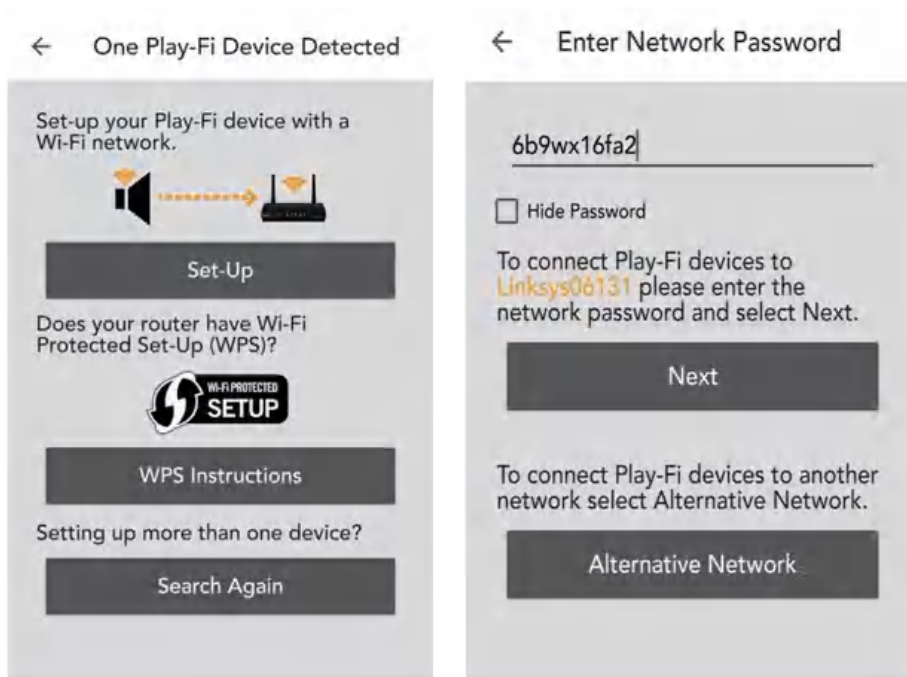

For Apple iOS users:

- (1) Download the Play-Fi APP. Before opening the APP please switch to the Settings - Wi-Fi menu on your smartphone or tablet and select 'PlayFiXDeviceXXXXXX' from the options.
- (2) Open the Play-Fi APP and find the 6000A Play-Fi Device name. Select it and enter your wireless network password.

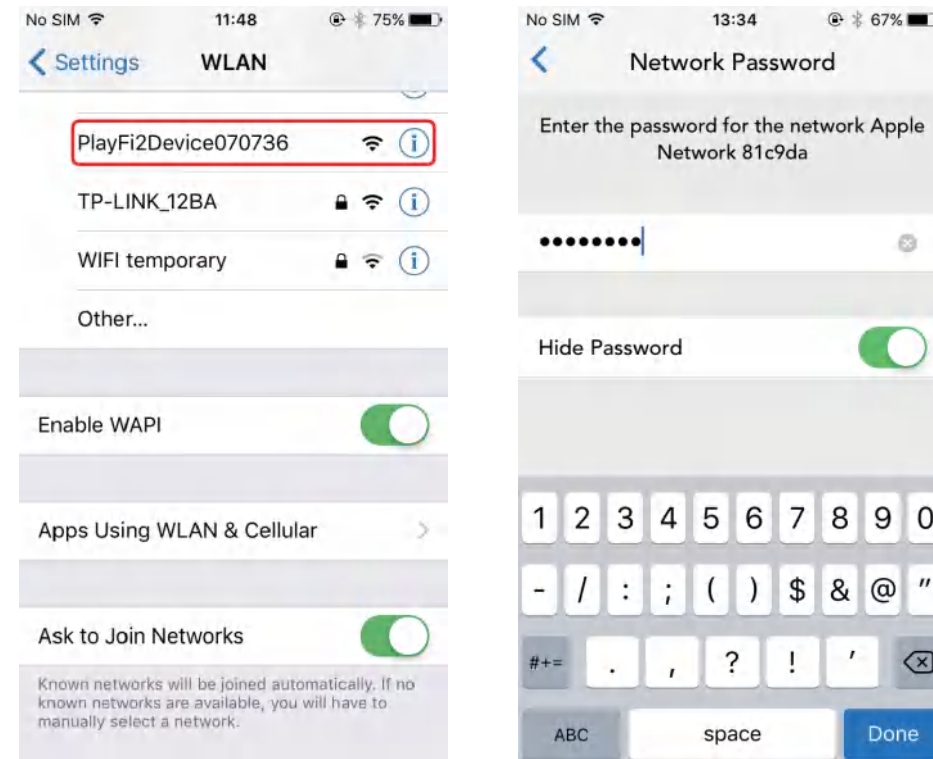

- (3) During installation the APP will find and upgrade the 6000A Play-Fi settings which may take a few minutes.
- (4) After completing the network setup and upgrading you can set a name for the 6000A Play Device and use it.