

FCC RADIO TEST REPORT

Applicant..... : Miura Systems Ltd
Address..... : Unit 3, Cliveden Office Village, Lancaster Road, Cressex Industrial Estate,
High Wycombe, HP12 3YZ, United Kingdom
Manufacturer..... : Miura Systems Ltd
Address..... : Unit 3, Cliveden Office Village, Lancaster Road, Cressex Industrial Estate,
High Wycombe, HP12 3YZ, United Kingdom
Factory..... : Jabil Vietnam Company Limited
Address..... : Lot I-8 SaiGon Hitech Park, Long Thanh My ward, Thu Duc city, Ho Chi Minh
city, Vietnam
Product Name.....: Mobile Point of Sales terminal
Brand Name.....: Miura Systems Ltd
Model No.: M021, M020 (For model difference refer to section 2.)
FCC ID.....: 2AO4FM020-2
Measurement Standard.....: 47 CFR FCC Part 15, Subpart C (Section 15.247)
Receipt Date of Samples..... : April 24, 2023
Date of Tested.....: April 24, 2023 to May 25, 2023
Date of Report.....: June 29, 2023

This report shows that above equipment is technically compliant with the requirements of the standards above. All test results in this report apply only to the tested sample(s). Without prior written approval of Dongguan Nore Testing Center Co., Ltd, this report shall not be reproduced except in full.



Prepared by

Rose Hu / Project Engineer



Approved by

Iori Fan / Authorized Signatory

Table of Contents

1. Summary of Test Result	4
2. General Description of EUT	5
3. Test Channels and Modes Detail.....	8
4. Configuration of EUT	8
5. Modification of EUT	8
6. Description of Support Device	9
7. Test Facility and Location	10
8. Applicable Standards and References	11
9. Deviations and Abnormalities from Standard Conditions	11
10. Test Conditions	12
11. Measurement Uncertainty	13
12. Sample Calculations	14
13. Test Items and Results	15
13.1 Conducted Emissions Measurement.....	15
13.2 Radiated Spurious Emissions and Restricted Bands Measurement	19
13.3 Channel Separation test.....	31
13.4 20dB Bandwidth	35
13.5 Hopping Channel Number	39
13.6 Time of Occupancy (Dwell Time).....	41
13.7 Maximum Peak Output Power	45
13.8 Band Edge Conducted Spurious Emission Measurement.....	49
13.9 Antenna Requirement	54
14. Test Equipment List.....	55

1. Summary of Test Result

FCC Rules	Description of Test	Result	Remarks
§15.247(a)(1)	Channel Separation test	PASS	---
§15.247(a)(1)	20dB Bandwidth	PASS	---
§15.247(a)(1)(iii)	Hopping Channel Number	PASS	---
§15.247(a)(1)(iii)	Time of Occupancy (Dwell Time)	PASS	---
§15.247(b)	Max Peak output Power test	PASS	---
§15.247(d)	Band edge test	PASS	---
§15.207 (a)	AC Power Conducted Emission	PASS	---
§15.247(d),§15.209, §15.205	Radiated Emission	PASS	---
§15.203	Antenna Requirement	PASS	---
§15.247(d)	Conducted Spurious Emission	PASS	---

2. General Description of EUT

Product Information	
Product Name:	Mobile Point of Sales terminal
Main Model Name:	M021
Additional Model Name:	M020
Model Difference:	Both M020 and M021 have the same design in circuit diagram and PCB layout, and the difference between M020 and M021 is that M021 supports colour touch screen and backlit keypad, but M020 only supports colour screen and non-backlit keypad.
S/N:	021-023862, 021-023850
Brand Name:	Miura Systems Ltd
Hardware Version:	M021-TEST04-V3-0
Software Version:	M000-TESTOS-V9-8k
Rating:	USB charging input: 5V 800mA DC; Internal Battery: 3.7Vdc 1150mAh
Typical arrangement:	Table-top
I/O Port:	Refer to user manual
Accessories Information	
Adapter:	N/A
Cable:	USB Line: 0.95m shielded, detachable
Other:	N/A
Additional Information	
Note:	According to these model differences, all tests were performed on model M021 according to the manufacturer requirement.
Remark:	All the information above are provided by the manufacturer. More detailed feature of the EUT please refers to the user manual.

Technical Specification	
Bluetooth Version:	V4.2
Frequency Range:	2402-2480MHz
Modulation Type:	GFSK, $\pi/4$ -DQPSK, 8DPSK
Number of Channel:	79 (refer to following channel list for details)
Channel Space:	1MHz
Antenna Type:	Chip Antenna
Antenna Gain:	3.50 dBi
Remark:	The manufacturer declared that the product does not support BLE feature.

Channel List							
Channel	Frequency (MHz)	Channel	Frequency (MHz)	Channel	Frequency (MHz)	Channel	Frequency (MHz)
0	2402	20	2422	40	2442	60	2462
1	2403	21	2423	41	2443	61	2463
2	2404	22	2424	42	2444	62	2464
3	2405	23	2425	43	2445	63	2465
4	2406	24	2426	44	2446	64	2466
5	2407	25	2427	45	2447	65	2467
6	2408	26	2428	46	2448	66	2468
7	2409	27	2429	47	2449	67	2469
8	2410	28	2430	48	2450	68	2470
9	2411	29	2431	49	2451	69	2471
10	2412	30	2432	50	2452	70	2472
11	2413	31	2433	51	2453	71	2473
12	2414	32	2434	52	2454	72	2474
13	2415	33	2435	53	2455	73	2475
14	2416	34	2436	54	2456	74	2476
15	2417	35	2437	55	2457	75	2477
16	2418	36	2438	56	2458	76	2478
17	2419	37	2439	57	2459	77	2479
18	2420	38	2440	58	2460	78	2480
19	2421	39	2441	59	2461	---	---

3. Test Channels and Modes Detail

No.	Mode	Channel	Frequency (MHz)	Modulation
1	TX	Hopping	2402-2480	GFSK / $\pi/4$ -DQPSK / 8DPSK
2	TX	Low	2402	GFSK / $\pi/4$ -DQPSK / 8DPSK
3	TX	Mid	2441	GFSK / $\pi/4$ -DQPSK / 8DPSK
4	TX	High	2480	GFSK / $\pi/4$ -DQPSK / 8DPSK
5	TX (Worst case) + NFC	---	---	---

Remark: The worst case of TX is “TX Low with 8DPSK modulation” according to the measured results.

Note: TX mode means that the EUT was programmed to be in continuously transmitting mode.

4. Configuration of EUT

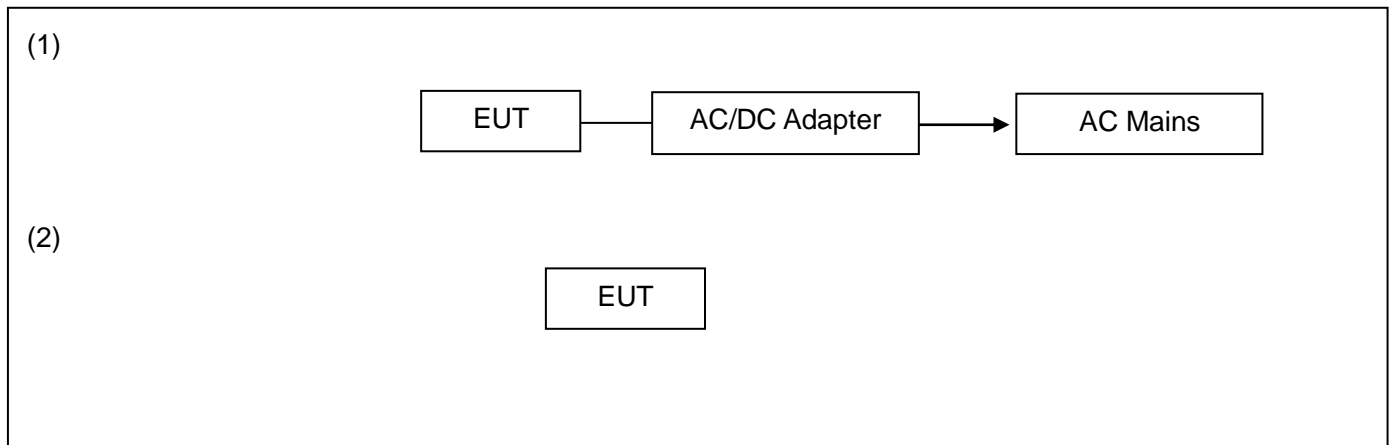

5. Modification of EUT

No modifications are made to the EUT during all test items.

6. Description of Support Device

The EUT has been tested as an independent unit together with other necessary accessories or support units. The following support units or accessories were used to form a representative test configuration during the tests.

No.	Equipment	Brand	M/N	S/N	Cable Specification	Remarks
1.	Adapter	HUAWEI	HW-050200C01	--	--	Provided by manufacturer

Software	Mode	Power Setting
Default	Default	Default

7. Test Facility and Location

Test Site	:	Dongguan Nore Testing Center Co., Ltd. (Dongguan NTC Co., Ltd.)
Accreditations and Authorizations	:	<p>The Laboratory has been assessed and proved to be in compliance with CNAS/CL01 Listed by CNAS, August 13, 2018 The Certificate Registration Number is L5795. The Certificate is valid until August 13, 2024</p> <p>The Laboratory has been assessed and proved to be in compliance with ISO17025 Listed by A2LA, November 01, 2017 The Certificate Registration Number is 4429.01 The Certificate is valid until December 31, 2023</p> <p>Listed by FCC, November 06, 2017 Test Firm Registration Number: 907417</p> <p>Listed by Industry Canada, June 08, 2017 The Certificate Registration Number. Is 46405-9743A The CAB identifier number: CN0015</p>
Test Site Location	:	Building D, Gaosheng Science and Technology Park, Hongtu Road, Nancheng District, Dongguan City, Guangdong Province, China

8. Applicable Standards and References

According to the specifications of the manufacturer, the EUT must comply with the requirements of the following standards:

Test Standards:

47 CFR Part 15, Subpart C, 15.247

ANSI C63.10-2013

References Test Guidance:

DTS KDB 558074 D01 15.247 Meas Guidance v05r02

Remark:

The EUT has also been tested and complied with the requirements of FCC Part 15, Subpart B, recorded in a separate test report.

9. Deviations and Abnormalities from Standard Conditions

No additions, deviations and exclusions from the standard.

10. Test Conditions

No.	Test Item	Test Mode	Test Voltage	Tested by	Remarks
1.	Channel Separation test	1	DC 3.7V	Sean Yuan	See note ¹
2.	20dB Bandwidth	2-4	DC 3.7V	Sean Yuan	See note ¹
3.	Hopping Channel Number	1	DC 3.7V	Sean Yuan	See note ¹
4.	Time of Occupancy (Dwell Time)	1	DC 3.7V	Sean Yuan	See note ¹
5.	Max Peak output Power test	2-4	DC 3.7V	Sean Yuan	See note ¹
6.	Band edge test	1-4	DC 3.7V	Sean Yuan	See note ¹
7.	AC Power Conducted Emission	1-5	AC 120V 60Hz	Sean Yuan	See note ¹
8.	Radiated Emission	1-5	AC 120V 60Hz DC 3.7V	Sean Yuan	See note ¹
9.	Antenna Requirement	---	---	---	---
10.	Conducted Spurious Emission	1-4	DC 3.7V	Sean Yuan	See note ¹

Note:

- The testing climatic conditions for temperature, humidity, and atmospheric pressure are within: 15~35 °C, 30~70%, 86~106kPa
- For test voltage AC 120V 60Hz was come from Adapter; DC 3.7V was come from internal li-ion battery.
- As the EUT can be operated multiple positions, all X,Y,Z axis were considered during the test and only the worst case Z was recorded.
- For AC Power Conducted Emission and Radiated Emission tests, all test modes are considered and tested, only the worst case was recorded in the report.
- Sample 021-023850 used for conducted measurement and 021-023862 used for Radiated Emission and AC Power Conducted Emission test.

11. Measurement Uncertainty

No.	Test Item	Frequency	Uncertainty	Remarks
1.	Conducted Emission	150KHz ~ 30MHz	±2.52 dB	---
2.	Radiated Emission	9kHz ~ 30MHz	±5.04 dB	
		30MHz ~ 1GHz	±5.04 dB	---
		1GHz ~ 18GHz	±5.23 dB	---
		18GHz ~ 40GHz	±5.23 dB	
3.	Conducted Spurious Emissions	10Hz ~ 40GHz	±0.78 dB	---
4.	RF Output Power	10Hz ~ 40GHz	±0.86 dB	
5.	Power Spectral Density	10Hz ~ 40GHz	±1.06 dB	
6.	Occupied Channel Bandwidth	---	±1.42 x10 ⁻⁷	---

Note:

1. This uncertainty represents an expanded uncertainty expressed at approximately the 95% confidence level using a coverage factor of k=2.
2. The measurement uncertainty levels above are estimated and calculated according to CISPR 16-4-2.
3. The conformity assessment statement in this report is based solely on the test results, measurement uncertainty is excluded.

12. Sample Calculations

Conducted Emission						
Freq. (MHz)	Reading Level (dBuV)	Correct Factor (dB)	Measurement (dBuV)	Limit (dBuV)	Over (dB)	Detector
0.1980	33.04	10.56	43.60	63.69	-20.09	QP

Where,

Freq. = Emission frequency in MHz

Reading Level = Spectrum Analyzer/Receiver Reading

Corrector Factor = Insertion loss of LISN + Cable Loss + RF Switching Unit attenuation

Measurement = Reading + Corrector Factor

Limit = Limit stated in standard

Margin = Measurement - Limit

Detector = Reading for Quasi-Peak / Average / Peak

Radiated Spurious Emissions and Restricted Bands						
Freq. (MHz)	Reading Level (dBuV)	Correct Factor (dB/m)	Measurement (dBuV/m)	Limit (dBuV/m)	Over (dB)	Detector
30.0000	29.39	-10.69	18.70	40.00	-21.30	QP

Where,

Freq. = Emission frequency in MHz

Reading Level = Spectrum Analyzer/Receiver Reading

Corrector Factor = Antenna Factor + Cable Loss - Pre-amplifier

Measurement = Reading + Corrector Factor

Limit = Limit stated in standard

Over = Margin, which calculated by Measurement - Limit

Detector = Reading for Quasi-Peak / Average / Peak

Note: For all conducted test items, the spectrum analyzer offset or transducer is derived from RF cable loss and attenuator factor. The offset or transducer is equal to the RF cable loss plus attenuator factor.

13. Test Items and Results

13.1 Conducted Emissions Measurement

LIMITS

According to the requirements of FCC PART 15.207, the limits are as follows:

Frequency (MHz)	Quasi-peak	Average
0.15 to 0.5	66 to 56	56 to 46
0.5 to 5	56	46
5 to 30	60	50

- Note:
1. If the limits for the average detector are met when using the quasi-peak detector, then the limits for the measurements with the average detector are considered to be met.
 2. The lower limit shall apply at the transition frequencies.
 3. The limit decreases linearly with the logarithm of the frequency in the range 0.15 MHz to 0.5MHz.

BLOCK DIAGRAM OF TEST SETUP

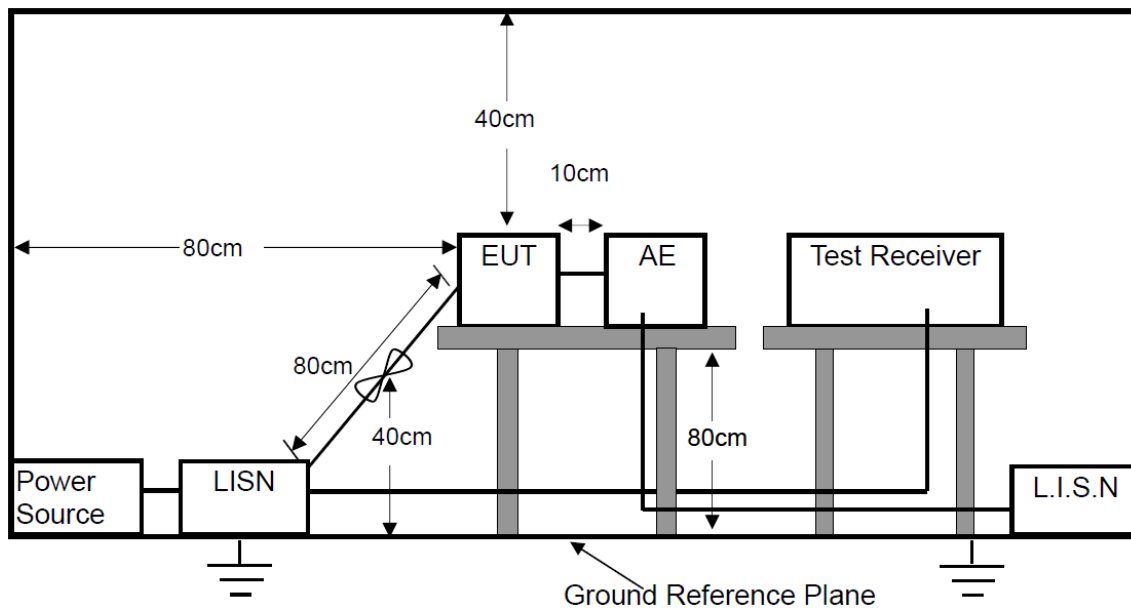

TEST PROCEDURES

- a. The EUT was placed on a wooden table 0.8m height from the metal ground plan and 0.4m from the conducting wall of the shielding room and it was kept at 0.8m from any other grounded conducting surface.
- b. All I/O cables and support devices were positioned as per ANSI C63.10.
- c. Connect mains power port of the EUT to a line impedance stabilization network (LISN).
- d. Connect all support devices to the other LISN and AAN, if needed.
- e. Scan the frequency range from 150KHz to 30MHz at both sides of AC line for maximum conducted interference checking and record the test data.

TEST RESULTS

PASS

Please refer to the following pages of the worst case.

M/N: M021	Testing Voltage: AC 120V 60Hz
Phase: L1	Detector: QP & AVG
Test Mode: 5	

Conducted Emission Measurement

Date: 2023/5/5

Time: 17:53:26

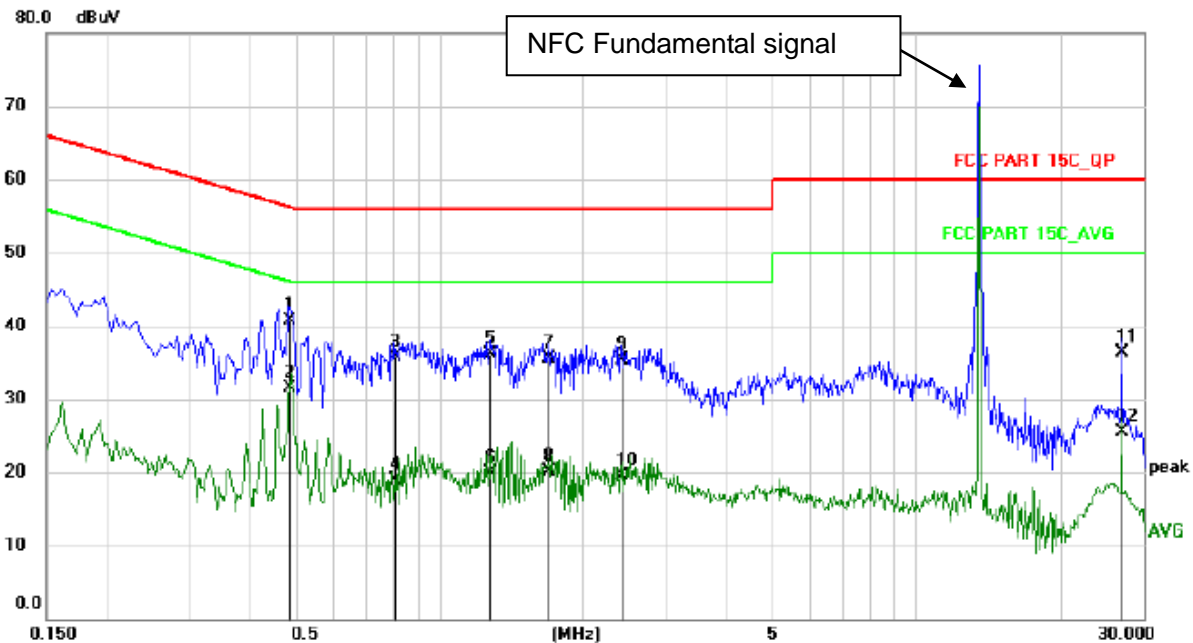

No. Mk.	Freq.	Reading Level	Correct Factor	Measurement	Limit	Over	Detector	Comment
	MHz	dBuV	dB	dBuV	dBuV	dB		
1	0.4860	30.18	10.61	40.79	56.24	-15.45	QP	
2 *	0.4860	20.81	10.61	31.42	46.24	-14.82	AVG	
3	0.8059	25.18	10.61	35.79	56.00	-20.21	QP	
4	0.8059	8.24	10.61	18.85	46.00	-27.15	AVG	
5	1.2820	25.42	10.61	36.03	56.00	-19.97	QP	
6	1.2820	9.25	10.61	19.86	46.00	-26.14	AVG	
7	1.6900	24.88	10.61	35.49	56.00	-20.51	QP	
8	1.6900	9.55	10.61	20.16	46.00	-25.84	AVG	
9	2.4060	24.73	10.62	35.35	56.00	-20.65	QP	
10	2.4060	8.93	10.62	19.55	46.00	-26.45	AVG	
11	27.1220	25.24	11.14	36.38	60.00	-23.62	QP	
12	27.1220	14.45	11.14	25.59	50.00	-24.41	AVG	

M/N: M021	Testing Voltage: AC 120V 60Hz
Phase: N	Detector: QP & AVG
Test Mode: 5	

Conducted Emission Measurement

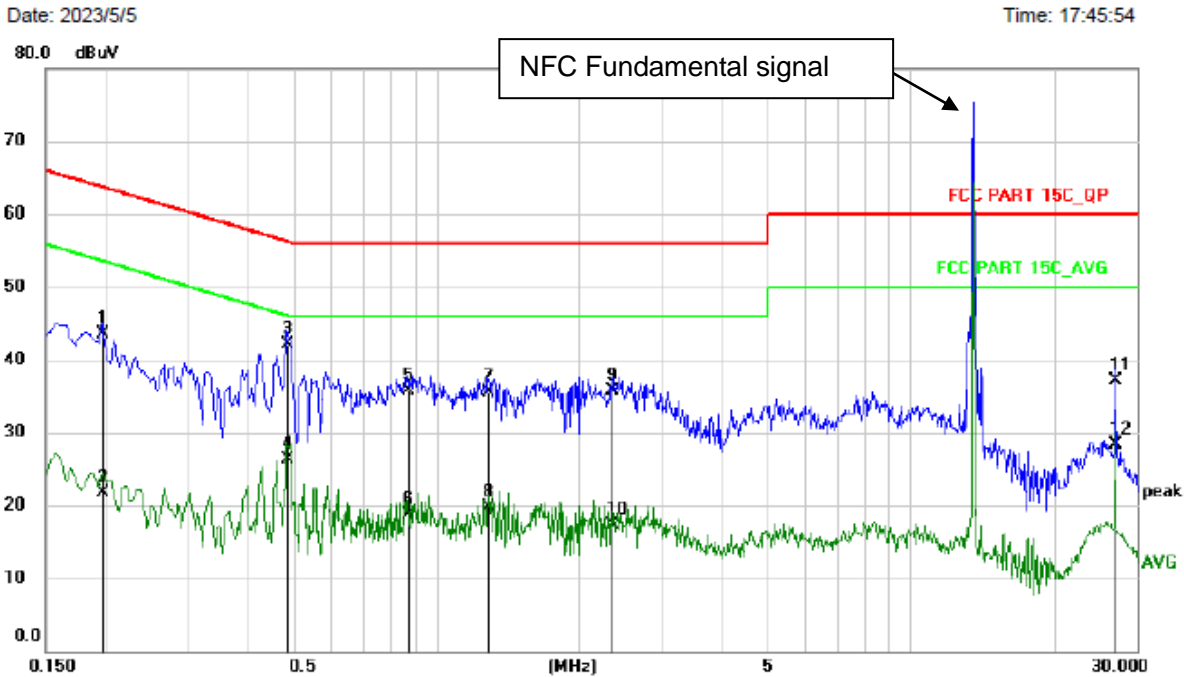

No. Mk.	Freq.	Reading Level	Correct Factor	Measurement	Limit	Over	Detector	Comment
	MHz	dBuV	dB	dBuV	dBuV	dB		
1	0.1980	33.04	10.56	43.60	63.69	-20.09	QP	
2	0.1980	11.16	10.56	21.72	53.69	-31.97	AVG	
3 *	0.4858	31.61	10.57	42.18	56.24	-14.06	QP	
4	0.4858	15.65	10.57	26.22	46.24	-20.02	AVG	
5	0.8700	25.21	10.57	35.78	56.00	-20.22	QP	
6	0.8700	8.05	10.57	18.62	46.00	-27.38	AVG	
7	1.2860	24.85	10.57	35.42	56.00	-20.58	QP	
8	1.2860	9.08	10.57	19.65	46.00	-26.35	AVG	
9	2.3340	25.05	10.57	35.62	56.00	-20.38	QP	
10	2.3340	6.79	10.57	17.36	46.00	-28.64	AVG	
11	27.1219	26.02	11.13	37.15	60.00	-22.85	QP	
12	27.1219	17.27	11.13	28.40	50.00	-21.60	AVG	

13.2 Radiated Spurious Emissions and Restricted Bands Measurement

LIMIT of Radiated Band Edges and non-restricted bands

In any 100 kHz bandwidth outside the intentional radiator frequency band, all harmonics/spurious must be at least 20 dB below the highest emission level within the authorized band. If the output power of this device was measured by spectrum analyzer, the attenuation under this paragraph shall be 30 dB instead of 20 dB.

LIMIT of Restricted bands

In addition, radiated emissions which fall in the restricted bands must also comply with the limits as below:

Frequency range MHz	Distance Meters	Field Strengths Limit (15.209)
		μV/m
0.009 ~ 0.490	300	2400/F(kHz)
0.490 ~ 1.705	30	24000/F(kHz)
1.705 ~ 30	30	30
30 ~ 88	3	100
88 ~ 216	3	150
216 ~ 960	3	200
Above 960	3	500

Remark: (1) Emission level (dB)μV = 20 log Emission level μV/m
 (2) The smaller limit shall apply at the cross point between two frequency bands.
 (3) As shown in 15.35(b), for frequencies above 1000MHz, the field strength limits are based on average detector, however, the peak field strength of any emission shall not exceed the maximum permitted average limits, specified above by more than 20dB under any condition of modulation.
 (4) The frequency range scanned is from the lowest radio frequency signal generated in the device which is greater than 9 kHz to the tenth harmonic of the highest fundamental frequency or 40 GHz, whichever is lower.
 (5) §15.247(d) specifies that emissions which fall in the restricted bands, as defined in §15.205 comply with radiated emission limits specified in §15.209.

BLOCK DIAGRAM OF TEST SETUP

For Radiated Emission below 30MHz

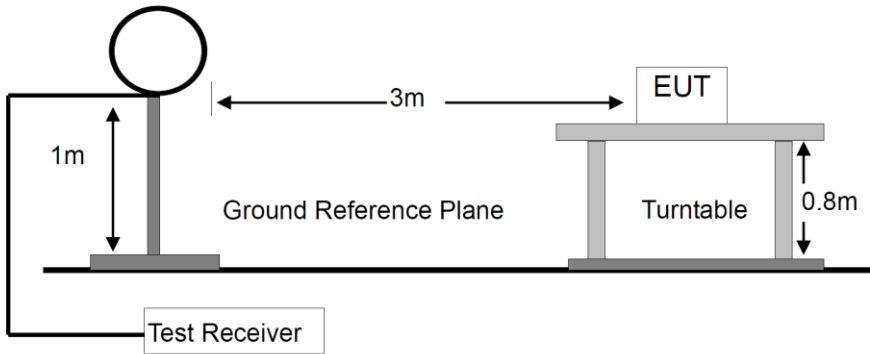

For Radiated Emission 30-1000MHz

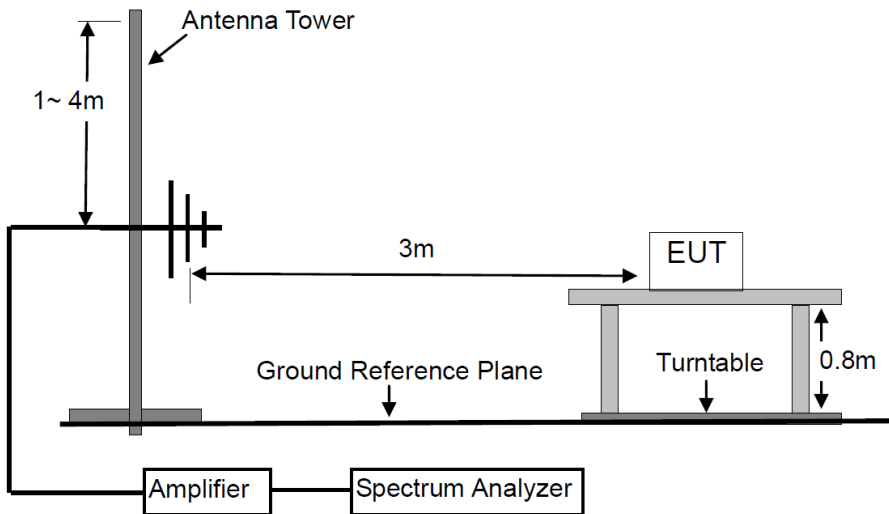

For Radiated Emission Above 1000MHz.

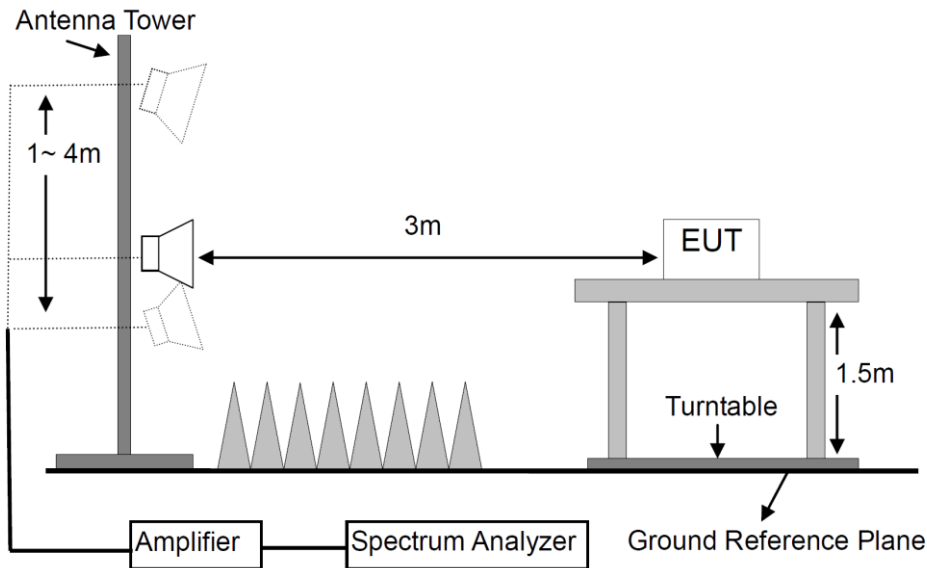

TEST PROCEDURES

- a. Below 1GHz, the EUT was placed on the top of a rotating table 0.8 meters above the ground at a 3 meter semi- anechoic chamber room.
- b. For the radiated emission test above 1GHz:

The EUT was placed on the top of a rotating table 1.5 meters above the ground at a 3 meter full anechoic chamber room. The table was rotated 360 degrees to determine the position of the highest radiation. Place the measurement antenna away from each area of the EUT determined to be a source of emissions at the specified measurement distance, while keeping the measurement antenna aimed at the source of emissions at each frequency of significant emissions, with polarization oriented for maximum response. The measurement antenna may have to be higher or lower than the EUT, depending on the radiation pattern of the emission and staying aimed at the emission source for receiving the maximum signal. The final measurement antenna elevation shall be that which maximizes the emissions. The measurement antenna elevation for maximum emissions shall be restricted to a range of heights of from 1 m to 4 m above the ground or reference ground plane.
- c. The EUT was set 3 meters away from the interference-receiving antenna, which was mounted on the top of a variable-height antenna tower.
- d. The height of antenna is varied from one meter to four meters above the ground to determine the maximum value of the field strength. Both horizontal and vertical polarizations of the antenna are set to make the measurement.

- e. For each suspected emission, the EUT was arranged to its worst case and then the antenna was tuned to heights from 1 meter to 4 meters and the rotatable table was turned from 0 degrees to 360 degrees to find the maximum reading. The test-receiver system was set to peak detect function and specified bandwidth with maximum hold mode.
- f. A Quasi-peak measurement was then made for that frequency point for below 1GHz test. PK and AV for above 1GHz emission test.
- g. Pre-Scan has been conducted to determine the worst-case mode from all possible combinations between available modulations, data rates, XYZ axis and packet type.

The worst case was found when the EUT was positioned on Z axis for radiated emission.

During the radiated emission test, the spectrum analyzer was set with the following configurations:

Frequency Band (MHz)	Detector	Resolution Bandwidth	Video Bandwidth
0.009~0.15	QP & AVG	200 Hz	1 kHz
0.15~30	QP & AVG	10 kHz	30 kHz
30 to 1000	QP	120 kHz	300 kHz
Above 1000	Peak	1 MHz	3 MHz
	Average	1 MHz	10 Hz

TEST RESULTS

PASS

Please refer to the following pages of the worst case.

M/N: M021	Testing Voltage: AC 120V 60Hz
Polarization: Horizontal	Detector: QP & AVG
Test Mode: 5	Distance: 3m

Radiated Emission Measurement

Date: 2023/5/15 Time: 15:07:04

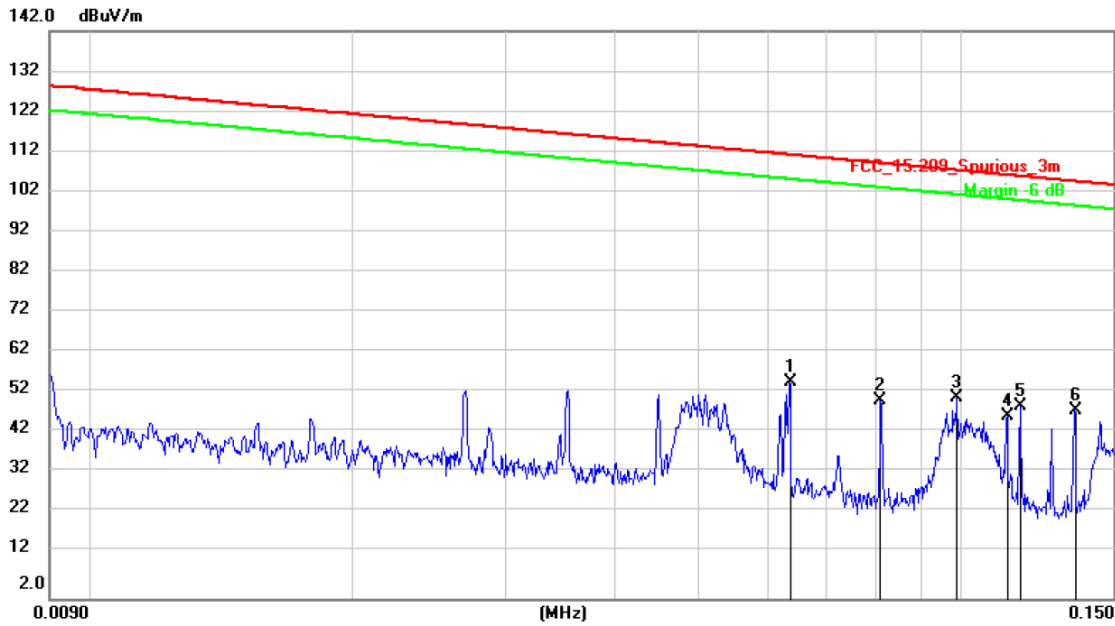

No.	Mk.	Freq.	Reading Level	Correct Factor	Measurement	Limit	Over	Detector	Comment
		MHz	dBuV	dB/m	dBuV/m	dBuV/m	dB		
1	*	0.0636	35.01	20.53	55.54	111.49	-55.95	AVG	
2		0.0810	30.32	20.53	50.85	109.39	-58.54	AVG	
3		0.0991	31.05	20.54	51.59	107.64	-56.05	QP	
4		0.1132	26.29	20.53	46.82	106.49	-59.67	AVG	
5		0.1171	28.92	20.53	49.45	106.20	-56.75	AVG	
6		0.1352	27.72	20.53	48.25	104.95	-56.70	AVG	

M/N: M021	Testing Voltage: AC 120V 60Hz
Polarization: Horizontal	Detector: QP & AVG
Test Mode: 5	Distance: 3m

Radiated Emission Measurement

Date: 2023/5/15

Time: 15:00:18

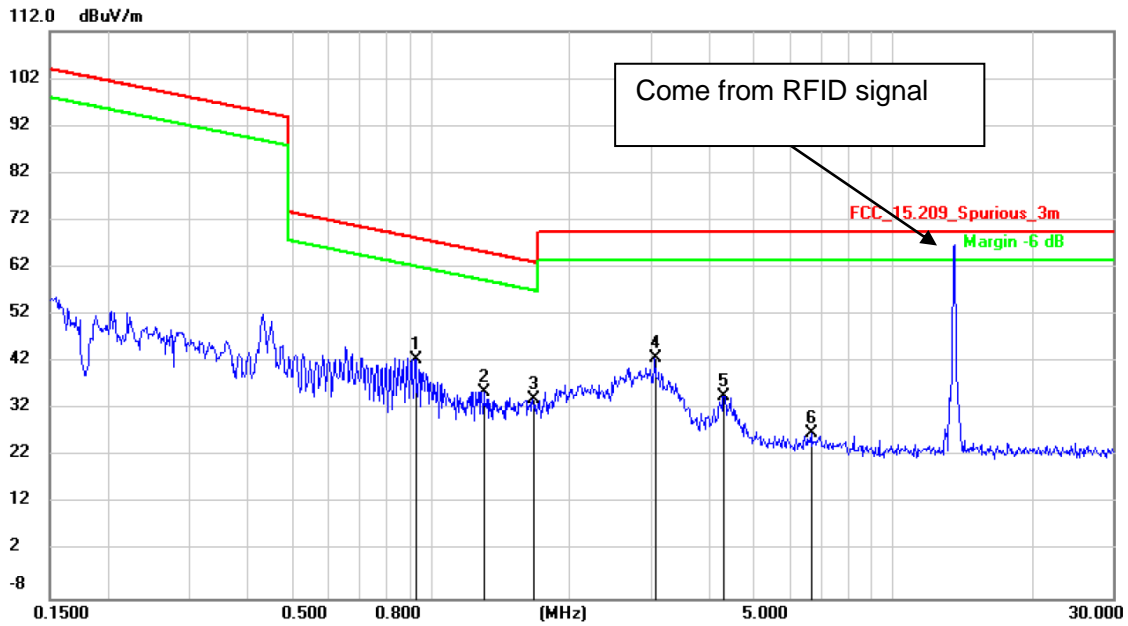

No.	Mk.	Freq.	Reading Level	Correct Factor	Measurement	Limit	Over	Detector	Comment
		MHz	dBuV	dB/m	dBuV/m	dBuV/m	dB		
1	*	0.9282	22.12	20.40	42.52	68.25	-25.73	QP	
2		1.3029	15.34	20.40	35.74	65.31	-29.57	QP	
3		1.6625	13.86	20.40	34.26	63.19	-28.93	QP	
4		3.0576	22.35	20.40	42.75	69.50	-26.75	QP	
5		4.3146	14.43	20.44	34.87	69.50	-34.63	QP	
6		6.6624	6.40	20.48	26.88	69.50	-42.62	QP	

M/N: M021	Testing Voltage: AC 120V 60Hz
Polarization: Vertical	Detector: QP & AVG
Test Mode: 5	Distance: 3m

Radiated Emission Measurement

Date: 2023/5/15

Time: 14:48:05

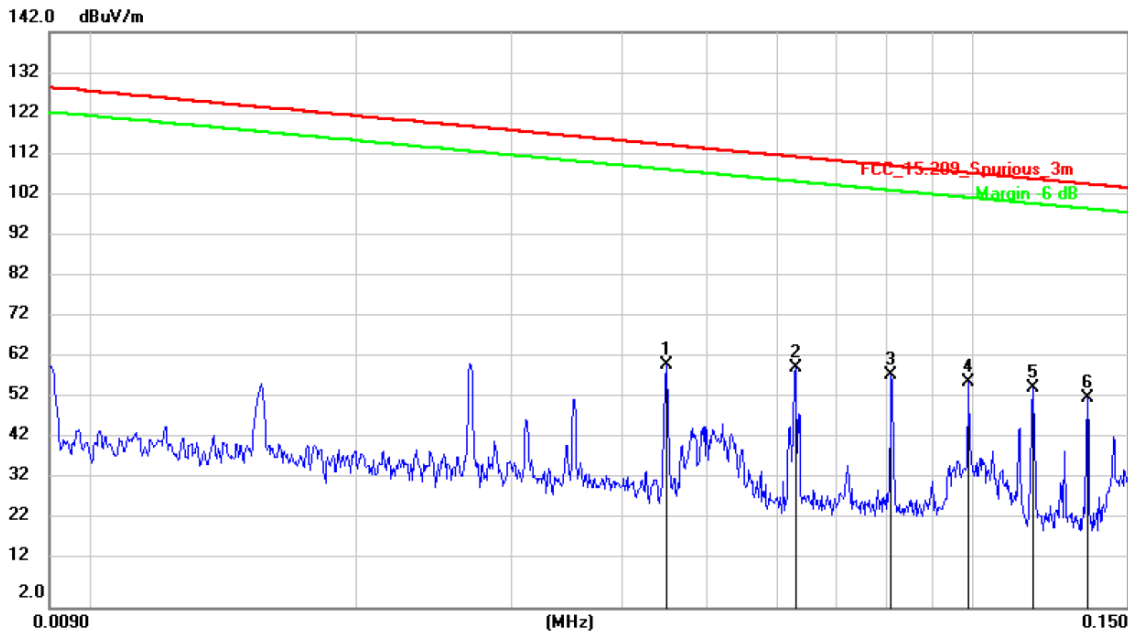

No.	Mk.	Freq.	Reading Level	Correct Factor	Measurement	Limit	Over	Detector	Comment
		MHz	dBuV	dB/m	dBuV/m	dBuV/m	dB		
1		0.0449	40.26	20.59	60.85	114.50	-53.65	AVG	
2		0.0629	39.65	20.53	60.18	111.58	-51.40	AVG	
3	*	0.0810	38.14	20.53	58.67	109.39	-50.72	AVG	
4		0.0991	36.14	20.54	56.68	107.64	-50.96	QP	
5		0.1171	34.87	20.53	55.40	106.20	-50.80	AVG	
6		0.1351	32.46	20.53	52.99	104.96	-51.97	AVG	

M/N: M021	Testing Voltage: AC 120V 60Hz
Polarization: Vertical	Detector: QP & AVG
Test Mode: 5	Distance: 3m

Radiated Emission Measurement

Date: 2023/5/15

Time: 14:54:23

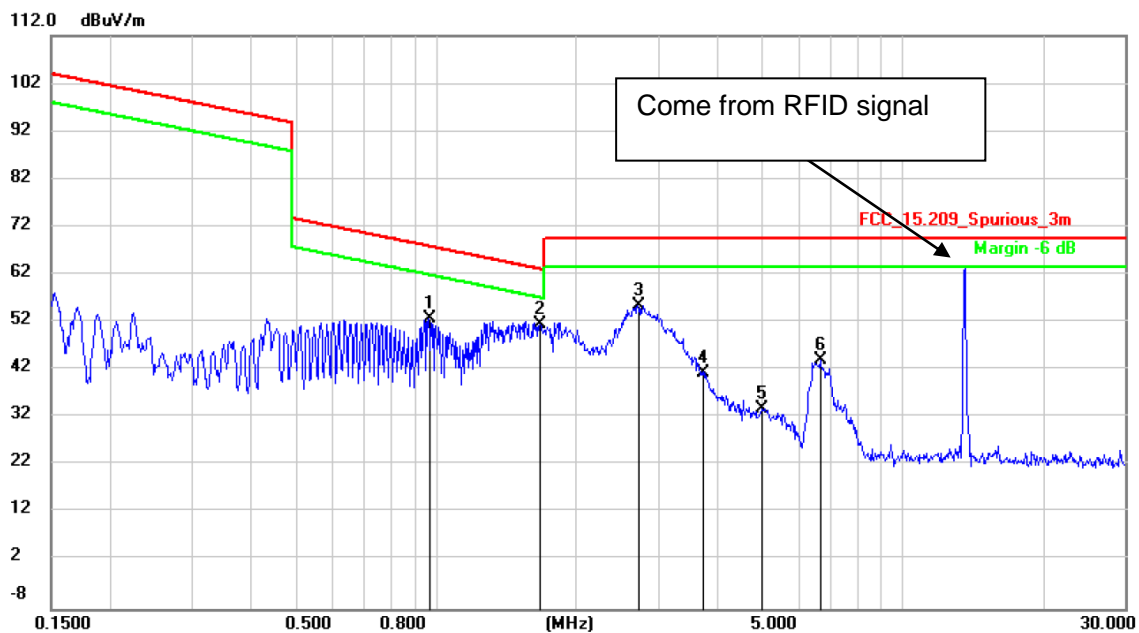

No.	Mk.	Freq.	Reading Level	Correct Factor	Measurement	Limit	Over	Detector	Comment
		MHz	dBuV	dB/m	dBuV/m	dBuV/m	dB		
1		0.9633	32.43	20.40	52.83	67.93	-15.10	QP	
2	*	1.6713	31.22	20.40	51.62	63.14	-11.52	QP	
3		2.7068	35.19	20.40	55.59	69.50	-13.91	QP	
4		3.7395	21.08	20.42	41.50	69.50	-28.00	QP	
5		5.0046	13.52	20.45	33.97	69.50	-35.53	QP	
6		6.6624	23.54	20.48	44.02	69.50	-25.48	QP	

M/N: M021	Testing Voltage: AC 120V 60Hz
Polarization: Horizontal	Detector: QP
Test Mode: 5	Distance: 3m

Radiated Emission Measurement

Date: 2023/5/17

Time: 0:14:15

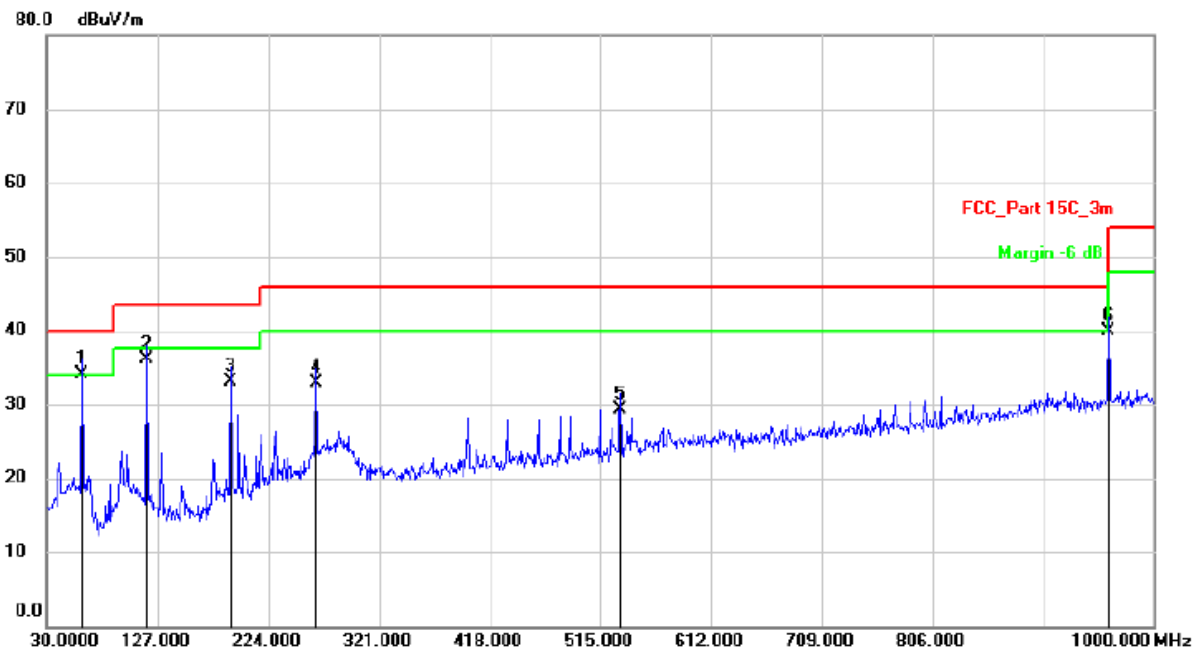

No.	Mk.	Freq. MHz	Reading Level dBuV	Correct Factor dB/m	Measure- ment dBuV/m	Limit dBuV/m	Over dB	Detector	Comment
1	*	60.0700	41.36	-7.26	34.10	40.00	-5.90	QP	
2		117.3000	44.93	-8.83	36.10	43.50	-7.40	QP	
3		191.0200	41.30	-8.20	33.10	43.50	-10.40	QP	
4		265.7100	38.98	-6.08	32.90	46.00	-13.10	QP	
5		532.4600	30.61	-1.21	29.40	46.00	-16.60	QP	
6		960.2300	33.60	6.30	39.90	54.00	-14.10	QP	

M/N: M021	Testing Voltage: AC 120V 60Hz
Polarization: Vertical	Detector: QP
Test Mode: 5	Distance: 3m

Radiated Emission Measurement

Date: 2023/5/17

Time: 0:20:30

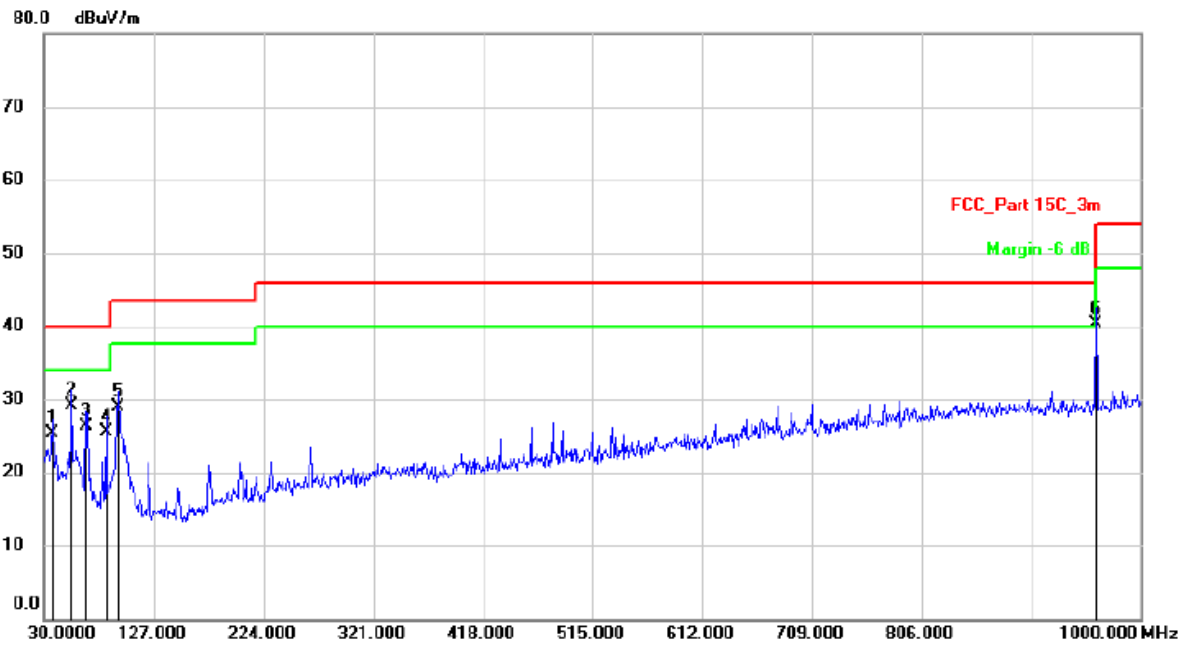

No.	Mk.	Freq.	Reading Level	Correct Factor	Measurement	Limit	Over	Detector	Comment
		MHz	dBuV	dB/m	dBuV/m	dBuV/m	dB		
1		36.7900	33.91	-8.61	25.30	40.00	-14.70	QP	
2	*	54.2500	36.84	-7.64	29.20	40.00	-10.80	QP	
3		66.8600	36.15	-9.85	26.30	40.00	-13.70	QP	
4		84.3200	36.57	-10.97	25.60	40.00	-14.40	QP	
5		94.9900	38.20	-9.20	29.00	43.50	-14.50	QP	
6		960.2300	35.27	5.13	40.40	54.00	-13.60	QP	

Modulation: 8DPSK (the worst case)					Test Result: PASS		Test frequency range: 1-25GHz			
Freq. (MHz)	Ant. Pol. (H/V)	Reading Level(dBuV)		Factor (dB/m)	Emission Level (dBuV/m)		Limit 3m (dBuV/m)		Margin (dB)	
		PK	AV		PK	AV	PK	AV	PK	AV
Operation Mode: TX Mode (Low) + NFC										
4804	H	46.06	34.14	6.30	52.36	40.44	74.00	54.00	-21.64	-13.56
7206	H	46.66	33.77	10.44	57.10	44.21	74.00	54.00	-16.90	-9.79

4804	V	46.63	33.99	6.30	52.93	40.29	74.00	54.00	-21.07	-13.71
7206	V	46.06	33.66	10.44	56.50	44.10	74.00	54.00	-17.50	-9.90

Operation Mode: TX Mode (Mid) + NFC										
4882	H	45.30	33.28	6.60	51.90	39.88	74.00	54.00	-22.10	-14.12
7323	H	46.25	33.85	10.55	56.80	44.40	74.00	54.00	-17.20	-9.60

4882	V	45.70	33.35	6.60	52.30	39.95	74.00	54.00	-21.70	-14.05
7323	V	45.53	33.85	10.55	56.08	44.40	74.00	54.00	-17.92	-9.60

Operation Mode: TX Mode (High) + NFC										
4960	H	44.57	33.10	6.89	51.46	39.99	74.00	54.00	-22.54	-14.01
7440	H	45.63	32.78	10.60	56.23	43.38	74.00	54.00	-17.77	-10.62

4960	V	44.63	33.33	6.89	51.52	40.22	74.00	54.00	-22.48	-13.78
7440	V	44.79	33.15	10.60	55.39	43.75	74.00	54.00	-18.61	-10.25

Spurious Emission in restricted band:										
2390.000	H	46.29	34.23	0.09	46.38	34.32	74.00	54.00	-27.62	-19.68
2390.000	V	46.46	34.38	0.09	46.55	34.47	74.00	54.00	-27.45	-19.53
2483.500	H	46.13	35.28	0.34	46.47	35.62	74.00	54.00	-27.53	-18.38
2483.500	V	45.79	34.58	0.34	46.13	34.92	74.00	54.00	-27.87	-19.08

Remark: Data of measurement within this frequency range shown “---” in the table above means the reading of emissions are attenuated more than 20dB below the permissible limits.

Operation Mode: TX Mode (Low) + NFC

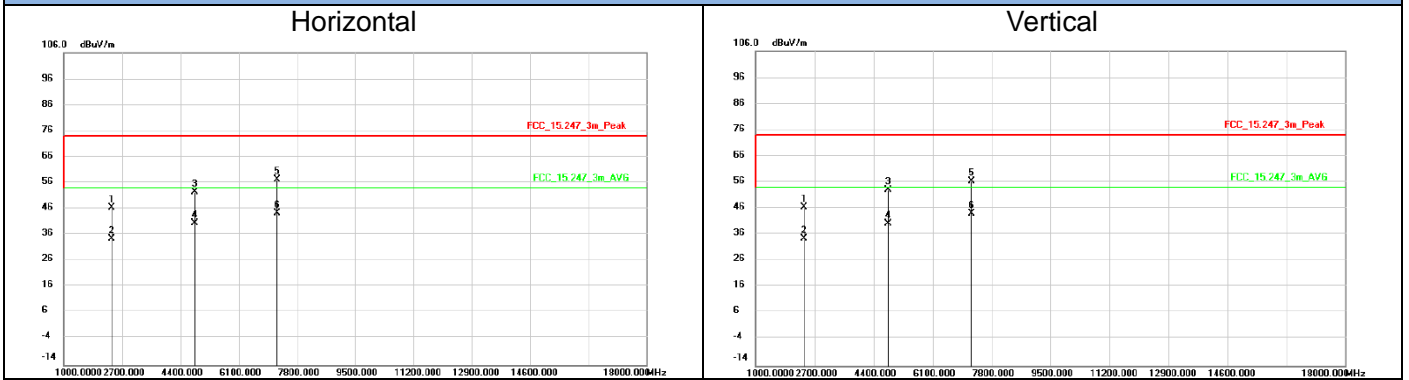

Operation Mode: TX Mode (Mid) + NFC

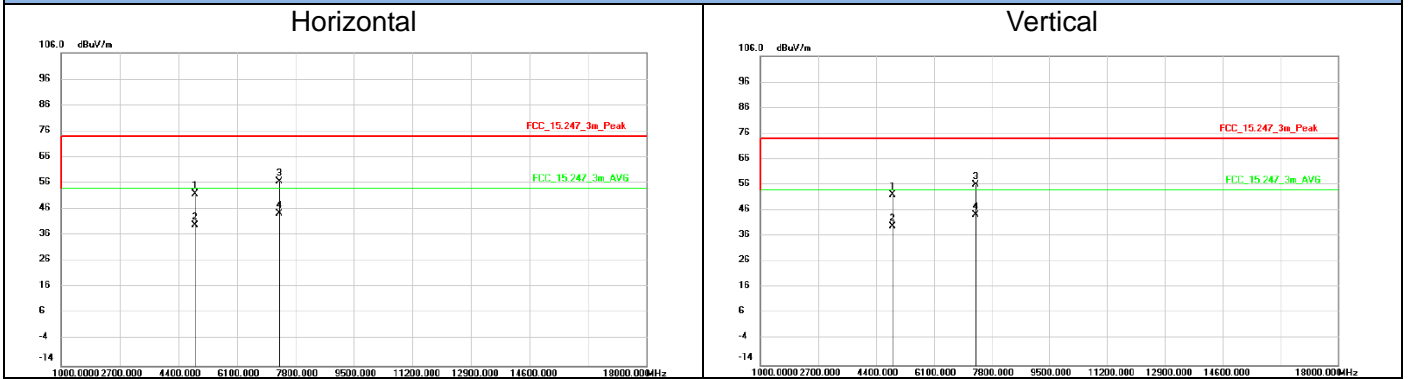

Operation Mode: TX Mode (High) + NFC

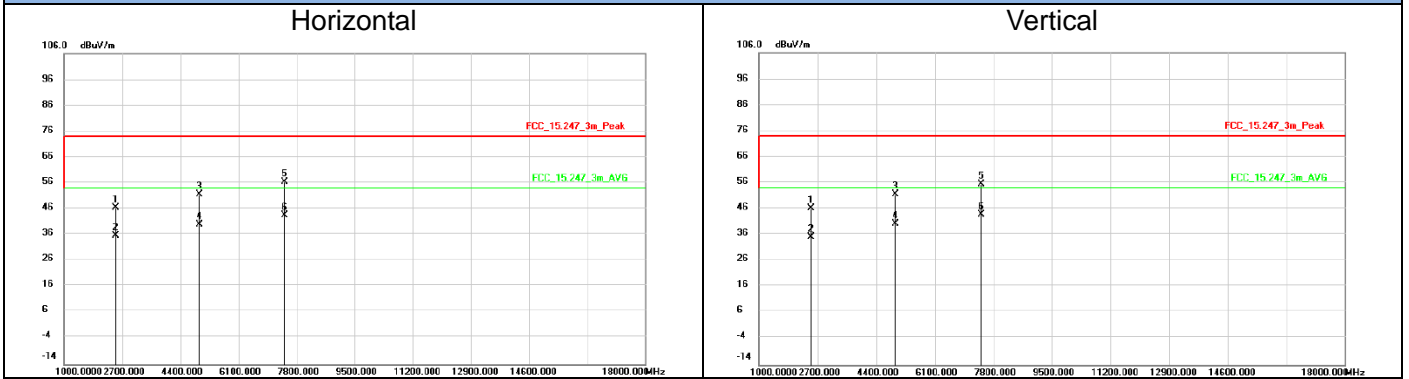

13.3 Channel Separation test

LIMIT

Frequency hopping systems operating in the 2400-2483.5 MHz band may have hopping channel carrier frequencies that are separated by 25 kHz or two-thirds of the 20 dB bandwidth of the hopping channel, whichever is greater.

BLOCK DIAGRAM OF TEST SETUP

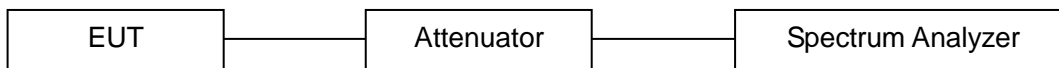

TEST PROCEDURES

- a. The RF output of EUT was connected to the spectrum analyzer by RF cable and attenuator. The path loss was compensated to the results for each measurement.
- b. Set to the maximum power setting and enable the EUT transmit continuously.
- c. Enable the EUT hopping function.
- d. Set spectrum analyzer and perform testing according to ANSI C63.10 clause 7.8.2.

TEST RESULTS

PASS

Please refer to the following tables.

Modulation	Channel	Frequency (MHz)	Hopping Separation Measurement (MHz)	Hopping Separation Limit (KHz)	Test Result
GFSK	Low	2402	0.996	>647.7	Pass
	Mid	2441	0.996	>626.9	Pass
	High	2480	0.999	>651.9	Pass
$\pi/4$ -DQPSK	Low	2402	0.999	>836.0	Pass
	Mid	2441	1.011	>823.3	Pass
	High	2480	0.999	>819.3	Pass
8DPSK	Low	2402	1.005	>846.0	Pass
	Mid	2441	0.999	>852.0	Pass
	High	2480	0.999	>844.7	Pass

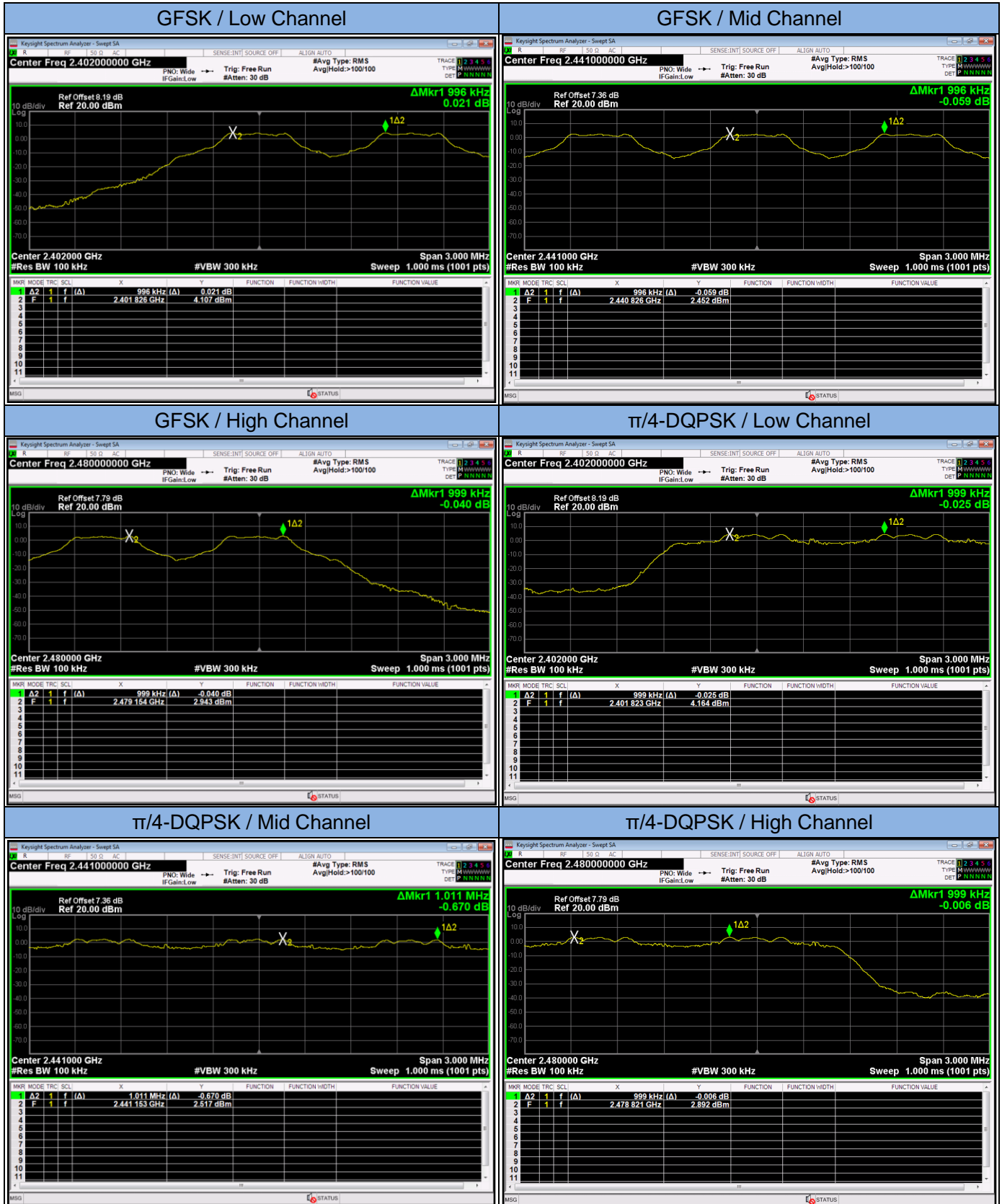



13.4 20dB Bandwidth

LIMIT

N/A

BLOCK DIAGRAM OF TEST SETUP

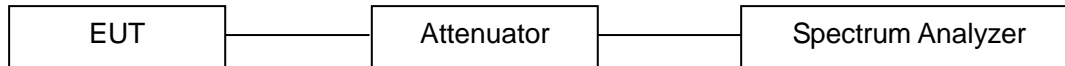

TEST PROCEDURES

- a. The RF output of EUT was connected to the spectrum analyzer by RF cable and attenuator. The path loss was compensated to the results for each measurement.
- b. Set to the maximum power setting and enable the EUT transmit continuously.
- c. Set spectrum analyzer and perform testing according to ANSI C63.10 clause 6.9.2.

TEST RESULTS

PASS

Please refer to the following tables.