



SMD CERAMIC ANTENNA

Data Sheet

HZ3215WA01

CA-2450-31-SE

For 2400-2484MHz
3.2x1.6mm [EIA1206]

FEATURES

- Light weight,compact
- Wide bandwidth,lowcost
- Built-in antenna with high gain

APPLICATIONS

- Bluetooth
- IEEE802.11g/b
- Zigbee systems,etc...

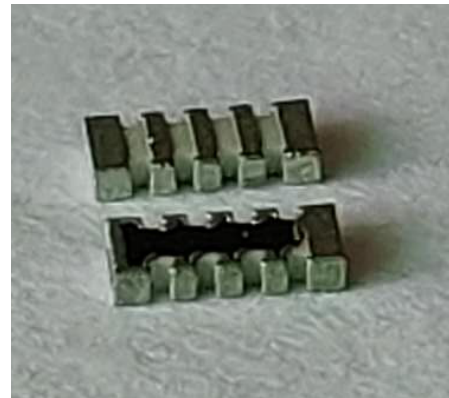

SHAPES AND DIMENSIONS Dimensions in mm

[Top view]

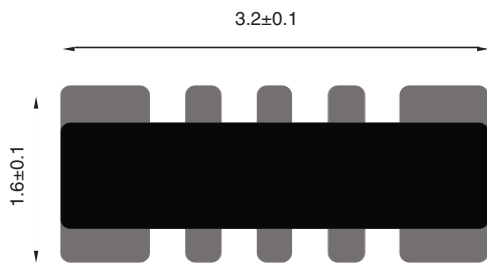

[Bottom view]

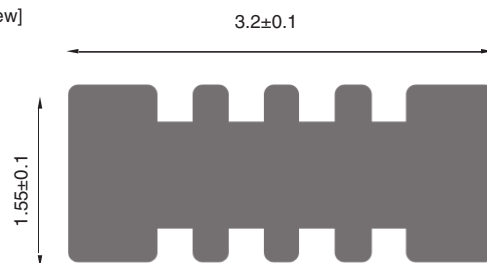

[Side view]

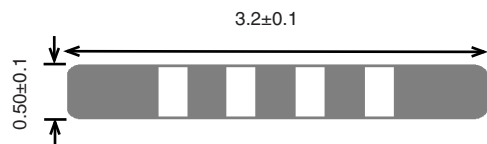

RECOMMENDED LAND PATTERN



Dimensions in mm

OLDER RESIST PATTERN

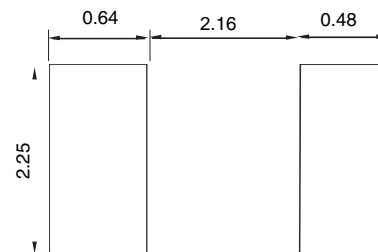

Dimensions in mm

■ ELECTRIC SPECIFICATIONS

Product type	CA-2450-31-SE
Center Frequency Range	2450MHZ
Peak Gain	1.7dBi
Input Impedance	50 Ω

■ PART NUMBERING SYSTEM

CA - 2450 - 31 - SE
Material Frequency Size Series

■ EVALUATION BOARD

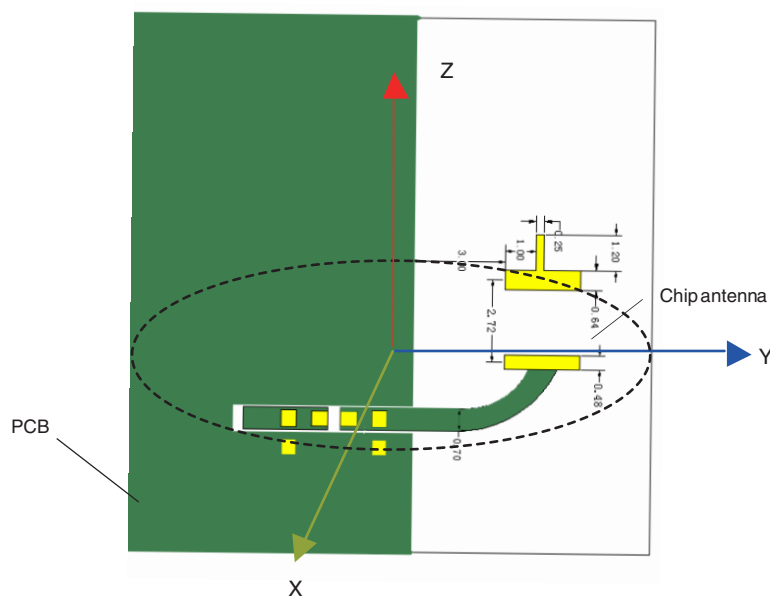
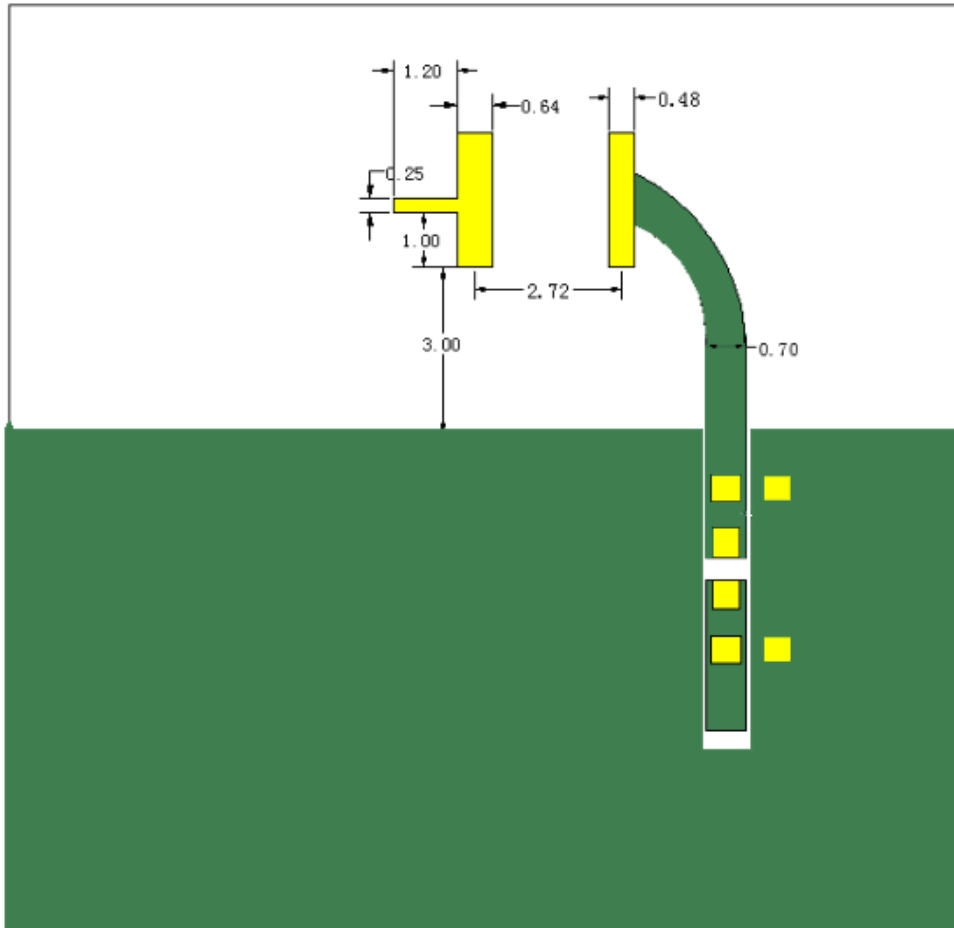

■ RADIATION PATTERNS

□ 2.4GHz WLAN BAND

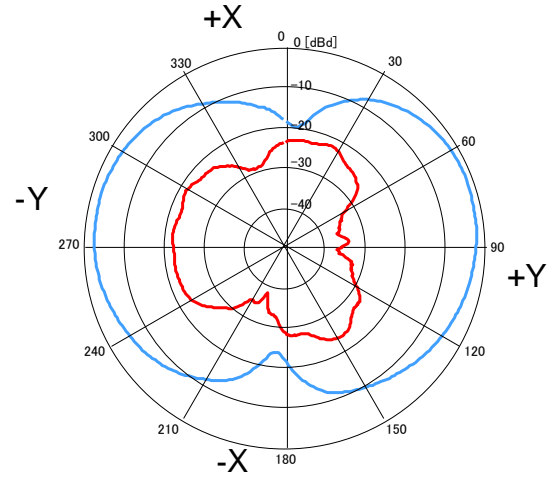
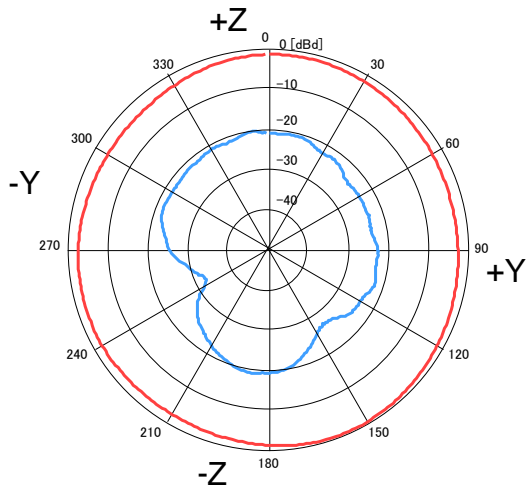

FREQUENCY CHARACTERISTICS

EFFICIENCY AND VSWR

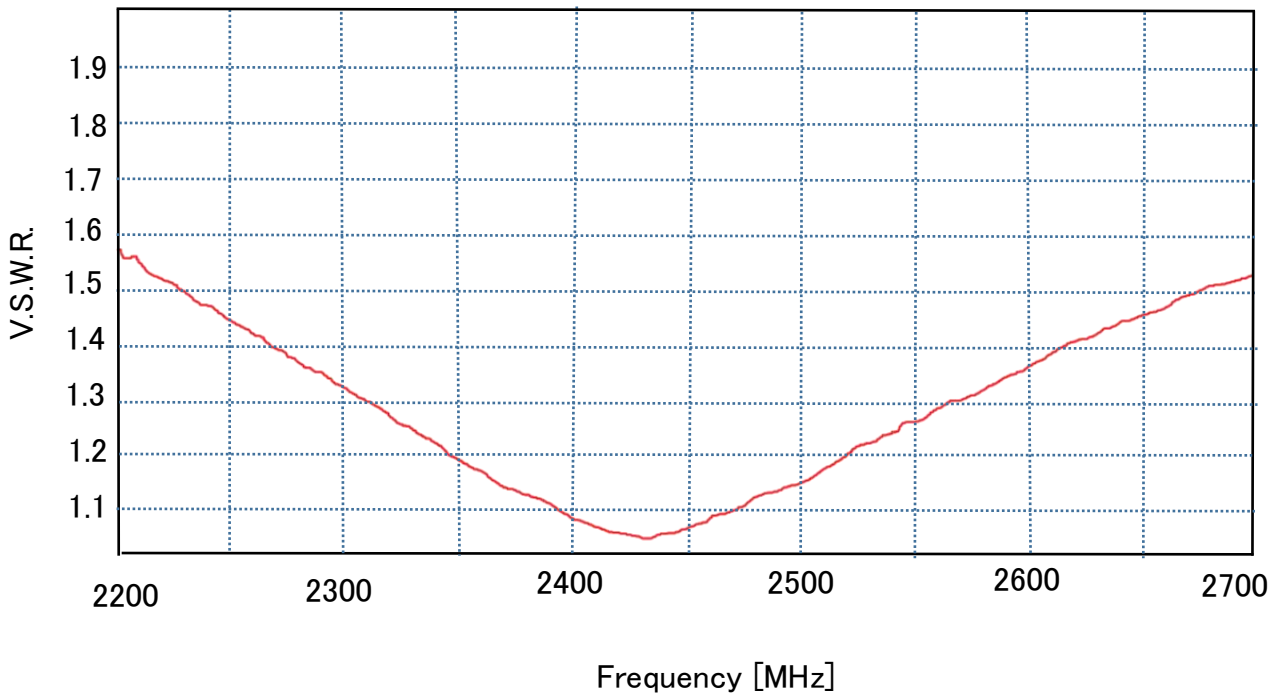

■ RECOMMENDED REFLOW PROFILE

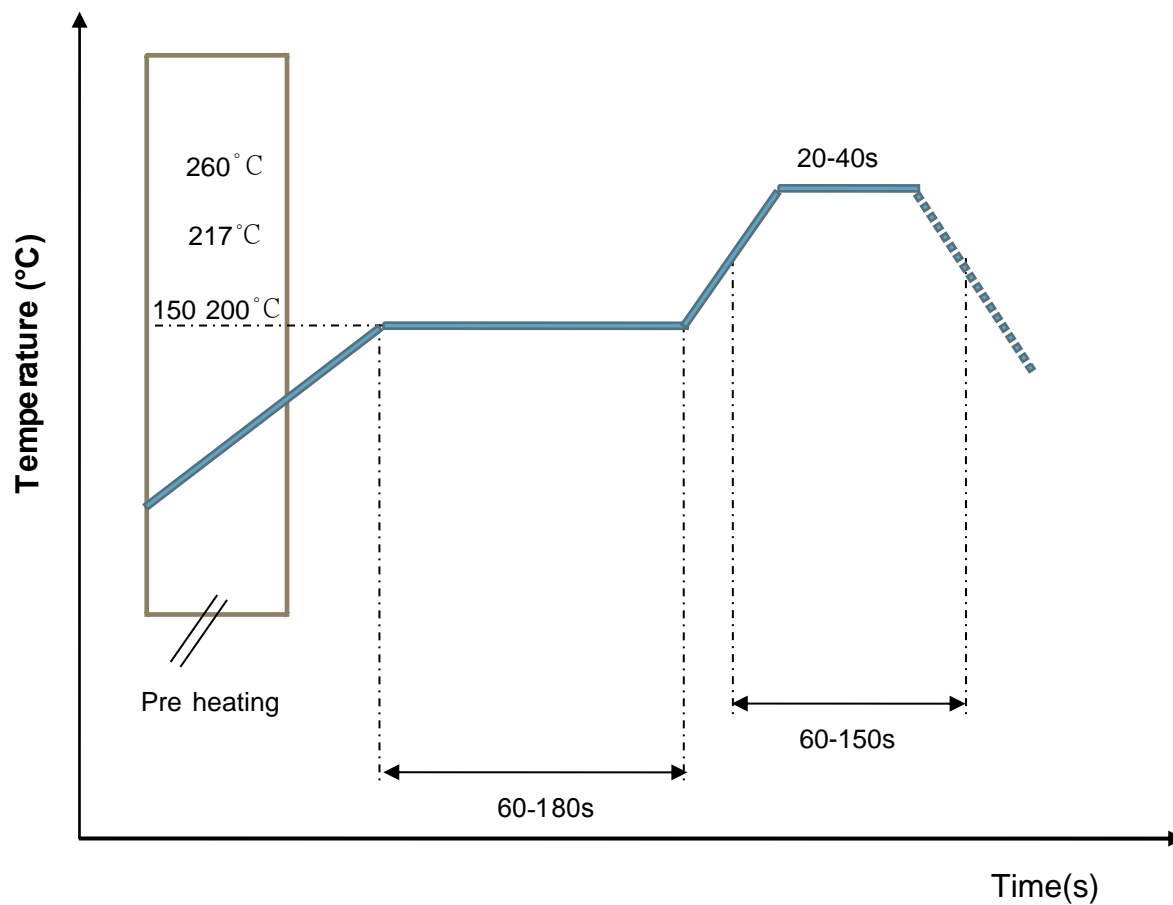

PACKAGING STYLE

REEL DIMENSIONS

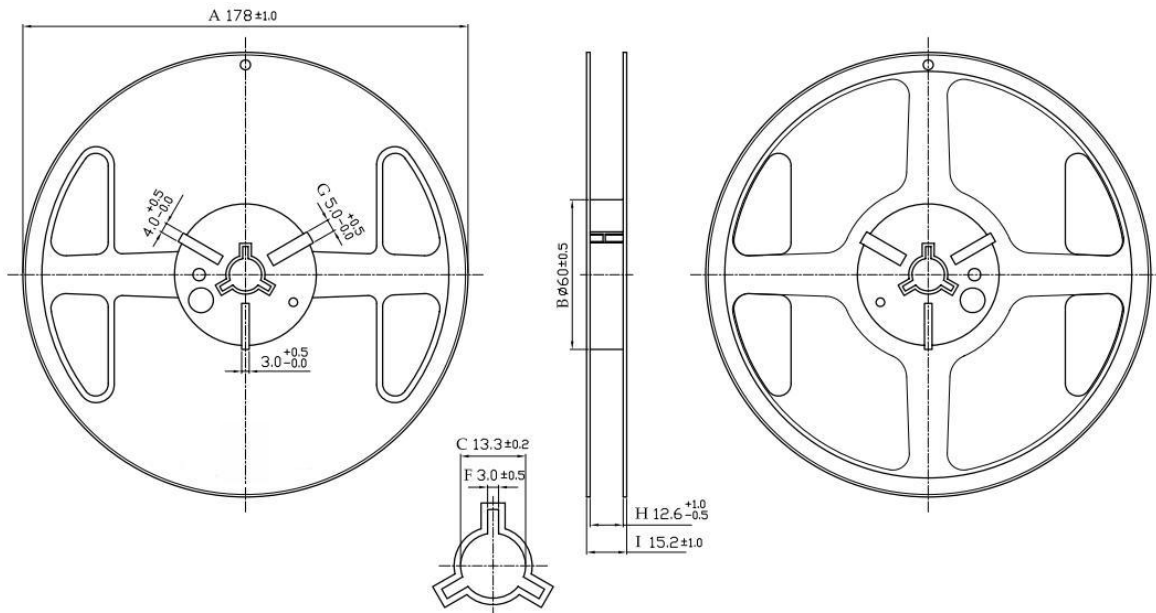

TAPE DIMENSIONS

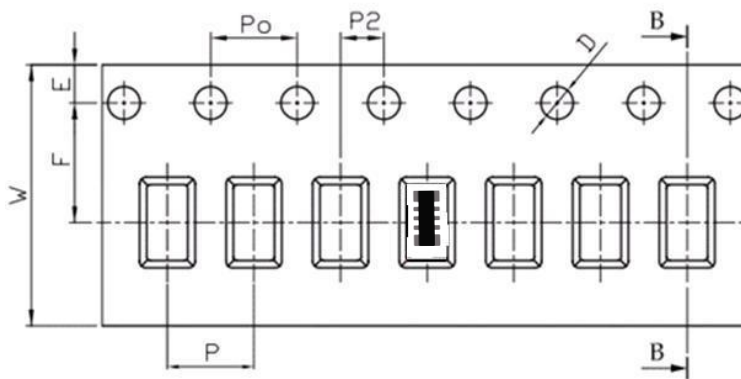

Feature	Specifications	Tolerances
W	12.00	± 0.30
P	4.00	± 0.10
E	1.75	± 0.10
F	5.50	± 0.10
P2	2.00	± 0.10
D	1.50	+0.10 -0.00
P ₀	4.00	± 0.10
10P ₀	40.00	± 0.20

Typing Quantity: 5000 pieces per 7" reel