

2.4GHz 3216 Chip Antenna: RANT3216F245C03



Application:

WLAN, 802.11b/g, Bluetooth, WLAN, etc...

Features

SMD, high reliability, ultra Impact, Omni-directional...



Part number Information

RANT 3216 F 245 C 03
(A) (B) (C) (D) (E) (F)

| | |
|------------------|-----------------------|
| (A) Product Type | Chip Antenna |
| (B) Size Code | 3.2x1.6mm(±0.2mm) |
| (C) Material | High K material |
| (D) Frequency | 2.4 ~ 2.5GHz |
| (E) Feeding mode | PIFA & Single Feeding |
| (F) Antenna type | Type=03 |

Electrical Specification

| | |
|-------------------------------|--------------------|
| Working Frequency Range | 2400 ~2500 MHz |
| Bandwidth | 120 MHz (Min.) |
| Peak Gain | 1.24 dBi (Typ.) |
| Impedance | 50 Ohm |
| Return loss | 10 dB (Min) |
| Polarization | Linear |
| Azimuth Beamwidth | Omni-directional |
| Operation Temperature(°C) | -40 ~85°C |
| Resistance to Soldering Heats | 10sec. (@ 280°C) |
| Termination | Ni / Au (Leadless) |

The specification is defined on EVB.

Dimension and Terminal Configuration

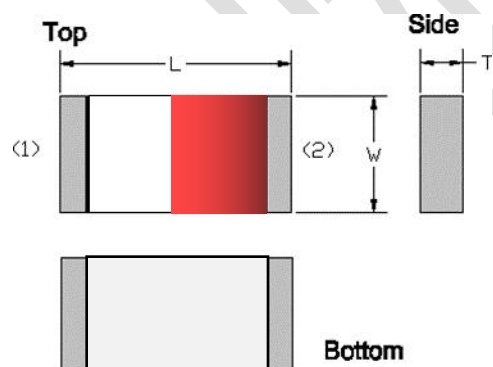

| Dimension (mm) | |
|----------------|-------------|
| L | 3.20 ± 0.20 |
| W | 1.60 ± 0.20 |
| T | 0.45 ± 0.20 |

| No. | Terminal Name |
|-----|---------------|
| 1 | Feeding/GNG |
| 2 | GND/Feeding |

咏成國際科技有限公司

13530576606

709, Building F, Yuxing Science and Technology Industrial Park, Nanchang Third Industrial Zone, Nanchang Community, Xixiang Street, Bao'an District, Shenzhen

電話：



Evaluation Board Reference

| 长条板PCB 推荐 Dimension | 圆板Antenna Layout Reference |
|---------------------------|--|
| | <p style="text-align: right;">Unit :mm</p> |

Electrical Characteristics

Return Loss & Radiation

Return Loss

| Frequency (GHz) | Return Loss (dB) |
|-----------------|------------------|
| 2.400000000 | -10.502 |
| 2.450000000 | -30.620 |
| 2.500000000 | -11.472 |

| Frequency(MHz) | S11 (dB) |
|----------------|----------|
| 2400 | -10.50 |
| 2450 | -30.62 |
| 2500 | -11.47 |

2.4GHz 3216 Chip Antenna: RANT3216F245C03

Radiation

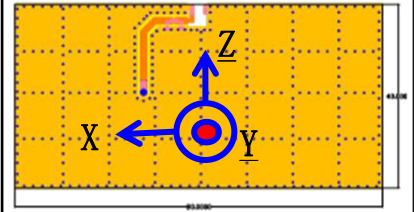
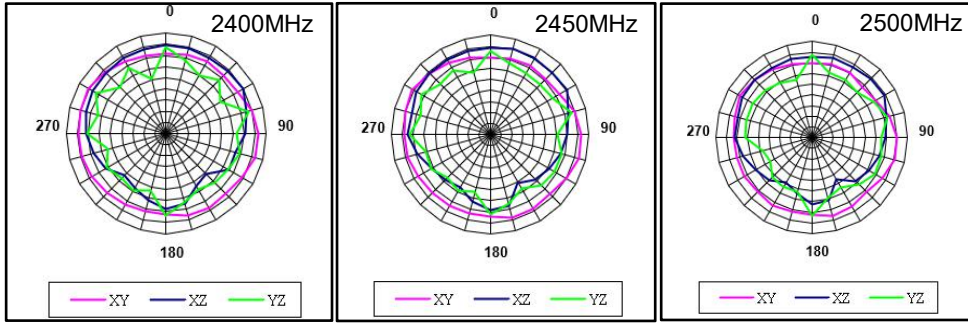

| | 2400MHz | 2450MHz | 2500MHz |
|-------------|----------|----------|----------|
| Efficiency | 82.52% | 85.26% | 83.01% |
| Peak Gain | 1.15 dBi | 1.24 dBi | 1.19 dBi |
| Directivity | 1.89 dBi | 1.97 dBi | 1.91 dBi |

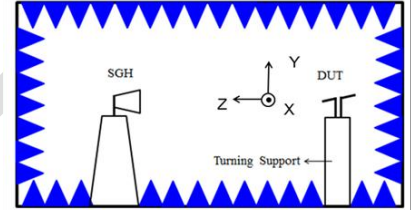

威成國際

Taping Specifications

Reel and Taping Specification

Reel Specification

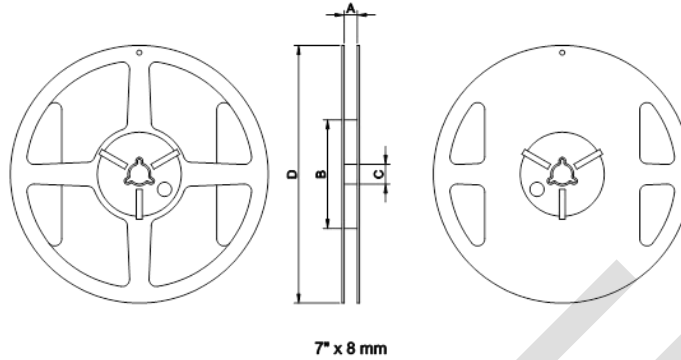

| TYPE | SIZE | | A | B | C | D |
|------|------|---------|---------|------|----------|-------|
| 3216 | 7" | 5K/Reel | 9.0±0.5 | 60±2 | 13.5±0.5 | 178±2 |

Tapping Specification

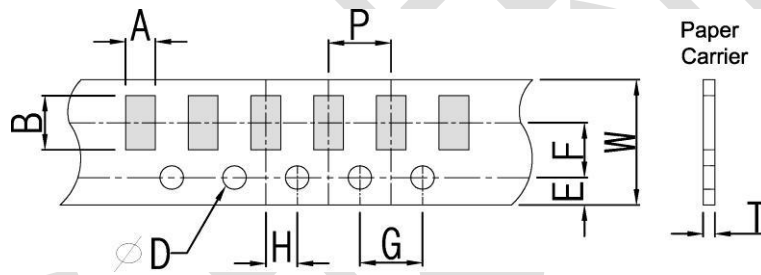

| Packaging | Type | A | B | W | E | F | G | H | T | ψD | P |
|------------|------|---------------|---------------|--------------|---------------|----------|----------|----------|---------------|---------------|---------|
| Paper Type | 3216 | 1.90±0.2 0 | 3.50±0.2 0 | 8.0±0.2 0 | 1.75±0.1 0 | 3.5±0.05 | 4.0±0.10 | 2.0±0.05 | 0.75±0.1 0 | 1.50±0.1 0 | 4.0±0.1 |

2.4GHz 3216 Chip Antenna: RANT3216F245C03



Reliability Table

| Test Item | Procedure | Requirements Ceramic Type | Remark (Reference) |
|--|--|---|---------------------------|
| Electrical Characterization | | Fulfill the electrical specification | User Spec. |
| Thermal Shock | <ol style="list-style-type: none"> Preconditioning: 50 ± 10°C / 1 hr , then keep for 24 ± 1 hrs at room temp. Initial measure: Spec: refer Initialspec. Rapid change of temperature test: -30°C to +85°C; 100 cycles; 15 minutes at Lower category temperature; 15 minutes at Upper category temperature. | No Visible Damage. Fulfill the electrical specification. | MIL-STD-202 107 |
| Temperature Cycling | <ol style="list-style-type: none"> Initial measure: Spec: refer Initialspec. 100 Cycles (-30°C to +85°C), Soak Mode=1 (2 Cycle/hours). Measurement at 24 ± 2Hours after test condition. | No Visible Damage. Fulfill the electrical specification. | JESD22 JA104 |
| High Temperature Exposure | <ol style="list-style-type: none"> Initial measure: Spec: refer Initialspec. Unpowered; 500hours @ T=+85°C. Measurement at 24 ± 2 hours aftertest. | No Visible Damage. Fulfill the electrical specification. | MIL-STD-202 108 |
| Low Temperature Storage | <ol style="list-style-type: none"> Initial measure: Spec: refer Initialspec. Unpowered: 500hours @ T=-30°C. Measurement at 24 ± 2 hours aftertest. | No Visible Damage. Fulfill the electrical specification. | MIL-STD-202 108 |
| Solderability (SMD Bottom Side) | Dipping method: <ol style="list-style-type: none"> Temperature: 235 ± 5°C Dipping time: 3 ± 0.5s | The solder should cover over 95% of the critical area of bottom side. | IEC 60384-21/22 4.10 |
| Soldering Heat Resistance (RSH) | Preheating temperature: 150 ± 10°C. Preheating time: 1~2 min. Solder temperature: 260 ± 5°C. Dipping time: 5 ± 0.5s | No Visible Damage. | IEC 60384-21/22 4.10 |
| Vibration | 5g's for 20 min., 12 cycles each of 3 orientations Note: Use 8"X5" PCB .031" thick 7 secure points on, one long side and 2 secure points at corners of opposite sides. Parts mounted within 2" from any secure point. Test from 10-2000 Hz. | No Visible Damage. | MIL-STD-202 Method 204 |
| Mechanical Shock | Three shocks in each direction shall be applied along the three mutually perpendicular axes of the test specimen (18 shocks) Peak value: 1,500g's Duration: 0.5ms Velocity change: 15.4 ft/s Waveform: Half-sine | No Visible Damage. | MIL-STD-202 Method 213 |
| Humidity Bias | <ol style="list-style-type: none"> Humidity: 85% R.H., Temperature: 85 ± 2 °C. Time: 500 ± 24 hours. Measurement at 24 ± 2hrs after test condition. | No Visible Damage. Fulfill the electrical specification. | MIL-STD-202 Method 106 |

2.4GHz 3216 Chip Antenna: RANT3216F245C01

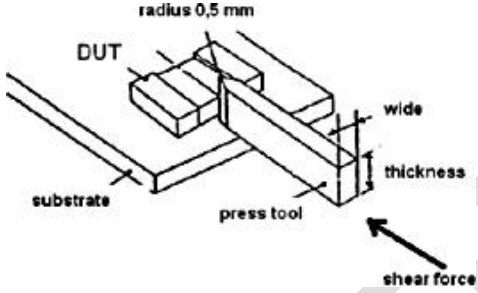
| | | | |
|---------------------------|---|--|---------------------|
| Board Flex (SMD) | <p>1. Mounting method: IR-Reflow. PCB Size (L:100 × W:40 × T:1.6mm)</p> <p>2. Apply the load in direction of the arrow until bending reaches 2 mm.</p> | <p>No Visible Damage.</p> | <p>AEC-Q200 005</p> |
| Adhesion | <p>Force of 1.8Kg for 60 seconds.</p>  | <p>No Visible Damage Magnification of 20X or greater may be employed for inspection of the mechanical integrity of the device body terminals and body/terminal junction.</p> | <p>AEC-Q200 006</p> |
| Physical Dimension | <p>Any applicable method using x10 magnification, micrometers, calipers, gauges, contour projectors, or other measuring equipment, capable of determining the actual specimen dimensions.</p> | <p>In accordance with specification.</p> | <p>JESD22 JB100</p> |

Revision History

| Revision | Date | Content |
|----------|------------|---------------------------------|
| 1 | 2019/03/01 | New Datasheet |
| 2 | 2020/02/22 | Add 2D radiation characteristic |

| Test Result | Bluetooth TIS | | |
|-------------------|---------------|--------|--------|
| Frequency (MHz) | 2402 | 2441 | 2480 |
| TIS (dBm) | -85.65 | -85.87 | -85.83 |
| MHPIS (dBm) 45 | -85.65 | -85.87 | -85.83 |
| BSSI Ave | 1.26 | 0.36 | 0.11 |
| MaxPosRSSI | 3.37 | 2.59 | 2.26 |
| MaxPosSens | -87.77 | -88.1 | -87.97 |
| MAX (dBm) | 3.65 | 3.04 | 2.9 |
| EIS peak | 3.65 | 3.04 | 2.9 |
| Min (dBm) | -8.01 | -9.44 | -9.05 |
| Attenuation Horiz | 44.27 | 44.1 | 44.47 |
| Attenuation Vert | 43.77 | 43.6 | 44.03 |

| Application Information | |
|-------------------------|--------------|
| O4Version | 5.245.351 |
| TotalTime | 7m 57s 515ms |
| AdditionalInfor | 4142869711CE |

Bluetooth TIS

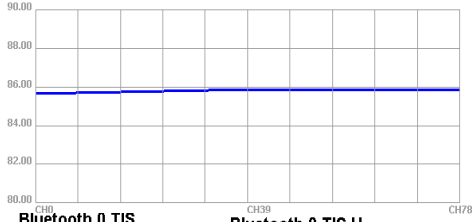

Bluetooth 0 TIS

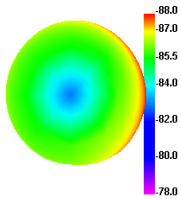

Bluetooth 0 TIS H

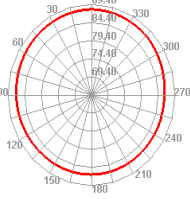

Bluetooth 0 TIS E1

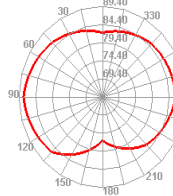

Bluetooth 0 TIS E2

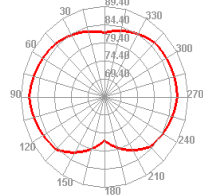

Bluetooth 39 TIS

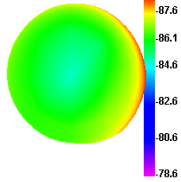

Bluetooth 39 TIS H

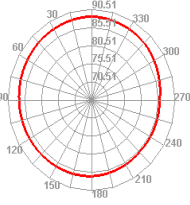

Bluetooth 39 TIS E1

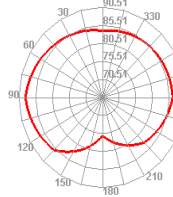

Bluetooth 39 TIS E2

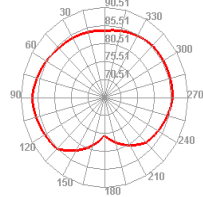

Bluetooth 78 TIS

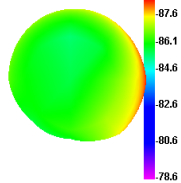

Bluetooth 78 TIS H

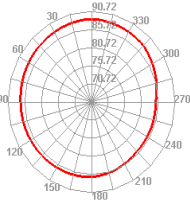

Bluetooth 78 TIS E1

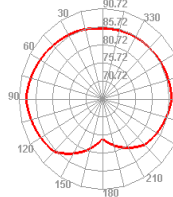

Bluetooth 78 TIS E2

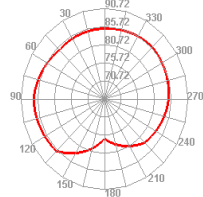

| Test Result | Bluetooth TRP | | |
|-------------------|---------------|-------|-------|
| | 0 | 39 | 78 |
| Frequency (MHz) | 2402 | 2441 | 2480 |
| TRP (dBm) | 1.26 | 0.36 | 0.11 |
| MHPRP (dBm) 45 | 1.26 | 0.36 | 0.11 |
| MAX (dBm) | 3.65 | 3.04 | 2.9 |
| EIRP peak | 3.65 | 3.04 | 2.9 |
| Min (dBm) | -8.01 | -9.44 | -9.05 |
| Attenuation Horiz | 44.27 | 44.1 | 44.47 |
| Attenuation Verti | 43.77 | 43.6 | 44.03 |

| Application Information | |
|-------------------------|--------------|
| O4Version | 5.245.351 |
| TotalTime | 7m 57s 515ms |
| AdditionalInfor | 4142869711CE |

Bluetooth TRP

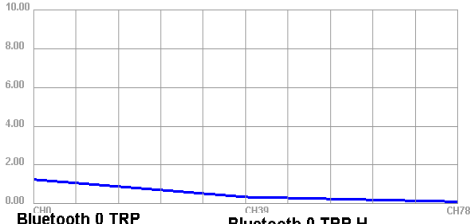

Bluetooth 0 TRP

Bluetooth 0 TRP H

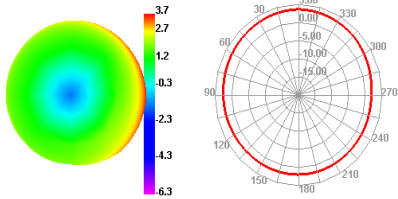

Bluetooth 0 TRP E1

Bluetooth 0 TRP E2

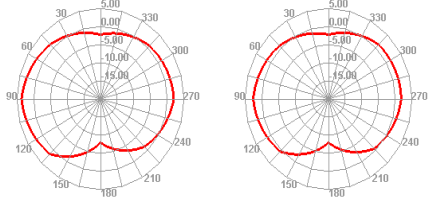

Bluetooth 39 TRP

Bluetooth 39 TRP H

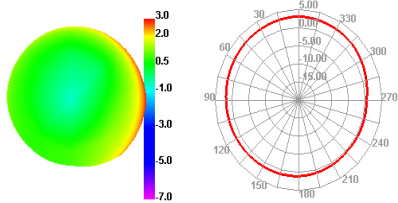

Bluetooth 39 TRP E1

Bluetooth 39 TRP E2

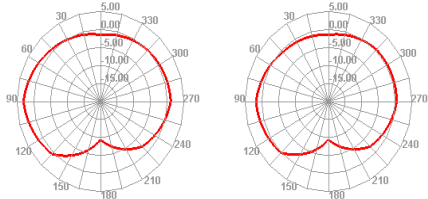

Bluetooth 78 TRP

Bluetooth 78 TRP H

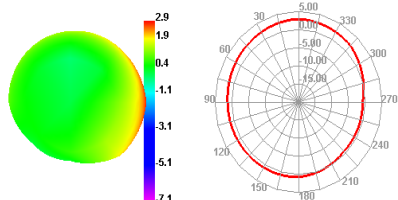

Bluetooth 78 TRP E1

Bluetooth 78 TRP E2

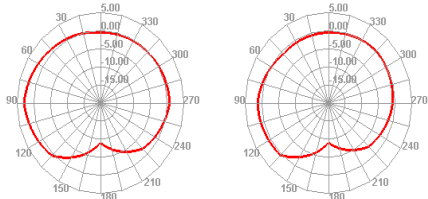

| Test Result | Bluetooth TIS | | |
|-------------------|---------------|--------|--------|
| Frequency (MHz) | 2402 | 2441 | 2480 |
| TIS (dBm) | -86.42 | -86.45 | -86.31 |
| MHPIS (dBm) 45 | -86.42 | -86.45 | -86.31 |
| BSSI Ave | 1.52 | 0.62 | 0.28 |
| MaxPosRSSI | 3.37 | 2.77 | 2.44 |
| MaxPosSens | -88.27 | -88.6 | -88.47 |
| MAX (dBm) | 3.62 | 3.04 | 2.78 |
| EIS peak | 3.62 | 3.04 | 2.78 |
| Min (dBm) | -10.23 | -11.66 | -11.03 |
| Attenuation Horiz | 44.27 | 44.1 | 44.47 |
| Attenuation Vert | 43.77 | 43.6 | 44.03 |

| Application Information | |
|-------------------------|--------------|
| 04Version | 5.245.351 |
| TotalTime | 7m 57s 930ms |
| AdditionalInfor | 4142869711CE |

Bluetooth TIS

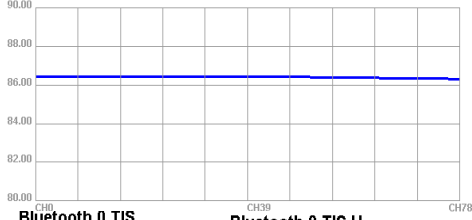

Bluetooth 0 TIS

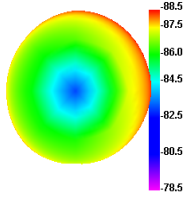

Bluetooth 0 TIS H

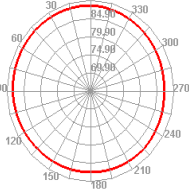

Bluetooth 0 TIS E1

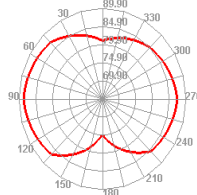

Bluetooth 0 TIS E2

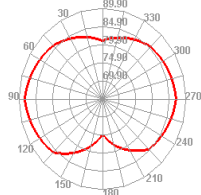

Bluetooth 39 TIS

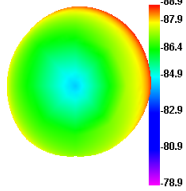

Bluetooth 39 TIS H

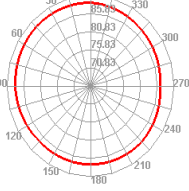

Bluetooth 39 TIS E1

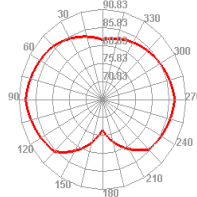

Bluetooth 39 TIS E2

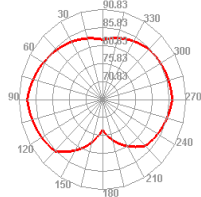

Bluetooth 78 TIS

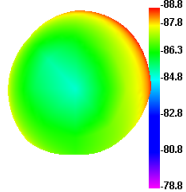

Bluetooth 78 TIS H

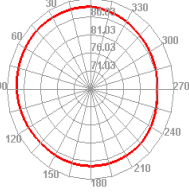

Bluetooth 78 TIS E1

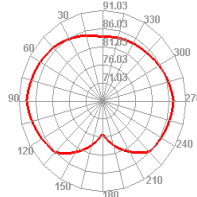

Bluetooth 78 TIS E2

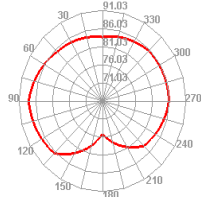

| Test Result | Bluetooth TRP | | |
|-------------------|---------------|--------|--------|
| | 0 | 39 | 78 |
| Frequency (MHz) | 2402 | 2441 | 2480 |
| TRP (dBm) | 1.52 | 0.62 | 0.28 |
| MHPRP (dBm) 45 | 1.52 | 0.62 | 0.28 |
| MAX (dBm) | 3.62 | 3.04 | 2.79 |
| EIRP peak | 3.62 | 3.04 | 2.79 |
| Min (dBm) | -10.23 | -11.66 | -11.03 |
| Attenuation Horiz | 44.27 | 44.1 | 44.47 |
| Attenuation Verti | 43.77 | 43.6 | 44.03 |

| Application Information | |
|-------------------------|--------------|
| O4Version | 5.245.351 |
| TotalTime | 7m 57s 930ms |
| AdditionalInfor | 4142869711CE |

Bluetooth TRP

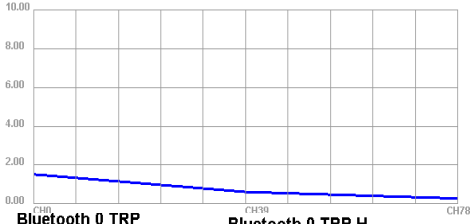

Bluetooth 0 TRP

Bluetooth 0 TRP H

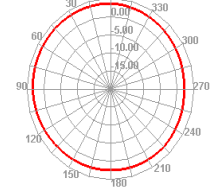
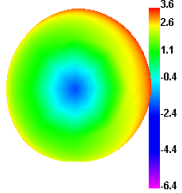

Bluetooth 0 TRP E1

Bluetooth 0 TRP E2

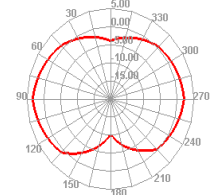
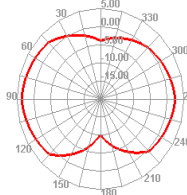

Bluetooth 39 TRP

Bluetooth 39 TRP H

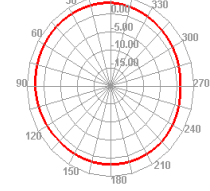
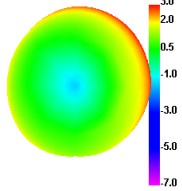

Bluetooth 39 TRP E1

Bluetooth 39 TRP E2

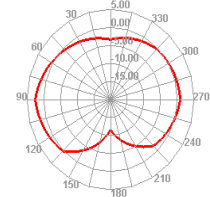
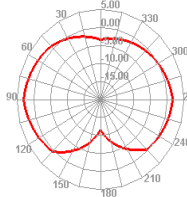

Bluetooth 78 TRP

Bluetooth 78 TRP H

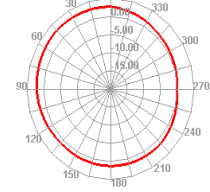
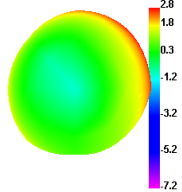

Bluetooth 78 TRP E1

Bluetooth 78 TRP E2

