



**Thales Canada,
Transportation Solutions**
105 Moatfield Drive, Suite 100,
Toronto, Ontario
Canada
Tel. +1 416 742 3900
Fax. + 1 416 742 1136
www.thalesgroup.com

COMTRAC RADIO

USER MANUAL

Business Entity Identifier	Business Identifier	DTC	Revision
9950-15900	3CU 04036 0026 PCZZA	108	0A

REVISION HISTORY

LOG OF CHANGES			
Revision	Date	Author	Modification
0A	5-Dec-2018	D. Cammidge	Initial Draft

Business Entity Identifier	Business Identifier	DTC	Revision
9950-15900	3CU 04036 0026 PCZZA	108	0A

CONFIDENTIAL © Thales Canada, Transportation Solutions. All rights reserved. Passing on or copying of this document, use or communication of its content in whole or in part is not permitted without prior written authorization.

TABLE OF CONTENTS

1.	INTRODUCTION	5
	1.1 Scope and Purpose	5
	1.2 Target Audience	5
	1.3 Acronyms	5
	1.4 References	6
	1.5 WARNING	6
2.	OVERVIEW	7
	2.1 Modes of Operation	8
	2.1.1 Access Point	8
	2.1.2 Client	8
3.	SOFTWARE / CONFIGURATION INSTALLATION	9
	3.1 Local Download Procedure	9
	3.2 Remote Download Procedure	9
4.	PHYSICAL INTERFACES – STANDALONE VARIANT	10
	4.1 Console Ports	10
	4.2 Discrete IO Port	10
	4.3 Ethernet Ports	11
	4.4 Fiber (SFP) Ports	11
	4.5 Power Interface	12
	4.6 RF Ports	13
	4.7 USB Ports	13
5.	PHYSICAL INTERFACES – DIE-CAST VARIANT	14
	5.1 Console Ports	14
	5.2 Ethernet Port	15
	5.3 Fiber Ports	16
	5.4 Power Interface	17
	5.5 RF Port	18
	5.6 USB Ports	18
6.	STATUS INDICATORS – STANDALONE UNIT	19
	6.1 Status Fault Indicator	19
	6.2 Ethernet Ports	19
	6.3 Wireless Network Links	20
7.	STATUS INDICATORS – DIE-CAST UNIT	21
	7.1 Status Fault Indicator	21
	7.2 Wireless Network Links	21

Business Entity Identifier	Business Identifier	DTC	Revision
9950-15900	3CU 04036 0026 PCZZA	108	0A

COMTRAC RADIO
USER MANUAL

8.	MAINTENANCE	22
9.	SAFETY	23
10.	INSTALLATION	24
	10.1 Standalone Unit	24
	10.2 Die-cast Unit	26
11.	EMC CONSIDERATIONS	27
12.	DEPLOYMENT CONSIDERATIONS	28
	12.1 Wayside Radio Unit	29
	12.1.1 Access Point Power Setting	30
	12.2 Mobile Radio Unit	31
	12.2.1 Mobile Power Setting	31
	12.2.2 Antenna Diversity	32
13.	REGULATORY COMPLIANCE NOTES	33
	APPENDIX A LABELLING INFORMATION	36

LIST OF FIGURES

Figure 1	Typical Radio Application	7
Figure 2	Mounting Dimension - Standalone Unit	25
Figure 3	Mounting Dimensions - Die-cast Unit	26
Figure 4	Access Point Radio Installation – Two Antennas	29
Figure 5	Access Point Radio Installation – Four Antennas	29
Figure 6	Mobile Radio Installation	31

Business Entity Identifier	Business Identifier	DTC	Revision
9950-15900	3CU 04036 0026 PCZZA	108	0A

CONFIDENTIAL © Thales Canada, Transportation Solutions. All rights reserved. Passing on or copying of this document, use or communication of its content in whole or in part is not permitted without prior written authorization.

1. INTRODUCTION

1.1 Scope and Purpose

This document is intended to provide an overview of the ComTrac Radio as well as basic information regarding installation. It is intended to be submitted as an artifact for regulatory compliance.

1.2 Target Audience

The ComTrac Radio is an industrial grade device and not a consumer product. This manual is designed to be used by qualified technical support personnel with experience in the rail signalling environment.

1.3 Acronyms

AC	Alternating Current
AP	Access Point
ARP	Address Resolution Protocol
CBTC	Communication Based Train Control
dBi	decibel isotropic
dBm	decibel milliwatts
DC	Direct Current
EIRP	Effective Isotropic Radiated Power
EMC	Electromagnetic Compatibility
ESSID	Extended Service Set Identifier
FHSS	Frequency-Hopping Spread Spectrum
GND	Ground
ID	Identifier
IP	Ingress Protection
LAN	Local Area Network
LED	Light Emitting Diode
n/a	Not Applicable
MR	Mobile Radio
MRU	Mobile Radio Unit
PFSE	Power Fiber Splice Enclosure
SFP	Small Form-factor Pluggable
TCTS	Thales Canada Transportation Solutions

Business Entity Identifier	Business Identifier	DTC	Revision
9950-15900	3CU 04036 0026 PCZZA	108	0A

CONFIDENTIAL © Thales Canada, Transportation Solutions. All rights reserved. Passing on or copying of this document, use or communication of its content in whole or in part is not permitted without prior written authorization.

QoS	Quality of Service
USB	Universal Serial Bus
WRU	Wayside Radio Unit

1.4 References

[1] 3CU 04036 0027 PCZZA ComTrac Radio Technician Guide

1.5 WARNING

Warnings are used throughout this document to emphasize important and critical information.





COMPLY WITH ALL EXISTING ELECTRICAL WARNING SIGNS.



WARNING

Warnings identify an installation, operating, maintenance procedure or statement that, if not strictly followed could result in death or serious injury to personnel, and/or damage to equipment.

The following graphic symbols may be used with Warnings and Cautions in Thales Canada, Transportation Solutions (TCTS) documents:

	Caution or Warning
	Laser Radiation
	High Voltage
	Hot Surface

Business Entity Identifier	Business Identifier	DTC	Revision
9950-15900	3CU 04036 0026 PCZZA	108	0A

CONFIDENTIAL © Thales Canada, Transportation Solutions. All rights reserved. Passing on or copying of this document, use or communication of its content in whole or in part is not permitted without prior written authorization.

2. OVERVIEW

The ComTrac Radio is used as a telecommunication device within the context of Communication Based Train Control (CBTC) System. The radio incorporates the 802.11 FHSS standard to provide radio-to-radio communication using the unlicensed 2.4GHz spectrum in a mobile environment. It also provides fiber and LAN connectivity to pass data traffic from wayside to on-board networks.

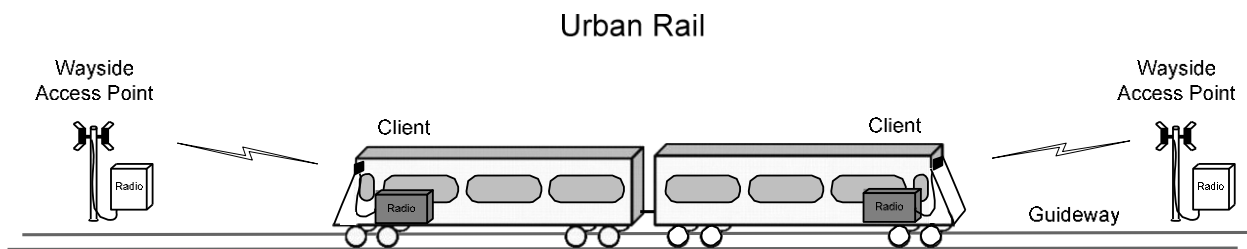

Figure 1 Typical Radio Application

There are two styles of the radio; a standalone unit and a die-cast unit. The standalone can be configured for all modes of operation. The die-cast is intended to be used as an access point only.

The term 'radio' is interchangeable with 'ComTrac Radio', 'access point' (AP), or 'mobile radio' (MR) within the context of this document.

Also, the term 'client' is interchangeable with mobile radio (MR), and the 'Wayside Radio Unit' (WRU) is interchangeable with access point.

Business Entity Identifier	Business Identifier	DTC	Revision
9950-15900	3CU 04036 0026 PCZZA	108	0A

2.1 Modes of Operation

2.1.1 Access Point

An access point (AP) is a mode of operation that allows connectivity, through bridging, from a wired local area network (LAN) to one or more clients.

To setup the radio in AP mode requires the AP configuration file to be selected. Refer to the Configuration section in [1] for further details.

2.1.2 Client

The client is an operational mode which provides wireless communication from the AP to its wired LAN(s), and is responsible to initiate roaming between AP's.

To setup the radio in client mode, requires the mobile radio configuration file to be selected. Refer to the Configuration section in [1] for further details.

Business Entity Identifier	Business Identifier	DTC	Revision
9950-15900	3CU 04036 0026 PCZZA	108	0A

3. SOFTWARE / CONFIGURATION INSTALLATION

There are two methods to download software and configuration to the radio, a local method where physical connectivity to the radio is available, and a remote method, such as on a network.

3.1 Local Download Procedure

This method requires a console connection to the administration port, as well as a USB drive formatted with FAT32 file system.

This procedure may be used to update the software and/or configuration files.

Refer to [1] for procedure.

3.2 Remote Download Procedure

This method requires that the loader laptop or PC has access to a network connection, and there is connectivity to the radio requiring the upgrade.

This procedure may be used to update the software and/or configuration files.

Refer to [1] for procedure.

Business Entity Identifier	Business Identifier	DTC	Revision
9950-15900	3CU 04036 0026 PCZZA	108	0A

CONFIDENTIAL © Thales Canada, Transportation Solutions. All rights reserved. Passing on or copying of this document, use or communication of its content in whole or in part is not permitted without prior written authorization.

4. PHYSICAL INTERFACES – STANDALONE VARIANT

4.1 Console Ports

A console port is provided for each side. Side-A is interfaced through ADMIN-A, and the side-B is interfaced through ADMIN-B.

The console interface uses a standard female DB9. The pin-outs are listed below.

When using a USB to serial adaptor, it is recommended to keep the serial cable portion as short as possible.

DB-9 Female Connector Pin Out	RS-232 Signal
1	Not Connected
2	RxD
3	TxD
4	DTR
5	Signal Ground
6	DSR
7	RTS
8	CTS
9	Not Connected

Console Port	Default Port Settings
Bits Per Second	115200
Data Bits	8
Parity	None
Stop Bits	1
Flow Control	None

4.2 Discrete IO Port

The discrete Input Output (IO) port, labelled AUX is currently not supported.

Business Entity Identifier	Business Identifier	DTC	Revision
9950-15900	3CU 04036 0026 PCZZA	108	0A

4.3 Ethernet Ports

These ports are shielded, RJ-45 ports that supports 10BaseT / 100BaseT / 1000BaseT Ethernet network connectivity. Short-circuit protection and 1500Vrms isolation is supported.

There are four ports per side;

A-side has connectivity to the ports labelled 1-A thru 4-A.

B-side has connectivity to the ports labelled 1-B thru 4-B.

4.4 Fiber (SFP) Ports

The radio contains two SFP slots. Ensure the transceiver modules are securely inserted and latched. The release bar should be in the down position.

To connect the transceivers from one radio to another, cross-connect the transmit channel at each end to the receive channel at the opposite end, as shown below.

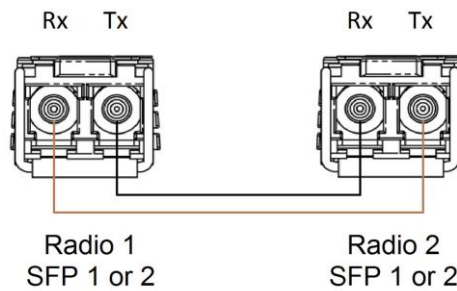

The supported transceivers are:

Fiber Type	Wavelength (nm)	TCTS Part Number	Comments
Single Mode (SM)	1310	300-3-02363	Recommended for new installations
Single Mode (SM)	1310	300-3-02089	
Multi-Mode (SM)	1310	300-3-02090	

Business Entity Identifier	Business Identifier	DTC	Revision
9950-15900	3CU 04036 0026 PCZZA	108	0A

4.5 Power Interface

The power port is label as '12 VDC' and requires between 9-14Vdc to operate, with a minimum input current rating of 3A @12V. There is reverse polarity protection.

The 'pin' on the radio is the positive connection, and the 'socket' negative.

DSUB Female Connector Pin Out	12VDC
1 (pin)	+Vdc
2 (socket)	-Vdc

The absolute maximum input voltage is 15V.

The -Vdc is electrically connected to chassis.

The following is a list of the suggested mating connector parts;

Item:	TCTS P/N:	Thales Description:	Manufacturer / P/N:
Mating Connector	702-3-1561	CON-SHELL DESUB 2 PIN FML 2W2C	Conec / 302W2CPXX99A10X
Backshell	702-3-01070-A	CON-BACKSHELL DE9 EMI	Conec / 165X13469X
Pin	702-3-01080	CONTACT-CRIMP MALE 16-20 AWG	Conec / 131C11019X
Socket	702-3-01081	CONTACT-CRIMP FEMALE 16-20 AWG	Conec / 132C11019X

Business Entity Identifier	Business Identifier	DTC	Revision
9950-15900	3CU 04036 0026 PCZZA	108	0A

CONFIDENTIAL © Thales Canada, Transportation Solutions. All rights reserved. Passing on or copying of this document, use or communication of its content in whole or in part is not permitted without prior written authorization.

4.6 RF Ports

There are four RF N-type female, 50 ohm connectors, labelled below.
For CBTC implementation, the following default antenna ports are identified below.

RF Port	STA	AP
ANT 1	Not used	Not used
ANT 2	Not used	Not used
ANT 3	Diversity (modem-0)	Main Antenna
ANT 4	Diversity (modem-1)	Not used

To avoid radio receiver saturation, the maximum input signal level to the radio should not exceed -10dBm. The absolute maximum continuous input power is +10dBm.

4.7 USB Ports

The Universal Serial Bus (USB) port is a shielded USB Standard A port that provides connectivity for USB-A port and USB-B port. The interface supports USB 1.0 and 2.0 compliant storage devices, formatted with FAT32 file system.

Note: Not all USB thumb drives are supported.

Business Entity Identifier	Business Identifier	DTC	Revision
9950-15900	3CU 04036 0026 PCZZA	108	0A

5. PHYSICAL INTERFACES – DIE-CAST VARIANT

5.1 Console Ports

The console ports are located underneath the removable face plate.

A console port is provided for each side. Side-A is interfaced through ADMIN-A, and the side-B is interfaced through ADMIN-B.

The console interface uses a standard female DB9. The pin-outs are listed below.

When using a USB to serial adaptor, it is recommended to keep the serial cable portion as short as possible.

DB-9 Female Connector Pin Out	RS-232 Signal
1	Not Connected
2	RxD
3	TxD
4	DTR
5	Signal Ground
6	DSR
7	RTS
8	CTS
9	Not Connected

Console Port	Default Port Settings
Bits Per Second	115200
Data Bits	8
Parity	None
Stop Bits	1
Flow Control	None

Business Entity Identifier	Business Identifier	DTC	Revision
9950-15900	3CU 04036 0026 PCZZA	108	0A

5.2 Ethernet Port

This port is labeled on the top of the unit as 'ETHERNET'.

The interface is an M12 D-coded female connector that supports 10BaseT / 100BaseT Ethernet network connectivity. Short-circuit protection and 1500Vrms isolation is supported. It also supports a mating connector with a push-pull or threaded locking mechanism.

In reference to the Standalone radio, this interface is internally connected to port 3-A, using a straight-through cable.

The following shows the pin-out as well as the signal definition.

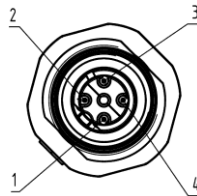

M12 Pin #:	I/O Label
1	Tx+
2	Rx+
3	Tx-
4	Rx-

The following table identifies patch cables to be used for maintenance purposes.

Item:	TCTS P/N:
Cable Assembly, 2m, M12 to RJ45 CAT5E	403-3-00905
Cable Assembly, 5m, M12 to RJ45 CAT5E	403-3-00677

Business Entity Identifier	Business Identifier	DTC	Revision
9950-15900	3CU 04036 0026 PCZZA	108	0A

5.3 Fiber Ports

There is one connector which contains two fiber interfaces, and is labelled 'FIBER' on the top of the unit.

The connector is a Harting Han[®] 3 A with a locking feature, and uses an insert.

In reference to the Standalone radio, this interface is internally connected to the SFP ports, using a fiber cable. Type of fiber is dependent on the variant of die-cast unit.

The following shows the pin-out as well as the signal definition.

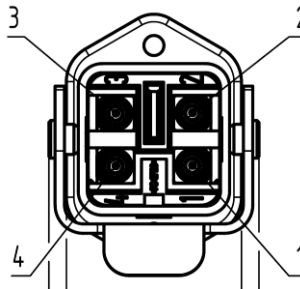

Fiber Port Pin #	I/O Label (ref. Standalone radio)
1	SFP 2, Tx
2	SFP 2, Rx
3	SFP 1, Tx
4	SFP 1, Rx

The following identifies patch cable to be used between the radio and the PFSE;

Item:	TCTS P/N:
Cable Assembly, SM SC/4X LC SPX, 1.5m	403-3-00986

Business Entity Identifier	Business Identifier	DTC	Revision
9950-15900	3CU 04036 0026 PCZZA	108	0A

COMTRAC RADIO
USER MANUAL

5.4 Power Interface

The power port is label as 'AC POWER INPUT' on the top of the unit.

The connector is a Harting series Han[®] 4 A, with a locking feature, and uses a 4 position (male) insert.

The following indicates the pin-out as well as the signal definition.

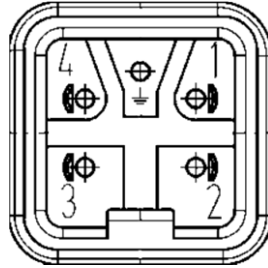

Power Connector Pin #	120-240Vac
1	Line
2	(no connect)
3	(no connect)
4	Neutral
GND	GND

The following table identifies a 1.5 meter power cable assembly using flexible conduit to be used between the radio and the PFSE. It also identifies parts to create a bench or lab cable (wire not specified).

Item:	TCTS P/N:	Manufacturer / P/N:
Cable Assembly	403-3-00985	Harting: 33520121500001
Insert, with pins	702-3-02147	Harting: 09 20 004 2611
Back shell (black)		Harting: 19 37 003 1440
Cable gland, M20		Harting: 19 00 000 51 55

Nominal input level is 100/240 Vac, 50/60Hz.

Operation voltage level is between 85-264Vac 47/63Hz.

The power interface is protected by an external, 5x20mm, replaceable fuse with a rating of 3.15A 250V time-lag. TCTS part number for a replacement fuse is 600-3-00326.

Business Entity Identifier	Business Identifier	DTC	Revision
9950-15900	3CU 04036 0026 PCZZA	108	0A

CONFIDENTIAL © Thales Canada, Transportation Solutions. All rights reserved. Passing on or copying of this document, use or communication of its content in whole or in part is not permitted without prior written authorization.

5.5 RF Port

There is one RF port located at the side of the unit, and is labeled as ANT-1 on the top of the unit. There is a series internal bandpass filter, which provides rejection for frequencies outside of the 2.4 GHz band. Refer to the Specification section for the RF characteristics.

The RF port is an N-type female connector.

5.6 USB Ports

The Universal Serial Bus (USB) ports are located underneath the removable face plate.

The USB port is a shielded USB Standard A port that provides connectivity for USB-A port and USB-B port. The interface supports USB 1.0 and 2.0 compliant storage devices, formatted with FAT32 file system.

Note: Not all USB thumb drives are supported.

Business Entity Identifier	Business Identifier	DTC	Revision
9950-15900	3CU 04036 0026 PCZZA	108	0A

CONFIDENTIAL © Thales Canada, Transportation Solutions. All rights reserved. Passing on or copying of this document, use or communication of its content in whole or in part is not permitted without prior written authorization.

6. STATUS INDICATORS – STANDALONE UNIT

6.1 Status Fault Indicator

The Status Fault LED indicator is used to indicate the operational status of the radio as indicated in the following table. It is located on the front and center of the unit, and is labelled as STATUS.

STATUS LED	Description
LED is Green	Radio is powered on and operating
LED is Orange	Radio is in a boot-up state
LED is Red	Radio is in a fault state

6.2 Ethernet Ports

The LED status indicator states for the RJ-45 Ethernet ports are listed below.

RJ-45 Port LED	Description
LED is off	No RJ-45 electrical connectivity <ul style="list-style-type: none"> - Cable disconnected - Port speed mismatched
LED is on solid	Link has electrical connectivity with no data transfer.
LED flashing	Link has electrical connectivity with data transfer.

Business Entity Identifier	Business Identifier	DTC	Revision
9950-15900	3CU 04036 0026 PCZZA	108	0A





CONFIDENTIAL © Thales Canada, Transportation Solutions. All rights reserved. Passing on or copying of this document, use or communication of its content in whole or in part is not permitted without prior written authorization.

6.3 Wireless Network Links

The wireless network link uses a series of LEDs to indicate status. Only the yellow bank of LEDs is currently utilized, which is located underneath ANT 4. The green bank of LEDs is not functional.

The following provides a description of their usage.

LED Identifier	STA / AP	Description
Bar Graph Symbol	STA only	Wireless signal strength – refer to bar graph chart below
MODE	All	Off = wireless not configured Flashing 50% duty cycle; 1 sec interval = Client ½ sec interval = Access Point
ASSOC	STA only	Wireless association state. ON when STA is associated
TxRx	All	Wireless Tx/Rx activity.
SEC	n/a	Not currently implemented

Bar Graph	Approximate Signal Level Range (dBm)
	< -85
	-85 to -65
	-65 to -45
	-45 to -25
	> -25

Business Entity Identifier	Business Identifier	DTC	Revision
9950-15900	3CU 04036 0026 PCZZA	108	0A

7. STATUS INDICATORS – DIE-CAST UNIT

7.1 Status Fault Indicator

The Status Fault LED indicator is used to indicate the operational status of the radio as indicated in the following table. It is located on the front and center of the unit, and is labelled as STATUS.

STATUS LED	Description
LED is Green	Radio is powered on and operating
LED is Orange	Radio is in a boot-up state
LED is Red	Radio is in a fault state

7.2 Wireless Network Links

The wireless network link uses a series of LEDs to indicate status, as identified by the removable faceplate.

Only the yellow bank of LEDs is currently utilized. The green bank of LEDs is not functional.

LED Identifier	STA / AP	Description
MODE	All	Off = wireless not configured Flashing, 50% duty cycle; 1 sec interval = Client ½ sec interval = Access Point
ASSOC	STA only	Wireless association state. ON when STA is associated
TxRx	All	Wireless Tx/Rx activity.
SEC	n/a	Not currently implemented

Business Entity Identifier	Business Identifier	DTC	Revision
9950-15900	3CU 04036 0026 PCZZA	108	0A

8. MAINTENANCE

Mounting the radio should include consideration for the maintenance strategy in terms of ease of complexity and time of radio replacement.

There are no serviceable parts within the radio. This applies to both the Standalone and Die-cast units.

The Die-cast unit has an input fuse which is externally accessible and next to the input power connector. Refer to Power Interface section for details.



WARNING

Do not allow foreign objects to be inserted in any connector or openings as damage may occur.

Business Entity Identifier	Business Identifier	DTC	Revision
9950-15900	3CU 04036 0026 PCZZA	108	0A

CONFIDENTIAL © Thales Canada, Transportation Solutions. All rights reserved. Passing on or copying of this document, use or communication of its content in whole or in part is not permitted without prior written authorization.

9. SAFETY

Warning!

LED or Laser components according to IEC 60825-1 (2001):

CLASS 1 LASER PRODUCT.

LIGHT EMITTING DIODE – CLASS 1 LED PRODUCT.

WARNING – FIBER OPTIC INTERFACES



LED LIGHT

DO NOT STARE INTO THE BEAM OR VIEW DIRECTLY WITH OPTICAL INSTRUMENTS (e.g. lens, microscope).

For Die-cast unit only:

WARNING



Proper precaution **MUST** be exercised when touching and working on the equipment, as AC voltage may be present when working on the Die-cast unit.



The Die-cast unit contains high voltages on the input wiring / fusing and printed circuit board. Do not attempt to open the Die-cast unit for servicing.



Hot Surface. Surface may be Hot under elevated ambient temperature.

The Standalone unit has no hazardous voltages present.

Business Entity Identifier	Business Identifier	DTC	Revision
9950-15900	3CU 04036 0026 PCZZA	108	0A

CONFIDENTIAL © Thales Canada, Transportation Solutions. All rights reserved. Passing on or copying of this document, use or communication of its content in whole or in part is not permitted without prior written authorization.

10. INSTALLATION

The radio is not a consumer product, and therefore installation must be conducted by qualified personal, based on drawing approval by TCTS.

10.1 Standalone Unit

The standalone variant of the radio has two mounting methods; using the mounting feet, or securing directly to the bottom.

The mounting feet can accept a No. 10 (M5) screw.

Securing to the bottom side uses No. 10-32 screws. Maximum depth is 11/32" (8.5mm).

Refer to Figure 3 for mounting details. (Cable tie down bar is not exactly as shown).

It is recommended for the radio to be thermally connected to a metal base plate to aid in transferring heat to the environment.

It is recommended to tie down the cables leading to / from the unit, so that vibration is minimized / eliminated to the cables / connectors.

Business Entity Identifier	Business Identifier	DTC	Revision
9950-15900	3CU 04036 0026 PCZZA	108	0A

CONFIDENTIAL © Thales Canada, Transportation Solutions. All rights reserved. Passing on or copying of this document, use or communication of its content in whole or in part is not permitted without prior written authorization.

COMTRAC RADIO
USER MANUAL

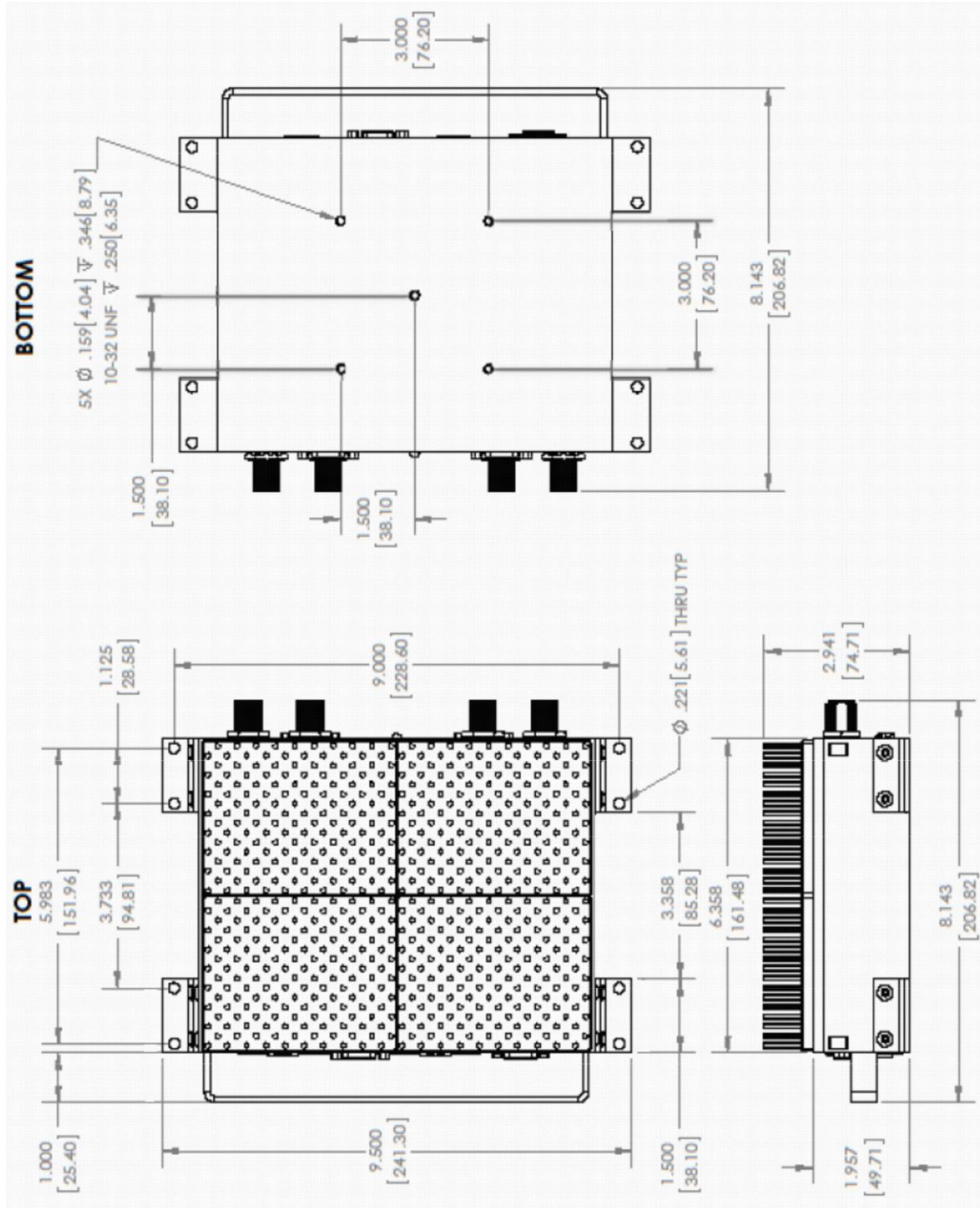

Figure 2 Mounting Dimensions

Business Entity Identifier	Business Identifier	DTC	Revision
9950-15900	3CU 04036 0026 PCZZA	108	0A

CONFIDENTIAL © Thales Canada, Transportation Solutions. All rights reserved. Passing on or copying of this document, use or communication of its content in whole or in part is not permitted without prior written authorization.

10.2 Die-cast Unit

The die-cast variant of the radio is designed for an outdoor environment, and has IP66 / NEMA 4X ratings. It also has a solar shield option. Contact TCTS for further details.

The mounting holes accommodate No. 12 (M6) size screw.

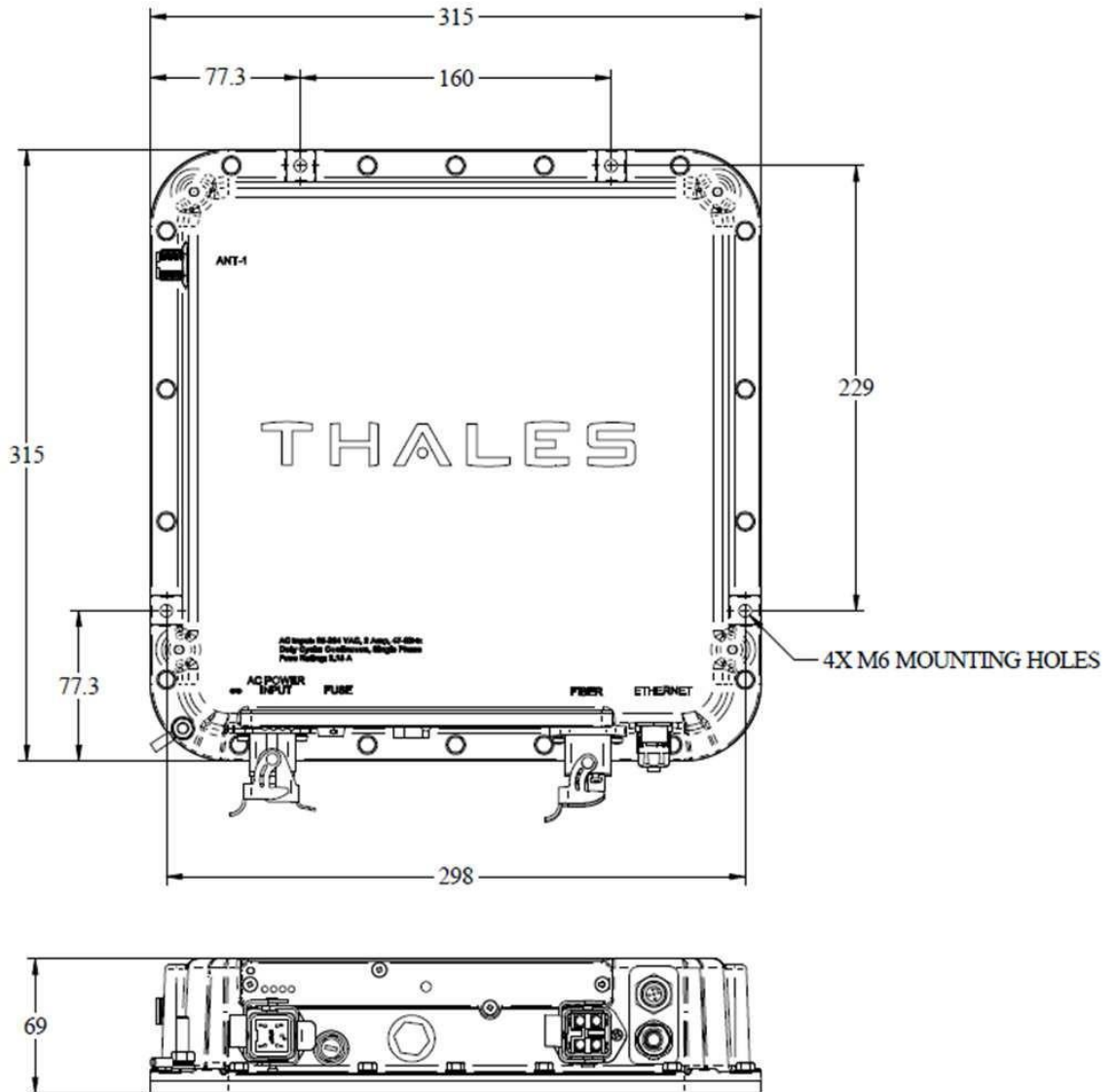

Figure 3 Mounting Dimensions – Die-cast Unit

Business Entity Identifier	Business Identifier	DTC	Revision
9950-15900	3CU 04036 0026 PCZZA	108	0A

CONFIDENTIAL © Thales Canada, Transportation Solutions. All rights reserved. Passing on or copying of this document, use or communication of its content in whole or in part is not permitted without prior written authorization.

11. EMC CONSIDERATIONS

To ensure the radio is compliant with EMC emission standards, the radio must be connected to ground. It is recommended to use a braided cable kept as short as practical for this purpose. Maximum length between bonding points should be less than 1 meter.

For the Standalone variant, this connection is located on the side of the unit, using the screw location with the open area around / underneath the screw head. It is identified by a ground symbol. The mounting screw is a No. 8 (4mm) and comes with the unit. Locking hardware is needed.

For the Die-cast variant, this connection is located at the corner near the power connector, and is identified by a ground symbol.

The size of the grounding bolt is a No. 6 (3.5mm) and comes with locking hardware and an N10, #16-14, crimp terminal ring.

This connection is also necessary to comply with safety standards.

Business Entity Identifier	Business Identifier	DTC	Revision
9950-15900	3CU 04036 0026 PCZZA	108	0A

12. DEPLOYMENT CONSIDERATIONS

In the context of CBTC deployment, careful considerations for bandwidth usage must be taken into account for traffic passing over the wireless interface. Quality of Service (QoS) is a mechanism to help prioritize CBTC traffic versus diagnostic and other types of traffic, is implemented and configurable. Refer to the QoS section in [1] for further details.

EIRP limits pertaining to the region where installed must not be exceeded. The use of a spreadsheet is recommended to ensure compliance to this limit, as well to ensure the RF link is balanced. Recommend to calculate the WRU's power setting first, as this is typically what limits the power level setting for the system. See details in the following section for calculating the RF transmit power setting.

Consecutive WRUs should have a different hop sequence in order to reduce co-channel interference. Refer to notes in the Wireless Parameter section in [1] for details.

The ComTrac Radio contains a network identifier, and is the same for all radios deployed in the region. Both the client and access points are to have the same ESSID. Refer to the Wireless Parameter section in [1] for configuration.

The same also applies to the wireless security type and key parameters.

Business Entity Identifier	Business Identifier	DTC	Revision
9950-15900	3CU 04036 0026 PCZZA	108	0A

12.1 Wayside Radio Unit

The WRU is positioned along the guideway. Spacing and placement is determined by an RF survey to ensure continuous overlapping RF coverage.

The ComTrac radio standalone variant can be housed in an outdoor rated enclosure, along with an AC/DC power supply and bandpass filter.

Alternatively, the die-cast variant can be deployed on its own. It contains the AC/DC power supply and bandpass filter.

Typical antenna is the Andrew Flat Planar Array Microceptor, QD-2402, with 16 dBi.

Typical two antenna system is show below.

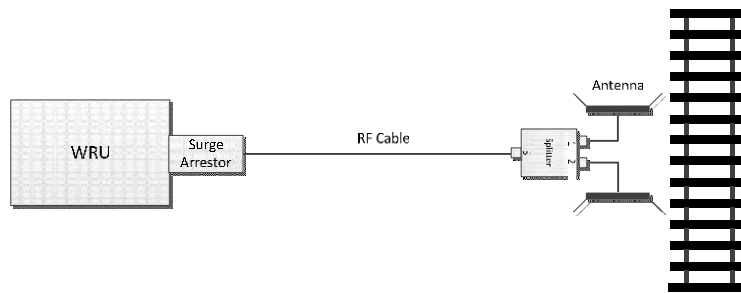

Figure 4 Access Point Radio Installation – Two Antennas

Typical four antenna system, servicing different tracks (areas), is show below.

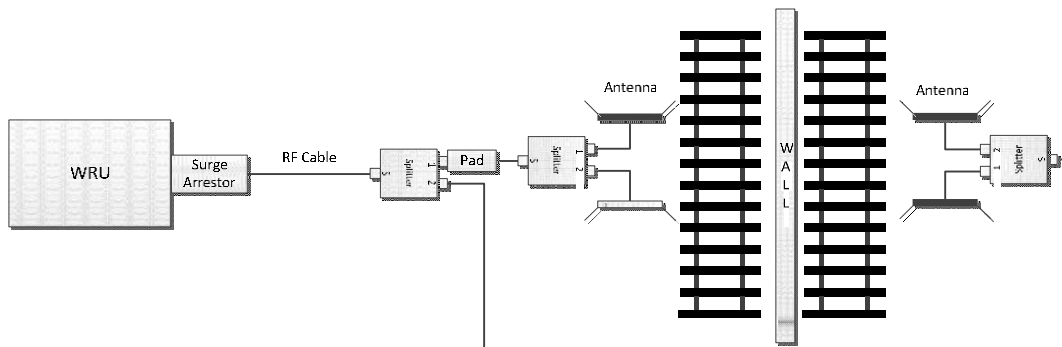

Figure 5 Access Point Radio Installation – Four Antennas

Business Entity Identifier	Business Identifier	DTC	Revision
9950-15900	3CU 04036 0026 PCZZA	108	0A

CONFIDENTIAL © Thales Canada, Transportation Solutions. All rights reserved. Passing on or copying of this document, use or communication of its content in whole or in part is not permitted without prior written authorization.

12.1.1 Access Point Power Setting

When installing the WRU radio, the power level must be set in order to not exceed the maximum output power and/or EIRP requirements for the region of deployment, which is measured at the antenna output.

In the four antenna system, the antennas closer to the WRU will have a slightly higher output signal level if there is less cabling (less link loss). The use of an attenuator (or pad) should be used to balance the antenna system. The value of the pad is determined by the difference in the link budget (link loss) between the two antenna systems.

For FCC compliance of Point-to-Multipoint Communication;

- The maximum output power from the intentional radiator (radio) is +30 dBm (1 watt), delivered to an antenna with a maximum gain of 6dBi. This equates to a maximum EIRP of +36dBm (4 watts).

- If using directional antenna with a gain greater than 6 dBi, then the conducted output power from the radio is reduced by the additional gain above 6 dBi.

Example: If using a directional antenna with a gain of 16 dBi, then the maximum power applied to the antenna port will be $+36 - 16 = +20$ dBm. [or; $(6-16) +30$ dBm = +20dBm].

The transmitters (radio) output power can be calculated by factoring the additional loss, and increasing this value to a maximum of +30 dBm.

Example: Using the 16 dBi gain antenna example above, and considering the losses for one 2-way splitter of 3.5 dB (power + insertion loss), a surge suppressor of 0.5 dB (insertion + coupling loss), and total cabling of 2 dB (cable losses), then the transmitter output power level is $+20 +3.5 +0.5 + 2 = +26$ dBm.

Business Entity Identifier	Business Identifier	DTC	Revision
9950-15900	3CU 04036 0026 PCZZA	108	0A

12.2 Mobile Radio Unit

The MRU, or client radio, is situated on a train, and is connected to one of the two independent vehicle on-board computer replicas. There will be one MRU at each end of the train. The antennas for each MRU are connected at one end of the train only, and setup with diversity. Each radio is powered by an independent direct current (DC) power supply.

The link budget for each antenna connection must be the same to ensure antenna diversity is optimized. This means the antenna cable type and length must be the same.

The distance between the two antennas is recommended to be greater than 5 wavelengths apart. One wavelength (λ) is about 12 cm.

Typical antenna is the Huber+Suhner Linear polarized antenna, 1324.17.0098, 8.5 dBi or 1324.99.0025, 8.5 dBi.

Typical on-board installation is shown below.

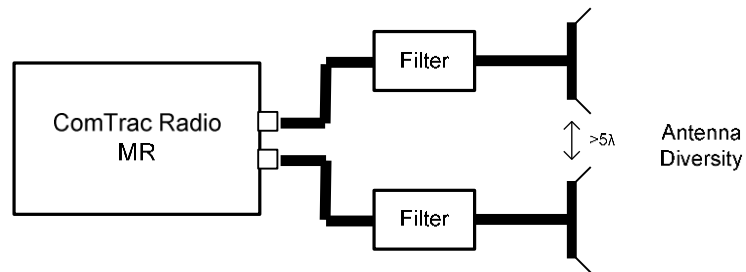

Figure 6 Mobile Radio Installation

12.2.1 Mobile Power Setting

When installing the mobile radio, the power level must be set in order to not exceed the maximum output power and/or EIRP requirements for the region of deployment, which is measured at the antenna output. In the configuration above, only one antenna will be transmitting at any given time.

For mobile radio power level setting, the output power level should be the same as what is set for the WRU, in order to produce a balanced RF link (same power level seen by

Business Entity Identifier	Business Identifier	DTC	Revision
9950-15900	3CU 04036 0026 PCZZA	108	0A

CONFIDENTIAL © Thales Canada, Transportation Solutions. All rights reserved. Passing on or copying of this document, use or communication of its content in whole or in part is not permitted without prior written authorization.

the both receivers).

For FCC compliance of Point-to-Multipoint Communication;

- The maximum output power from the intentional radiator (radio) is +30 dBm (1 watt), delivered to an antenna with a maximum gain of 6dBi. This equates to a maximum EIRP of +36dBm (4 watts).

- If using directional antenna(s) with a gain greater than 6 dBi, then the conducted output power from the radio is reduced by the additional gain above 6 dBi.

Example: If using a directional antenna with a gain of 8.5 dBi, then the maximum power applied to the antenna port will be $+36 - 8.5 = +27.5$ dBm.

The radio output power can be calculated by factoring the additional loss, and increasing this value to a maximum of +30 dBm.

Example: Using the 8.5 dBi gain antenna example above, and considering the losses for one bandpass filter of 2 dB (power + insertion loss), and total cabling of 2 dB (cable losses), then the transmitter output power level is $+27.5 + 2 + 2 = +31.5$ dBm max.

However, in this case where the mobile radios power level can be set higher than the WRU, use the WRUs power level setting for the mobile to ensure a balanced RF link.

12.2.2 Antenna Diversity

Antenna diversity is used on the MRU installation and configuration only. The testing of the installation must take this into consideration when measuring RF signals, as the active transmit antenna port may change.

Refer to [1] for further details.

Business Entity Identifier	Business Identifier	DTC	Revision
9950-15900	3CU 04036 0026 PCZZA	108	0A

13. REGULATORY COMPLIANCE NOTES

Electronic Emission Notices

This device complies with Part 15 of the FCC rules, ETSI 300-328, and CE.

Operation of these devices is subject to the following conditions:

1. This device may not cause harmful interference.
2. This device must accept any interference received, including interference that may cause undesired operation.

This device complies with Industry Canada licence-exempt RSS standard(s). Operation is subject to the following two conditions:

1. This device may not cause harmful interference, and
2. This device must accept any interference, including interference that may cause undesired operation of the device.

Le présent appareil est conforme aux CNR d'industrie Canada applicables aux appareils radio exempts de licence. L'exploitation est autorisée aux deux conditions suivantes:

1. L'appareil ne doit pas produire de brouillage, et
2. L'utilisateur de l'appareil doit accepter tout brouillage radioélectrique subi, même si le brouillage est susceptible d'en compromettre le fonctionnement.

This Class A digital apparatus complies with Canadian ICES-003.

Cet appareil numérique de la classe A est conforme a la norme NMB-003 du Canada.

Business Entity Identifier	Business Identifier	DTC	Revision
9950-15900	3CU 04036 0026 PCZZA	108	0A

CONFIDENTIAL © Thales Canada, Transportation Solutions. All rights reserved. Passing on or copying of this document, use or communication of its content in whole or in part is not permitted without prior written authorization.

COMTRAC RADIO USER MANUAL

FCC Radio Frequency Interference Statement

This equipment has been tested and found to comply within the limits for a Class DSS digital device, pursuant to Part 15 of the FCC rules. These limits are designed to provide reasonable protection against harmful interference when the equipment is operated in a commercial environment. This equipment generates, uses, and can radiate radio frequency energy and, if not installed and used in accordance with the instruction manual, may cause harmful interference to radio communications. Operation of this equipment in a residential area is likely to cause harmful interference in which cases the user will be required to correct the interference at his/her own expense.

FCC Information Statements

Changes or modifications not expressly approved by Thales could void the user's authority to operate the equipment.

Note: This equipment has been tested and found to comply with the limits for a Class A digital device, pursuant to part 15 of the FCC Rules. These limits are designed to provide reasonable protection against harmful interference when the equipment is operated in a commercial environment. This equipment generates, uses, and can radiate radio frequency energy and if not installed and used in accordance with the instruction manual, may cause harmful interference to radio communications. Operation of this equipment in a residential area is likely to cause harmful interference in which case the user will be required to correct the interference at his own expense.

The intended use of the ComTrac Radio is not for the general public. It is for industry/commercial use in Thales Communication Based Train Control (CBTC) systems and cannot be sold retail, to the general public or by mail order.

The ComTrac Radio requires professional installation, as the installed unit requires special programming (configuration is based on site specific parameters) during system deployment and access must be limited (secure) due to safety requirements.

Business Entity Identifier	Business Identifier	DTC	Revision
9950-15900	3CU 04036 0026 PCZZA	108	0A

CONFIDENTIAL © Thales Canada, Transportation Solutions. All rights reserved. Passing on or copying of this document, use or communication of its content in whole or in part is not permitted without prior written authorization.

Template : 83410477-DOC-CAN-EN

COMTRAC RADIO
USER MANUAL

FCC and IC RF Exposure Warning Statement

The antennas used for this transmitter must be installed to provide a separation distance of at least 20 cm from all persons and not be co-located with any other antenna or transmitters except as described in this manual.

Les antennes utilisées pour cet émetteur doit être installée pour fournir une distance de séparation d'au moins 20 cm de toute personne et ne pas être co-localisées avec une autre antenne ou émetteur sauf tel que décrit dans ce manuel.

Business Entity Identifier	Business Identifier	DTC	Revision
9950-15900	3CU 04036 0026 PCZZA	108	0A

CONFIDENTIAL © Thales Canada, Transportation Solutions. All rights reserved. Passing on or copying of this document, use or communication of its content in whole or in part is not permitted without prior written authorization.

Template : 83410477-DOC-CAN-EN

**APPENDIX A
LABELLING INFORMATION**

STANDALONE VARIANT:



Model: 1964500-901
FCC ID: PXOCBTC-RADIO
IC : 7489B-CBTCRADIO **CE**

This device complies with Part 15 of the FCC Rules.
Operation is subject to the following two conditions:
(1) this device may not cause harmful interference, and
(2) this device must accept any interference received,
including interference that may cause undesired
operation.

THALES CBTC RADIO
P/N 3CU10385AAAA S/N XXXXXX ICS 03

Business Entity Identifier	Business Identifier	DTC	Revision
9950-15900	3CU 04036 0026 PCZZA	108	0A

CONFIDENTIAL © Thales Canada, Transportation Solutions. All rights reserved. Passing on or copying of this document, use or communication of its content in whole or in part is not permitted without prior written authorization.

COMTRAC RADIO
USER MANUAL

DIE-CAST VARIANT:

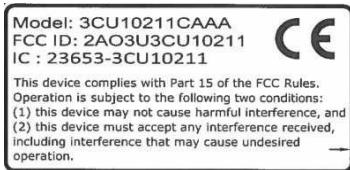

END OF DOCUMENT

Business Entity Identifier	Business Identifier	DTC	Revision
9950-15900	3CU 04036 0026 PCZZA	108	0A

CONFIDENTIAL © Thales Canada, Transportation Solutions. All rights reserved. Passing on or copying of this document, use or communication of its content in whole or in part is not permitted without prior written authorization.

COMTRAC RADIO
USER MANUAL
