

FCC Measurement/Technical Report on RF-560

FCC ID: 2A03N-TH39P6ERPI
IC: 23389-TH39P6ERPI

Test Report Reference: MDE_DEDRONE_2201_FCC_01

Test Laboratory:

7layers GmbH
Borsigstrasse 11
40880 Ratingen
Germany



Deutsche
Akkreditierungsstelle
D-PL-12140-01-01
D-PL-12140-01-02
D-PL-12140-01-03

Note:

The following test results relate only to the devices specified in this document. This report shall not be reproduced in parts without the written approval of the test laboratory.

7layers GmbH

Borsigstraße 11
40880 Ratingen, Germany
T +49 (0) 2102 749 0
F +49 (0) 2102 749 350

Geschäftsführer/
Managing Directors:
Sebastian Doose
Stefan Kischka
Bernhard Retka

Registergericht/registered:
Düsseldorf HRB 75554
USt-Id.-Nr./VAT-No. DE203159652
Steuer-Nr./TAX-No. 147/5869/0385

*a Bureau Veritas
Group Company*

www.7layers.com

Table of Contents

1 Applied Standards and Test Summary	3
1.1 Applied Standards	3
1.2 FCC-IC Correlation Table	4
1.3 Measurement Summary	4
2 Revision History / Signatures	6
3 Administrative Data	7
3.1 Testing Laboratory	7
3.2 Project Data	7
3.3 Applicant Data	7
3.4 Manufacturer Data	8
4 Test object Data	9
4.1 General EUT Description	9
4.2 EUT Main components	9
4.3 Ancillary Equipment	10
4.4 Auxiliary Equipment	10
4.5 EUT Setups	11
4.6 Operating Modes / Test Channels	11
4.7 Product labelling	11
5 Test Results	12
5.1 Conducted Emissions at AC mains	12
5.2 Radiated Emissions	15
6 Test Equipment	23
6.1 Test Equipment Hardware	23
6.2 Test Equipment Software	23
7 Antenna Factors, Cable Loss and Sample Calculations	28
7.1 LISN R&S ESH3-Z5 (150 kHz – 30 MHz)	28
7.2 Antenna R&S HFH2-Z2 (9 kHz – 30 MHz)	29
7.3 Antenna R&S HL562 (30 MHz – 1 GHz)	30
7.4 Antenna R&S HF907 (1 GHz – 18 GHz)	31
7.5 Antenna EMCO 3160-09 (18 GHz – 26.5 GHz)	32
7.6 Antenna EMCO 3160-10 (26.5 GHz – 40 GHz)	33
8 Measurement Uncertainties	34
9 Photo Report	35

1 APPLIED STANDARDS AND TEST SUMMARY

1.1 APPLIED STANDARDS

Applicable FCC Rules

Prepared in accordance with the requirements of FCC Rules and Regulations as listed in 47 CFR Ch.1 Parts 2 and 15 (10-1-21 Edition). The following subparts are applicable to the results in this test report.

Part 2, Subpart J - Equipment Authorization Procedures, Certification

Part 15, Subpart B – Unintentional Radiators

§ 15.107 Conducted limits

§ 15.109 Radiated emission limits; general requirements

§ 15.111 Antenna power conduction limits for receivers.

§ 15.121 Scanning receivers and frequency converters used with scanning receivers.

Applicable ISED Standards

ICES-Gen, Issue 1 + Amendment 1 (February 2021)

ICES-003, Issue 7

Note:

ANSI C63.4-2014 is applied.

1.2 FCC-IC CORRELATION TABLE

Correlation of measurement requirements for Information Technology Equipment (ITE) from FCC and ISED Canada

Measurement	FCC reference	ISED reference
Conducted Emissions (AC Power Line)	§15.107	ICES-003 Issue 7: 3.3.1
Radiated Spurious Emissions	§15.109	ICES-003 Issue 7: 3.3.2
Antenna Power conduction limits for receivers	§ 15.111	RSS-135 Issue 2 RSS-GEN Issue 5: 7.4
Scanning receivers and frequency converters used with scanning receivers	§ 15.121	-

Remarks:

1. FCC Part 15 subpart B, ICES 003 and CISPR 22 contain different definitions of Class A and Class B limits, i.e. which class is applicable to which kind of EUT.
ICES 003 and CISPR 22 distinguish between the location where the EUT is intended to operate whilst FCC refers to the method of commercial distribution (distributive trades).
2. The correct assignment of the appropriate class to the concrete EUT is not scope of this test report!
3. A radio apparatus that is specifically subject to an ISED Radio Standard Specification (RSS) and which contains an ITE is not subject to ICES-003 provided the ITE is used only to enable operation of the radio apparatus and the ITE does not control additional functions or capabilities.
4. ISM (Industrial, Scientific or Medical) radio frequency generators, though they may contain ITE, are excluded from the definition of ITE and are not subject to ICES-003. They are instead subject to the Interference-Causing Equipment Standard ICES-001, which specifically addresses ISM radio frequency generators.

1.3 MEASUREMENT SUMMARY

47 CFR CHAPTER I FCC PART 15 Subpart B

§ 15.107 Class A

Conducted Emissions at AC mains

The measurement was performed according to ANSI C63.4

Final Result

OP-Mode	Setup	Date	FCC	IC
AC mains connection, Test setup via auxiliary equipment, computer peripheric	S01_aa02	2023-04-25	Passed	Passed

47 CFR CHAPTER I FCC PART 15 Subpart B

§ 15.109 Class B

Radiated Emissions

The measurement was performed according to ANSI C63.4

Final Result

OP-Mode	Setup	Date	FCC	IC
AC mains connection, Measurement range, Test setup via auxiliary equipment, 26 GHz - 40 GHz, computer peripheric	S01_aa02	2023-04-27	Passed	Passed
via auxiliary equipment, 18 GHz - 26 GHz, computer peripheric	S01_aa02	2023-04-27	Passed	Passed
via auxiliary equipment, 1 GHz - 18 GHz, computer peripheric	S01_aa02	2023-04-24	Passed	Passed
via auxiliary equipment, 30 MHz - 1 GHz, computer peripheric	S01_aa02	2023-04-24	Passed	Passed

N/A: Not applicable

N/P: Not performed

2 REVISION HISTORY / SIGNATURES

Report version control			
Version	Release date	Change Description	Version validity
initial	2023-06-01	--	valid
--	--	--	--

COMMENT: -



(responsible for accreditation scope)
Marco Kulik



(responsible for testing and report)
Mohamed Fraïtat



7 layers GmbH, Borsigstr. 11
40880 Ratingen, Germany
Phone +49 (0)2102 749 0

3 ADMINISTRATIVE DATA

3.1 TESTING LABORATORY

Company Name: 7layers GmbH
Address: Borsigstr. 11
40880 Ratingen
Germany

The test facility is accredited by the following accreditation organisation:

Laboratory accreditation no: DAKKS D-PL-12140-01-01 | -02 | -03
FCC Designation Number: DE0015
FCC Test Firm Registration: 929146
ISED CAB Identifier DE0007; ISED#: 3699A

Responsible for accreditation scope: Marco Kulik
Report Template Version: 2022-05-25

3.2 PROJECT DATA

Responsible for testing and report: Mohamed Fraitat
Employees who performed the tests: documented internally at 7Layers
Date of Report: 2023-06-01
Testing Period: 2023-04-24 to 2023-04-27

3.3 APPLICANT DATA

Company Name: Dedrone Holdings, Inc
Address: 45662 Terminal Dr, Suite 110, Sterling,
VA 20166
USA
Contact Person: Mr. Robin H. Jaeger

3.5 MANUFACTURER DATA

Company Name: Dedrone GmbH

Address: Miramstraße 87
34128 Kassel
Germany

Contact Person: Mr. Robin H. Jaeger

4 TEST OBJECT DATA

4.1 GENERAL EUT DESCRIPTION

Kind of Device product description	The RF Sensor RF-560 is a sensor component for DEDRONE's Drone detection system. It integrates three kinds of frequency scanner to detect and locate Unmanned Autonomous Vehicles (UAV) on the property of the customer. It scans the RF spectrum passively for known patterns and alarms the customer on detection.
Product name	RF-560
Type	RF-560
Declared EUT data by the supplier	
Power Supply Type	AC
Nominal Voltage / Frequency	110/240VAC 60Hz
Test Voltage / Frequency	110VAC / 60 Hz
Highest internal frequency	1910 MHz (cellular) 5800 MHz (wlan receiving only)
Ports	<ul style="list-style-type: none"> - Power (connected to AC/DC converter, 1m) - Ethernet (connected to Router, 1m) - Antenna <ul style="list-style-type: none"> o Ch A (connected to antenna AUX 8, 0m) o Ch B (connected to antenna AUX 9, 0m) o A1 (connected to antenna AUX 7, 0m) o A2 (connected to antenna AUX 6, 0m)

4.2 EUT MAIN COMPONENTS

Sample Name	Sample Code	Description
EUT AA02	DE1270009aa02	radiated sample
Sample Parameter	Value	
Serial No.	DR0560DEVSP5001023	
HW Version	1	
SW Version	5	
Comment		

NOTE: The short description is used to simplify the identification of the EUT in this test report.

4.4 ANCILLARY EQUIPMENT

For the purposes of this test report, ancillary equipment is defined as equipment which is used in conjunction with the EUT to provide operational and control features to the EUT. It is necessary to configure the system in a typical fashion, as a customer would normally use it. But nevertheless Ancillary Equipment can influence the test results.

Device	Details (Manufacturer, Type Model, OUT Code)	Description
-	-	-

4.5 AUXILIARY EQUIPMENT

For the purposes of this test report, auxiliary equipment is defined as equipment which is used temporarily to enable operational and control features especially used for the tests of the EUT which is not used during normal operation or equipment that is used during the tests in combination with the EUT but is not subject of this test report. It is necessary to configure the system in a typical fashion, as a customer would normally use it. But nevertheless Auxiliary Equipment can influence the test results.

Device	Details (Manufacturer, Type Model, HW, SW, S/N)	Description
AUX 1	Traco Power, TEX 120-112, -, 31852818570	AC/DC converter
AUX 2	Ettus Research, USRP E310, -, -, 3179372	Drone Simulator
AUX 3	-, Dronetag Beacon, -, -, 1596A34ADB93AF	Bluetooth simulator
AUX 4	Edimax Technology, BR-6478AC V2, -, -, 6478ACV261CB00089	WLAN Router (for WLAN simulation)
AUX 5	Linksys, WRT3200ACM, -, -, 1981160B900782	Router
AUX 6	-, OMB.433.B03F21, -, -, -	Antenna 433 MHz
AUX 7	-, OMB.868.B05F21, -, -, -	Antenna 868 MHz
AUX 8	L-com, HGV-2458-03U-NM, -, -, -	Antenna 2.4 and 5 G
AUX 9	-, AOA-2458-79AM, -, -, 21A25879M0007	Antenna 2.4 and 5 G
AUX 10	Fujitsu Ltd., AC Adapter 65W RE04:A13-065N3A, -, -, 184903C604	AC/DC Adapter RE04
AUX 11	Fujitsu Ltd., Laptop RE04:Lifebook U758, -, -, DSAL006396	Laptop

4.7 EUT SETUPS

This chapter describes the combination of EUTs and equipment used for testing. The rationale for selecting the EUTs, ancillary and auxiliary equipment and interconnecting cables, is to test a representative configuration meeting the requirements of the referenced standards.

Setup	Combination of EUTs	Description and Rationale
S01_aa02	EUT AA02, AUX1 to AUX11	Setup for Computer peripheric

4.8 OPERATING MODES / TEST CHANNELS

This chapter describes the operating modes of the EUTs used for testing.

- Drone detection
- Wifi detection
- Bluetooth detection
- PING via LAN to a laptop
- LTE eFDD2 Idle

4.9 PRODUCT LABELLING

4.9.1 FCC ID LABEL

Please refer to the documentation of the applicant.

4.9.2 LOCATION OF THE LABEL ON THE EUT

Please refer to the documentation of the applicant.

5 TEST RESULTS

5.1 CONDUCTED EMISSIONS AT AC MAINS

Standard **FCC Part 15 Subpart B**

The test was performed according to:
ANSI C63.4

5.1.1 TEST DESCRIPTION

The test set-up was made in accordance with the general provisions of ANSI C 63.4. The Equipment Under Test (EUT) was setup in a shielded room to perform the conducted emissions measurements in a typical installation configuration. The EUT was powered from 50 μ H || 50 Ohm Line Impedance Stabilization Network (LISN). The LISN's unused connections were terminated with 50 Ohm loads.

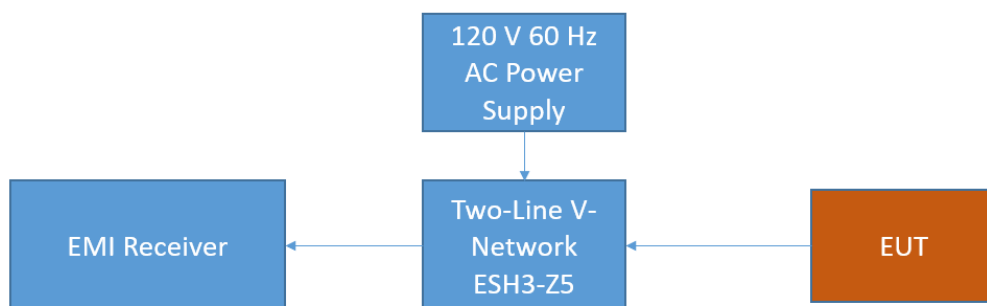

FCC Conducted Emissions on AC

The measurement procedure consists of two steps. It is implemented into the EMI test software EMC-32 from R&S.

Step 1: Preliminary scan

Intention of this step is, to determine the conducted EMI-profile of the EUT.

EMI receiver settings:

- Detector: Quasi-Peak & Average, trace Max-hold
- Frequency range: 150 kHz – 30 MHz
- Frequency steps: 2.5 kHz
- IF-Bandwidth: 9 kHz
- Measuring time / Frequency step: 100 ms (FFT-based)
- Measurement combinations:
 - 1) Neutral lead - reference ground (PE grounded)
 - 2) Phase lead - reference ground (PE grounded)
 - 3) Neutral lead - reference ground (PE floating)
 - 4) Phase lead - reference ground (PE floating)

On basis of this preliminary scan the highest amplitudes and the corresponding frequencies relative to the limit are identified. Emissions above the limit and emissions which are in the 10 dB range below the limit are considered.

Step 2: Final measurement

Intention of this step is, to determine the highest emissions with the settings defined in the test specification for the frequencies and leads identified in step 1.

EMI receiver settings:

- Detector: Quasi-Peak & CISPR-Average
- IF Bandwidth: 9 kHz
- Measuring time: 15 x 1 s / frequency

The highest value is reported in the table.

5.1.2 TEST REQUIREMENTS / LIMITS

FCC Part 15, Subpart B, §15.107

Class B:

Frequency (MHz)	QP Limits (dB μ V)	AV Limits (dB μ V)
0.15 - 0.5	66 - 56	56 - 46
0.5 - 5	56	46
5 - 30	60	50

Class A:

Frequency (MHz)	QP Limits (dB μ V)	AV Limits (dB μ V)
0.15 - 0.5	79	66
0.5 - 30	73	60

5.1.3 TEST PROTOCOL

Temperature: 24 °C
 Air Pressure: 1008 hPa
 Humidity: 37 %
 via auxiliary equipment, computer peripheral

PE	Power line	Frequency [MHz]	Level [dB μ V]	Detector	Limit [dB μ V]	Margin [dB]
FLO	L1	0,74	47,8	AV	60,0	12,2
FLO	L1	1,11	43,3	AV	60,0	16,7
FLO	L1	1,48	47,1	AV	60,0	12,9
FLO	L1	1,86	42,6	AV	60,0	17,4
FLO	L1	2,23	47,1	AV	60,0	13,0
FLO	L1	2,97	42,5	AV	60,0	17,5

Remark: Please see next sub-clause for the measurement plot.

5.1.5 MEASUREMENT PLOT (EXAMPLE PLOT, SHOWING WORST CASE, IF APPLICABLE)

Common Information

Test Description: Conducted Emissions / Class A
 Test Standard: FCC §15.107, ANSI C63.4
 EUT / Setup Code: DE1270009aa02 / S01_aa02
 Operating Conditions: 120 V 60 Hz, eFDD5D, LAN-Ping, drone detection on 433MHz, WLAN detection on Ch 1, BT detection
 Comment: AC mains via AUX 01, Computer peripheral Setup
 Legend: Trace: blue = QP, green = CISPR AV; Star: red or blue = critical frequency; Rhombus: blue = final QP, green = final CISPR AV
 Tested Port / used LISN: AC mains => 1st LISN ESH3-Z5
 Termination of other ports: AC of AUX => 2nd LISN ESH3-Z5 +50 Ohm

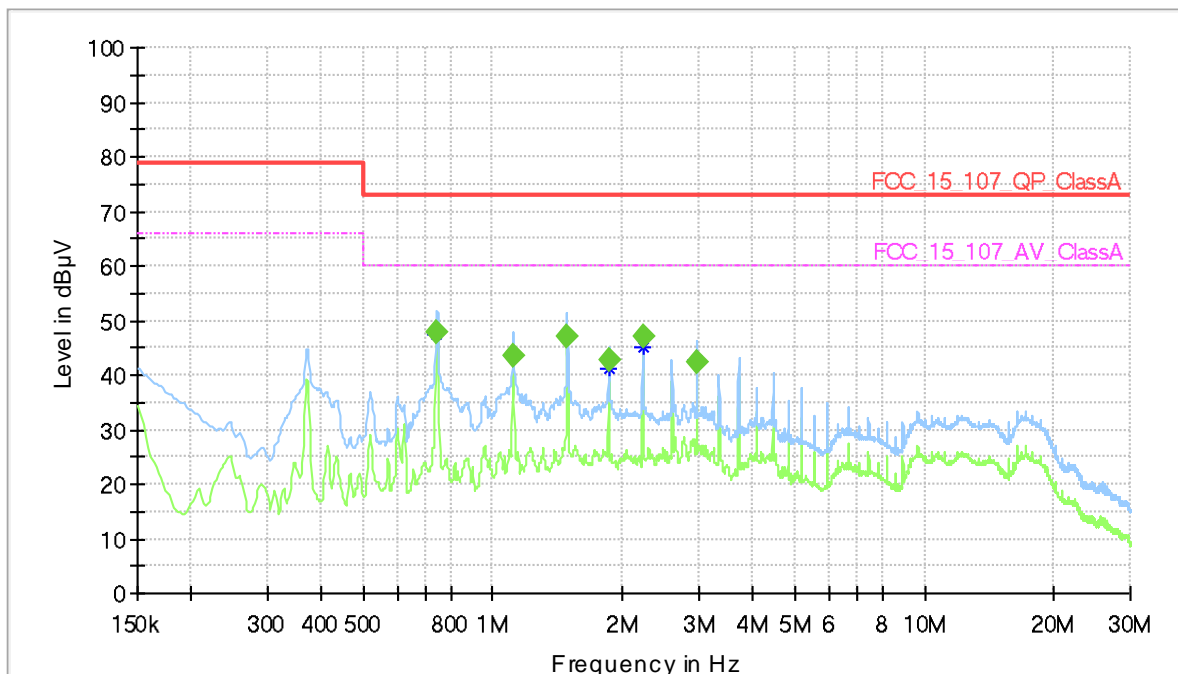

Final Result

Frequency (MHz)	QuasiPeak (dBµV)	CAverage (dBµV)	Limit (dBµV)	Margin (dB)	Meas. Time	Bandwidth (kHz)	Line	PE	Corr. (dB)
0.741750	---	47.82	60.00	12.18	1000.0	9.000	L1	FLO	10.1
1.113000	---	43.34	60.00	16.66	1000.0	9.000	L1	FLO	10.1
1.484250	---	47.09	60.00	12.91	1000.0	9.000	L1	FLO	10.2
1.855500	---	42.56	60.00	17.44	1000.0	9.000	L1	FLO	10.2
2.226750	---	47.05	60.00	12.95	1000.0	9.000	L1	FLO	10.2
2.969250	---	42.48	60.00	17.52	1000.0	9.000	L1	FLO	10.3

5.1.6 TEST EQUIPMENT USED

- Conducted Emissions FCC

5.2 RADIATED EMISSIONS

Standard **FCC Part 15 Subpart B**

The test was performed according to:
ANSI C63.4

5.2.1 TEST DESCRIPTION

The test set-up was made in accordance to the general provisions of ANSI C63.4 in a typical installation configuration. The measurements were performed according to the following sub-chapters of ANSI C63.4:

- 30 MHz – 1 GHz: Chapter 8.3.2.1
- > 1 GHz: Chapter 8.3.2.2

The measurement procedure is implemented into the EMI test software EMC32 from R&S. Exploratory tests are performed at 3 orthogonal axes to determine the worst-case orientation of a body-worn or handheld EUT. The final test on all kind of EUTs is also performed at 3 axes. A pre-check is performed while the EUT is powered.

The Equipment Under Test (EUT) was set up on a non-conductive table in the semi-anechoic chamber. The influence of the EUT support table that is used between 30–1000 MHz was evaluated.

1. Measurement setup

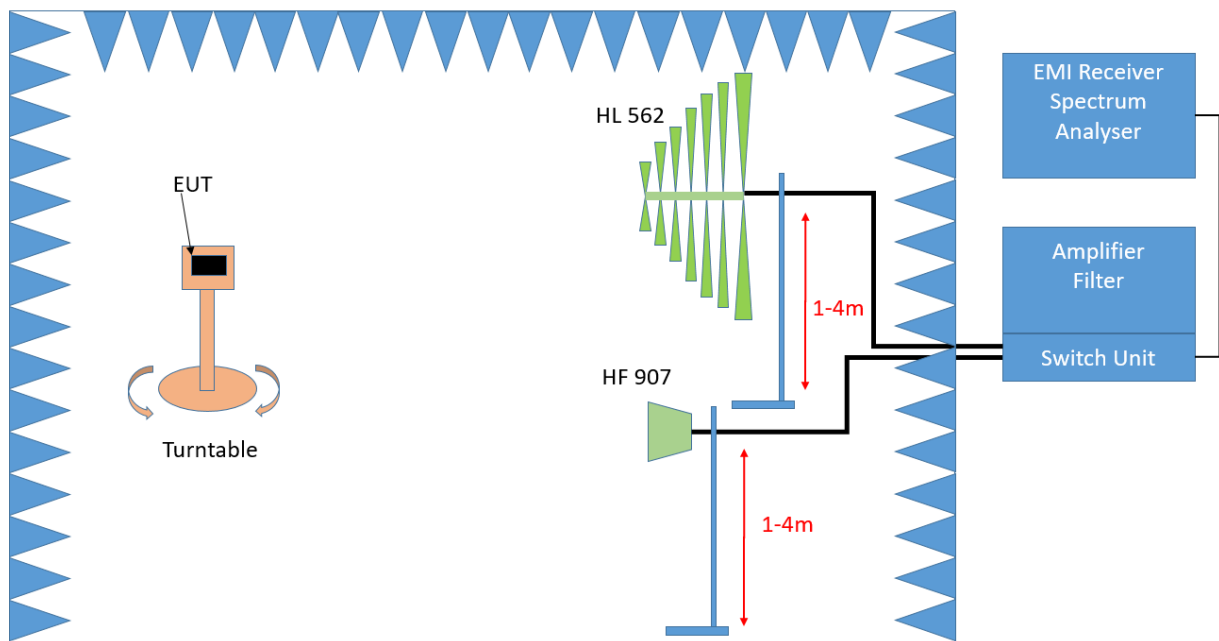

Test Setup; Spurious Emission Radiated (SAC)

Frequency range 30 MHz – 1 GHz

Step 1: Preliminary scan

This is a preliminary test to identify the highest amplitudes relative to the limit.

Settings for step 1:

- Antenna distance: 3 m
- Detector: Peak-Max-hold / Quasi-Peak (FFT-based)
- Frequency range: 30 – 1000 MHz
- Frequency steps: 30 kHz
- IF-Bandwidth: 120 kHz
- Measuring time / Frequency step: 100 ms
- Turntable angle range: -180° to 90°
- Turntable step size: 90°
- Height variation range: 1 – 4 m
- Height variation step size: 1.5 m
- Polarisation: Horizontal + Vertical

Intention of this step is, to determine the radiated EMI-profile of the EUT. Afterwards the relevant emissions for the final measurement are identified.

Step 2: Adjustment measurement

In this step the accuracy of the turntable azimuth and antenna height will be improved. This is necessary to find out the maximum value of every frequency.

For each frequency, which was determined the turntable azimuth and antenna height will be adjusted. The turntable azimuth will slowly vary by 360° . During this action, the value of emission is continuously measured. The turntable azimuth at the highest emission will be recorded and adjusted. In this position, the antenna height will slowly vary between 1 – 4 m. During this action, the value of emission is also continuously measured. The antenna height of the highest emission will also be recorded and adjusted.

- Detector: Peak – Max-hold
- Measured frequencies: in step 1 determined frequencies
- IF – Bandwidth: 120 kHz
- Measuring time: 100 ms
- Turntable angle range: 360°
- Height variation range: 1 – 4 m
- Antenna Polarization: max. value determined in step 1

Step 3: Final measurement with QP detector

With the settings determined in step 2, the final measurement will be performed:

EMI receiver settings for step 3:

- Detector: Quasi-Peak
- Measured frequencies: in step 1 determined frequencies
- IF – Bandwidth: 120 kHz
- Measuring time: 1 s

Above 1 GHz:

The following changes apply to the measurement procedure for the frequency range above 1 GHz:

Step 1:

- Turntable step size: 45°
- Detector: Peak, Average (Max-hold)
- IF – Bandwidth: 1 MHz
- Frequency steps: 250 kHz
- Measuring time: 500 ms / GHz

Step 2:

- IF – Bandwidth: 1 MHz

Step 3:

- Detector: Peak / CISPR Average
- IF – Bandwidth: 1 MHz

After every measurement a plot will be generated which contains a diagram with the results of the preliminary scan and a chart with the frequencies and values of the results of the final measurement.

5.2.2 TEST REQUIREMENTS / LIMITS

FCC Part 15, Subpart B, §15.109, Radiated Emission Limits

Class B:

Frequency (MHz)	Limit (µV/m)	Measurement distance (m)	Limits (dBµV/m)
30 – 88	100@3m	3	40.0@3m
88 – 216	150@3m	3	43.5@3m
216 – 960	200@3m	3	46.0@3m
960 - 26000	500@3m	3	54.0@3m
26000 - 40000	500@3m	1	54.0@3m

Class A:

Frequency (MHz)	Limit (µV/m)	Measurement distance (m)	Limits (dBµV/m)
30 – 88	90@10m	3	39.1@10m
88 – 216	150@10m	3	43.5@10m
216 – 960	210@10m	3	46.4@10m
960 - 26000	300@10m	3	49.5@10m
26000 - 40000	300@10m	1	49.5@10m

The measured values for Class A and for Class B (> 26 GHz) measurements are corrected with an inverse linear distance extrapolation factor (20 dB/decade).

§15.35(b) ..., there is also a limit on the radio frequency emissions, as measured using instrumentation with a peak detector function, corresponding to 20 dB above the maximum permitted average limit....

Used conversion factor: Limit (dBµV/m) = 20 log (Limit (µV/m)/1µV/m)

5.2.3 TEST PROTOCOL

Ambient temperature: 22 °C
 Air Pressure: 996 hPa
 Humidity: 36 %
 via auxiliary equipment, computer peripheric

Spurious Freq. [MHz]	Spurious Level [dB μ V/m]	Detector	RBW [kHz]	Limit [dB μ V/m]	Margin to Limit [dB]
32,1	35,9	QP	120	40,0	4,1
41,1	35,2	QP	120	40,0	4,8
84,1	33,6	QP	120	40,0	6,4
272,0	35,0	QP	120	46,0	11,0
800,7	24,1	QP	120	46,0	21,9
898,4	31,6	QP	120	46,0	14,4
1687,5	27,8	AV	1000	54,0	26,2
2388,8	54,6	PEAK	1000	74,0	19,4
5974,3	60,4	PEAK	1000	74,0	13,6
17835,3	59,9	PEAK	1000	74,0	14,1
17835,3	46,5	AV	1000	54,0	7,6

Remark: Please see next sub-clause for the measurement plot.

5.2.5 MEASUREMENT PLOT (EXAMPLE PLOT, SHOWING WORST CASE, IF APPLICABLE)

Diagram 2.01

Common Information

Test Description:	Radiated Emissions, Test Site: Semi Anechoic Chamber @ 4 m
Test Standard:	FCC §15.109, ANSI C63.4, Class B
Frequency range:	30 MHz – 1 GHz
EUT / Setup Code:	DE1270009aa02 / S01_aa02
Operating Conditions:	120 V 60 Hz, eFDD2 Idle, LAN-Ping, drone detection on 433MHz, WLAN detection on Ch 1, BT detection
Operator Name:	CAP
Comment:	AC mains via AUX 01, Computer peripheral Setup
Legend:	Trace (preview): blue = PK, green = QP; Star: red or blue = critical frequency; Rhombus: blue = final QP

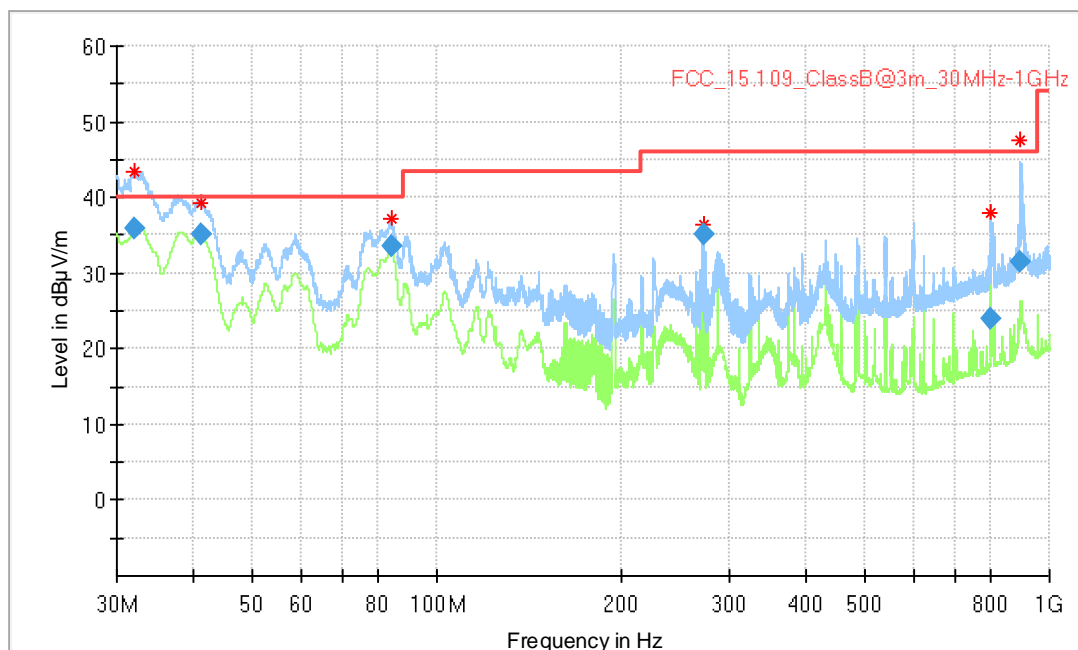

Final Result

Frequency (MHz)	QuasiPeak (dBµV/m)	Limit (dBµV/m)	Margin (dB)	Meas. Time (ms)	Bandwidth (kHz)	Height (cm)	Pol	Azimuth (deg)	Corr. (dB/m)
32.100000	35.91	40.00	4.09	1000.0	120.000	104.0	V	69.0	18.0
41.070000	35.19	40.00	4.81	1000.0	120.000	110.0	V	336.0	12.9
84.060000	33.57	40.00	6.43	1000.0	120.000	104.0	V	91.0	10.3
272.010000	35.02	46.00	10.98	1000.0	120.000	116.0	V	165.0	12.9
800.670000	24.07	46.00	21.93	1000.0	120.000	104.0	V	2.0	24.3
898.350000	31.58	46.00	14.42	1000.0	120.000	104.0	V	323.0	25.6

Diagram 2.02

Common Information

Test Description:	Radiated Emissions @ 3 m, SAC + mobile floor absorber
Test Standard:	FCC §15.109, ANSI C63.4
Frequency range:	1 GHz – 18 GHz
EUT / Setup Code:	DE1270009aa02
Operating Conditions:	120 V 60 Hz, eFDD2 Idle, LAN-Ping, drone detection on 433MHz, WLAN detection on Ch 1, BT detection
Operator Name:	CAP
Comment:	AC mains via AUX 01, Computer peripheral Setup
Legend:	Trace (preview): blue = PK, green = AV; Star: red or blue = critical frequency; Rhombus: blue = final Peak, green = Final CISPR AV

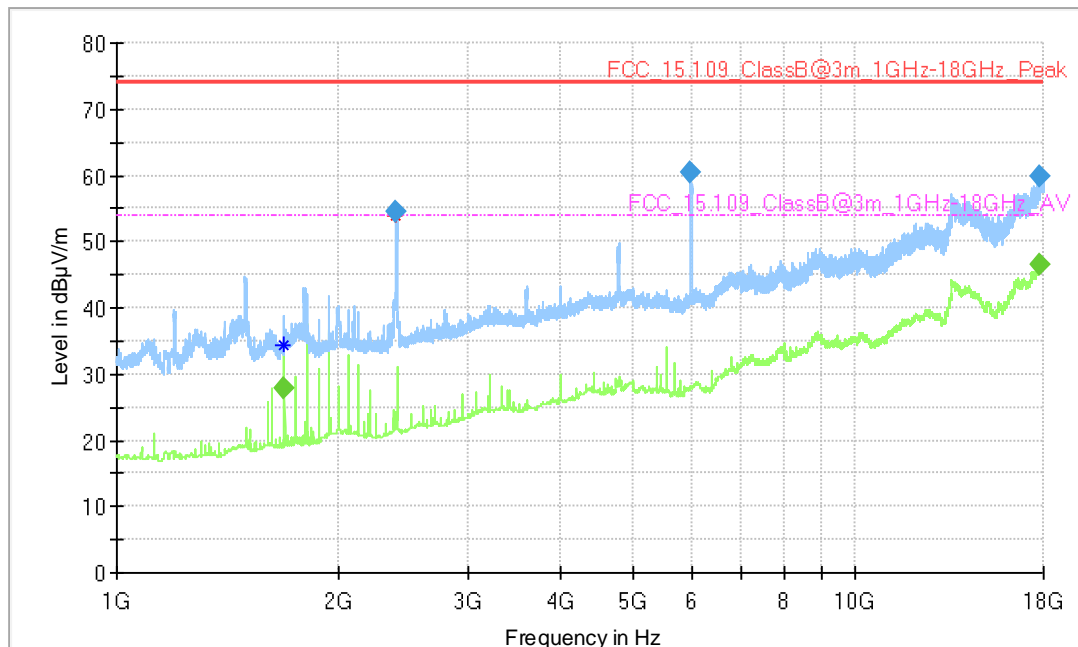

Final Result

Frequency (MHz)	MaxPeak (dBµV/m)	CAverage (dBµV/m)	Limit (dBµV/m)	Margin (dB)	Meas. Time (ms)	Bandwidth (kHz)	Height (cm)	Pol	Azimuth (deg)	Corr. (dB/m)
1687.500000	---	27.84	54.00	26.16	200.0	1000.000	342.0	V	88.0	2.8
2388.750000	54.63	---	74.00	19.37	200.0	1000.000	103.0	V	-95.0	6.0
5974.250000	60.36	---	74.00	13.64	200.0	1000.000	342.0	V	88.0	14.9
17835.250000	59.94	---	74.00	14.06	200.0	1000.000	365.0	V	-76.0	31.4
17835.250000	---	46.45	54.00	7.55	200.0	1000.000	365.0	V	88.0	31.4

Diagram 2.03

Common Information

Test Description:	Radiated Emissions in FAC
Test Standard:	FCC §15.109, ANSI C63.4
Frequency range:	18 GHz - 26 GHz
EUT / Setup Code:	DE1270009aa02 / S01_aa02
Operating Conditions:	120 V 60 Hz, eFDD2 Idle, LAN-Ping, drone detection on 433MHz, WLAN detection on Ch 1, BT detection
Comment:	AC mains via AUX 01, Computer peripheral Setup
Legend:	Trace (preview): blue = PK, green = AV; Star: red or blue = critical frequency; Rhombus: blue = final Peak, green = Final CISPR AV

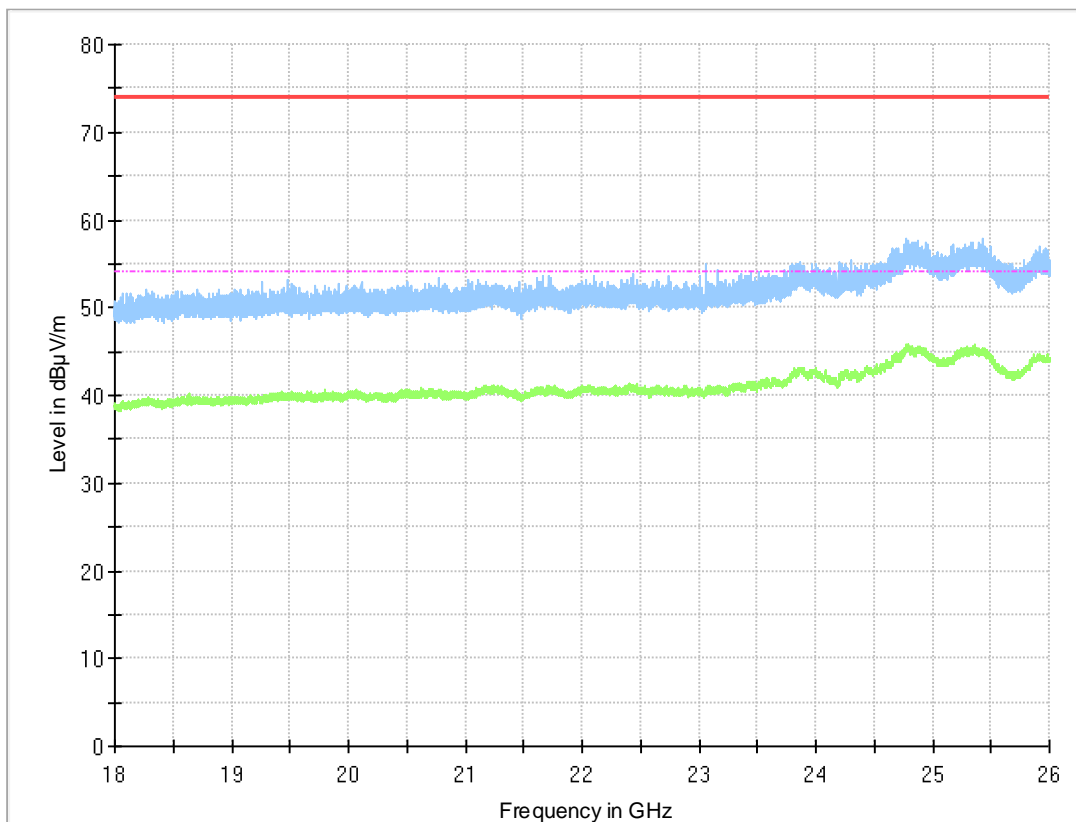
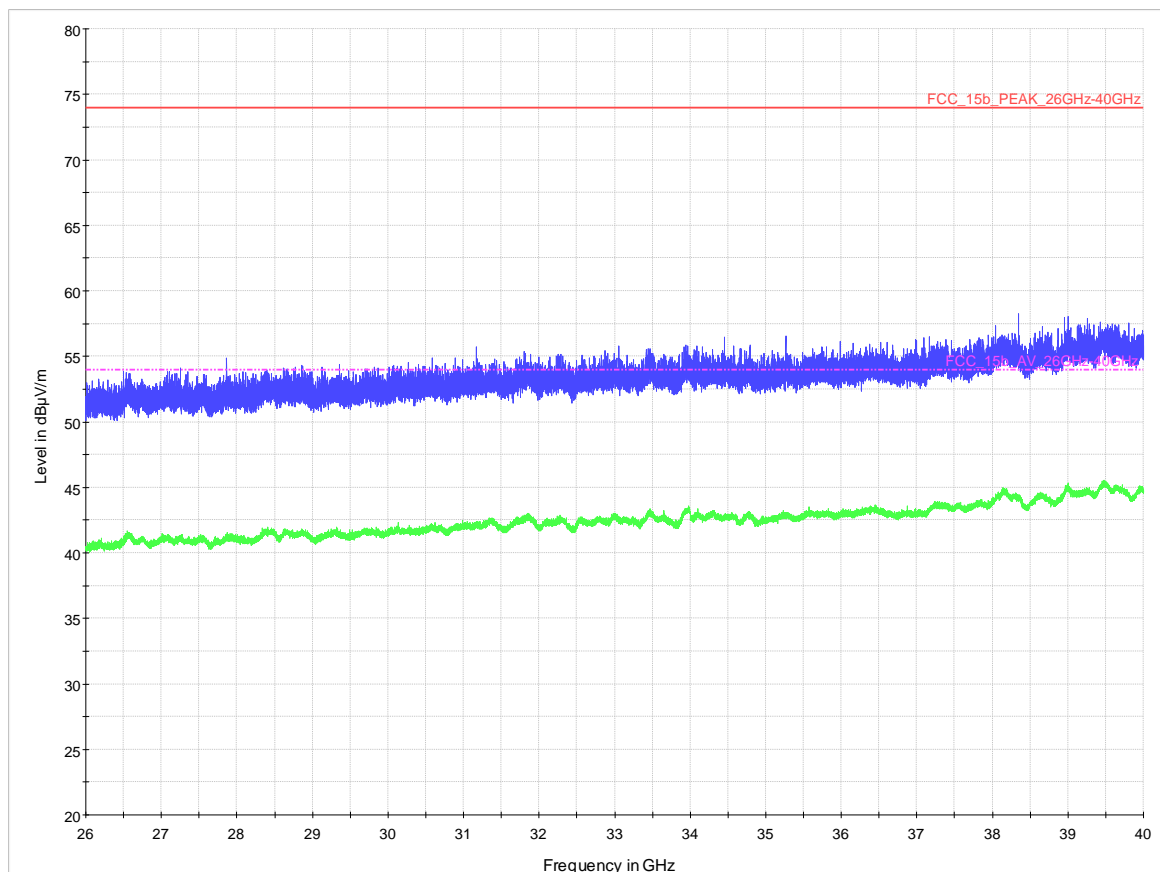

Diagram 2.04

Common Information

Test Description:	Radiated Emissions in FAC
Test Standard:	FCC §15.109
Frequency range:	26 GHz – 40 MHz
EUT / Setup Code:	DE1270009aa02 / S01_aa02
Operating Conditions:	120 V 60 Hz, eFDD2 Idle, LAN-Ping, drone detection on 433MHz, WLAN detection on Ch 1, BT detection
Comment	AC mains via AUX 01, Computer peripheral Setup
Legend:	Trace (preview): blue = PK, green = AV; Star: red or blue = critical frequency; Rhombus: blue = final Peak, green = Final CISPR AV



5.2.6 TEST EQUIPMENT USED

- Radiated Emissions SAC above 1 GHz
- Radiated Emissions SAC up to 1 GHz
- Radiated emissions FAC

6 TEST EQUIPMENT

6.1 TEST EQUIPMENT HARDWARE

- 1 Conducted Emissions FCC
Conducted Emissions AC Mains for FCC standards

Ref.No.	Device Name	Description	Manufacturer	Serial Number	Last Calibration	Calibration Due
1.1	Opus10 TPR (8253.00)	T/P Logger 13	Lufft Mess- und Regeltechnik GmbH	13936	2021-10	2023-10
1.2	SMBV100A	Vector Signal Generator 9 kHz - 3.2 GHz (GNSS / Broadcast Signalling Unit)	Rohde & Schwarz GmbH & Co. KG	260001	2021-02	2024-02
1.3	Fluke 177	Digital Multimeter 03 (Multimeter)	Fluke Europe B.V.	86670383	2022-06	2024-06
1.4	ESH3-Z5	Two-Line V-Network (AUX)	Rohde & Schwarz GmbH & Co. KG	828304/029	2021-08	2023-08
1.5	EP 1200/B, NA/B1	AC Source, Amplifier with integrated variable Oscillator	Spitzenberger & Spies GmbH & Co. KG	B6278	N/A	N/A
1.6	Chroma 6404	AC Source	Chroma ATE INC.	64040001304	N/A	N/A
1.7	CMW500	Callbox OIL-RE, SUW	Rohde & Schwarz GmbH & Co. KG	155999-Ei	2023-01	2026-01
1.8	CMW500	Callbox OIL-RE, SUA	Rohde & Schwarz GmbH & Co. KG	163529-bw	2023-01	2026-01
1.9	Shielded Room 02	Shielded Room 4m x 3m	Frankonia Germany EMC Solution GmbH	-		
1.10	CMW500	Callbox OIL-RE, SUA-160 MHz	Rohde & Schwarz GmbH & Co. KG	168927-cv	2020-05	2023-05
1.11	ESH3-Z5	Two-Line V-Network (EUT)	Rohde & Schwarz GmbH & Co. KG	829996/002	2021-08	2023-08
1.12	ESR 7	EMI Receiver / Spectrum Analyzer	Rohde & Schwarz	101424	2023-01	2025-01
1.13	CMW500	Callbox OIL-RE, SUA-160 MHz	Rohde & Schwarz GmbH & Co. KG	167766-By	2022-05	2025-05
1.14	Opus10 THI (8152.00)	T/H Logger 02	Lufft Mess- und Regeltechnik GmbH	7489	2021-10	2023-10
1.15	CS-RUB6	Rubidium Frequency Standard	Rohde & Schwarz GmbH & Co. KG	100321	2022-10	2023-10

2 Radiated Emissions SAC above 1 GHz
 Radiated emission tests above 1 GHz in a semi anechoic room with floor absorbers

Ref.No.	Device Name	Description	Manufacturer	Serial Number	Last Calibration	Calibration Due
2.1	N5000/NP	Filter for EUT, 2 Lines, 250 V, 16 A	ETS-LINDGREN	241515	N/A	N/A
2.2	Opus10 TPR (8253.00)	T/P Logger 13	Lufft Mess- und Regeltechnik GmbH	13936	2021-10	2023-10
2.3	ESW44	EMI Receiver / Spectrum Analyzer	Rohde & Schwarz GmbH & Co. KG	101603	2022-01	2024-01
2.4	Anechoic Chamber 01	SAC/FAR, 10.58 m x 6.38 m x 6.00 m	Frankonia	none	N/A	N/A
2.5	Fluke 177	Digital Multimeter 03 (Multimeter)	Fluke Europe B.V.	86670383	2022-06	2024-06
2.6	Opus10 THI (8152.00)	T/H Logger 10	Lufft Mess- und Regeltechnik GmbH	12488	2021-08	2023-08
2.7	EP 1200/B, NA/B1	AC Source, Amplifier with integrated variable Oscillator	Spitzenberger & Spies GmbH & Co. KG	B6278	N/A	N/A
2.8	DS 420S	Turn Table 2 m diameter	HD GmbH	420/573/99	N/A	N/A
2.9	JS4-00102600- 42-5A	Broadband Amplifier 30 MHz - 26 GHz	Miteq	619368	N/A	N/A
2.10	MA4985-XP-ET	Bore Sight Antenna Mast	innco systems GmbH	none	N/A	N/A
2.11	BB4312-C30- H3x	Filter Universal 1A	Siemens Matsushita Components	none	N/A	N/A
2.12	HF 907-2	Double-ridged horn	Rohde & Schwarz	102817	2022-07	2025-07

3 Radiated Emissions SAC up to 1 GHz
 Radiated emission tests up to 1 GHz in a semi anechoic room

Ref.No.	Device Name	Description	Manufacturer	Serial Number	Last Calibration	Calibration Due
3.1	N5000/NP	Filter for EUT, 2 Lines, 250 V, 16 A	ETS-LINDGREN	241515	N/A	N/A
3.2	Opus10 TPR (8253.00)	T/P Logger 13	Lufft Mess- und Regeltechnik GmbH	13936	2021-10	2023-10
3.3	ESW44	EMI Receiver / Spectrum Analyzer	Rohde & Schwarz GmbH & Co. KG	101603	2022-01	2024-01
3.4	Anechoic Chamber 01	SAC/FAR, 10.58 m x 6.38 m x 6.00 m	Frankonia	none	N/A	N/A
3.5	HL 562 ULTRALOG	Biconical-log- per antenna (30 MHz - 3 GHz) with HL 562E biconicals	Rohde & Schwarz GmbH & Co. KG	830547/003	2021-09	2024-09
3.6	Fluke 177	Digital Multimeter 03 (Multimeter)	Fluke Europe B.V.	86670383	2022-06	2024-06
3.7	Opus10 THI (8152.00)	T/H Logger 10	Lufft Mess- und Regeltechnik GmbH	12488	2021-08	2023-08
3.8	EP 1200/B, NA/B1	AC Source, Amplifier with integrated variable Oscillator	Spitzenberger & Spies GmbH & Co. KG	B6278	N/A	N/A
3.9	DS 420S	Turn Table 2 m diameter	HD GmbH	420/573/99	N/A	N/A
3.10	AM 4.0	Antenna Mast 4 m	Maturo GmbH	AM4.0/180/1192 0513	N/A	N/A

4 Radiated Emissions FAC

Ref. No.	Device Name	Description	Manufacturer	Serial Number	Last Calibration	Calibration Due
4.1	Opus10 TPR (8253.00)	T/P Logger 13	Lufft Mess- und Regeltechnik GmbH	13936	2021-10	2023-10
4.2	AMF- 7D00101800-30- 10P-R	Broadband Amplifier 100 MHz - 18 GHz	Miteq		N/A	N/A
4.3	5HC2700/12750- 1.5-KK	High Pass Filter	Trilithic	9942012	N/A	N/A
4.4	ASP 1.2/1.8-10 kg	Antenna Mast	Maturo GmbH	-	N/A	N/A
4.5	Anechoic Chamber 03	FAR, 8.80m x 4.60m x 4.05m (l x w x h)	Albatross Projects	P26971-647-001- PRB	N/A	N/A
4.6	Fluke 177	Digital Multimeter 03 (Multimeter)	Fluke Europe B.V.	86670383	2022-06	2024-06

4.7	JS4-18002600-32-5P	Broadband Amplifier 18 GHz - 26 GHz	Miteq	849785	N/A	N/A
4.8	FSW43	Spectrum Analyzer	Rohde & Schwarz GmbH & Co. KG	103779	2023-04	2025-04
4.9	3160-09	Standard Gain / Pyramidal Horn Antenna 26.5 GHz	EMCO Elektronik GmbH	00083069	N/A	N/A
4.10	WHKX 7.0/18G-8SS	High Pass Filter	Wainwright Instruments GmbH	09	N/A	N/A
4.11	4HC1600/12750-1.5-KK	High Pass Filter	Trilithic	9942011	N/A	N/A
4.12	TT 1.5 WI	Turn Table	Maturo GmbH	-	N/A	N/A
4.13	HL 562 ULTRALOG	Biconical-log-per Antenna (30 MHz - 3 GHz)	Rohde & Schwarz GmbH & Co. KG	100609	2022-06	2025-06
4.14	3160-10	Standard Gain / Pyramidal Horn Antenna 40 GHz	EMCO Elektronik GmbH	00086675	N/A	N/A
4.15	VLFX-650+	Low Pass Filter DC650 MHz	Mini-Circuits	15542	N/A	N/A
4.16	5HC3500/18000-1.2-KK	High Pass Filter	Trilithic	200035008	N/A	N/A
4.17	Opus 20 THI (8120.00)	ThermoHygro Datalogger	Lufft Mess- und Regeltechnik GmbH	115.0318.0802.033	N/A	N/A
4.18	TD1.5-10kg	EUT Tilt Device (Rohacell)	Maturo GmbH	TD1.5-10kg/024/3790709	N/A	N/A
4.19	PAS 2.5 - 10 kg	Antenna Mast	Maturo GmbH	-	N/A	N/A
4.20	AFS42-00101800-25-S-42	Broadband Amplifier 25 MHz - 18 GHz	Miteq	2035324	N/A	N/A
4.21	HF 907	Double-ridged horn	Rohde & Schwarz	102444	2021-09	2024-09

The calibration interval is the time interval between "Last Calibration" and "Calibration Due"

6.3 TEST EQUIPMENT SOFTWARE

Semi-Anechoic Chamber:	
Software	Version
EMC32 Measurement Software	10.60.10
INNCO Mast Controller	1.02.62
MATURO Mast Controller	12.19
MATURO Turn-Table Controller	30.10
Fully-Anechoic Chamber:	
Software	Version
EMC32 Measurement Software	10.60.10
MATURO Turn-Unit Cotroller	11.10
MATURO Mast Controller	12.10
MATURO Turntable Controller	12.11
Conducted AC Emissions:	
Software	Version
EMC32 Measurement Software	10.60.20

7 ANTENNA FACTORS, CABLE LOSS AND SAMPLE CALCULATIONS

This chapter contains the antenna factors with their corresponding path loss of the used measurement path for all antennas as well as the insertion loss of the LISN.

7.1 LISN R&S ESH3-Z5 (150 KHZ – 30 MHZ)

Frequency MHz	Corr. dB	LISN insertion loss ESH3- Z5 dB	cable loss (incl. 10 dB atten- uator) dB
0.15	10.1	0.1	10.0
5	10.3	0.1	10.2
7	10.5	0.2	10.3
10	10.5	0.2	10.3
12	10.7	0.3	10.4
14	10.7	0.3	10.4
16	10.8	0.4	10.4
18	10.9	0.4	10.5
20	10.9	0.4	10.5
22	11.1	0.5	10.6
24	11.1	0.5	10.6
26	11.2	0.5	10.7
28	11.2	0.5	10.7
30	11.3	0.5	10.8

Sample calculation

$$U_{\text{LISN}} (\text{dB } \mu\text{V}) = U (\text{dB } \mu\text{V}) + \text{Corr. (dB)}$$

U = Receiver reading

LISN Insertion loss = Voltage Division Factor of LISN

Corr. = sum of single correction factors of used LISN, cables, switch units (if used)

Linear interpolation will be used for frequencies in between the values in the table.

7.2 ANTENNA R&S HFH2-Z2 (9 KHZ – 30 MHZ)

Frequency MHz	AF HFH-Z2) dB (1/m)	Corr. dB	cable loss 1 (inside chamber) dB	cable loss 2 (outside chamber) dB	cable loss 3 (switch unit) dB	cable loss 4 (to receiver) dB	distance corr. (-40 dB/ decade) dB	d _{Limit} (meas. distance (limit) m	d _{used} (meas. distance (used) m
0.009	20.50	-79.6	0.1	0.1	0.1	0.1	-80	300	3
0.01	20.45	-79.6	0.1	0.1	0.1	0.1	-80	300	3
0.015	20.37	-79.6	0.1	0.1	0.1	0.1	-80	300	3
0.02	20.36	-79.6	0.1	0.1	0.1	0.1	-80	300	3
0.025	20.38	-79.6	0.1	0.1	0.1	0.1	-80	300	3
0.03	20.32	-79.6	0.1	0.1	0.1	0.1	-80	300	3
0.05	20.35	-79.6	0.1	0.1	0.1	0.1	-80	300	3
0.08	20.30	-79.6	0.1	0.1	0.1	0.1	-80	300	3
0.1	20.20	-79.6	0.1	0.1	0.1	0.1	-80	300	3
0.2	20.17	-79.6	0.1	0.1	0.1	0.1	-80	300	3
0.3	20.14	-79.6	0.1	0.1	0.1	0.1	-80	300	3
0.49	20.12	-79.6	0.1	0.1	0.1	0.1	-80	300	3
0.490001	20.12	-39.6	0.1	0.1	0.1	0.1	-40	30	3
0.5	20.11	-39.6	0.1	0.1	0.1	0.1	-40	30	3
0.8	20.10	-39.6	0.1	0.1	0.1	0.1	-40	30	3
1	20.09	-39.6	0.1	0.1	0.1	0.1	-40	30	3
2	20.08	-39.6	0.1	0.1	0.1	0.1	-40	30	3
3	20.06	-39.6	0.1	0.1	0.1	0.1	-40	30	3
4	20.05	-39.5	0.2	0.1	0.1	0.1	-40	30	3
5	20.05	-39.5	0.2	0.1	0.1	0.1	-40	30	3
6	20.02	-39.5	0.2	0.1	0.1	0.1	-40	30	3
8	19.95	-39.5	0.2	0.1	0.1	0.1	-40	30	3
10	19.83	-39.4	0.2	0.1	0.2	0.1	-40	30	3
12	19.71	-39.4	0.2	0.1	0.2	0.1	-40	30	3
14	19.54	-39.4	0.2	0.1	0.2	0.1	-40	30	3
16	19.53	-39.3	0.3	0.1	0.2	0.1	-40	30	3
18	19.50	-39.3	0.3	0.1	0.2	0.1	-40	30	3
20	19.57	-39.3	0.3	0.1	0.2	0.1	-40	30	3
22	19.61	-39.3	0.3	0.1	0.2	0.1	-40	30	3
24	19.61	-39.3	0.3	0.1	0.2	0.1	-40	30	3
26	19.54	-39.3	0.3	0.1	0.2	0.1	-40	30	3
28	19.46	-39.2	0.3	0.1	0.3	0.1	-40	30	3
30	19.73	-39.1	0.4	0.1	0.3	0.1	-40	30	3

Sample calculation

$$E \text{ (dB } \mu\text{V/m)} = U \text{ (dB } \mu\text{V)} + AF \text{ (dB 1/m)} + Corr. \text{ (dB)}$$

U = Receiver reading

AF = Antenna factor

Corr. = sum of single correction factors of used cables, switch unit, distance correction, amplifier (if applicable)

distance correction = $-40 * \text{LOG} (d_{\text{Limit}} / d_{\text{used}})$

Linear interpolation will be used for frequencies in between the values in the table.

Table shows an extract of values

7.3 ANTENNA R&S HL562 (30 MHZ – 1 GHZ)

($d_{Limit} = 3\text{ m}$)

Frequency	AF R&S HL562	Corr.
MHz	dB (1/m)	dB
30	18.6	0.6
50	6.0	0.9
100	9.7	1.2
150	7.9	1.6
200	7.6	1.9
250	9.5	2.1
300	11.0	2.3
350	12.4	2.6
400	13.6	2.9
450	14.7	3.1
500	15.6	3.2
550	16.3	3.5
600	17.2	3.5
650	18.1	3.6
700	18.5	3.6
750	19.1	4.1
800	19.6	4.1
850	20.1	4.4
900	20.8	4.7
950	21.1	4.8
1000	21.6	4.9

cable loss 1 (inside chamber)	cable loss 2 (outside chamber)	cable loss 3 (switch unit)	cable loss 4 (to receiver)	distance corr. (-20 dB/decade)	d_{Limit} (meas. distance (limit))	d_{used} (meas. distance (used))
dB	dB	dB	dB	dB	m	m
0.29	0.04	0.23	0.02	0.0	3	3
0.39	0.09	0.32	0.08	0.0	3	3
0.56	0.14	0.47	0.08	0.0	3	3
0.73	0.20	0.59	0.12	0.0	3	3
0.84	0.21	0.70	0.11	0.0	3	3
0.98	0.24	0.80	0.13	0.0	3	3
1.04	0.26	0.89	0.15	0.0	3	3
1.18	0.31	0.96	0.13	0.0	3	3
1.28	0.35	1.03	0.19	0.0	3	3
1.39	0.38	1.11	0.22	0.0	3	3
1.44	0.39	1.20	0.19	0.0	3	3
1.55	0.46	1.24	0.23	0.0	3	3
1.59	0.43	1.29	0.23	0.0	3	3
1.67	0.34	1.35	0.22	0.0	3	3
1.67	0.42	1.41	0.15	0.0	3	3
1.87	0.54	1.46	0.25	0.0	3	3
1.90	0.46	1.51	0.25	0.0	3	3
1.99	0.60	1.56	0.27	0.0	3	3
2.14	0.60	1.63	0.29	0.0	3	3
2.22	0.60	1.66	0.33	0.0	3	3
2.23	0.61	1.71	0.30	0.0	3	3

($d_{Limit} = 10\text{ m}$)

30	18.6	-9.9
50	6.0	-9.6
100	9.7	-9.2
150	7.9	-8.8
200	7.6	-8.6
250	9.5	-8.3
300	11.0	-8.1
350	12.4	-7.9
400	13.6	-7.6
450	14.7	-7.4
500	15.6	-7.2
550	16.3	-7.0
600	17.2	-6.9
650	18.1	-6.9
700	18.5	-6.8
750	19.1	-6.3
800	19.6	-6.3
850	20.1	-6.0
900	20.8	-5.8
950	21.1	-5.6
1000	21.6	-5.6

0.29	0.04	0.23	0.02	-10.5	10	3
0.39	0.09	0.32	0.08	-10.5	10	3
0.56	0.14	0.47	0.08	-10.5	10	3
0.73	0.20	0.59	0.12	-10.5	10	3
0.84	0.21	0.70	0.11	-10.5	10	3
0.98	0.24	0.80	0.13	-10.5	10	3
1.04	0.26	0.89	0.15	-10.5	10	3
1.18	0.31	0.96	0.13	-10.5	10	3
1.28	0.35	1.03	0.19	-10.5	10	3
1.39	0.38	1.11	0.22	-10.5	10	3
1.44	0.39	1.20	0.19	-10.5	10	3
1.55	0.46	1.24	0.23	-10.5	10	3
1.59	0.43	1.29	0.23	-10.5	10	3
1.67	0.34	1.35	0.22	-10.5	10	3
1.67	0.42	1.41	0.15	-10.5	10	3
1.87	0.54	1.46	0.25	-10.5	10	3
1.90	0.46	1.51	0.25	-10.5	10	3
1.99	0.60	1.56	0.27	-10.5	10	3
2.14	0.60	1.63	0.29	-10.5	10	3
2.22	0.60	1.66	0.33	-10.5	10	3
2.23	0.61	1.71	0.30	-10.5	10	3

Sample calculation

$$E \text{ (dB } \mu\text{V/m)} = U \text{ (dB } \mu\text{V)} + \text{AF (dB 1/m)} + \text{Corr. (dB)}$$

U = Receiver reading

AF = Antenna factor

Corr. = sum of single correction factors of used cables, switch unit, distance correction, amplifier (if applicable)

distance correction = $-20 * \text{LOG} (d_{Limit} / d_{used})$

Linear interpolation will be used for frequencies in between the values in the table.

Tables show an extract of values.

7.4 ANTENNA R&S HF907 (1 GHZ – 18 GHZ)

Frequency	AF R&S HF907	Corr.
MHz	dB (1/m)	dB
1000	24.4	-19.4
2000	28.5	-17.4
3000	31.0	-16.1
4000	33.1	-14.7
5000	34.4	-13.7
6000	34.7	-12.7
7000	35.6	-11.0

cable loss 1 (relay + cable inside chamber)	cable loss 2 (outside chamber)	cable loss 3 (switch unit, attenuator & pre-amp)	cable loss 4 (to receiver)		
dB	dB	dB	dB		
0.99	0.31	-21.51	0.79		
1.44	0.44	-20.63	1.38		
1.87	0.53	-19.85	1.33		
2.41	0.67	-19.13	1.31		
2.78	0.86	-18.71	1.40		
2.74	0.90	-17.83	1.47		
2.82	0.86	-16.19	1.46		

Frequency	AF R&S HF907	Corr.
MHz	dB (1/m)	dB
3000	31.0	-23.4
4000	33.1	-23.3
5000	34.4	-21.7
6000	34.7	-21.2
7000	35.6	-19.8

cable loss 1 (relay inside chamber)	cable loss 2 (inside chamber)	cable loss 3 (outside chamber)	cable loss 4 (switch unit, attenuator & pre-amp)	cable loss 5 (to receiver)	used for FCC 15.247
dB	dB	dB	dB	dB	
0.47	1.87	0.53	-27.58	1.33	
0.56	2.41	0.67	-28.23	1.31	
0.61	2.78	0.86	-27.35	1.40	
0.58	2.74	0.90	-26.89	1.47	
0.66	2.82	0.86	-25.58	1.46	

Frequency	AF R&S HF907	Corr.
MHz	dB (1/m)	dB
7000	35.6	-57.3
8000	36.3	-56.3
9000	37.1	-55.3
10000	37.5	-56.2
11000	37.5	-55.3
12000	37.6	-53.7
13000	38.2	-53.5
14000	39.9	-56.3
15000	40.9	-54.1
16000	41.3	-54.1
17000	42.8	-54.4
18000	44.2	-54.7

cable loss 1 (relay inside chamber)	cable loss 2 (High Pass)	cable loss 3 (pre-amp)	cable loss 4 (inside chamber)	cable loss 5 (outside chamber)	cable loss 6 (to receiver)
dB	dB	dB	dB	dB	dB
0.56	1.28	-62.72	2.66	0.94	1.46
0.69	0.71	-61.49	2.84	1.00	1.53
0.68	0.65	-60.80	3.06	1.09	1.60
0.70	0.54	-61.91	3.28	1.20	1.67
0.80	0.61	-61.40	3.43	1.27	1.70
0.84	0.42	-59.70	3.53	1.26	1.73
0.83	0.44	-59.81	3.75	1.32	1.83
0.91	0.53	-63.03	3.91	1.40	1.77
0.98	0.54	-61.05	4.02	1.44	1.83
1.23	0.49	-61.51	4.17	1.51	1.85
1.36	0.76	-62.36	4.34	1.53	2.00
1.70	0.53	-62.88	4.41	1.55	1.91

Sample calculation

$E \text{ (dB } \mu\text{V/m)} = U \text{ (dB } \mu\text{V)} + AF \text{ (dB 1/m)} + Corr. \text{ (dB)}$
 U = Receiver reading
 AF = Antenna factor
 Corr. = sum of single correction factors of used cables, switch unit, distance correction, amplifier (if applicable)
 Linear interpolation will be used for frequencies in between the values in the table.
 Tables show an extract of values.

7.5 ANTENNA EMCO 3160-09 (18 GHZ – 26.5 GHZ)

Frequency MHz	AF EMCO 3160-09 dB (1/m)	Corr. dB	cable loss 1 (inside chamber) dB	cable loss 2 (pre- amp) dB	cable loss 3 (inside chamber) dB	cable loss 4 (switch unit) dB	cable loss 5 (to receiver) dB
18000	40.2	-23.5	0.72	-35.85	6.20	2.81	2.65
18500	40.2	-23.2	0.69	-35.71	6.46	2.76	2.59
19000	40.2	-22.0	0.76	-35.44	6.69	3.15	2.79
19500	40.3	-21.3	0.74	-35.07	7.04	3.11	2.91
20000	40.3	-20.3	0.72	-34.49	7.30	3.07	3.05
20500	40.3	-19.9	0.78	-34.46	7.48	3.12	3.15
21000	40.3	-19.1	0.87	-34.07	7.61	3.20	3.33
21500	40.3	-19.1	0.90	-33.96	7.47	3.28	3.19
22000	40.3	-18.7	0.89	-33.57	7.34	3.35	3.28
22500	40.4	-19.0	0.87	-33.66	7.06	3.75	2.94
23000	40.4	-19.5	0.88	-33.75	6.92	3.77	2.70
23500	40.4	-19.3	0.90	-33.35	6.99	3.52	2.66
24000	40.4	-19.8	0.88	-33.99	6.88	3.88	2.58
24500	40.4	-19.5	0.91	-33.89	7.01	3.93	2.51
25000	40.4	-19.3	0.88	-33.00	6.72	3.96	2.14
25500	40.5	-20.4	0.89	-34.07	6.90	3.66	2.22
26000	40.5	-21.3	0.86	-35.11	7.02	3.69	2.28
26500	40.5	-21.1	0.90	-35.20	7.15	3.91	2.36

Sample calculation

$E \text{ (dB } \mu\text{V/m)} = U \text{ (dB } \mu\text{V)} + AF \text{ (dB 1/m)} + Corr. \text{ (dB)}$
 U = Receiver reading
 AF = Antenna factor
 Corr. = sum of single correction factors of used cables, switch unit, distance correction, amplifier (if applicable)
 Linear interpolation will be used for frequencies in between the values in the table.
 Table shows an extract of values.

7.6 ANTENNA EMCO 3160-10 (26.5 GHZ – 40 GHZ)

Frequency GHz	AF EMCO 3160-10 dB (1/m)	Corr. dB	cable loss 1 (inside chamber) dB	cable loss 2 (outside chamber) dB	cable loss 3 (switch unit) dB	cable loss 4 (to receiver) dB	distance corr. (-20 dB/ decade) dB	d _{Limit} (meas. distance (limit) m	d _{used} (meas. distance (used) m
26.5	43.4	-11.2	4.4				-9.5	3	1.0
27.0	43.4	-11.2	4.4				-9.5	3	1.0
28.0	43.4	-11.1	4.5				-9.5	3	1.0
29.0	43.5	-11.0	4.6				-9.5	3	1.0
30.0	43.5	-10.9	4.7				-9.5	3	1.0
31.0	43.5	-10.8	4.7				-9.5	3	1.0
32.0	43.5	-10.7	4.8				-9.5	3	1.0
33.0	43.6	-10.7	4.9				-9.5	3	1.0
34.0	43.6	-10.6	5.0				-9.5	3	1.0
35.0	43.6	-10.5	5.1				-9.5	3	1.0
36.0	43.6	-10.4	5.1				-9.5	3	1.0
37.0	43.7	-10.3	5.2				-9.5	3	1.0
38.0	43.7	-10.2	5.3				-9.5	3	1.0
39.0	43.7	-10.2	5.4				-9.5	3	1.0
40.0	43.8	-10.1	5.5				-9.5	3	1.0

Sample calculation

$$E \text{ (dB } \mu\text{V/m)} = U \text{ (dB } \mu\text{V)} + \text{AF (dB 1/m)} + \text{Corr. (dB)}$$

U = Receiver reading

AF = Antenna factor

Corr. = sum of single correction factors of used cables, switch unit, distance correction, amplifier (if applicable)

Linear interpolation will be used for frequencies in between the values in the table.

distance correction = $-20 * \text{LOG} (d_{\text{Limit}} / d_{\text{used}})$

Linear interpolation will be used for frequencies in between the values in the table.

Table shows an extract of values.

8 MEASUREMENT UNCERTAINTIES

Test Case	Parameter	Uncertainty
Conducted Emissions at AC mains	Voltage	± 3.4 dB
Radiated Emissions	Field Strength	± 5.5 dB

9 PHOTO REPORT

Please see separate photo report.