

Setup Guide

Vaisala TempCast
FMP102, FMP103

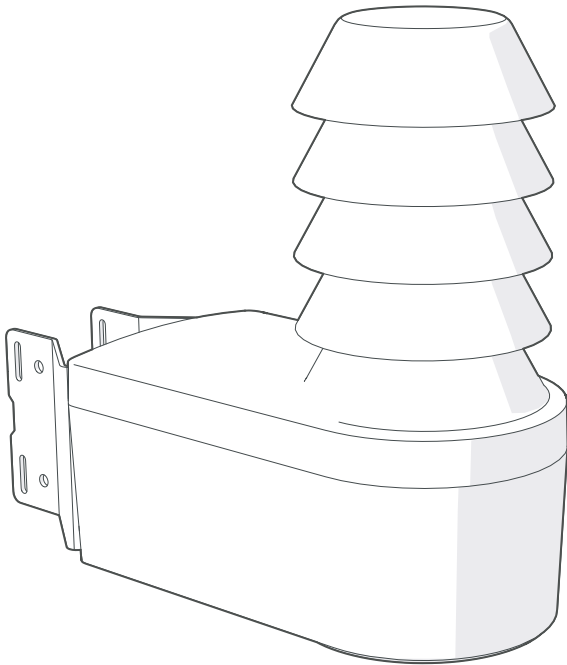

VAISALA

Vaisala TempCast

Vaisala TempCast is a wireless and self-powered sensor, with different variants to measure air temperature, relative humidity, and surface temperature.

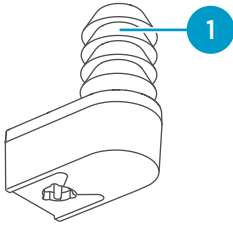

FMP102

1 Temperature and relative humidity sensor

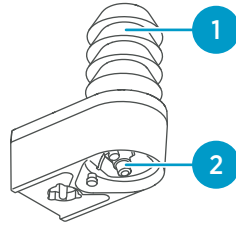

FMP103

1 Temperature and relative humidity sensor
2 Surface temperature sensor

Installation site requirements

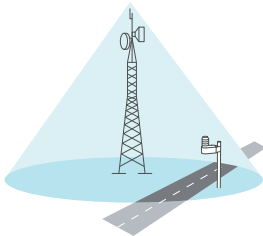

Check that the installation location is within the NB-IoT network coverage area of the network operator.

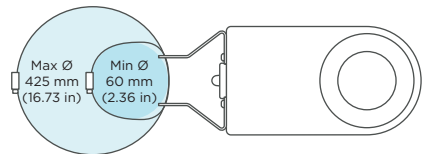

Mount the device on a pole mast with diameter 60 ... 425 mm (2.36 ... 16.73 in).

Setting up device

To set up the device:

1. Activate the device at the installation location using the Vaisala Cast™ Connect mobile application.
2. Install the device at the installation location.
3. Align the surface temperature sensor (only for FMP103).

Included in the product

- Vaisala TempCast sensor
FMP102 or FMP103
- Mounting bracket with steel bands
- Locking key
- Alignment tool

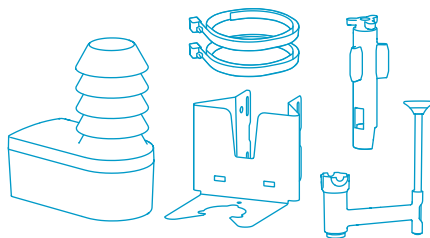

Other needed equipment

- Android phone with NFC reader and Bluetooth
- Vaisala Cast Connect mobile application
- 7-mm socket wrench or flat head screwdriver
- Tin snips (for cutting steel band)
- Aerial work platform
- Protective clothing (PPE)
- Road safety equipment

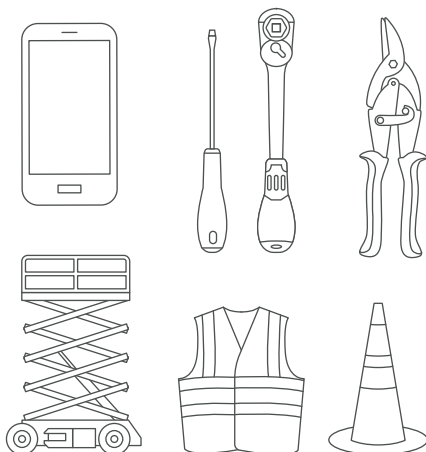

1. Activating device

Activate the device at the installation location.

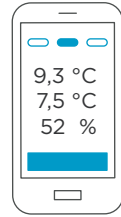

1.1 Download the Vaisala Cast Connect mobile application from Google Play.

1.2 Open the mobile application and select Connect to device.

1.3 Select the **Measurements** tab to view the device measurements.

Hold the phone close to the NFC symbol and wait until the device and phone are paired with Bluetooth.

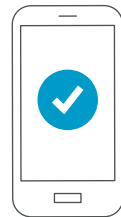
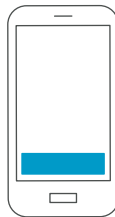

1.4 Check the signal strength from the **Connection** tab and wait until the cloud connection is established.

1.5 Select **Start activation**.

Follow the onscreen instructions.

1.6 Complete the activation. The device is sending measurements to the cloud.

Establishing the cloud connection may take several minutes.



To relocate device or change activation information

Connect to the device with Vaisala Cast Connect, and deactivate and activate the device again.

2. Installing device

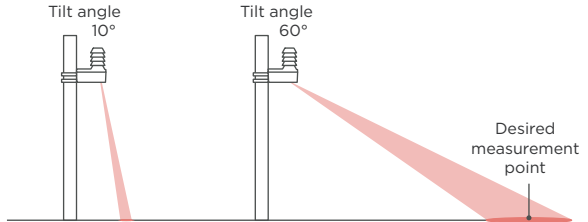
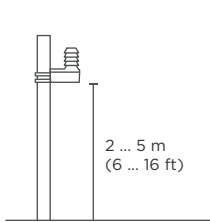

2.1 Select the installation height.

The recommended installation height is 2 ... 5 meters (6 ... 16 ft). Low installation height is more representative of the temperature and relative humidity near the road surface.

For the surface temperature measurement, select the installation height so that you can aim the sensor at the desired measurement point (max. tilt angle 60°).

Note! A large tilt angle may extend the surface temperature measurement area outside the desired measurement point.

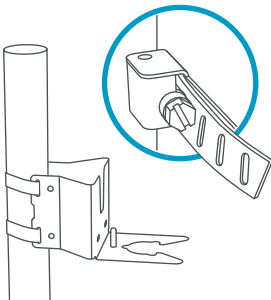

2.2 Fasten the mounting bracket. Cut off excess steel band or place it neatly into the bracket.

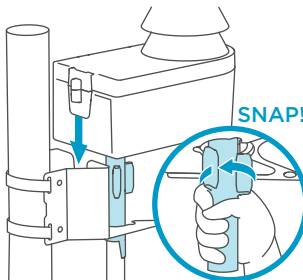

2.3 Use the locking key to lift and secure the device to the bracket. Remove the locking key.

3. Aligning surface temperature sensor (FMP103 only)

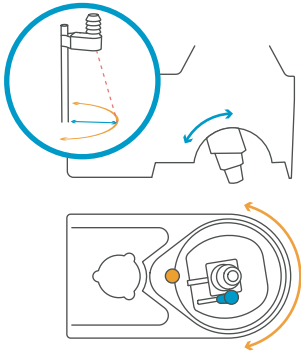

3.1 Loosen the finger screws to adjust the sensor angles. The sensor rotates 180° and tilts 60°.

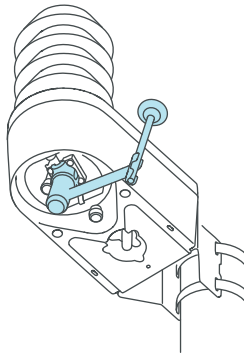

3.2 Attach the alignment tool on the sensor. The tool can be positioned on either side of the device.

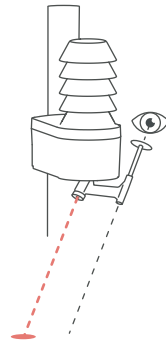

3.3 Look through the alignment tool to aim the sensor at the measurement point. Tighten the finger screws and remove the tool.

Note! The offset from the tool to the sensor is 10 cm (3.94 in).

Replacing and recycling device

At the end of its 3-year lifetime the device needs to be replaced. Use the telescopic rod to install the new device to the existing bracket. Activate the new device using the Vaisala Cast Connect mobile application.

Included in the product

- Vaisala TempCast sensor
FMP102 or FMP103
- Locking key
- Telescopic rod

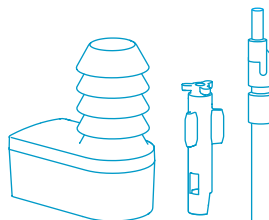

Other needed equipment

- Android phone with NFC reader and Bluetooth
- Vaisala Cast Connect mobile application
- Protective clothing
- Road safety equipment
- 3-mm Allen key

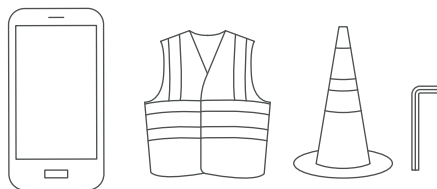

1. Replacing device



1.1 Attach the locking key to the telescopic rod.

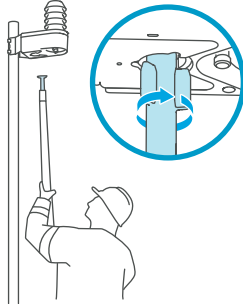

1.2 Turn the locking key to release the device and lift the device from the bracket.

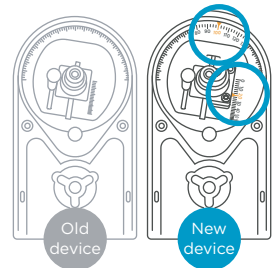

FMP103 only:

1.3 Copy the surface temperature sensor angles to the new device.

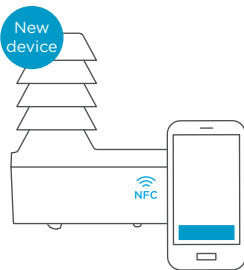

1.4 Open Vaisala Cast Connect and select **Connect to device**.

Hold the phone close to the NFC symbol and wait until the device and phone are paired with Bluetooth.

Select **Start activation**.



1.5 Follow the onscreen instructions to activate the device.

The new device is sending measurements to the cloud.

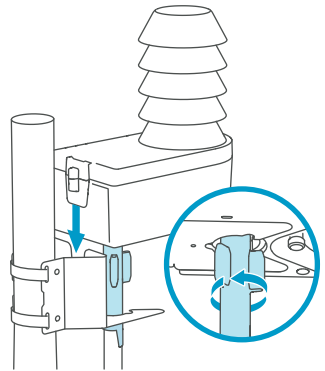

1.6 Lift the new device to the bracket.

2. Removing batteries



WARNING! The sensor contains batteries, which poses a fire, explosion, and severe burn hazard. Do not crush, disassemble, heat above 100 °C (212 °F), or incinerate.



WARNING! The batteries must be removed from the sensor during the recycling. The recycling of batteries must only be conducted by fully trained personnel of licensed recyclers.



WARNING! Do not leave the battery in an environment surrounded by extremely high temperatures. Extremely high temperature can result in an explosion or the leakage of flammable liquid or gas.



WARNING! Make sure that the battery is not subjected to an extremely low air pressure. Extremely low air pressure can result in an explosion or the leakage of flammable liquid or gas.



WARNING! Only use batteries delivered with the sensor by Vaisala.

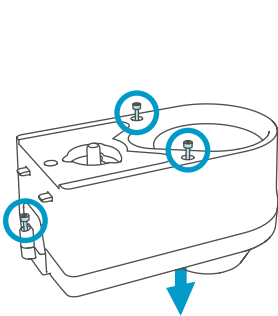

2.1 Loosen 3 screws and remove the cover.

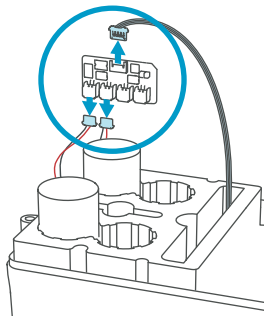

2.2 Detach the power cable.

Detach the battery wires.

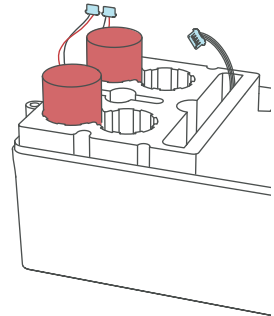

2.3 Remove the batteries.

3. Recycling



These recycling instructions guide you on the end-of-life treatment of this Vaisala product. As waste regulations and infrastructure vary in each country, these instructions only indicate the different components to be separated and common ways to handle them. Always follow local requirements when disposing of the product. Vaisala encourages to use the best available recycling practices to minimize related environmental impacts.



Vaisala is committed to meeting the requirements of the EU Waste Electrical and Electronic Equipment (WEEE) Directive. This directive aims to minimize the impact of electrical and electronic goods on the environment, by increasing reuse and recycling, and reducing the amount of WEEE going to landfill. This symbol indicates that the product should be collected separately from other waste streams and treated appropriately.

- Hazardous battery waste
- Electrical and electronic waste
- Metal waste
- Plastic waste

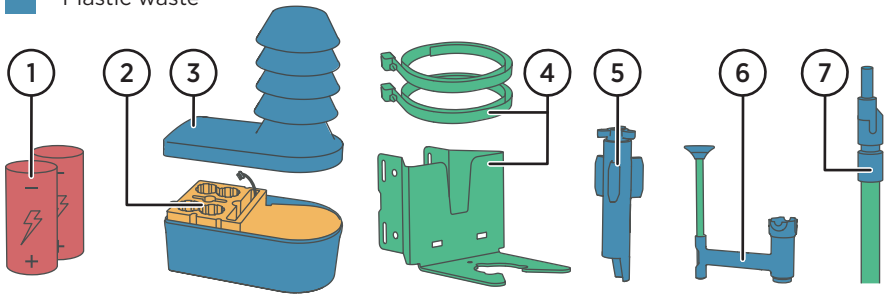

#	Description	Material	Recycling
1	Batteries	Lithium thionyl chloride	Hazardous battery waste
2	Electronics	Various	Electrical and electronic waste
3	Enclosure	Glass fiber reinforced polycarbonate	Plastic waste
4	Mounting bracket and steel bands	Stainless steel	Metal waste
5	Locking key	Polyamide	Plastic waste
6	Alignment tool	Stainless steel, polyoxymethylene	Metal waste, plastic waste
7	Telescopic rod	Aluminum, plastic	Metal waste, plastic waste

If needed, you can send the device to Vaisala for recycling. Contact Vaisala technical support for instructions.

Safety



WARNING! alerts you to a serious hazard. If you do not read and follow instructions carefully at this point, there is a risk of injury or even death.



CAUTION! warns you of a potential hazard. If you do not read and follow instructions carefully at this point, the product could be damaged or important data could be lost.



WARNING! Failure to comply with these precautions or with specific warnings elsewhere in these instructions violates safety standards of design, manufacture, and intended use of the product. Vaisala assumes no liability for the customer's failure to comply with these requirements.



WARNING! Assess the risks from the installation work. Take into account also the effects of local weather conditions.



WARNING! When performing installation and maintenance procedures at the roadside, follow local and state legislation and regulations on road safety



WARNING! Follow local and state legislation and regulations on occupational safety.



WARNING! The sensor contains batteries, which poses a fire, explosion, and severe burn hazard. Do not crush, disassemble, heat above 100 °C (212 °F), or incinerate.



WARNING! The batteries must be removed from the sensor during the recycling. The recycling of batteries must only be conducted by fully trained personnel of licensed recyclers.



WARNING! Do not leave the battery in an environment surrounded by extremely high temperatures. Extremely high temperature can result in an explosion or the leakage of flammable liquid or gas.



WARNING! Make sure that the battery is not subjected to an extremely low air pressure. Extremely low air pressure can result in an explosion or the leakage of flammable liquid or gas.



WARNING! Only use batteries delivered with the sensor by Vaisala.



CAUTION! Changes or modifications to this equipment not expressly approved by the party responsible for compliance could void the user's authority to operate the equipment.



CAUTION! The sensor requires a separation distance of at least 20 cm (7.87 in). This distance must be maintained between the user and the device when the device is operating.



When working with equipment in extremely cold temperatures, use appropriate personal protective equipment such as thermally insulated gloves and clothing.



Wear personal protective equipment (PPE).

Regulatory information:

https://docs.vaisala.com/access/sources/dita/map?aton_code=M212845EN



M212844EN

PUBLISHED BY
Vaisala Oyj
Vanha Nurmijärventie 21
FI-01670 Vantaa, Finland
© Vaisala 2022

All rights reserved. Any logos and/or product names are trademarks of Vaisala or its individual partners. Any reproduction, transfer, distribution or storage of information contained in this document is strictly prohibited. All specifications – technical included – are subject to change without notice.

VAISALA