



# TEST REPORT



**DT&C Co., Ltd.**

42, Yurim-ro, 154Beon-gil, Cheoin-gu, Yongin-si, Gyeonggi-do, Korea,17042  
Tel : 031-321-2664, Fax : 031-321-1664

1. Report No : DRTFCC1806-0164(1)
2. Customer
  - Name : Aurender Inc.
  - Address : #1612, Obiz Tower, 126, Beolmal-ro, Dongan-gu, Anyang-si, Gyeonggi-do, South Korea
3. Use of Report : FCC Original Grant
4. Product Name / Model Name : High Fidelity wireless Receiver / Aurender SW-TX  
FCC ID : 2AO2TAURENDERSWTX
5. Test Method Used : KDB558074 D01v04  
Test Specification : FCC Part 15 Subpart C.247
6. Date of Test : 2018.02.05 ~ 2018.05.29
7. Testing Environment : Refer to appended test report.
8. Test Result : Refer to the attached test result.

Affirmation	Tested by Name : JaeHyeok Bang 	Reviewed by Name : Geunki Son  (Signature)
-------------	---	--

The test results presented in this test report are limited only to the sample supplied by applicant and the use of this test report is inhibited other than its purpose. This test report shall not be reproduced except in full, without the written approval of DT&C Co., Ltd.

2018 . 07 . 13 .

**DT&C Co., Ltd.**

If this report is required to confirmation of authenticity, please contact to [report@dtnc.net](mailto:report@dtnc.net)

## Test Report Version

Test Report No.	Date	Description
DRTFCC1806-0164	Jun. 18, 2018	Initial issue
DRTFCC1806-0164(1)	Jul. 13, 2018	Update address

# Table of Contents

<b>1. General Information</b>	<b>4</b>
1.1 Testing Laboratory	4
1.2 Test Environment	4
1.3 Measurement Uncertainty	4
1.4 Details of Applicant	5
1.5 Description of EUT	5
1.6 Declaration by the applicant / manufacturer	5
1.7 Test Equipment List	6
1.8 Summary of Test Results	7
<b>2. Test Methodology</b>	<b>8</b>
2.1 EUT Configuration	8
2.2 EUT Exercise	8
2.3 General Test Procedures	8
2.4 Description of Test Modes	8
2.5 Instrument Calibration	8
<b>3. Test Result</b>	<b>9</b>
3.1 Maximum Peak Conducted Output Power	9
3.1.1 Test Setup	9
3.1.2 Test Procedures	9
3.1.3 Test Results	9
3.2 6 dB Bandwidth Measurement	12
3.2.1 Test Setup	12
3.2.2 Test Procedures	12
3.2.3 Test Results	12
3.3 Maximum Power Spectral Density	15
3.3.1 Test Setup	15
3.3.2 Test Procedures	15
3.3.3 Test Results	15
3.4 Unwanted Emissions (Conducted)	18
3.4.1 Test Setup	18
3.4.2 Test Procedures	18
3.4.3 Test Results	19
3.5 Unwanted Emissions (Radiated)	27
3.5.1 Test Setup	28
3.5.2 Test Procedures	28
3.5.3 Test Results	29
3.6 Power line Conducted Emissions	30
3.6.1 Test Setup	30
3.6.2 Test Procedures	30
3.6.3 Test Results	31
3.7 Occupied Bandwidth	33
3.7.1 Test Setup	33
3.7.2 Test Procedures	33
3.7.3 Test Results	33
<b>4. ANTENNA REQUIREMENTS</b>	<b>34</b>
<b>APPENDIX I</b>	<b>35</b>
<b>APPENDIX II</b>	<b>36</b>
<b>APPENDIX III</b>	<b>37</b>

# 1. General Information

## 1.1 Testing Laboratory

<b>DT&amp;C Co., Ltd.</b>		
The 3 m test site and conducted measurement facility used to collect the radiated data are located at the 42, Yurim-ro, 154beon-gil, Cheoin-gu, Yongin-si, Gyeonggi-do, Korea 17042. The test site comply with the requirements of § 2.948 according to ANSI C63.4 -2014. - FCC MRA Accredited Test Firm No. : KR0034		
<a href="http://www.dtnc.net">www.dtnc.net</a>		
Telephone	:	+ 82-31-321-2664
FAX	:	+ 82-31-321-1664

## 1.2 Test Environment

Ambient Condition	
• Temperature	+22 °C ~ +25 °C
• Relative Humidity	41 % ~ 45 % R.H.

## 1.3 Measurement Uncertainty

The measurement uncertainties shown below were calculated in accordance with requirements of ANSI C 63.4-2014 and ANSI C 63.10-2013. All measurement uncertainty values are shown with a coverage factor of  $k = 2$  to indicate a 95 % level of confidence.

Test items	Measurement uncertainty
Transmitter Output Power	0.7 dB (The confidence level is about 95 %, $k = 2$ )
Conducted spurious emission	1.0 dB (The confidence level is about 95 %, $k = 2$ )
AC conducted emission	2.4 dB (The confidence level is about 95 %, $k = 2$ )
Radiated spurious emission (1 GHz Below)	5.1 dB (The confidence level is about 95 %, $k = 2$ )
Radiated spurious emission (1 GHz ~ 18 GHz)	5.4 dB (The confidence level is about 95 %, $k = 2$ )
Radiated spurious emission (18 GHz Above)	5.3 dB (The confidence level is about 95 %, $k = 2$ )

## 1.4 Details of Applicant

Applicant : Aurender Inc.  
 Address : #1612, Obiz Tower, 126, Beolmal-ro, Dongan-gu, Anyang-si, Gyeonggi-do, South Korea  
 Contact person : Roy Kim

## 1.5 Description of EUT

<b>EUT</b>	High Fidelity wireless Receiver
<b>Model Name</b>	Aurender SW-TX
<b>Add Model Name</b>	NA
<b>Serial Number</b>	Identical prototype
<b>Power Supply</b>	DC 5 V
<b>Frequency Range</b>	2406 MHz ~ 2476 MHz
<b>Max. RF Output Power</b>	6.68 dBm
<b>Modulation Technique</b>	FSK
<b>Antenna Specification</b>	Antenna Type: Multilayer Chip Antenna Gain: 3.5 dBi (PK)

## 1.6 Declaration by the applicant / manufacturer

N/A

## 1.7 Test Equipment List

Type	Manufacturer	Model	Cal.Date (yy/mm/dd)	Next.Cal. Date (yy/mm/dd)	S/N
Spectrum Analyzer	Agilent Technologies	N9020A	17/07/12	18/07/12	MY46471601
Spectrum Analyzer	Agilent Technologies	N9020A	17/09/05	18/09/05	MY46471251
Multimeter	FLUKE	17B	17/12/26	18/12/26	26030065WS
AC Power Supply	DAEKWANG	5KVA	17/12/28	18/12/28	20060321-1
Signal Generator	Rohde Schwarz	SMBV100A	17/12/27	18/12/27	255571
Signal Generator	Rohde Schwarz	SMF100A	17/12/27	18/12/27	102341
Thermohygrometer	BODYCOM	BJ5478	18/01/03	19/01/03	120612-2
Loop Antenna	Schwarzbeck	FMZB1513	18/01/30	20/01/30	1513-128
BILOG ANTENNA	Schwarzbeck	VULB 9160	16/08/05	18/08/05	9160-3362
Horn Antenna	ETS-LINDGREN	3117	16/05/03	18/05/03	00140394
			18/05/10	20/05/10	
Horn Antenna	A.H.Systems Inc.	SAS-574	17/07/31	19/07/31	155
PreAmplifier	Agilent	8449B	17/09/05	18/09/05	3008A02108
PreAmplifier	HP	8447D	17/12/26	18/12/26	2944A07774
EMI Test Receiver	Rohde Schwarz	ESR7	17/02/16	18/02/16	101061
			18/02/13	19/02/13	
High-pass filter	Wainwright	WHKX12-2580-3000-18000-80SS	17/09/05	18/09/05	3
High-pass filter	Wainwright	WHNX6-6320-8000-26500-40CC	17/09/05	18/09/05	1
Power Meter & Wide Bandwidth Sensor	Anritsu	ML2496A MA2411B	17/12/27	18/12/27	1338004 1306053
EMI TEST RECEIVER	Rohde Schwarz	ESCI7	17/02/16	18/02/16	100910
			18/02/12	19/02/12	
PULSE LIMITER	Rohde Schwarz	ESH3-Z2	17/09/29	18/09/29	101333
LISN	SCHWARZBECK	NNLK 8121	18/03/02	19/03/02	06183
CABLE	DTNC	CABLE	17/06/22	18/06/22	RF-58
CABLE	DTNC	CABLE	17/06/22	18/06/22	RF-82
CABLE	DTNC	CABLE	17/06/22	18/06/22	C-016-4
CABLE	DTNC	CABLE	17/06/22	18/06/22	RF-81
CABLE	Radiall	TESTPRO3	17/06/22	18/06/22	RF-74
CABLE	HUBER+SUHNER	SUCOFLEX103	17/06/22	18/06/22	RF-75
CABLE	Radiall	TESTPRO3	17/06/22	18/06/22	RF-66

Note1: The measurement antennas were calibrated in accordance to the requirements of ANSI C63.5-2017.

Note2: The cable is not a regular calibration item, so it has been calibrated by DT & C itself.

### 1.8 Summary of Test Results

FCC Part	RSS Std.	Parameter	Limit	Test Condition	Status Note 1
15.247(a)	RSS-247 [5.2]	6 dB Bandwidth	> 500 kHz	Conducted	<b>C</b>
15.247(b)	RSS-247 [5.4]	Transmitter Output Power	< 1 Watt		<b>C</b>
15.247(d)	RSS-247 [5.5]	Out of Band Emissions / Band Edge	20 dBc in any 100 kHz BW		<b>C</b>
15.247(e)	RSS-247 [5.2]	Transmitter Power Spectral Density	< 8 dBm/3 kHz		<b>C</b>
-	RSS-Gen [6.7]	Occupied Bandwidth (99 %)	NA		<b>NA</b>
15.247(d) 15.205 15.209	RSS-247 [5.5] RSS-GEN [8.9] RSS-GEN [8.10]	General Field Strength Limits (Restricted Bands and Radiated Emission Limits)	FCC 15.209 limits	Radiated	<b>C</b> Note 2
15.207	RSS-Gen [8.8]	AC Line Conducted Emissions	FCC 15.207 limits	AC Line Conducted	<b>C</b>
15.203	RSS-Gen[6.8]	Antenna Requirements	FCC 15.203	-	<b>C</b>

Note 1: **C**=Comply    **NC**=Not Comply    **NT**=Not Tested    **NA**=Not Applicable  
 Note 2: For radiated emission tests below 30 MHz were performed on semi-anechoic chamber which is correlated with OATS.

## 2. Test Methodology

Generally the tests were performed according to the KDB558074 D01v04. And ANSI C63.10-2013 was used to reference appropriate EUT setup and maximizing procedures of radiated spurious emission and AC line conducted emission testing.

### 2.1 EUT Configuration

The EUT configuration for testing is installed on RF field strength measurement to meet the Commissions requirement and operating in a manner that intends to maximize its emission characteristics in a continuous normal application.

### 2.2 EUT Exercise

The EUT was operated in the test mode to fix the TX frequency that was for the purpose of the measurements. According to its specifications, the EUT must comply with the requirements of the Section 15.207, 15.209 and 15.247 under the FCC Rules Part 15 Subpart C.

### 2.3 General Test Procedures

#### Conducted Emissions

The power-line conducted emission test procedure is not described on the KDB558074 D01v04.

So this test was fulfilled with the requirements in Section 6.2 of ANSI C63.10-2013.

The EUT is placed on the wooden table, which is 0.8 m above ground plane and the conducted emissions from the EUT measured in the frequency range between 0.15 MHz and 30 MHz using CISPR Quasi-peak and Average detector.

#### Radiated Emissions

Basically the radiated tests were performed with KDB558074 D01v04. But some requirements and procedures like test site requirements, EUT setup and maximizing procedure were fulfilled with the requirements in Section 5 and 6 of the ANSI C63.10-2013 as stated on section 12.1 of the KDB558074 D01v04.

The EUT is placed on a non-conductive table. For emission measurements at or below 1 GHz, the table height is 80 cm. For emission measurements above 1 GHz, the table height is 1.5 m. The turntable shall rotate 360 degrees to determine the position of maximum emission level. EUT is set 3 m away from the receiving antenna, which varied from 1 m to 4 m to find out the highest emission. And also, each emission was to be maximized by changing the polarization of receiving antenna both horizontal and vertical. In order to find out the highest emission, the relative positions of the EUT were rotated through three orthogonal axes.

### 2.4 Description of Test Modes

The EUT has been tested with the operating condition for maximizing the emission characteristics. A test program is used to control the EUT for staying in continuous transmitting. The Bluetooth low energy mode with below low, middle and high channels were tested and reported.

Test Mode	Description	Frequency [MHz]		
		Lowest Frequency	Middle Frequency	Highest Frequency
TM 1	FSK	2406	2440	2476

### 2.5 Instrument Calibration

The measuring equipment, which was utilized in performing the tests documented herein, has been calibrated in accordance with the manufacturer's recommendations for utilizing calibration equipment, which is traceable to recognized national standards.



### 3. Test Result

#### 3.1 Maximum Peak Conducted Output Power

##### ▣ Test Requirements and limit, §15.247(b) & RSS-247 [5.4]

A transmitter antenna terminal of EUT is connected to the input of a spectrum analyzer.

Measurement is made while the EUT is operating in transmission mode at the appropriate frequencies.

**The maximum permissible conducted output power is 1 Watt.**

##### 3.1.1 Test Setup

Refer to the APPENDIX I.

##### 3.1.2 Test Procedures

Maximum Peak Conducted Output Power is measured using Measurement Procedure Option 1 of **KDB558074 D01v04**

1. Set the RBW  $\geq$  DTS bandwidth. **Actual RBW = 2.4 MHz**
2. Set VBW  $\geq 3 \times$  RBW. **Actual VBW = 8 MHz**
3. Set span  $\geq 3 \times$  RBW.
4. Sweep time = **auto couple**
5. Detector = **peak**
6. Trace mode = **max hold**
7. Allow trace to fully stabilize
8. Use peak marker function to determine the peak amplitude level.

##### 3.1.3 Test Results

Test mode	Tested Channel	Frame Average Output Power		Peak Output Power	
		dBm	mW	dBm	mW
TM 1	Lowest	4.76	2.99	4.92	3.11
	Middle	<b>5.62</b>	<b>3.65</b>	<b>6.68</b>	<b>4.66</b>
	Highest	-0.52	0.89	1.04	1.27

Note 1 : The frame average output power was tested using an average power meter for reference only.

Note 2 : See next pages for actual measured spectrum plots.

Peak Output Power

TM 1 & Test Channel : Lowest

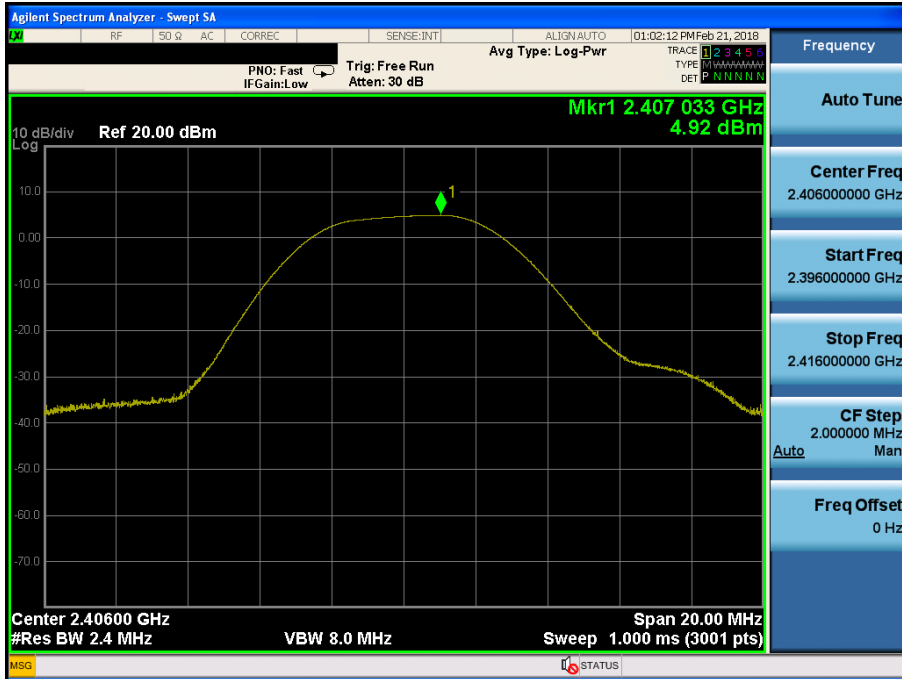

Peak Output Power

TM 1 & Test Channel : Middle

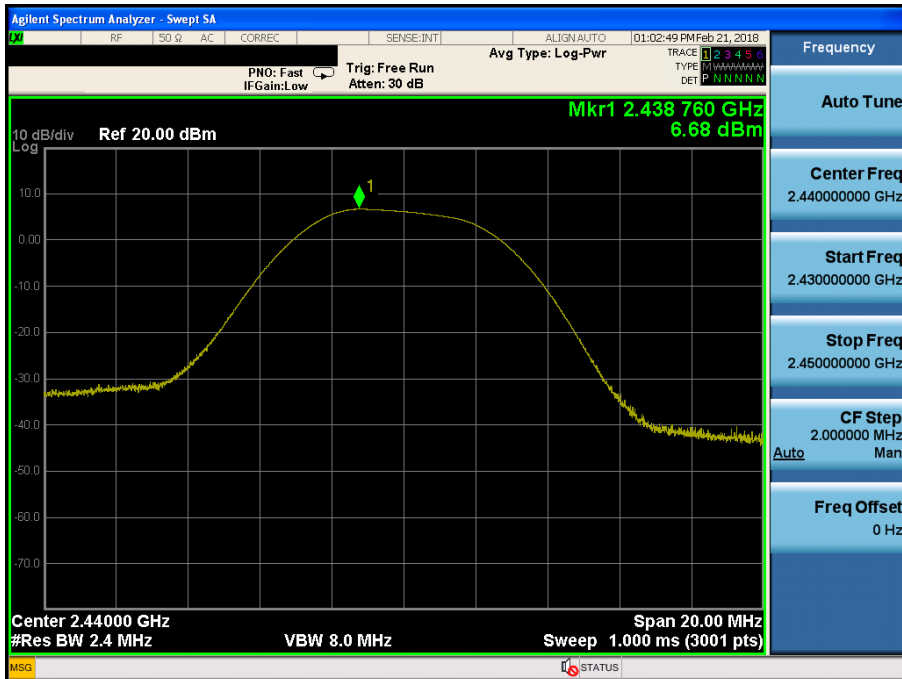



### 3.2 6 dB Bandwidth Measurement

#### ■ Test Requirements and limit, §15.247(a) & RSS-247 [5.2]

The bandwidth at 6 dB down from the highest in-band spectral density is measured with a spectrum analyzer connected to the EUT's antenna terminal while the EUT is operating in transmission mode at the appropriate frequencies.

The minimum permissible 6 dB bandwidth is 500 kHz.

#### 3.2.1 Test Setup

Refer to the APPENDIX I.

#### 3.2.2 Test Procedures

The transmitter output is connected to the Spectrum Analyzer and used following test procedure of KDB558074 D01v04

1. Set resolution bandwidth (RBW) = 100 kHz
2. Set the video bandwidth (VBW)  $\geq 3 \times$  RBW.

**(RBW : 100 kHz / VBW : 300 kHz)**

3. Detector = **peak**.
4. Trace mode = **max hold**.
5. Sweep = **auto couple**.
6. Allow the trace to stabilize.
7. Option 1 - Measure the maximum width of the emission that is constrained by the frequencies associated with the two outermost amplitude points (upper and lower) that are attenuated by 6 dB relative to the maximum level measured in the fundamental emission.

**Option 2 - The automatic bandwidth measurement capability of an instrument may be employed using the X dB bandwidth mode with X set to 6 dB, if the functionality described above (i.e., RBW = 100 kHz, VBW  $\geq 3 \times$  RBW, peak detector with maximum hold) is implemented by the instrumentation function. When using this capability, care shall be taken so that the bandwidth measurement is not influenced by any intermediate power nulls in the fundamental emission that might be  $\geq 6$  dB.**

#### 3.2.3 Test Results

Test Mode	Tested Channel	Test Results [MHz]
TM 1	Lowest	2.149
	Middle	2.145
	Highest	<b>2.188</b>

6 dB Bandwidth

TM 1 & Test Channel : Lowest

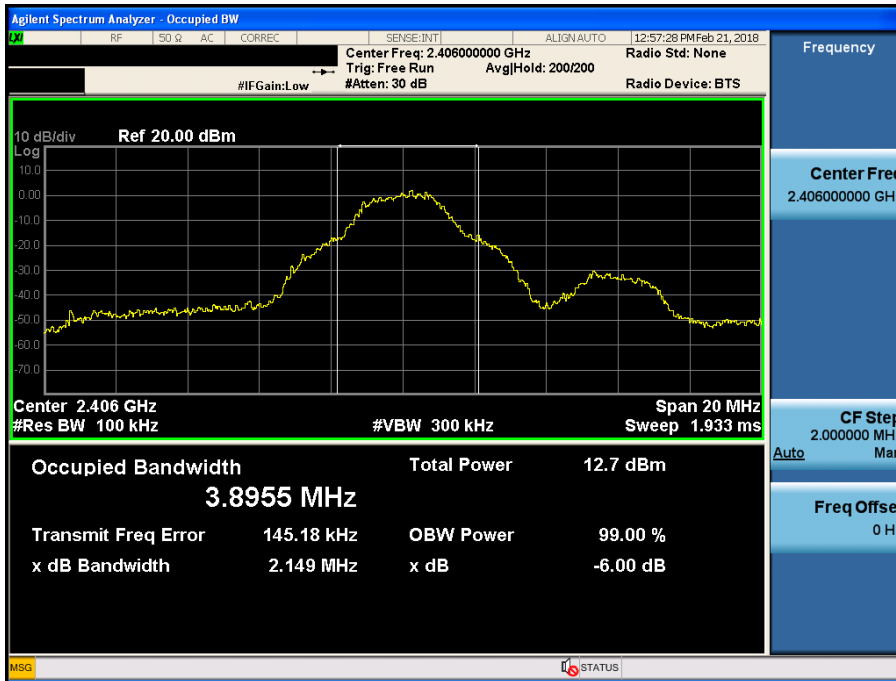

6 dB Bandwidth

TM 1 & Test Channel : Middle

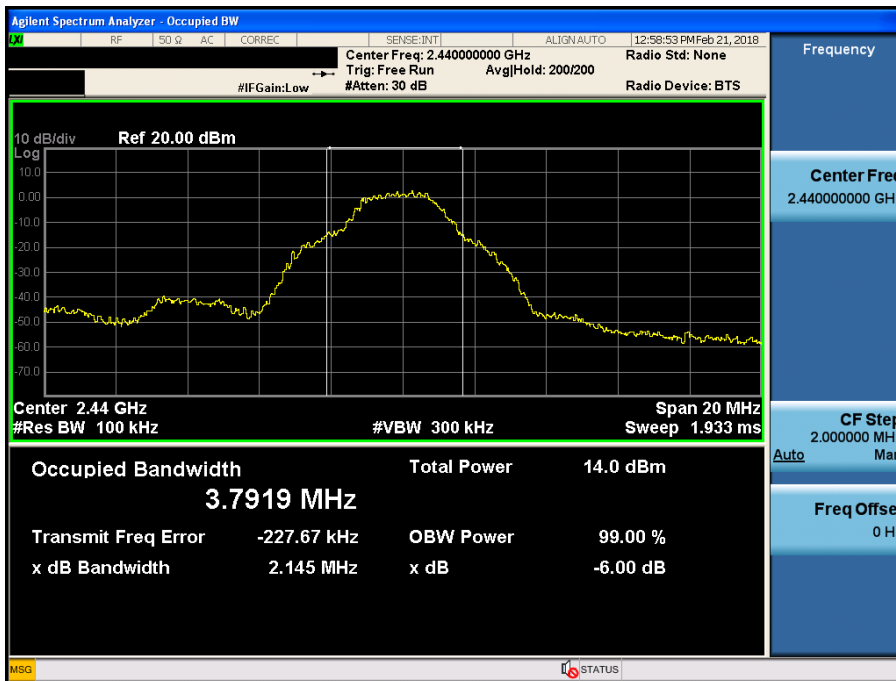

6 dB Bandwidth

TM 1 & Test Channel : Highest

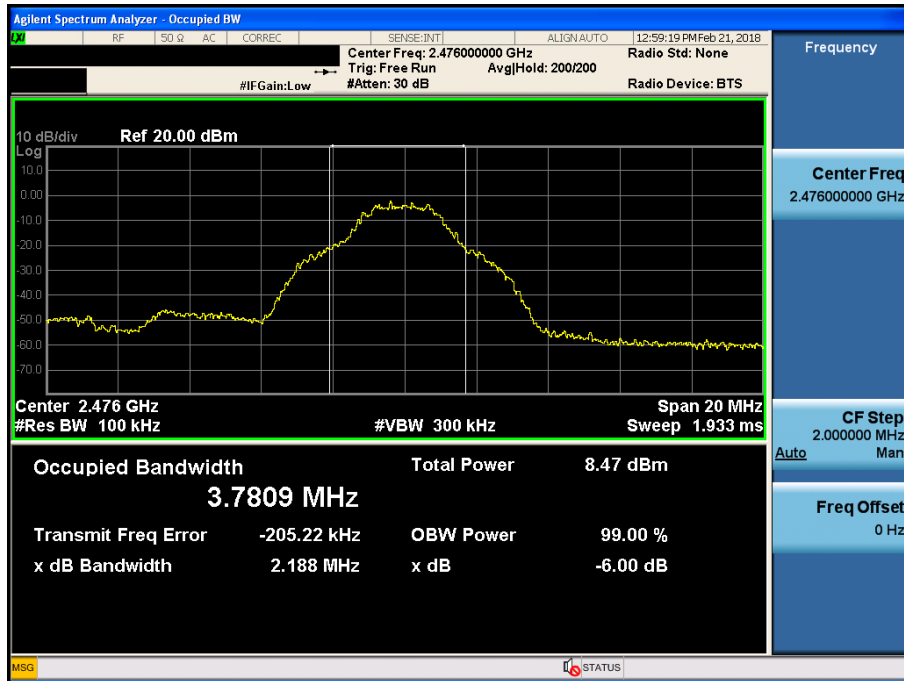

### 3.3 Maximum Power Spectral Density.

#### ▣ Test requirements and limit, §15.247(e) & RSS-247 [5.2]

The peak power density is measured with a spectrum analyzer connected to the antenna terminal while the EUT is operating in transmission mode at the appropriate frequencies.

#### Minimum Standard

The power spectral density conducted from the intentional radiator to the antenna shall not be greater than 8 dBm in any 3 kHz band during any time interval of continuous transmission

#### 3.3.1 Test Setup

Refer to the APPENDIX I.

#### 3.3.2 Test Procedures

Method PKPSD of KDB558074 D01v04 is used.

1. Set analyzer center frequency to DTS channel center frequency.
2. Set the span to **1.5 times** the DTS bandwidth.
3. Set the RBW : **3 kHz ≤ RBW ≤ 100 kHz**.
4. Set the VBW ≥ **3 x RBW**.
5. Detector = **peak**.
6. Sweep time = **auto couple**.
7. Trace mode = **max hold**.
8. Allow trace to fully stabilize.
9. Use the **peak marker function** to determine the maximum amplitude level within the RBW.
10. If measured value exceeds limit, reduce RBW (no less than 3 kHz) and repeat.

#### 3.3.3 Test Results

Test Mode	Tested Channel	PKPSD [dBm]
TM 1	Lowest	-11.91
	Middle	-11.17
	Highest	-16.73

Maximum PKPSD

TM 1 & Test Channel : Lowest

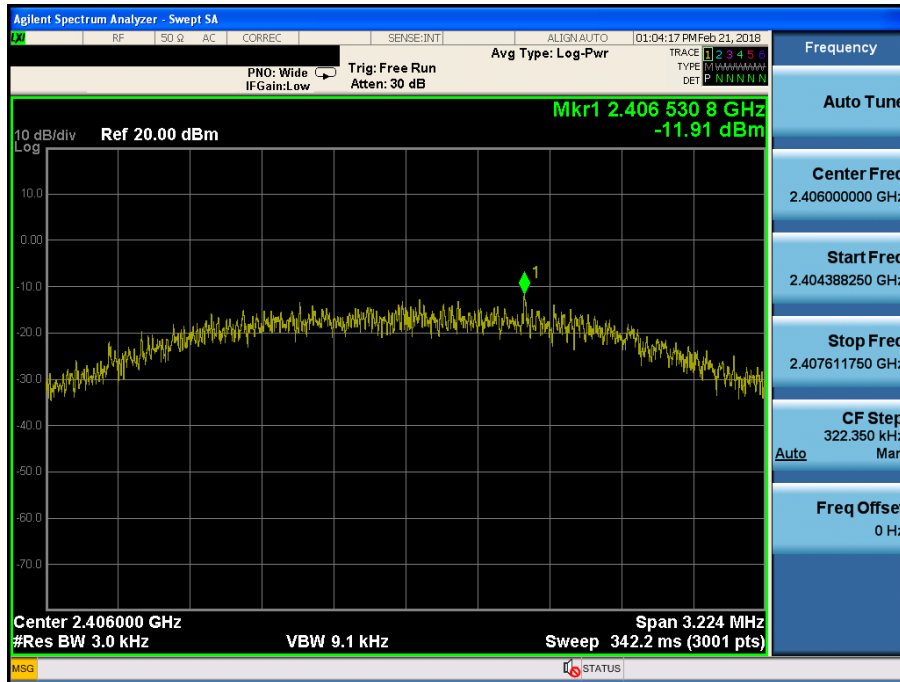

Maximum PKPSD

TM 1 & Test Channel : Middle

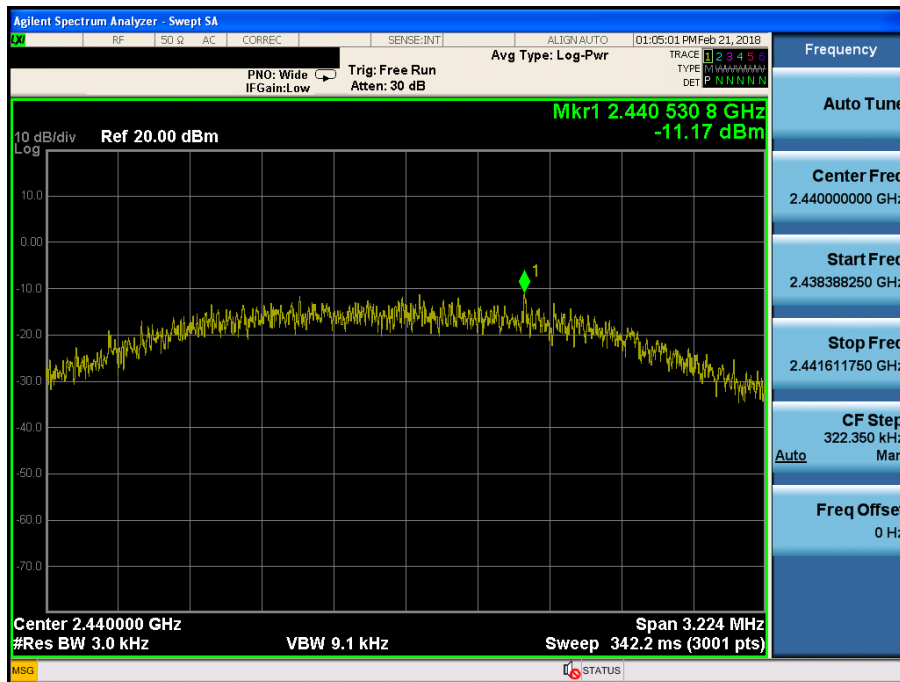



Maximum PKPSD

TM 1 & Test Channel : Highest

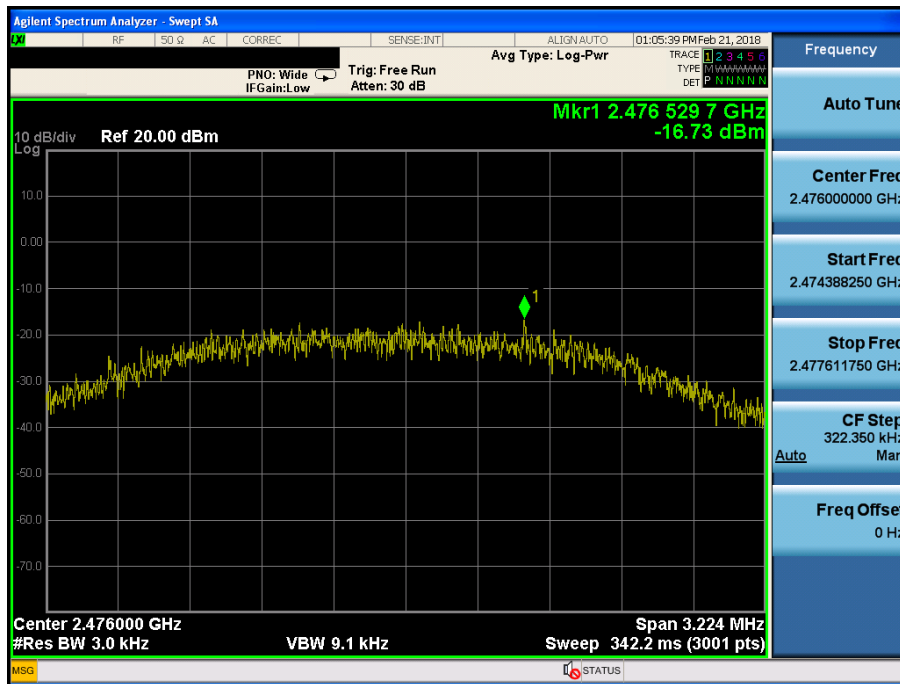

### 3.4 Unwanted Emissions (Conducted)

#### ■ Test requirements and limit, §15.247(d) & RSS-247 [5.5]

§15.247(d) specifies that in any 100 kHz bandwidth outside of the authorized frequency band, the power shall be attenuated according to the following conditions :

If **the peak output power procedure** is used to measure the fundamental emission power to demonstrate compliance to **15.247(b)(3)** requirements, then the peak conducted output power measured within any 100 kHz outside the authorized frequency band shall be attenuated **by at least 20 dB** relative to the maximum measured in-band peak PSD level.

If the average output power procedure is used to measure the fundamental emission power to demonstrate compliance to **15.247(b)(3)** requirements, then the power in any 100 kHz outside of the authorized frequency band shall be attenuated by at least 30 dB relative to the maximum measured inband average PSD level.

In either case, attenuation to levels below the general emission limits specified in §15.209(a) is not required.

#### 3.4.1 Test Setup

Refer to the APPENDIX I including path loss

#### 3.4.2 Test Procedures

The transmitter output is connected to a spectrum analyzer.

##### - Measurement Procedure 1 – Reference Level of KDB558074 D01v04

1. Set instrument center frequency to DTS channel center frequency.
2. Set the span to  $\geq 1.5$  times the DTS bandwidth.
3. Set the RBW = 100 kHz.
4. Set the VBW  $\geq 3 \times$  RBW.
5. Detector = peak.
6. Sweep time = auto couple.
7. Trace mode = max hold.
8. Allow trace to fully stabilize.
9. Use the peak marker function to determine the maximum PSD level  
**LIMIT LINE = 20 dB below of the reference level.**

##### - Measurement Procedure 2 - Unwanted Emissions of KDB558074 D01v04

1. Set the center frequency and span to encompass frequency range to be measured.
2. Set the RBW = **100 kHz.(Actual 1 MHz , See below note)**
3. Set the VBW  $\geq 3 \times$  RBW.**(Actual 3 MHz, See below note)**
4. Detector = **peak**.
5. Ensure that the number of measurement points  $\geq$  span / RBW
6. Sweep time = **auto couple**.
7. Trace mode = **max hold**.
8. **Allow the trace to stabilize** (this may take some time, depending on the extent of the span).
9. Use the peak marker function to determine the maximum amplitude level.

**Note :** The conducted spurious emission was tested with below settings.

Frequency range	RBW	VBW	Detector	Trace	Sweep Point
9 kHz ~ 30 MHz	100 kHz	300 kHz	Peak	Max Hold	40001
30 MHz ~ 10 GHz	1 MHz	3 MHz			
10 GHz ~ 25 GHz	1 MHz	3 MHz			

If the emission level with above setting was close to the limit (ie, less than 3 dB margin) then zoom scan is required using RBW = 100 kHz, VBW = 300 kHz, SPAN = 100 MHz and BINS = 2001 to get accurate emission level within 100 kHz BW.

3.4.3 Test Results

TM 1 Reference (Test Channel : Lowest)

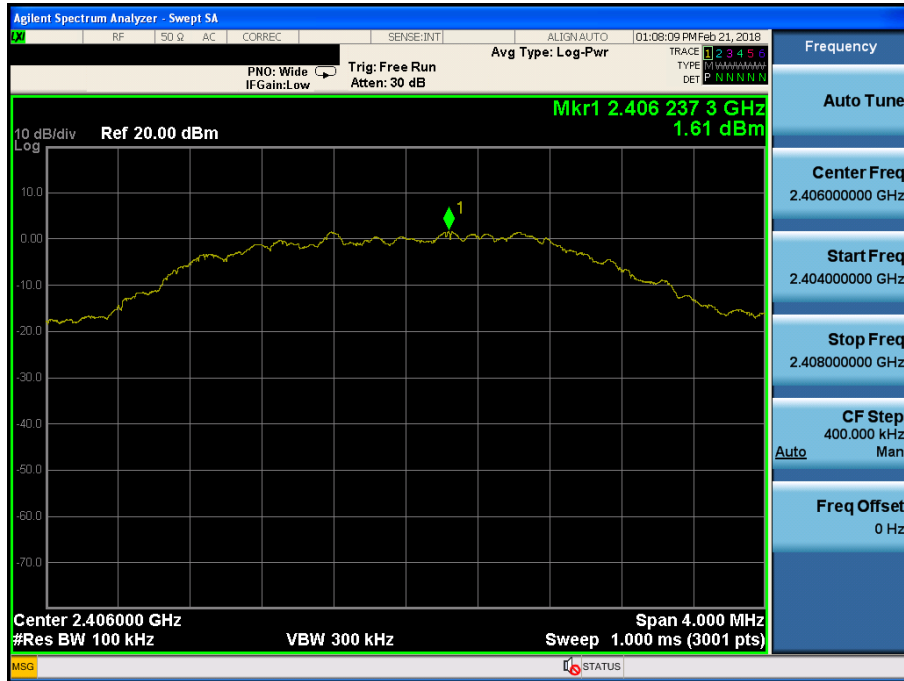

TM 1 Low Band-edge (Test Channel : Lowest)



TM 1 Conducted Spurious Emissions 1 (Test Channel : Lowest)

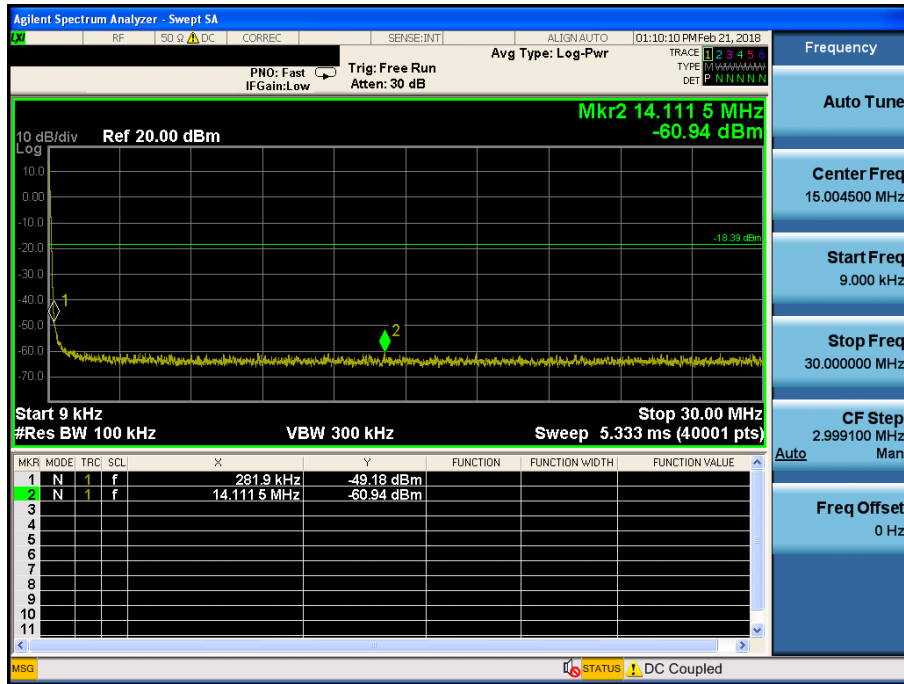

TM 1 Conducted Spurious Emissions 2 (Test Channel : Lowest)

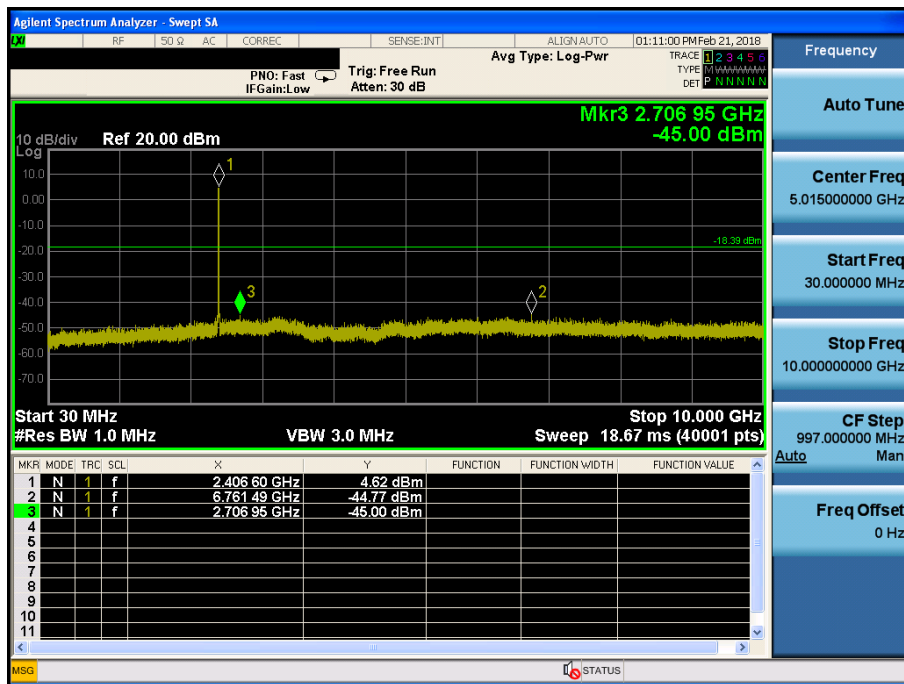

TM 1 Conducted Spurious Emissions 3 (Test Channel : Lowest)

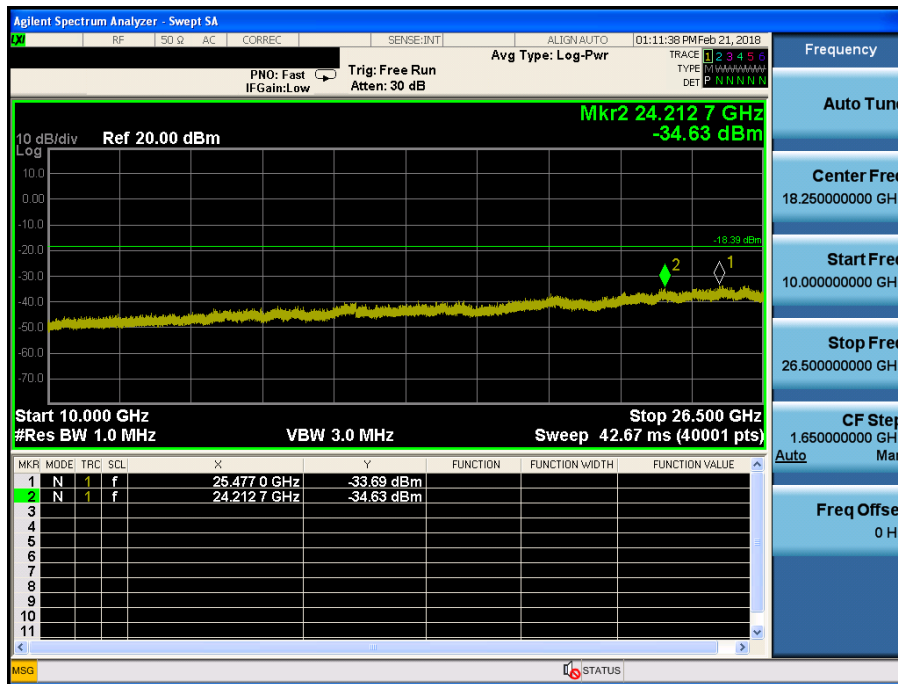

TM 1 Reference (Test Channel : Middle)



TM 1 Conducted Spurious Emissions 1 (Test Channel : Middle)

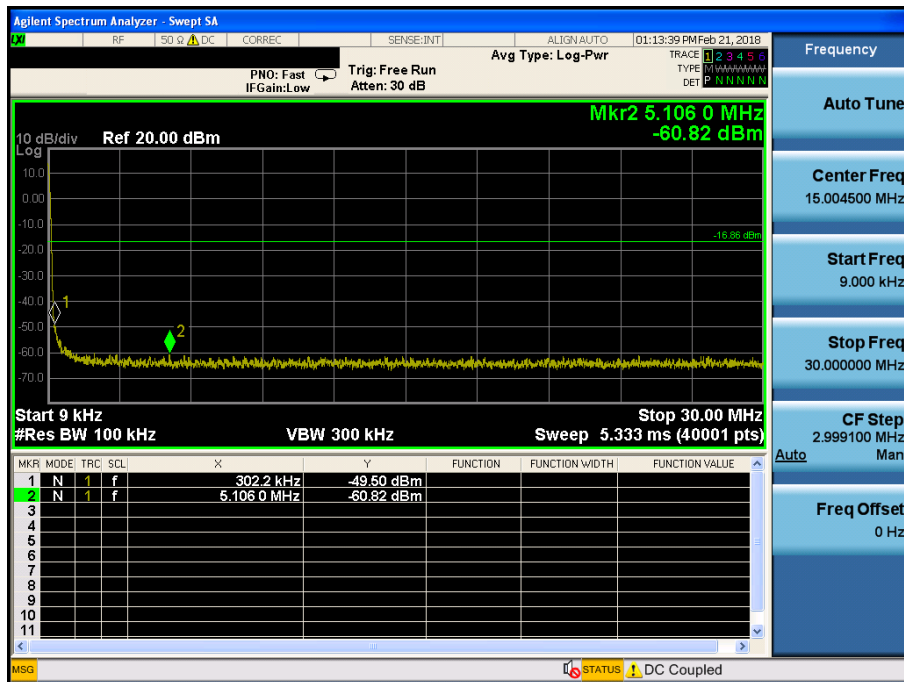

TM 1 Conducted Spurious Emissions 2 (Test Channel : Middle)

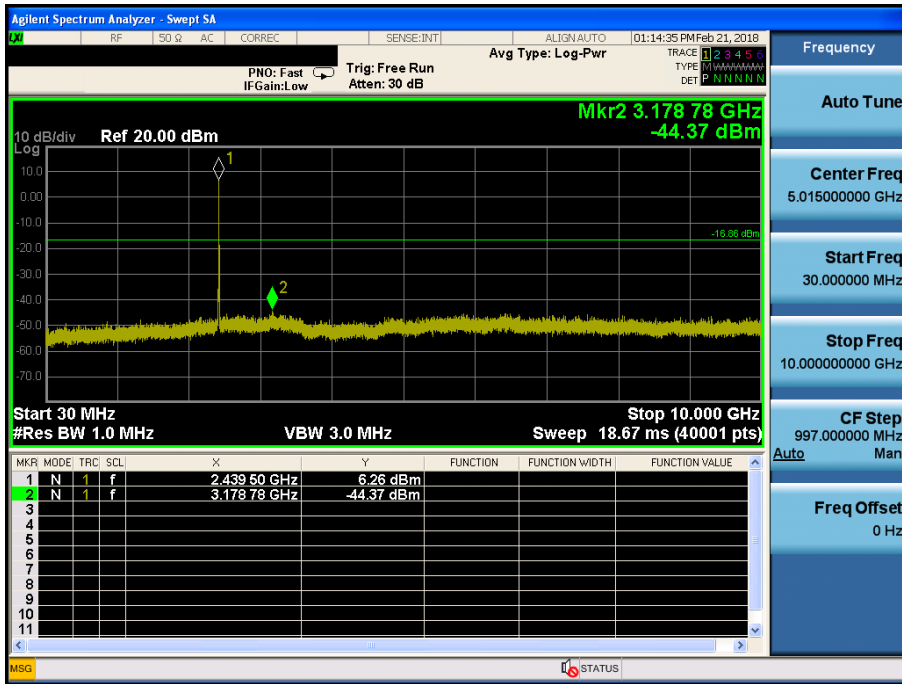

TM 1 Conducted Spurious Emissions 3 (Test Channel : Middle)

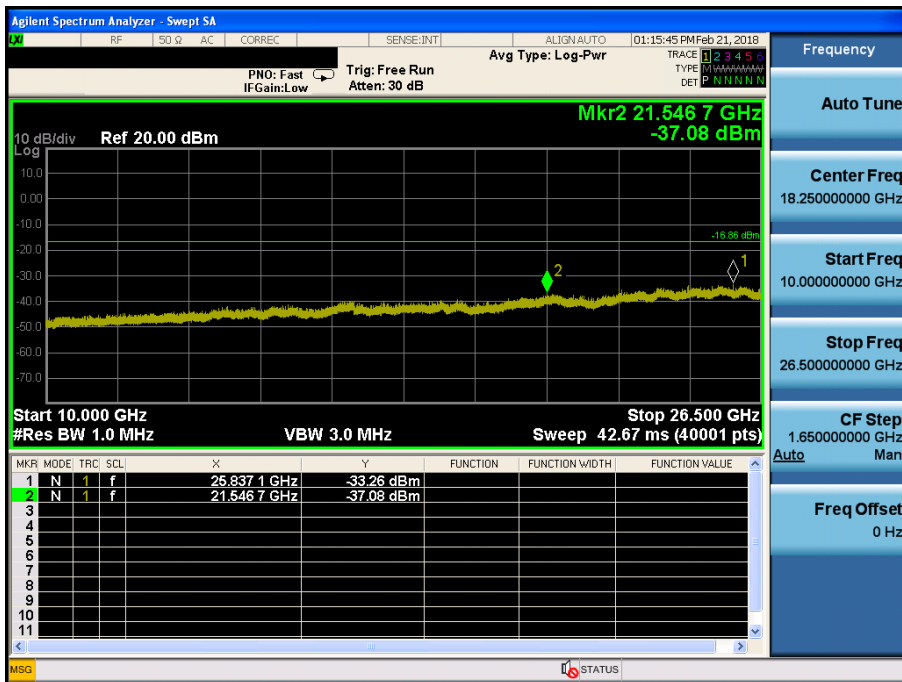

TM 1 Reference (Test Channel : Highest)



TM 1 High Band-edge (Test Channel : Highest)

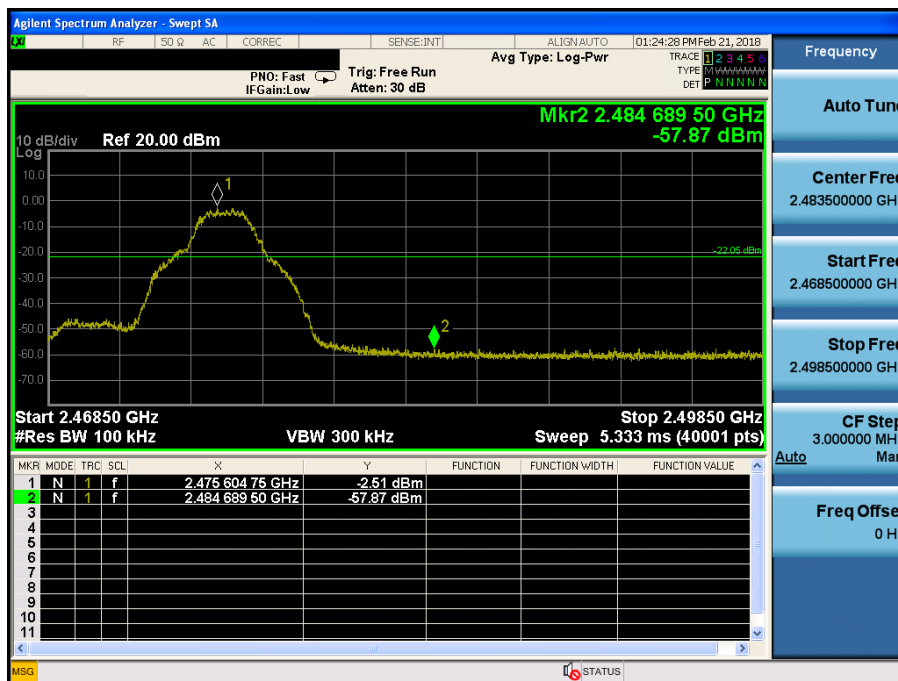



TM 1 Conducted Spurious Emissions 1 (Test Channel : Highest)

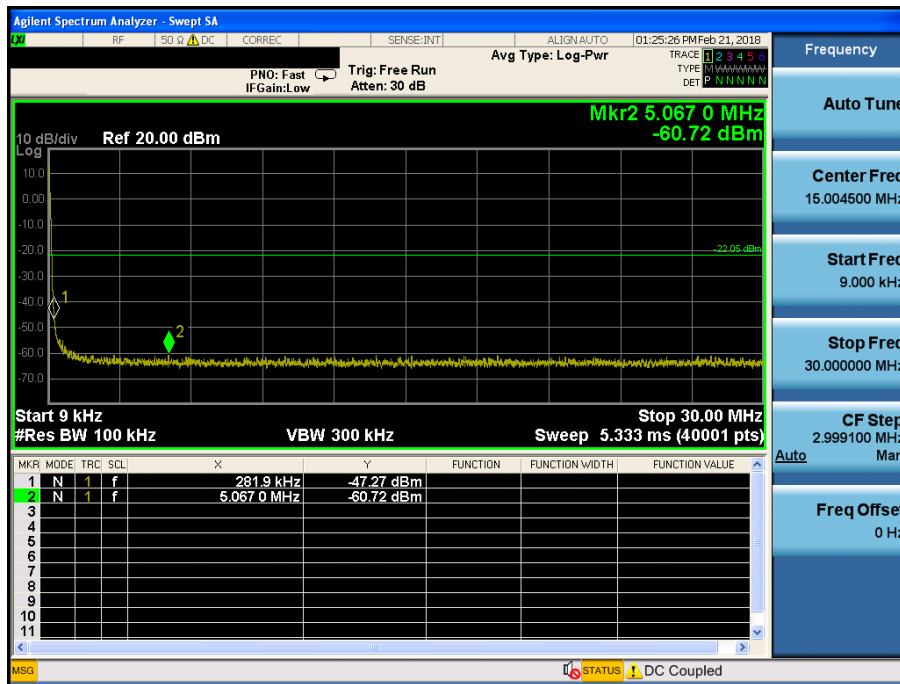

TM 1 Conducted Spurious Emissions 2 (Test Channel : Highest)

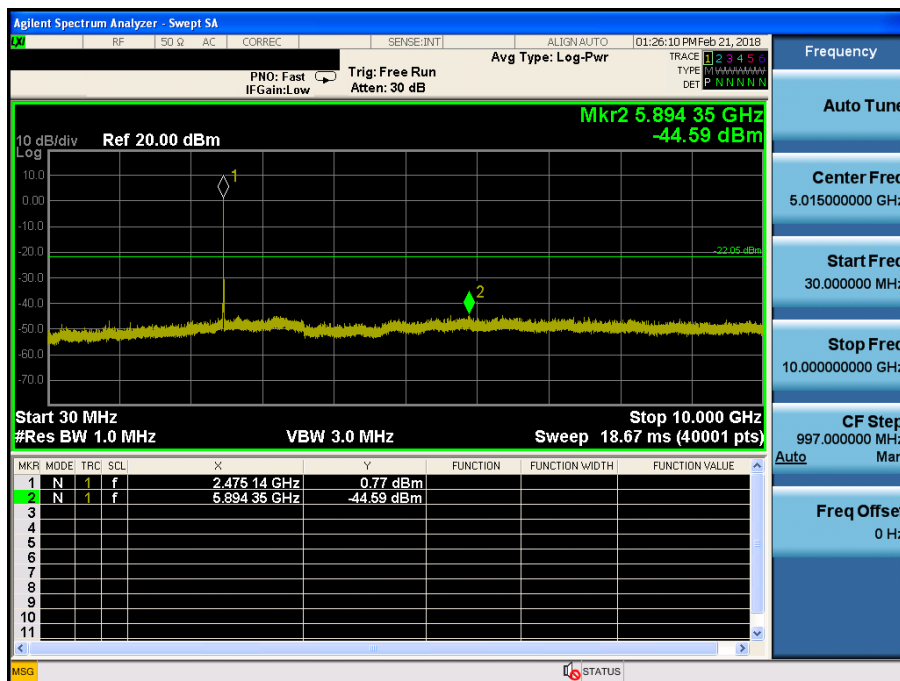

TM 1 Conducted Spurious Emissions 3 (Test Channel : Highest)

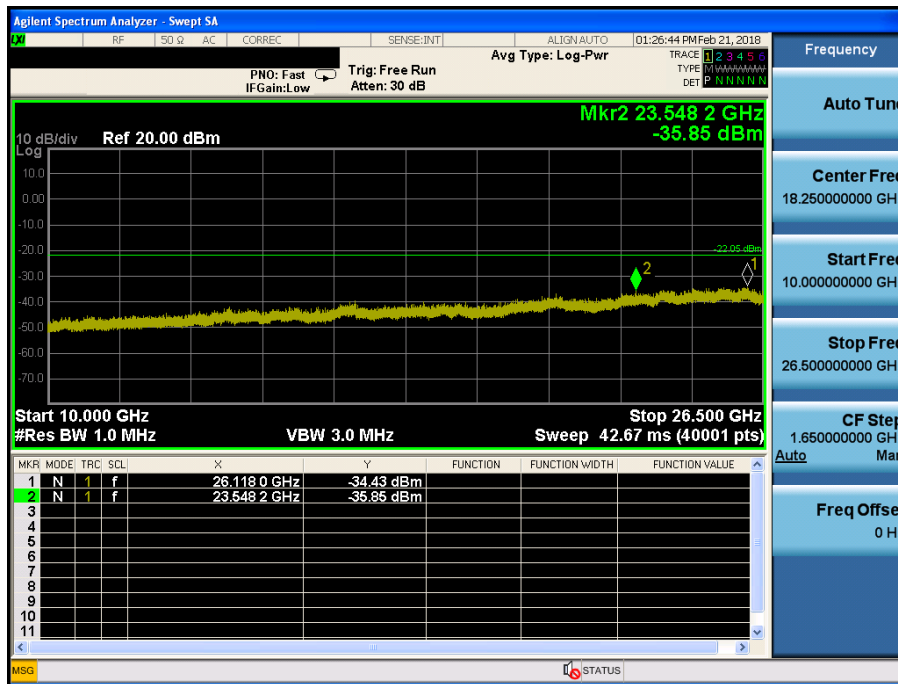

### 3.5 Unwanted Emissions (Radiated)

▣ **Test Requirements and limit,**

**§15.247(d), §15.205, §15.209 & RSS-247 [5.5], RSS-Gen [8.9], RSS-Gen [8.10]**

In any 100 kHz bandwidth outside the operating frequency band. In case the emission fall within the restricted band specified on 15.205(a) and (b), then the 15.209(a) limit in the table below has to be followed.

▪ **FCC Part 15.209(a) and (b)**

Frequency (MHz)	Limit (uV/m)	Measurement Distance (meter)
0.009 ~ 0.490	2400/F (kHz)	300
0.490 ~ 1.705	24000/F (kHz)	30
1.705 ~ 30.0	30	30
30 ~ 88	100 **	3
88 ~ 216	150 **	3
216 ~ 960	200 **	3
Above 960	500	3

\*\* Except as provided in 15.209(g), fundamental emissions from intentional radiators operating under this Section shall not be located in the frequency bands 54 ~ 72 MHz, 76 ~ 88 MHz, 174 ~ 216 MHz or 470 ~ 806 MHz. However, operation within these frequency bands is permitted under other sections of this Part, e.g. 15.231 and 15.241.

▪ **FCC Part 15.205 (a)** : Only spurious emissions are permitted in any of the frequency bands listed below :

MHz	MHz	MHz	MHz	GHz	GHz
0.009 ~ 0.110	8.41425 ~ 8.41475	108 ~ 121.94	1300 ~ 1427	4.5 ~ 5.15	14.47 ~ 14.5
0.495 ~ 0.505	12.29 ~ 12.293	123 ~ 138	1435 ~ 1626.5	5.35 ~ 5.46	15.35 ~ 16.2
2.1735 ~ 2.1905	12.51975 ~	149.9 ~ 150.05	1645.5 ~ 1646.5	7.25 ~ 7.75	17.7 ~ 21.4
4.125 ~ 4.128	12.52025	156.52475 ~	1660 ~ 1710	8.025 ~ 8.5	22.01 ~ 23.12
4.17725 ~ 4.17775	12.57675 ~	156.52525	1718.8 ~ 1722.2	9.0 ~ 9.2	23.6 ~ 24.0
4.20725 ~ 4.20775	12.57725	156.7 ~ 156.9	2200 ~ 2300	9.3 ~ 9.5	31.2 ~ 31.8
6.215 ~ 6.218	13.36 ~ 13.41	162.0125 ~ 167.17	2310 ~ 2390	10.6 ~ 12.7	36.43 ~ 36.5
6.26775 ~ 6.26825	16.42 ~ 16.423	167.72 ~ 173.2	2483.5 ~ 2500	13.25 ~ 13.4	Above 38.6
6.31175 ~ 6.31225	16.69475 ~	240 ~ 285	2655 ~ 2900		
8.291 ~ 8.294	16.69525	322 ~ 335.4	3260 ~ 3267		
8.362 ~ 8.366	16.80425 ~	399.90 ~ 410	3332 ~ 3339		
8.37625 ~ 8.38675	16.80475	608 ~ 614	3345.8 ~ 3358		
	25.5 ~ 25.67	960 ~ 1240	3600 ~ 4400		
	37.5 ~ 38.25				
	73 ~ 74.6				
	74.8 ~ 75.2				

▪ **FCC Part 15.205(b)** : The field strength of emissions appearing within these frequency bands shall not exceed the limits shown in §15.209. At frequencies equal to or less than 1000 MHz, compliance with the limits in §15.209 shall be demonstrated using measurement instrumentation employing a CISPR quasi-peak detector. Above 1000 MHz, compliance with the emission limits in §15.209 shall be demonstrated based on the average value of the measured emissions. The provisions in §15.35 apply to these measurements.

### 3.5.1 Test Setup

Refer to the APPENDIX I.

### 3.5.2 Test Procedures

1. The EUT is placed on a non-conductive table. For emission measurements at or below 1 GHz, the table height is 80 cm. For emission measurements above 1 GHz, the table height is 1.5 m.
2. The turntable shall be rotated for 360 degrees to determine the position of maximum emission level.
3. EUT is set 3 m away from the receiving antenna, which is varied from 1 m to 4 m to find out the highest emissions.
4. Maximum procedure was performed on the six highest emissions to ensure EUT compliance.
5. And also, each emission was to be maximized by changing the polarization of receiving antenna both horizontal and vertical.
6. Repeat above procedures until the measurements for all frequencies are complete.

#### Note: Measurement Instrument Setting for Radiated Emission Measurements.

##### 1. Frequency Range Below 1 GHz

RBW = 100 or 120 kHz, VBW = 3 x RBW, Detector = Peak or Quasi Peak

##### 2. Frequency Range > 1 GHz

###### Peak Measurement > 1 GHz

RBW = 1 MHz, VBW = 3 MHz, Detector = Peak, Sweep time = Auto, Trace mode = Max Hold until the trace stabilizes

###### Average Measurement > 1GHz

1. RBW = 1 MHz (unless otherwise specified).
2.  $VBW \geq 3 \times RBW$ .
3. Detector = RMS (Number of points  $\geq 2 \times \text{Span} / RBW$ )
4. Averaging type = power (i.e., RMS).
5. Sweep time = auto.
6. Perform a trace average of at least 100 traces.
7. A correction factor shall be added to the measurement results prior to comparing to the emission limit in order to compute the emission level that would have been measured had the test been performed at 100 percent duty cycle. The correction factor is computed as follows:
  - 1) If power averaging (RMS) mode was used in step 4, then the applicable correction factor is  $10 \log(1/x)$ , where x is the duty cycle.
  - 2) If linear voltage averaging mode was used in step 4, then the applicable correction factor is  $20 \log(1/x)$ , where x is the duty cycle.
  - 3) If a specific emission is demonstrated to be continuous ( $\geq 98$  percent duty cycle) rather than turning on and off with the transmit cycle, then no duty cycle correction is required for that emission.

Test Mode	Duty Cycle (%)	T <sub>on</sub> (ms)	T <sub>on</sub> + T <sub>off</sub> (ms)	DCF = 10 log(1/Duty) (dB)
TM 1	100	-	-	-

Note : Refer to appendix II for duty cycle measurement procedure and plots

### 3.5.3 Test Results

#### Frequency Range : 9 kHz ~ 25 GHz \_ TM 1

##### ▪ Lowest Channel

Frequency (MHz)	ANT Pol	The worst case EUT Position (Axis)	Detector Mode	Reading (dBuV)	T.F (dB/m)	D.C.F (dB)	Distance Factor(dB)	Result (dBuV/m)	Limit (dBuV/m)	Margin (dB)
2389.70	H	Z	PK	47.84	0.70	N/A	N/A	48.54	74.00	25.46
2389.68	H	Z	AV	38.57	0.70	N/A	N/A	39.27	54.00	14.73
4812.39	V	Z	PK	51.87	4.81	N/A	N/A	56.68	74.00	17.32
4812.13	V	Z	AV	44.46	4.81	N/A	N/A	49.27	54.00	4.73
7217.62	V	Z	PK	48.04	7.70	N/A	N/A	55.74	74.00	18.26
7218.59	V	Z	AV	38.78	7.70	N/A	N/A	46.48	54.00	7.52

##### ▪ Middle Channel

Frequency (MHz)	ANT Pol	The worst case EUT Position (Axis)	Detector Mode	Reading (dBuV)	T.F (dB/m)	D.C.F (dB)	Distance Factor(dB)	Result (dBuV/m)	Limit (dBuV/m)	Margin (dB)
4879.54	V	Z	PK	53.02	5.09	N/A	N/A	58.11	74.00	15.89
4879.57	V	Z	AV	45.81	5.09	N/A	N/A	50.90	54.00	3.10
7318.81	V	Z	PK	48.52	7.60	N/A	N/A	56.12	74.00	17.88
7319.68	V	Z	AV	39.15	7.60	N/A	N/A	46.75	54.00	7.25

##### ▪ Highest Channel

Frequency (MHz)	ANT Pol	The worst case EUT Position (Axis)	Detector Mode	Reading (dBuV)	T.F (dB/m)	D.C.F (dB)	Distance Factor(dB)	Result (dBuV/m)	Limit (dBuV/m)	Margin (dB)
2483.53	H	Z	PK	52.65	0.94	N/A	N/A	53.59	74.00	20.41
2483.58	H	Z	AV	43.02	0.94	N/A	N/A	43.96	54.00	10.04
4951.26	V	Z	PK	51.48	5.32	N/A	N/A	56.80	74.00	17.20
4951.35	V	Z	AV	43.94	5.32	N/A	N/A	49.26	54.00	4.74
7427.38	V	Z	PK	47.67	7.58	N/A	N/A	55.25	74.00	18.75
7427.19	V	Z	AV	37.86	7.58	N/A	N/A	45.44	54.00	8.56

##### ▪ Note.

1. The radiated emissions were investigated 9 kHz to 25 GHz. And no other spurious and harmonic emissions were found above listed frequencies.

2. Information of Distance Factor

For finding emissions, the test distance might be reduced from 3 m to 1 m. In this case, the distance factor (-9.54 dB) is applied to the result.

- Calculation of distance factor =  $20 \log(\text{applied distance} / \text{required distance}) = 20 \log(1 \text{ m} / 3 \text{ m}) = -9.54 \text{ dB}$

When distance factor is "N/A", the distance is 3 m and distance factor is not applied.

3. Sample Calculation.

Margin = Limit – Result / Result = Reading + T.F + D.C.F / T.F = AF + CL – AG

Where, T.F = Total Factor, AF = Antenna Factor, CL = Cable Loss, AG = Amplifier Gain,

DCF = Duty Cycle Correction Factor.

### 3.6 Power line Conducted Emissions

#### ■ Test Requirements and limit, §15.207 & RSS-Gen [8.8]

For an intentional radiator that is designed to be connected to the public utility (AC) power line, the radio frequency voltage that is conducted back onto the AC power line on any frequency or frequencies, within the band 150 kHz to 30 MHz, shall not exceed the limits in the following table, as measured using a 50  $\mu$ H/50 ohms line impedance stabilization network (LISN).

Frequency Range (MHz)	Conducted Limit (dBuV)	
	Quasi-Peak	Average
0.15 ~ 0.5	66 to 56 *	56 to 46 *
0.5 ~ 5	56	46
5 ~ 30	60	50

\* Decreases with the logarithm of the frequency

Compliance with this provision shall be based on the measurement of the radio frequency voltage between each power line (LINE and NEUTRAL) and ground at the power terminals.

#### 3.6.1 Test Setup

See test photographs for the actual connections between EUT and support equipment.

#### 3.6.2 Test Procedures

Conducted emissions from the EUT were measured according to the ANSI C63.10-2013.

1. The test procedure is performed in a 6.5 m  $\times$  3.5 m  $\times$  3.5 m (L  $\times$  W  $\times$  H) shielded room. The EUT along with its peripherals were placed on a 1.0 m (W)  $\times$  1.5 m (L) and 0.8 m in height wooden table and the EUT was adjusted to maintain a 0.4 meter space from a vertical reference plane.
2. The EUT was connected to power mains through a line impedance stabilization network (LISN) which provides 50 ohm coupling impedance for measuring instrument and the chassis ground was bounded to the horizontal ground plane of shielded room.
3. All peripherals were connected to the second LISN and the chassis ground also bounded to the horizontal ground plane of shielded room.
4. The excess power cable between the EUT and the LISN was bundled. The power cables of peripherals were unbundled. All connecting cables of EUT and peripherals were moved to find the maximum emission.

### 3.6.3 Test Results

#### AC Line Conducted Emissions (Graph)

## AC Line Conducted Emission

DTNC

Date 2018-05-29

Order No.  
Model No.  
Serial No.  
Test Condition

DTNC1801-00692  
Aurender SW-TX  
SRD

Reference No.  
Power Supply  
Temp/Humi.  
Operator

120V 60Hz  
23 'C 44% R.H

Memo

LIMIT : FCC P15.207 QP  
FCC P15.207 AV

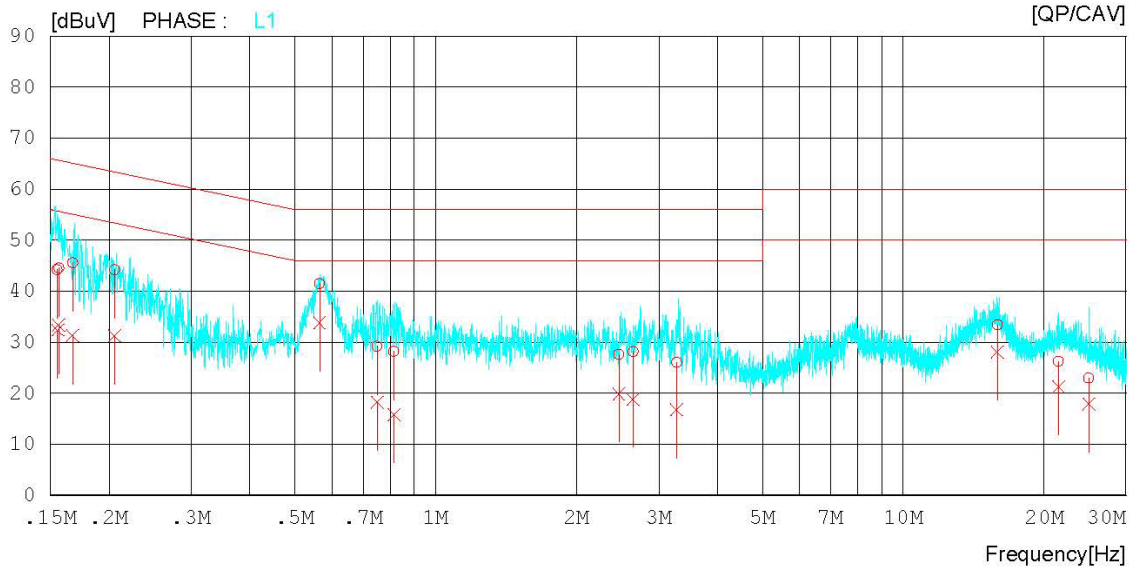
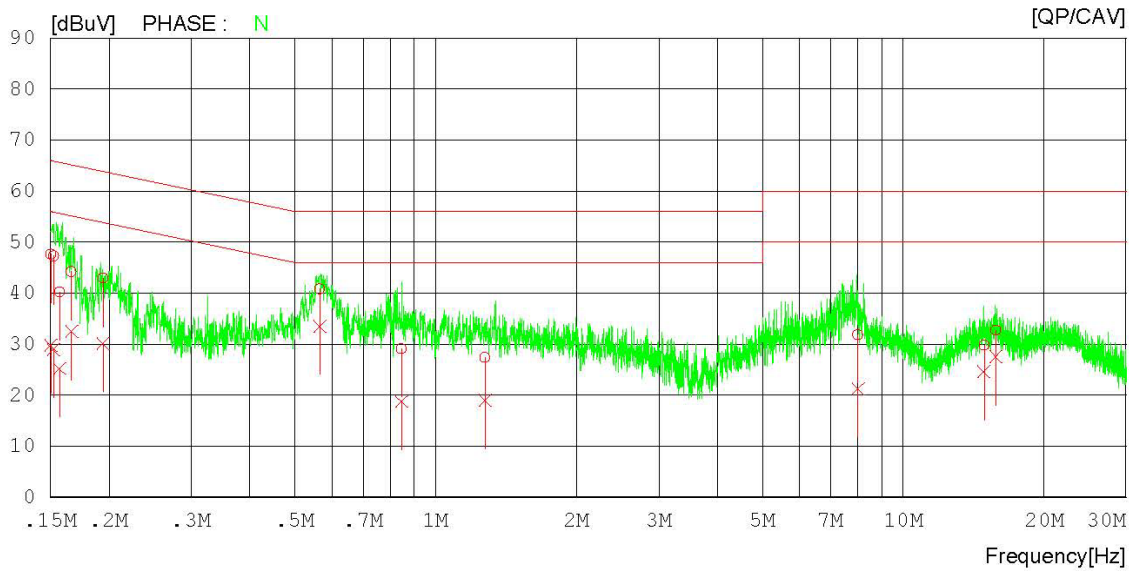

**AC Line Conducted Emissions (List)**

**AC Line Conducted Emission**

DTNC

Date 2018-05-29

Order No. DTNC1801-00692  
 Model No. Aurender SW-TX  
 Serial No.  
 Test Condition SRD

Reference No.  
 Power Supply 120V 60Hz  
 Temp/Humi. 23 °C 44% R.H  
 Operator

Memo

LIMIT : FCC P15.207 QP  
 FCC P15.207 AV

NO	FREQ [MHz]	READING		C. FACTOR [dB]	RESULT		LIMIT		MARGIN		PHASE
		QP [dBuV]	CAV [dBuV]		QP [dBuV]	CAV [dBuV]	QP [dBuV]	CAV [dBuV]			
1	0.15024	37.79	19.93	9.89	47.68	29.82	65.99	55.99	18.31	26.17	N
2	0.15243	37.39	19.08	9.89	47.28	28.97	65.87	55.87	18.59	26.90	N
3	0.15685	30.38	15.33	9.89	40.27	25.22	65.63	55.63	25.36	30.41	N
4	0.16637	34.36	22.58	9.89	44.25	32.47	65.14	55.14	20.89	22.67	N
5	0.19445	33.02	20.31	9.90	42.92	30.21	63.84	53.84	20.92	23.63	N
6	0.56485	30.86	23.61	9.91	40.77	33.52	56.00	46.00	15.23	12.48	N
7	0.84531	19.16	8.84	9.92	29.08	18.76	56.00	46.00	26.92	27.24	N
8	1.27460	17.47	9.06	9.93	27.40	18.99	56.00	46.00	28.60	27.01	N
9	7.99640	21.72	11.15	10.08	31.80	21.23	60.00	50.00	28.20	28.77	N
10	14.88080	19.51	14.40	10.24	29.75	24.64	60.00	50.00	30.25	25.36	N
11	15.77280	22.55	17.31	10.24	32.79	27.55	60.00	50.00	27.21	22.45	N
12	0.15527	34.24	22.46	9.89	44.13	32.35	65.71	55.71	21.58	23.36	L1
13	0.15640	34.56	23.44	9.89	44.45	33.33	65.65	55.65	21.20	22.32	L1
14	0.16760	35.61	21.36	9.89	45.50	31.25	65.08	55.08	19.58	23.83	L1
15	0.20590	34.28	21.39	9.90	44.18	31.29	63.37	53.37	19.19	22.08	L1
16	0.56449	31.52	23.86	9.91	41.43	33.77	56.00	46.00	14.57	12.23	L1
17	0.74940	19.20	8.26	9.92	29.12	18.18	56.00	46.00	26.88	27.82	L1
18	0.81426	18.16	5.92	9.92	28.08	15.84	56.00	46.00	27.92	30.16	L1
19	2.46440	17.60	9.87	9.96	27.56	19.83	56.00	46.00	28.44	26.17	L1
20	2.64480	18.17	8.84	9.97	28.14	18.81	56.00	46.00	27.86	27.19	L1
21	3.27480	15.94	6.69	9.99	25.93	16.68	56.00	46.00	30.07	29.32	L1
22	15.88660	23.07	17.80	10.25	33.32	28.05	60.00	50.00	26.68	21.95	L1
23	21.48280	15.93	10.92	10.30	26.23	21.22	60.00	50.00	33.77	28.78	L1
24	24.92480	12.54	7.55	10.33	22.87	17.88	60.00	50.00	37.13	32.12	L1



### 3.7 Occupied Bandwidth

#### ■ Test Requirements, RSS-Gen [6.7]

When an occupied bandwidth value is not specified in the applicable RSS, the transmitted signal bandwidth to be reported is to be its 99 % emission bandwidth, as calculated or measured.

#### 3.7.1 Test Setup

#### 3.7.2 Test Procedures

The 99 % power bandwidth was measured with a calibrated spectrum analyzer.

The resolution bandwidth (RBW) shall be in the range of 1 % to 5 % of the occupied bandwidth (OBW) and video bandwidth (VBW) shall be approximately 3 × RBW.

Spectrum analyzer plots are included on the following pages.

#### 3.7.3 Test Results

-NA

## 4. ANTENNA REQUIREMENTS

■ **According to FCC 47 CFR §15.203**

“An intentional radiator antenna shall be designed to ensure that no antenna other than that furnished by the responsible party can be used with the device. The use of a permanently attached antenna or of an antenna that uses a unique coupling to the intentional radiator shall be considered sufficient to comply with the provisions of this section.”

**The antenna is permanently attached on the device. (Chip Antenna)  
Therefore this E.U.T Complies with the requirement of §15.203**

# APPENDIX I

## Test set up diagrams

### ▪ Radiated Measurement

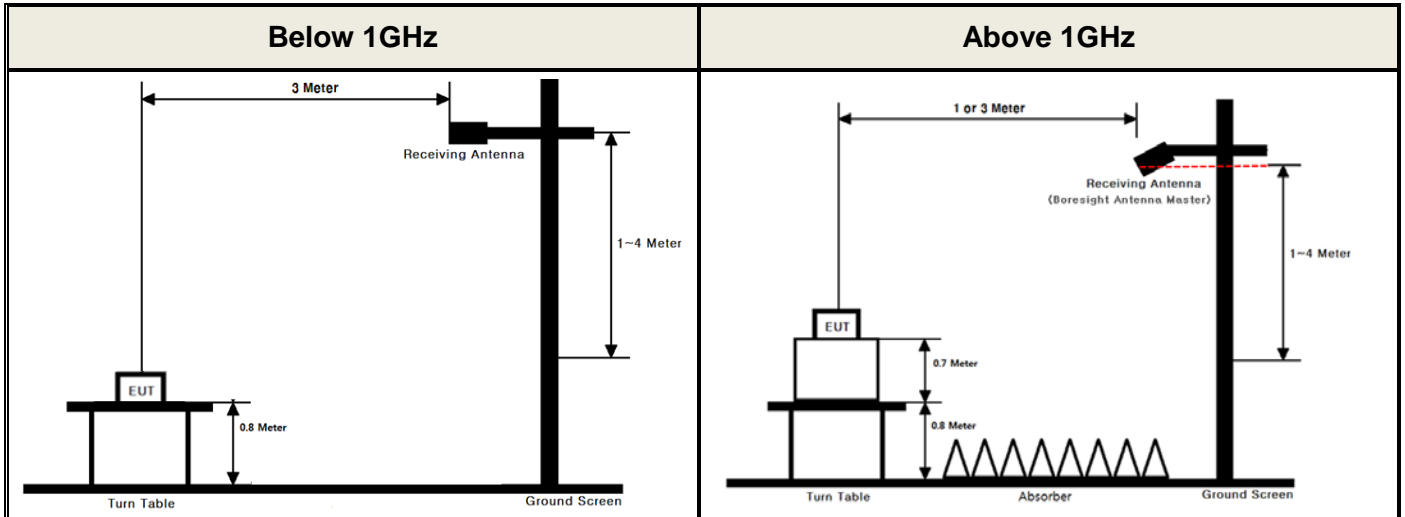

### ▪ Conducted Measurement

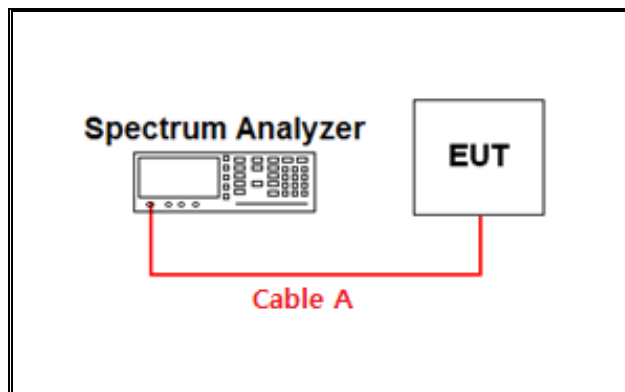

Path loss information

Frequency (GHz)	Path Loss (dB)	Frequency (GHz)	Path Loss (dB)
0.03	0.42	15	3.89
1	0.49	20	4.26
2.406 & 2.440 & 2.476	1.28	25	4.39
5	2.21	-	-
10	2.92	-	-

Note 1: The path loss from EUT to Spectrum analyzer were measured and used for test.

Path loss ( S/A's Correction factor) = Cable A

## APPENDIX II

### Duty cycle plots

#### ▪ Test Procedure

Duty Cycle was measured using **Section 6.0 b) of KDB558074 D01v04** :

The zero-span mode on a spectrum analyzer or EMI receiver if the response time and spacing between bins on the sweep are sufficient to permit accurate measurements of the on and off times of the transmitted signal. Set the center frequency of the instrument to the center frequency of the transmission. Set  $RBW \geq OBW$  if possible; otherwise, set RBW to the largest available value. Set  $VBW \geq RBW$ . Set detector = peak or average.

The zero-span measurement method shall not be used unless both RBW and VBW are  $> 50/T$  and the number of sweep points across duration T exceeds 100. (For example, if VBW and/or RBW are limited to 3 MHz, then the zero-span method of measuring duty cycle shall not be used if  $T \leq 16.7$  microseconds.)

### Duty Cycle

TM 1 Test Channel : Middle

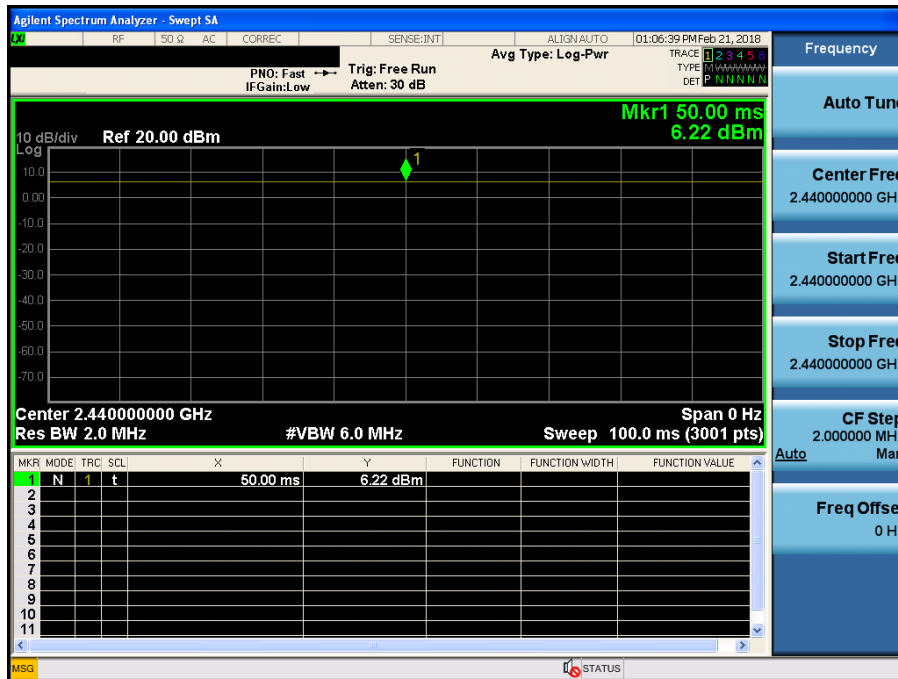

APPENDIX III

Unwanted Emissions (Radiated) Test Plot

TM1 & Lowest & Z & Hor

Detector Mode : PK

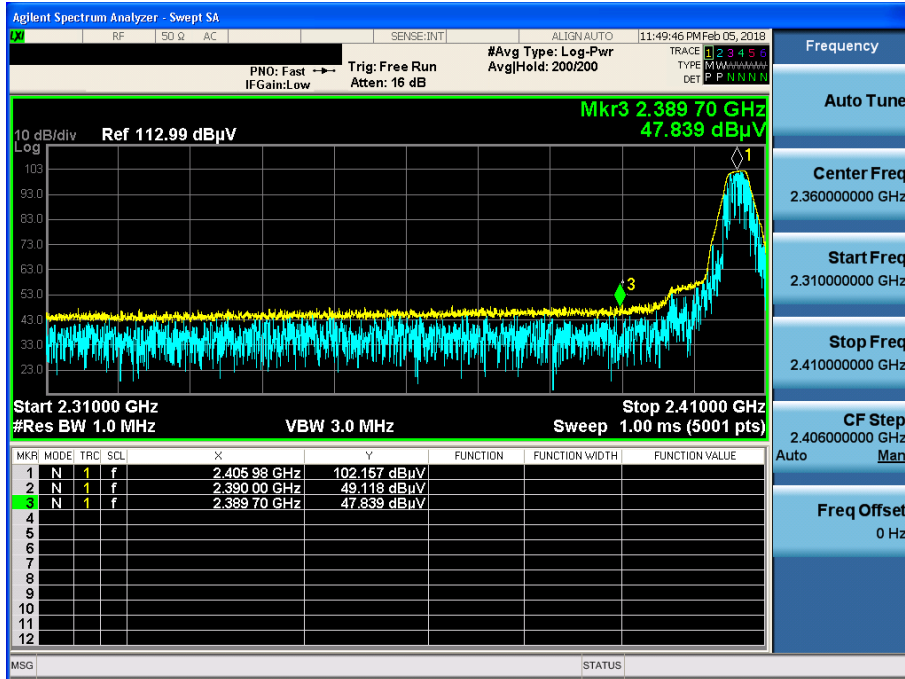

TM1 & Lowest & Z & Hor

Detector Mode : AV

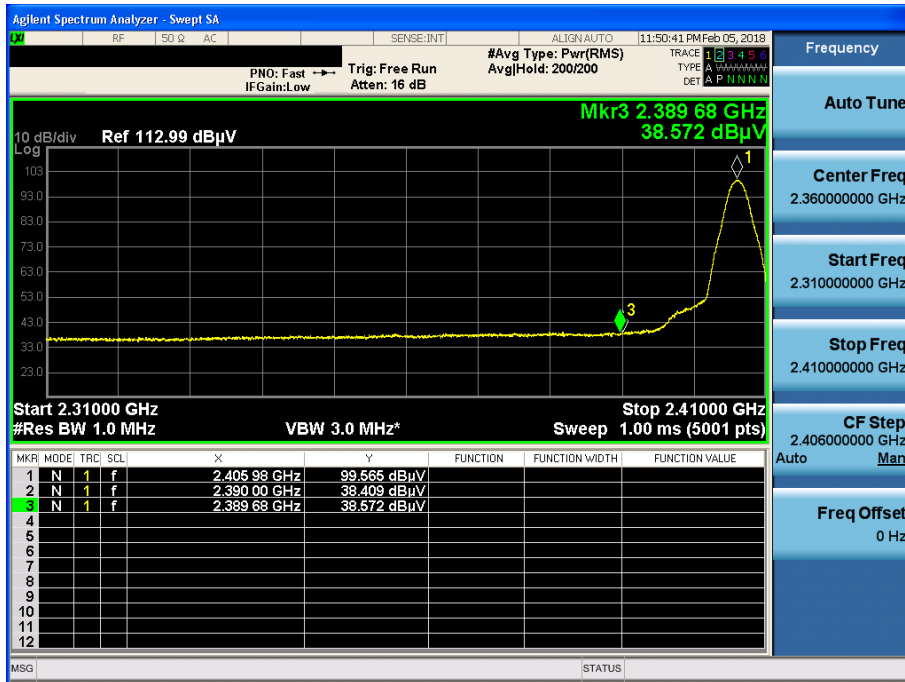

TM1 & Highest & Z & Hor

Detector Mode : PK

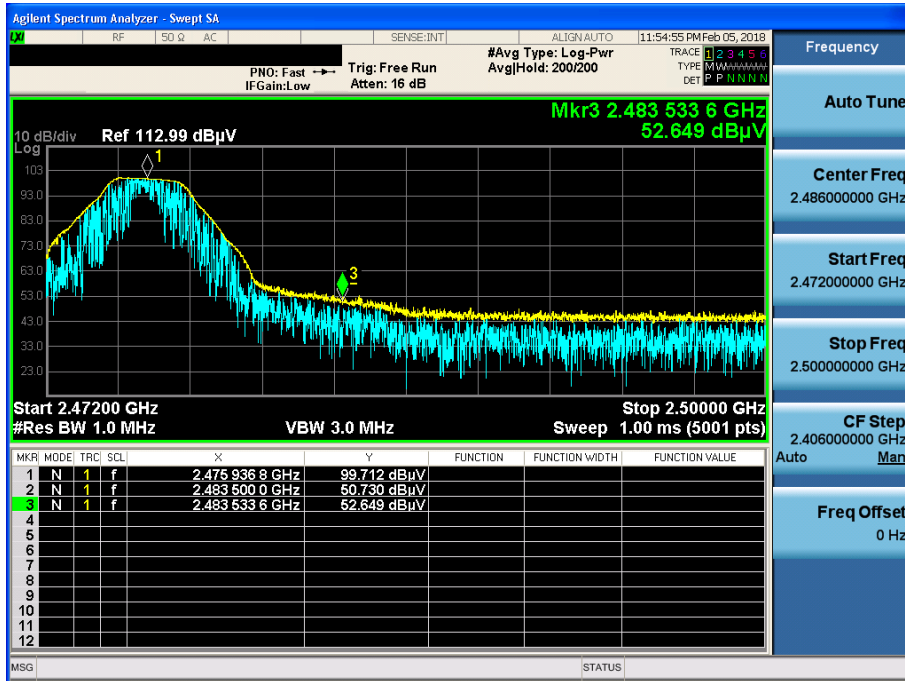

TM1 & Highest & Z & Hor

Detector Mode : AV

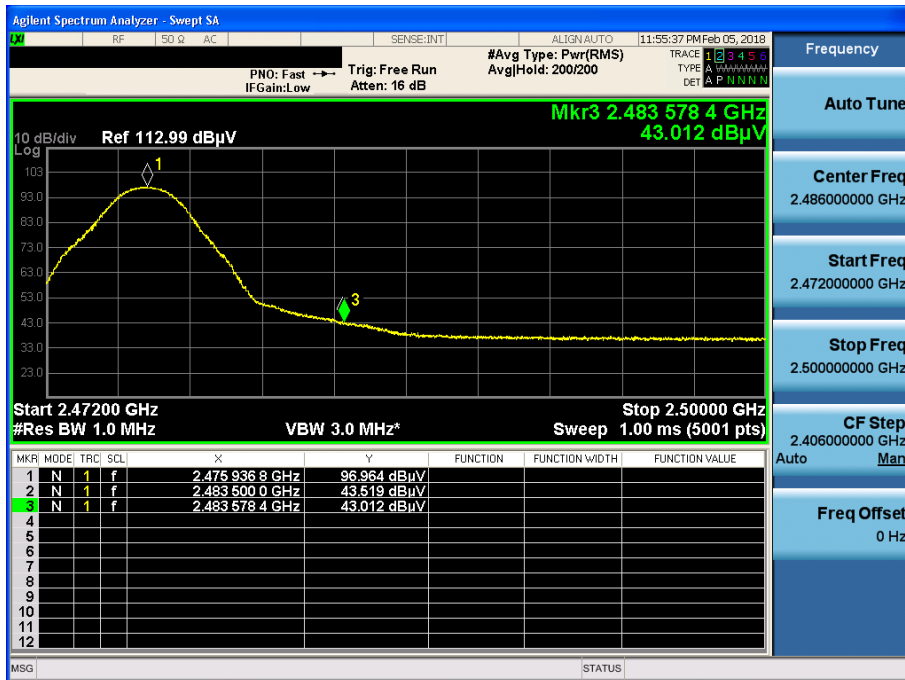

TM1 & Middle & Z & Ver

Detector Mode : AV

